

**Boost Controller for WLED Driver in Medium-sized LCD Panel AP3041**

## General Description

The AP3041 is a current mode high voltage low-side channel MOSFET controller, which is ideal for boost regulators. It contains all the features needed to implement single-ended primary topology DC/DC converters.

The input voltage of AP3041 ranges from 5V to 27V. Its operation frequency is adjustable from 100kHz to 1MHz.

The AP3041 has UVLO (Under Voltage Lock Out) circuit. It uses two external resistors to set the UVLO voltage. The AP3041 also has an over output voltage protection to limit the output voltage. The OVP voltage can be set through external resistors. If the output voltage is higher than the OVP high threshold point, it will disable the driver and the system is latched up. The output short circuit protection as well as LED low side short to ground detection function can be applied in system.

The AP3041 has other protection functions, such as LED short protection, LED high side short to ground protection, diode short protection, over current protection, over temperature protection and so on.

The AP3041 is available in SOIC-16 package.

## Features

- Input Voltage Range: 5V to 27V
- 1A Peak and 10V MOSFET Gate Driver
- 20ns Quick MOSFET Gate Driver
- Duty Cycle Limit of 90%
- Programmable UVLO
- PWM Dimming Control
- Programmable Over Voltage Protection
- LED Open Protection
- LED Short Circuit Protection
- Diode Short Circuit Protection
- Output Short Circuit Protection
- LED Low-side Short to Ground Detection
- OV Pin Under Voltage Protection
- Over Current Protection
- Programmable Slope Compensation
- Adjustable Soft-start
- Adjustable Protection Delay
- Fault Status Indication
- Adjustable Operation Frequency from 100kHz to 1MHz
- Over Temperature Protection

## Applications

- LED Lighting
- LED TV
- LCD Display Modules

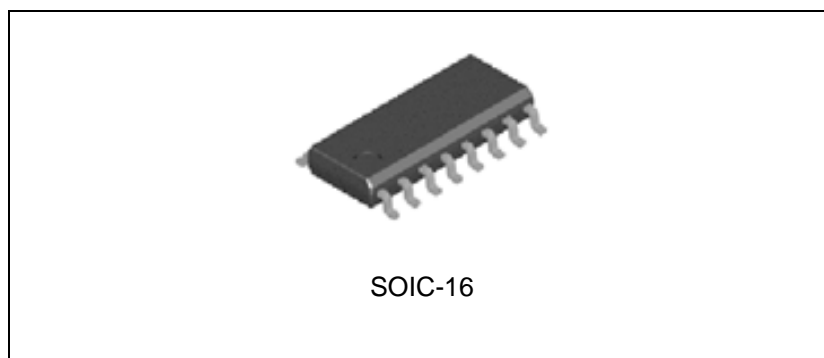

Figure 1. Package Type of AP3041

**Boost Controller for WLED Driver in Medium-sized LCD Panel AP3041****Pin Configuration**

Figure 2. Pin Configuration of AP3041 (Top View)

**Boost Controller for WLED Driver in Medium-sized LCD Panel AP3041****Pin Description**

Pin Number	Pin Name	Function
1	CT	Capacitor setting shut down delay time
2	OV	Over output voltage protection pin
3	UVLO	Two resistors connected from this pin to GND and the power supply respectively are used to set start-up and shutdown level
4	EN	Enable pin
5	VIN	Input supply pin. This pin must be locally bypassed
6	VCC	This pin should be bypassed to GND with a ceramic capacitor
7	OUT	Connect this pin to the gate of external MOSFET, the gate driver has 1A peak current capability
8	GND	Ground
9	FAULT	This pin can be used to drive the external MOSFET. The logic of the driver signal is controlled by that of PWM pin and the signal phase of them is the same. This pin is pulled to ground under fault condition of OVP, UVLO, OTP, diode short circuit and LED short circuit.
10	RT	An external resistor connected from this pin to GND is used to set the operating frequency
11	CS	Sense switch current pin, which is used for current mode control and for current limit. The current limit voltage is 500mV
12	SC	Slope compensation for current sense. A resistor between SC and GND will program the slope compensation
13	SS/COMP	An external soft-start time capacitor is placed from this pin to GND and is charged by an internal 20 $\mu$ A current source to control regulator soft-start time. Compensation pin. This pin is the output of the internal error amplifier.
14	FB	Voltage feedback pin. The reference voltage is 500mV
15	PWM	This pin can be connected to current matched chip and receives error signal used to shut down the system
16	FLAG	Fault condition output pin. When the output is in short circuit condition, the FLAG outputs logic low to shut down the power path. Please refer to the application circuit

**Boost Controller for WLED Driver in Medium-sized LCD Panel AP3041**

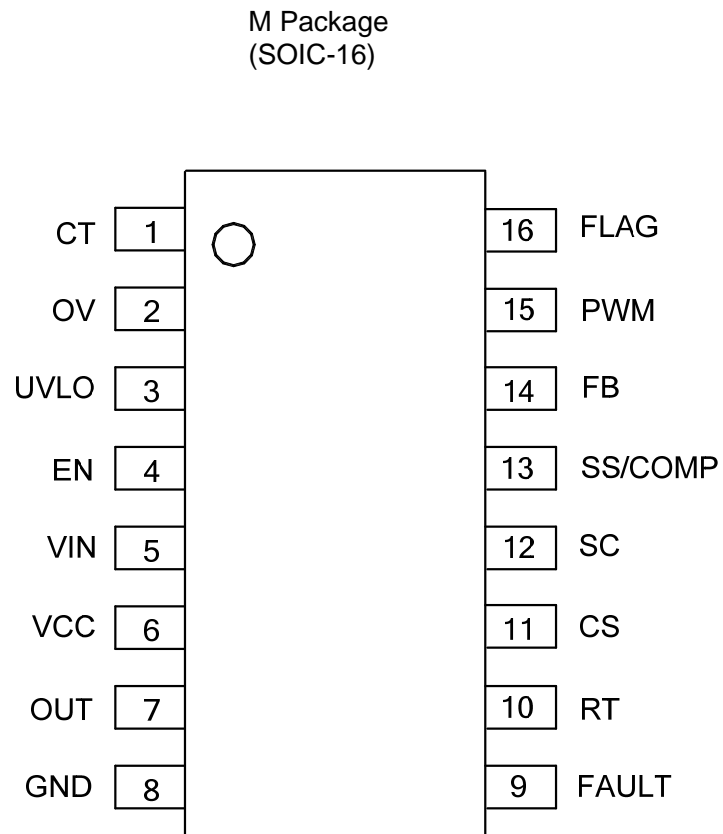
**Functional Block Diagram**

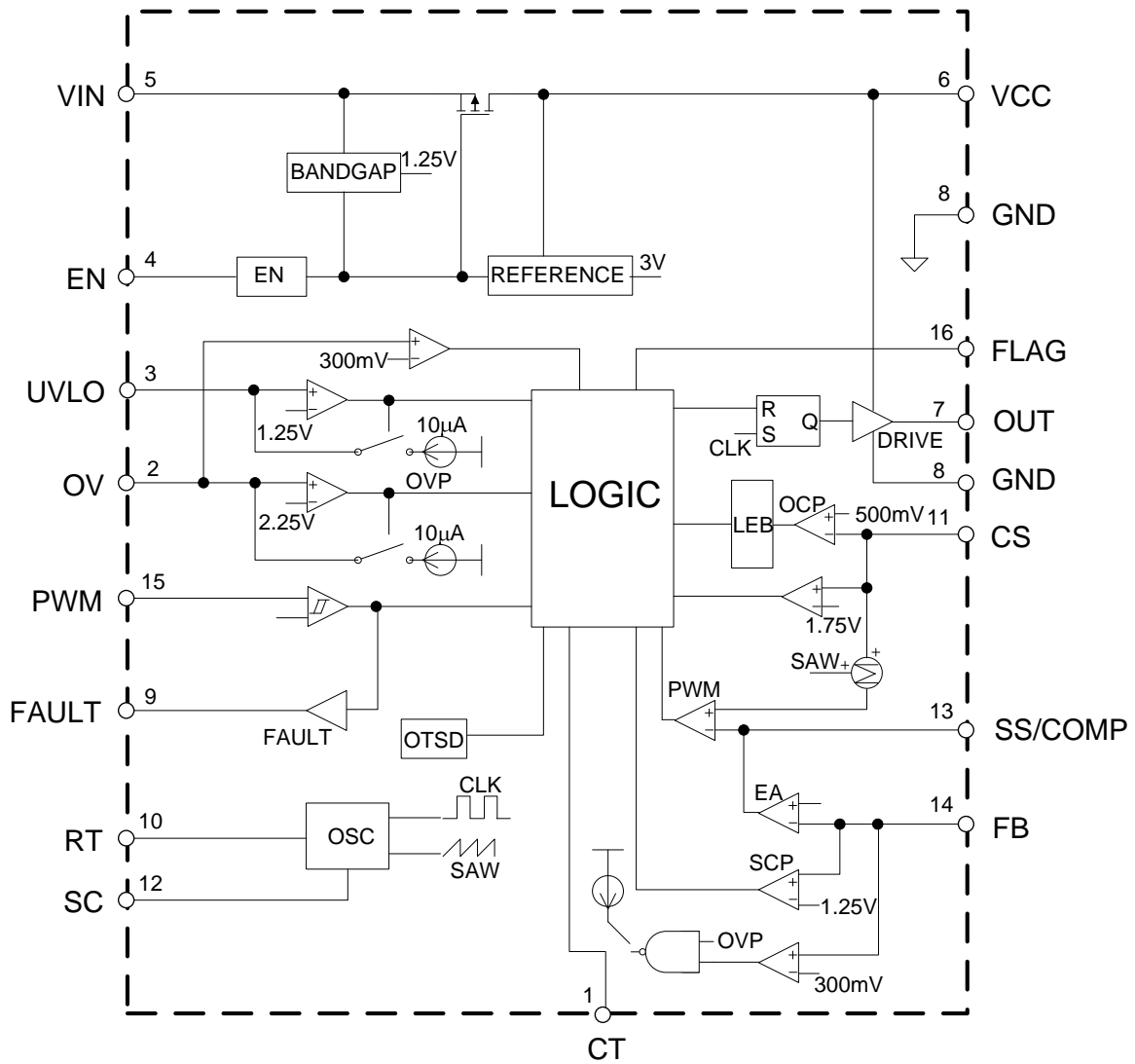
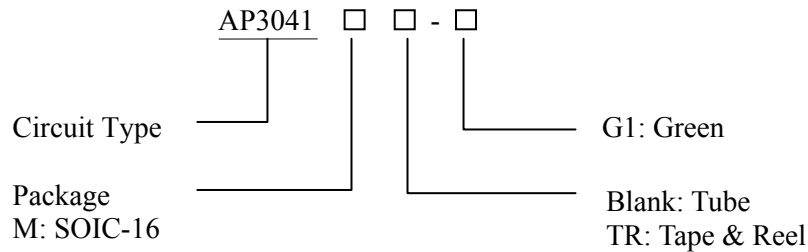

Figure 3. Functional Block Diagram of AP3041

**Boost Controller for WLED Driver in Medium-sized LCD Panel AP3041**
**Ordering Information**

Package	Temperature Range	Part Number	Marking ID	Packing Type
SOIC-16	-40 to 85°C	AP3041M-G1	AP3041M-G1	Tube
		AP3041MTR-G1	AP3041M-G1	Tape & Reel

BCD Semiconductor's Pb-free products, as designated with "G1" suffix in the part number, are RoHS compliant and green.

**Absolute Maximum Ratings (Note 1)**

Parameter	Symbol	Value	Unit
Input Voltage	$V_{IN}$	30	V
VCC Pin Voltage	$V_{CC}$	20	V
OUT Pin Voltage	$V_{OUT}$	20	V
FAULT Pin Voltage	$V_{FAULT}$	20	V
FB Pin Voltage	$V_{FB}$	20	V
UVLO Pin Voltage	$V_{UVLO}$	7	V
CS Pin Voltage	$V_{CS}$	20	V
SC Pin Voltage	$V_{SC}$	7	V
FLAG Pin Voltage	$V_{FLAG}$	7	V
SS/COMP Pin Voltage	$V_{SS/COMP}$	7	V
RT Pin Voltage	$V_{RT}$	7	V
PWM Pin Voltage	$V_{PWM}$	7	V
EN Pin Voltage	$V_{EN}$	30	V
OV Pin Voltage	$V_{OV}$	7	V
Thermal Resistance (Junction to Ambient, No Heat Sink, Free Air)	$\theta_{JA}$	82	°C/W

**Boost Controller for WLED Driver in Medium-sized LCD Panel AP3041****Absolute Maximum Ratings (Note 1, Continued)**

Parameter	Symbol	Value	Unit
Operating Junction Temperature	$T_J$	150	°C
Storage Temperature	$T_{STG}$	-65 to 150	°C
Lead Temperature (Soldering, 10 sec)	$T_{LEAD}$	260	°C
ESD (Human Body Model)		2000	V
ESD (Machine Model)		200	V

Note 1: Stresses greater than those listed under “Absolute Maximum Ratings” may cause permanent damage to the device. These are stress ratings only, and functional operation of the device at these or any other conditions beyond those indicated under “Recommended Operating Conditions” is not implied. Exposure to “Absolute Maximum Ratings” for extended periods may affect device reliability.

**Recommended Operating Conditions**

Parameter	Symbol	Min	Max	Unit
Input Voltage	$V_{IN}$	5	27	V
Operating Frequency	$f$	0.1	1	MHz
Operating Temperature Range	$T_J$	-40	85	°C

**Electrical Characteristics**

$V_{CC}=12V$ ,  $V_{EN}=3.3V$ ,  $T_A=25^\circ C$ , unless otherwise specified.

Parameter	Symbol	Conditions	Min	Typ	Max	Unit
Input Voltage	$V_{IN}$		5		27	V
Feedback Voltage	$V_{FB}$		490	500	510	mV
Supply Current	$I_{CC}$	$V_{FB}=V_{IN}$ , no switching		1.5	5	mA
Shutdown Supply Current	$I_Q$	$V_{EN}=0$		1	2	μA
VCC Voltage	$V_{CC}$	$11V \leq V_{IN} \leq 27V$	9.5	10.0	10.5	V
		$5V \leq V_{IN} \leq 10V$ , $I_{CC}=5mA$	$V_{IN}-0.5$			V
VCC Current Limit	$I_{CC-LIM}$			35		mA
VCC Pin UVLO Rising Threshold	$V_{CC-HI}$			4.7		V
VCC Pin UVLO Falling Hysteresis	$V_{CC-HYS}$			300		mV
Oscillator Frequency	$f_{OSC}$		0.1		1	MHz
SC Peak Voltage	$V_{SC\_PK}$		530		680	mV
UVLO Threshold	$V_{UVLO}$		1.20	1.25	1.30	V
UVLO Hysteresis Current Source	$I_{UVLO-HYS}$			10		μA

**Boost Controller for WLED Driver in Medium-sized LCD Panel AP3041****Electrical Characteristics (Continued)**

$V_{CC}=12V$ ,  $V_{EN}=3.3V$ ,  $T_A=25^{\circ}C$ , unless otherwise specified.

Parameter	Symbol	Conditions	Min	Typ	Max	Unit
Current Limit Threshold Voltage	$V_{CS}$		0.48	0.5	0.52	V
RT Voltage	$V_{RT}$		1.20	1.25	1.30	V
Error Amplifier Voltage Gain	$G_V$			680		V/V
Error Amplifier Transconductance	$G_S$			500		$\mu A/V$
EN Pin Threshold Voltage	$V_{EH}$		2.5			V
	$V_{EL}$				0.5	
PWM Pin Threshold Voltage	$V_{IH}$		2.5			V
	$V_{IL}$				0.5	
OV Threshold	$V_{OV}$			2.25		V
OV Hysteresis Current Source	$I_{OV-HYS}$			10		$\mu A$
LED- Short to GND Detection Level	$V_{FB\_LOW}$			0.3		V
LED+ Short to LED-Detection Level	$V_{FB\_HIGH}$			1.25		V
LED+ Short to GND Detection Level	$V_{OV\_LOW}$			0.3		V
Diode Short Detection Level	$V_{CS\_HIGH}$			1.75		V
CT Current Source	$I_{CT}$			5		$\mu A$
CT Threshold Voltage	$V_{CT}$			2.6		V
Maximum Duty Cycle	$D_{MAX}$	$f=200kHz$	80	90		%
Soft-start Current Source	$I_{SS}$		16	22	28	$\mu A$
OUT Pin Rising Time	$t_{RISE}$	$C_{OUT}=1nF$		20		ns
OUT Pin Falling Time	$t_{FALL}$	$C_{OUT}=1nF$		20		
OUT High Voltage Level ( $V_{CC}-V_{OUT}$ )	$V_{OUT-H}$	$I_{OUT}=50mA$		0.25	0.75	V
OUT Low Voltage Level ( $V_{OUT}$ )	$V_{OUT-L}$	$I_{OUT}=50mA$		0.25	0.75	V
FAULT Pin Rising Time	$t_{RISE}$	$C_{FAULT}=1nF$		100		ns
FAULT Pin Falling Time	$t_{FALL}$	$C_{FAULT}=1nF$		100		
FAULT High Voltage Level ( $V_{CC}-V_{FAULT}$ )	$V_{FAULT\_H}$	$I_{FAULT}=10mA$		0.25	0.75	V
FAULT Low Voltage Level	$V_{FAULT\_L}$	$I_{FAULT}=10mA$		0.25	0.75	V
FAULT Minimum Pulse Width	$t_D$	Oscillator Frequency=200kHz		20		$\mu s$
FLAG High Voltage Level	$V_{FLAG-H}$	$I_{FLAG}=500\mu A$		2		V
FLAG Low Voltage Level	$V_{FLAG-L}$	$I_{FLAG}=500\mu A$		0.25	0.75	V
Thermal Shutdown Temperature	$T_{OTSD}$			160		$^{\circ}C$
Thermal Shutdown Hysteresis	$T_{HYS}$			20		$^{\circ}C$

**Boost Controller for WLED Driver in Medium-sized LCD Panel AP3041**

**Typical Performance Characteristics**

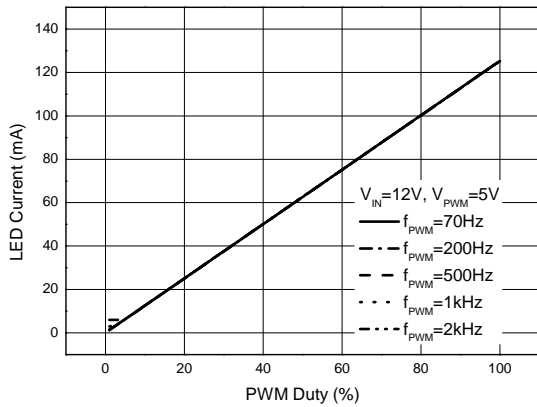

Figure 4. LED Current vs. PWM Duty

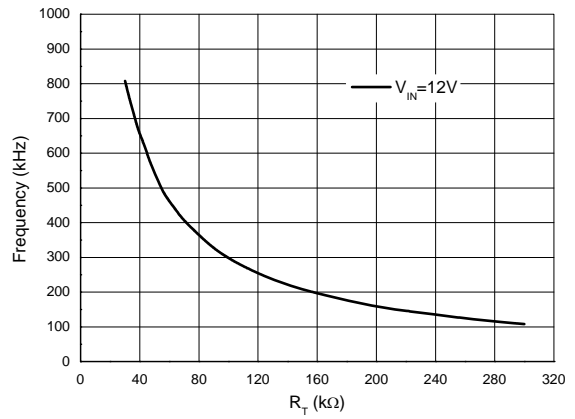

Figure 5. Frequency vs.  $R_T$

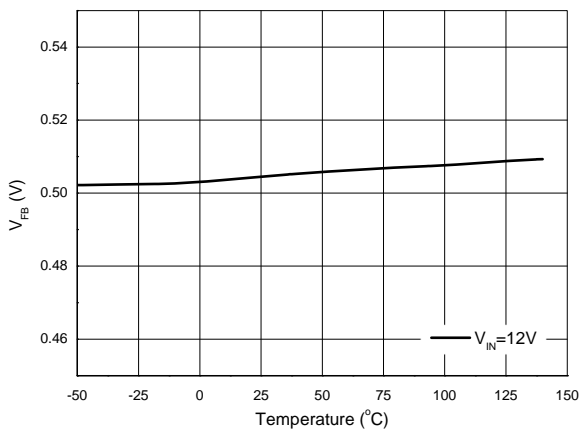

Figure 6.  $V_{FB}$  vs. Temperature

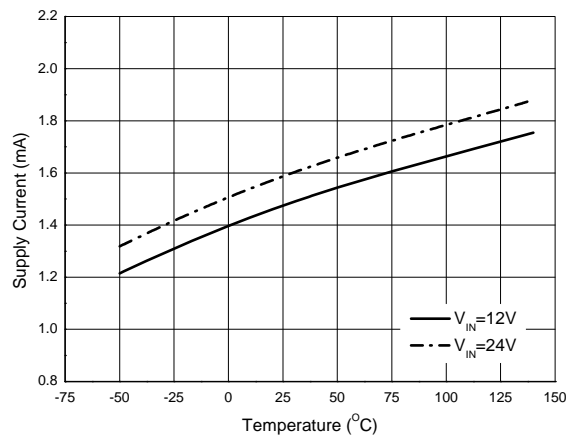

Figure 7. Supply Current vs. Temperature



**Boost Controller for WLED Driver in Medium-sized LCD Panel AP3041**

**Typical Performance Characteristics (Continued)**

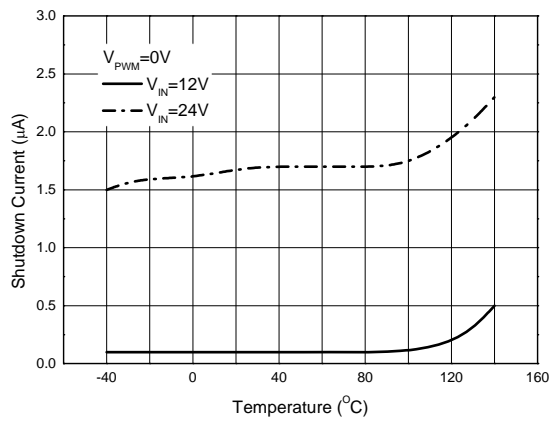

Figure 8. Supply Current vs. Temperature

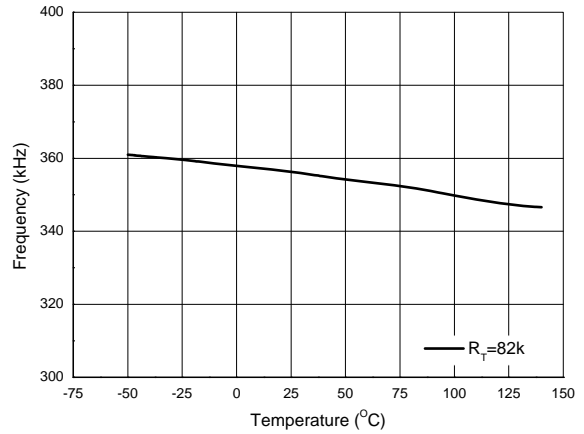

Figure 9. Frequency vs. Temperature

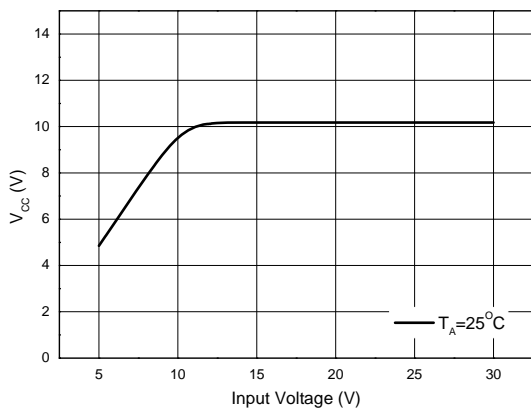

Figure 10. V<sub>CC</sub> vs. Input Voltage

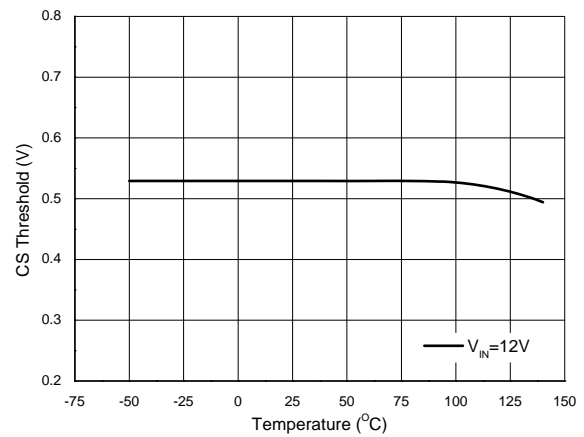

Figure 11. CS Threshold vs. Temperature

**Boost Controller for WLED Driver in Medium-sized LCD Panel AP3041**

**Typical Performance Characteristics (Continued)**

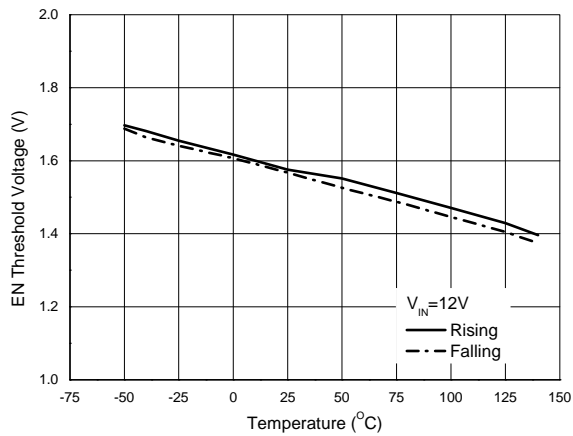

Figure 12. EN Threshold Voltage vs. Temperature

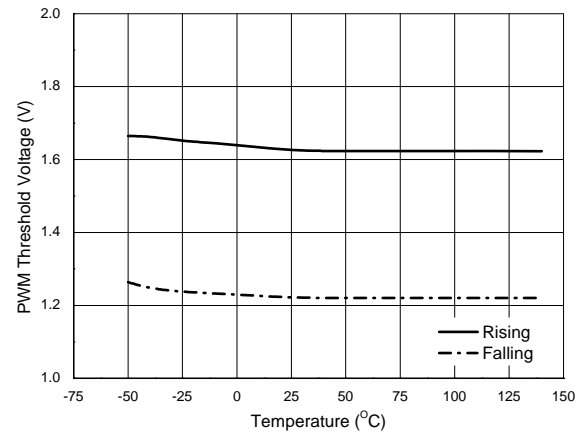

Figure 13. PWM Threshold Voltage vs. Temperature

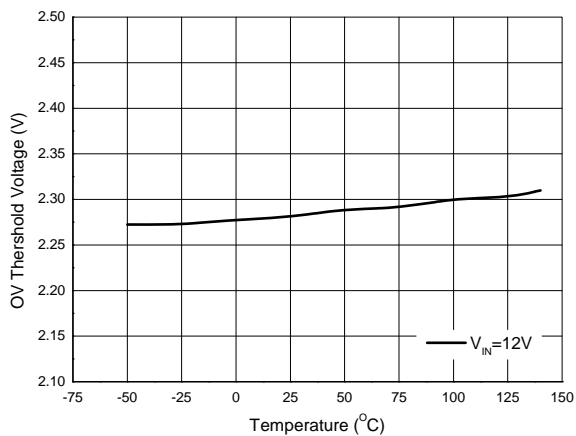

Figure 14. OV Threshold Voltage vs. Temperature

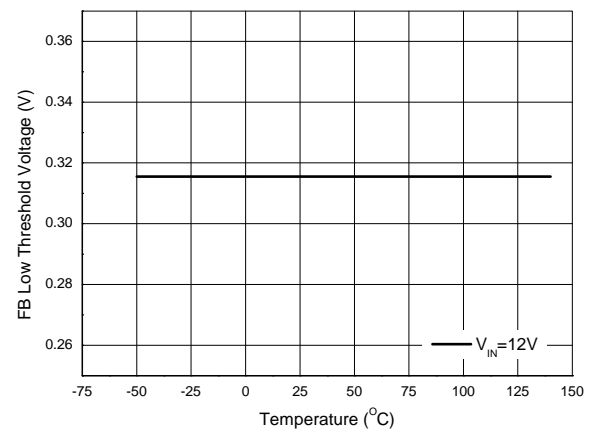

Figure 15. FB Low Threshold Voltage vs. Temperature

**Boost Controller for WLED Driver in Medium-sized LCD Panel AP3041**

**Typical Performance Characteristics (Continued)**

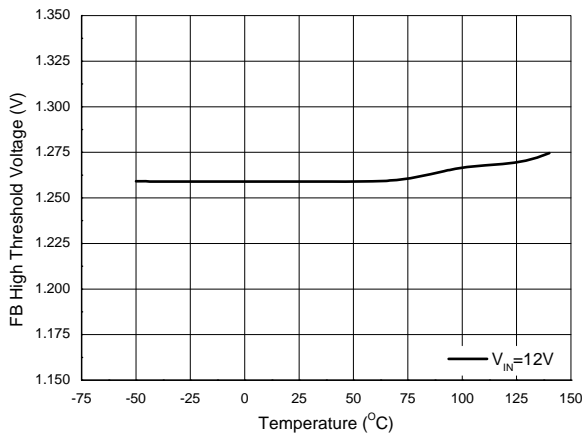

Figure 16. FB High Threshold Voltage vs. Temperature

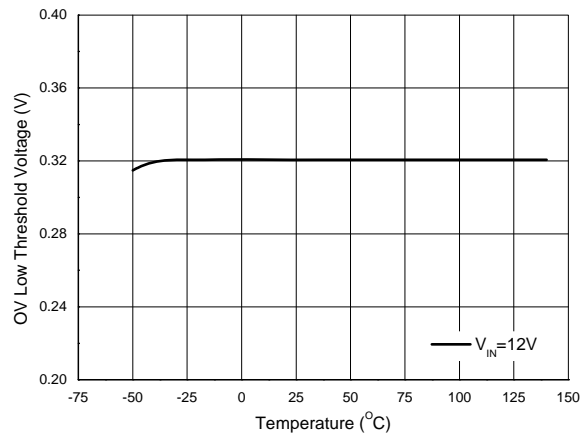

Figure 17. OV Low Threshold Voltage vs. Temperature

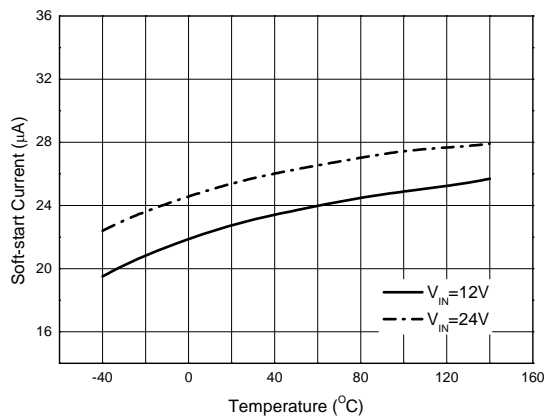

Figure 18. Soft-start Current vs. Temperature

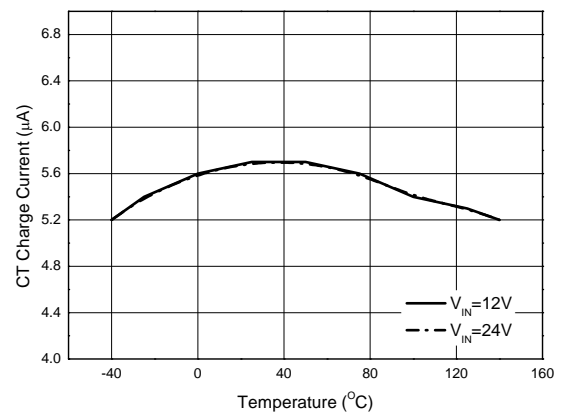

Figure 19. CT Charge Current vs. Temperature

**Boost Controller for WLED Driver in Medium-sized LCD Panel AP3041**

**Typical Application**

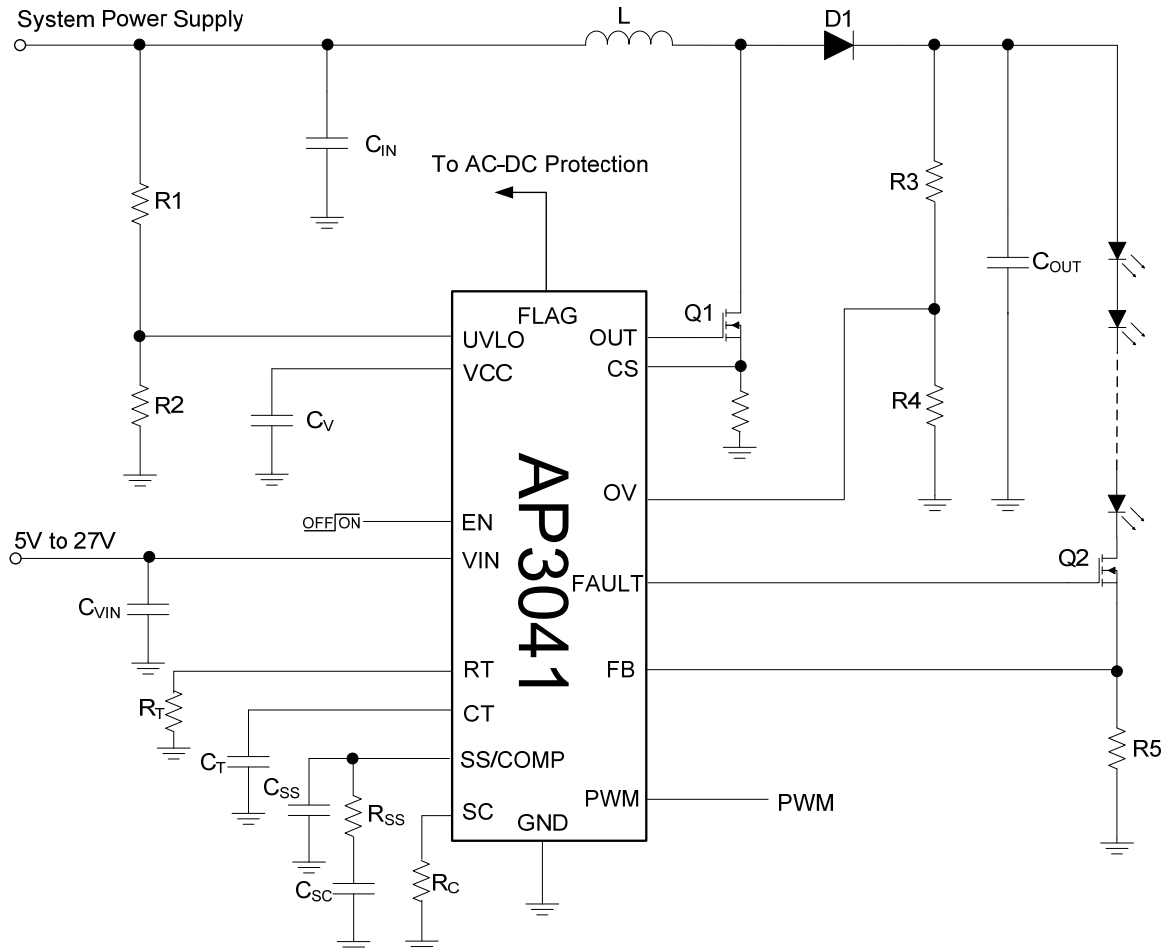

Figure 20. Typical Application Circuit of AP3041

**Boost Controller for WLED Driver in Medium-sized LCD Panel AP3041**

**Mechanical Dimensions**

**SOIC-16**

**Unit: mm(inch)**

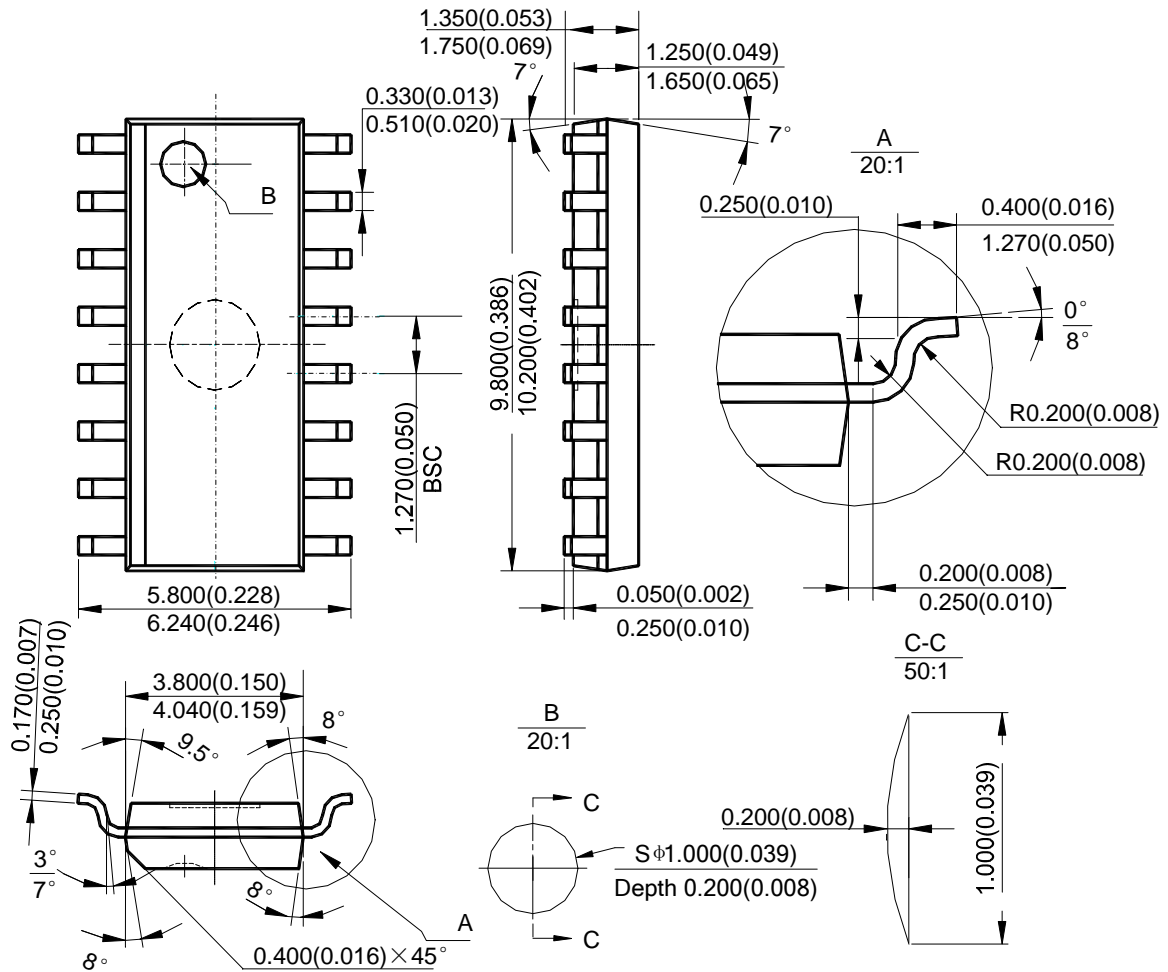

Note: Eject hole, oriented hole and mold mark is optional.



## **BCD Semiconductor Manufacturing Limited**

<http://www.bcdsemi.com>

### **IMPORTANT NOTICE**

BCD Semiconductor Manufacturing Limited reserves the right to make changes without further notice to any products or specifications herein. BCD Semiconductor Manufacturing Limited does not assume any responsibility for use of any its products for any particular purpose, nor does BCD Semiconductor Manufacturing Limited assume any liability arising out of the application or use of any its products or circuits. BCD Semiconductor Manufacturing Limited does not convey any license under its patent rights or other rights nor the rights of others.

---

#### **MAIN SITE**

##### **- Headquarters**

##### **BCD Semiconductor Manufacturing Limited**

No. 1600, Zi Xing Road, Shanghai Zizhu Science-based Industrial Park, 200241, China  
Tel: +86-21-24162266, Fax: +86-21-24162277

##### **- Wafer Fab**

##### **Shanghai SIM-BCD Semiconductor Manufacturing Co., Ltd.**

800 Yi Shan Road, Shanghai 200233, China  
Tel: +86-21-6485 1491, Fax: +86-21-5450 0008

#### **REGIONAL SALES OFFICE**

##### **Shenzhen Office**

##### **Shanghai SIM-BCD Semiconductor Manufacturing Co., Ltd., Shenzhen Office**

Unit A Room 1203, Skyworth Bldg., Gaoxin Ave. 1.S., Nanshan District, Shenzhen, China  
Tel: +86-755-8826 7951  
Fax: +86-755-8826 7865

##### **Taiwan Office**

##### **BCD Semiconductor (Taiwan) Company Limited**

4F, 298-1, Rui Guang Road, Nei-Hu District, Taipei, Taiwan  
Tel: +886-2-2656 2808  
Fax: +886-2-2656 2806

##### **USA Office**

##### **BCD Semiconductor Corp.**

30920 Huntwood Ave. Hayward, CA 94544, USA  
Tel : +1-510-324-2988  
Fax: +1-510-324-2788



## Стандарт Электрон Связь

Мы молодая и активно развивающаяся компания в области поставок электронных компонентов. Мы поставляем электронные компоненты отечественного и импортного производства напрямую от производителей и с крупнейших складов мира.

Благодаря сотрудничеству с мировыми поставщиками мы осуществляем комплексные и плановые поставки широчайшего спектра электронных компонентов.

Собственная эффективная логистика и склад в обеспечивает надежную поставку продукции в точно указанные сроки по всей России.

Мы осуществляем техническую поддержку нашим клиентам и предпродажную проверку качества продукции. На все поставляемые продукты мы предоставляем гарантию .

Осуществляем поставки продукции под контролем ВП МО РФ на предприятия военно-промышленного комплекса России , а также работаем в рамках 275 ФЗ с открытием отдельных счетов в уполномоченном банке. Система менеджмента качества компании соответствует требованиям ГОСТ ISO 9001.

Минимальные сроки поставки, гибкие цены, неограниченный ассортимент и индивидуальный подход к клиентам являются основой для выстраивания долгосрочного и эффективного сотрудничества с предприятиями радиоэлектронной промышленности, предприятиями ВПК и научно-исследовательскими институтами России.

С нами вы становитесь еще успешнее!

### Наши контакты:

**Телефон:** +7 812 627 14 35

**Электронная почта:** [sales@st-electron.ru](mailto:sales@st-electron.ru)

**Адрес:** 198099, Санкт-Петербург,  
Промышленная ул, дом № 19, литера Н,  
помещение 100-Н Офис 331