

# Slide Switch 8.5(H)mm, 3mm-travel Type

## SSSU Series

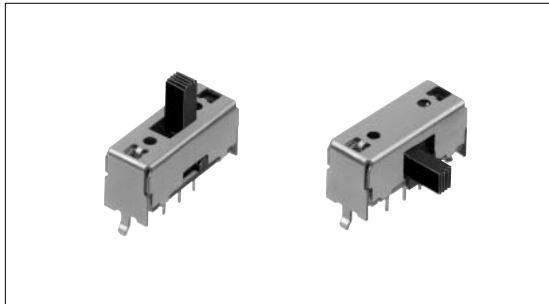

Large-size general purpose type with various knobs.



### Typical Specifications

Items		Specifications
Rating (max.) (min.) (Resistive load)		0.1A 30V DC/50 $\mu$ A 3V DC
Contact resistance (Initial performance/After lifetime)		25m max./65m max.
Operating force		Refer to the dimensions.
Operating life	Without load	10,000cycles
	With load	10,000cycles( 0.1A 30V DC )

Detector

Push

**Slide**

Rotary

Encoders

Power

Dual-in-line  
Package Type

TACT Switch™

Custom-  
Products

Small size  
General Use type

**Big size  
General Use type**

Other Use type

### Product Line

Travel (mm)	Actuator direction	Actuator length (mm)	Poles	Positions	Mounting method	Changeover timing	Soldering	Minimum order unit (pcs.)	Products No.	Drawing No.
3	Vertical	6	1	2	Snap-in (t1.6)	Non shorting	Manual, Dip	2,000	SSSU011700	1
		9							SSSU012200	
		6		3				2,500	SSSU014800	2
		9							SSSU015100	
		6	2	2				2,000	SSSU022400	3
		9							SSSU022800	
		6		3				2,500	SSSU025800	4
		9							SSSU026300	
	6	2	5	SSSU041700						
	9			SSSU042100						
	Horizontal	6	1	3				3,500	SSSU111400	6
				3					SSSU113200	7
			2	3,500					SSSU121700	8
		2	SSSU122200							
9		2	3	2,000	SSSU124900	9				

### Notes

1. Products other than those listed in the above chart are also available. Please contact us for details.
2. Please contact us for automotive use.
3. Please place purchase orders per minimum order unit(integer).

Dimensions

Vertical Actuator Type

Unit:mm

No.	Style	PC board mounting hole dimensions ( Viewed from the direction A )
1	<p><b>1-pole, 2-positions</b></p> <p>Operating force with detent : 2N</p>	
2	<p><b>1-pole, 3-positions</b></p> <p>Operating force with detent : a → b, c → b } 1.5N    b → a, b → c } 2N</p>	
3	<p><b>2-poles, 2-positions</b></p> <p>Operating force with detent : 2N</p>	
4	<p><b>2-poles, 3-positions</b></p> <p>Operating force with detent : a → b, c → b } 1.5N    b → a, b → c } 2N</p>	
5	<p><b>4-poles, 2-positions</b></p> <p>Operating force with detent : 2N</p>	

- Detector
- Push
- Slide
- Rotary
- Encoders
- Power
- Dual-in-line Package Type
- TACT Switch™
- Custom-Products
- Small size General Use type
- Big size General Use type
- Other Use type

**Dimensions**

Horizontal Actuator Type

Unit:mm

No.	Style	PC board mounting hole dimensions (Viewed from the direction A)
6	<p><b>1-pole, 2-positions</b></p> <p>PC board mounting face</p> <p>Terminal No.①</p> <p>Operating force with detent : 2N</p>	<p>3-<math>\phi</math>0.7 holes</p>
7	<p><b>1-pole, 3-positions</b></p> <p>PC board mounting face</p> <p>Terminal No.①</p> <p>Operating force with detent :  <math>a \rightarrow b</math>  <math>c \rightarrow b</math> } 1.5N      <math>b \rightarrow a</math> } 2N  <math>b \rightarrow c</math> }</p>	<p>5-<math>\phi</math>0.7 holes</p>
8	<p><b>2-poles, 2-positions</b></p> <p>PC board mounting face</p> <p>Terminal No.①</p> <p>Operating force with detent : 2N</p>	<p>6-<math>\phi</math>0.7 holes</p>
9	<p><b>2-poles, 3-positions</b></p> <p>PC board mounting face</p> <p>Terminal No.①</p> <p>Operating force with detent :  <math>a \rightarrow b</math>  <math>c \rightarrow b</math> } 1.5N      <math>b \rightarrow a</math> } 2N  <math>b \rightarrow c</math> }</p>	<p>10-<math>\phi</math>0.7 holes</p>

# Slide Switch 8.5(H)mm, 3mm-travel Type | SSSU Series

Detector

Push

Slide

Rotary

Encoders

Power

Dual-in-line  
Package Type

TACT Switch™

Custom-  
Products

Small size  
General Use type

Big size  
General Use type

Other Use type

## Circuit Diagram (Viewed from Direction A)

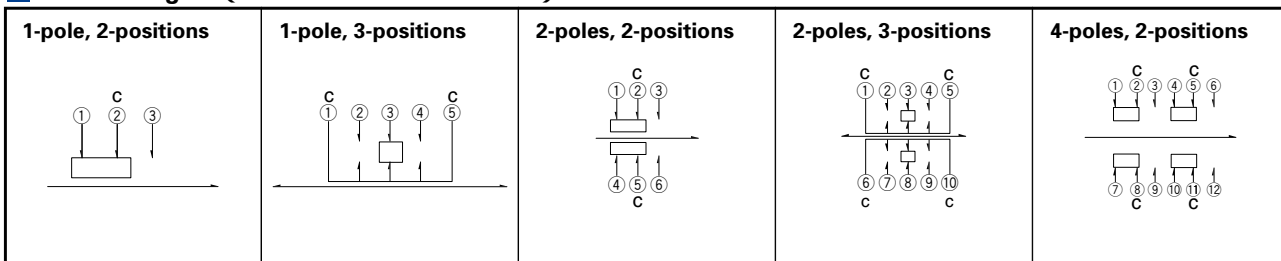

## Actuator Configuration

Unit:mm

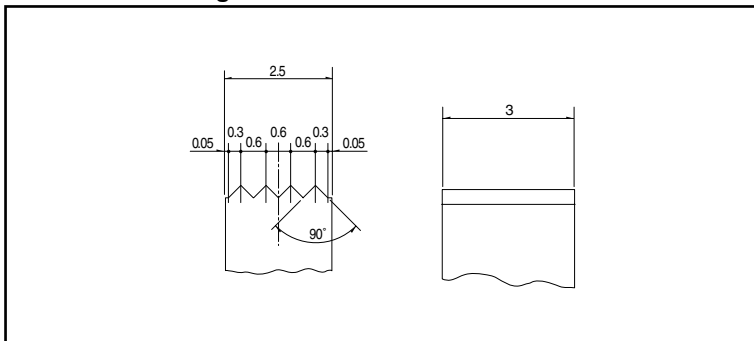





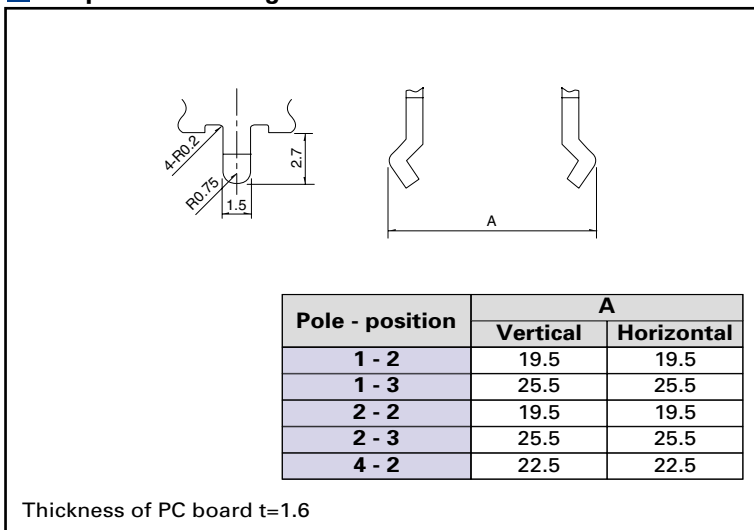





## Shape of Frame Leg

Unit:mm

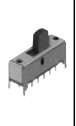
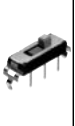

# List of Varieties

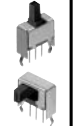
Series		SSAG	SSAH	SSAD	SSSS8	SSSS7	SSSS2	SSSS9	SSSF	SSSU	SSSB	SSST	SSAA	SSAC	SSAB		
Photo																	
Outline specifications	Travel (mm)	1.5			1.5 2		2		3		4		2	1.5	1.9 2		
	Actuator direction	Horizontal			Vertical Horizontal	Horizontal	Vertical Horizontal			Vertical		Horizontal		Vertical Horizontal			
	Number of poles	1			1 2		1 2 4		2 4	1	1 2	2	1				
Dimensions (mm)	W	9.05	9.5	6.7	11.2	8.8	13	14	16.5	24.5	29	13	12.4	9.5	9		
	D	3		3.2	2.6	3	3.5	4.7	7		9	4.3	6	5.5	4.2		
	H	1.15	0.9	0.7	1.4	2		5	8.5		12	3.5	5	5.2	8.5		
Operating temperature range		-10 to +60			-40 to +85		-10 to +60										
Rating (max. )( min. ) (Resistive load)		10mA 5V DC	1mA 5V DC		0.3A 4V DC		0.3A 6V DC	0.1A 12V DC	0.1A 30V DC		0.3A 30V DC	0.1A 12V DC	0.1A 30V DC	1mA 5V DC	0.1A 12V DC		
		50μA 3V DC															
Electrical performance	Initial contact resistance	200m max.		100m max.	70m max.			30m max.	25m max.		20m max.	70m max.	25m max.	100m max.	30m max.		
	Insulation resistance	100M min. 100V DC				100M min. 500V DC										100M min. 100V DC	100M min. 500V DC
	Voltage proof	100V AC for 1minute				500V AC for 1minute								100V AC for 1minute		500V AC for 1minute	
Mechanical performance	Robustness of terminal	3N for 1minute					5N for 1minute			3N for 1minute	5N for 1minute						
	Robustness of actuator	Operating direction		10N	5N	10N	20N	30N		50N	20N	10N	10N	5N	30N		
		Pulling direction				10N Static force			10N	30N Static force						10N	
Durability	Operating life without load	10,000cycles	10,000cycles	10,000cycles 100m max. 2		10,000cycles 60m max.	10,000cycles 45m max.		10,000cycles 40m max.	10,000cycles 100m max.	10,000cycles 45m max.	10,000cycles 200m max.	1,000cycles 60m max.				
	Operating life without load Load as rating	500m max.	300m max.	10,000cycles 200m max.	10,000cycles 130m max. 2		10,000cycles 80m max.	10,000cycles 65m max.		5,000cycles 60m max.	10,000cycles 130m max.	10,000cycles 65m max.	10,000cycles 80m max.				
Environmental performance	Cold	-40 ± 2 for 96h		-20 ± 2 for 96h													
	Dry heat	85 ± 2 for 96h															
	Damp heat	40 ± 2 , 90 to 95%RH for 96h															
Soldering	Manual soldering	350 ± 5 3s max.		300 ± 5 5s max.		260 ± 5 3s max.	350 ± 10 4s max.	300 ± 10 5s max.	350 ± 10 5s max.	350 ± 10 3 ± 1s		350 ± 10 3s max.	300 ± 10 3 ± 1s	300 ± 10 2s	350 ± 10 3 ± 1s		
	Dip soldering						260 ± 5 3 ± 1s	260 ± 5 5 ± 1s		260 ± 5 10 ± 1s		260 ± 5 5 ± 1s	260 ± 10 10 ± 1s	260 ± 10 5 ± 1s	260 ± 5 10 ± 1s		
	Reflow soldering	Please see P.154															
Poles-positions	1-2	—	—								—			—			
	1-3			—											—		
	1-4	—				—					—						
	2-2	—				—										—	
	2-3	—				—										—	
	2-4	—				—					—						
	4-2	—				—							—				
Page	112	115	117	119	123	126	130	135	139	143	146	147	150	152			

- Detector
- Push
- Slide**
- Rotary
- Encoders
- Power
- Dual-in-line Package Type
- TACT Switch™
- Custom-Products

- Small size General Use type
- Big size General Use type
- Other Use type

Slide Switches Soldering Conditions ..... 154  
 Slide Switches Cautions ..... 155

**Note**

The operating temperature range for automotive applications can be raised upon request. Please contact us for requirements of this kind.



## Стандарт Электрон Связь

Мы молодая и активно развивающаяся компания в области поставок электронных компонентов. Мы поставляем электронные компоненты отечественного и импортного производства напрямую от производителей и с крупнейших складов мира.

Благодаря сотрудничеству с мировыми поставщиками мы осуществляем комплексные и плановые поставки широчайшего спектра электронных компонентов.

Собственная эффективная логистика и склад в обеспечивает надежную поставку продукции в точно указанные сроки по всей России.

Мы осуществляем техническую поддержку нашим клиентам и предпродажную проверку качества продукции. На все поставляемые продукты мы предоставляем гарантию .

Осуществляем поставки продукции под контролем ВП МО РФ на предприятия военно-промышленного комплекса России , а также работаем в рамках 275 ФЗ с открытием отдельных счетов в уполномоченном банке. Система менеджмента качества компании соответствует требованиям ГОСТ ISO 9001.

Минимальные сроки поставки, гибкие цены, неограниченный ассортимент и индивидуальный подход к клиентам являются основой для выстраивания долгосрочного и эффективного сотрудничества с предприятиями радиоэлектронной промышленности, предприятиями ВПК и научно-исследовательскими институтами России.

С нами вы становитесь еще успешнее!

### Наши контакты:

**Телефон:** +7 812 627 14 35

**Электронная почта:** [sales@st-electron.ru](mailto:sales@st-electron.ru)

**Адрес:** 198099, Санкт-Петербург,  
Промышленная ул, дом № 19, литера Н,  
помещение 100-Н Офис 331