



Drop-in Networking Professional Development Kit **GETTING STARTED GUIDE**

ZB Series



©2009 Digi International Inc. All Rights Reserved.

Digi, Digi International, the Digi logo, ConnectPort, Connectware, XBee, and XBee-PRO are trademarks or registered trademarks of Digi International, Inc. in the United States and other countries worldwide.

All other trademarks are the property of their respective owners.

Information in this document is subject to change without notice and does not represent a commitment on the part of Digi International.

Digi provides this document “as is,” without warranty of any kind, either expressed or implied, including, but not limited to, the implied warranties of fitness or merchantability for a particular purpose. Digi may make improvements and/or changes in this manual or in the product(s) and/or the program(s) described in this manual at any time.

This product could include technical inaccuracies or typographical errors. Changes are periodically made to the information herein; these changes may be incorporated in new editions of the publication.

OBJECTIVES

Upon completing this kit, you will be able to:

- Set up a Drop-in Network
- Perform a range test of the XBee® radios in the kit
- Discover wireless devices in an XBee network
- Run applications written in Python® on a ConnectPort™ X gateway and PC
- Send and receive data from wireless devices over an Ethernet/IP network
- Use resources to develop embedded applications
- Use resources to manage Drop-in Networks



As an integral part of the Drop-in Networking strategy, the Python custom development environment is incorporated by Digi into each ConnectPort X gateway. Unlike many development proprietary embedded development platforms, Digi's integration of the universal Python scripting language provides customers a truly open standard for complete control over the connections to devices, manipulation of data, and event-based actions. For more information about Digi's Python custom development platform, visit our Python portal today at:

<http://www.digi.com/technology/drop-in-networking/pdr.jsp>

QUESTIONS?

For technical assistance with your Drop-in Network, call:

1-800-903-8430 (US Only)

Digi contact numbers outside US:

Country	Toll Free Number
Argentina	00-800-3444-3666
Australia	0011-800-3444-3666
Brazil	0021-800-3444-3666
China North	00-800-3444-3666
China South	00-800-3444-3666
France	00-800-3444-3666
Germany	00-800-3444-3666
Hong Kong	001-800-3444-3666
India	000-800-100-3383
Israel	00-800-3444-3666
Italy	00-800-3444-3666
Japan	For calls from KDD fixed land-line phones: 010-800-3444-3666 From KDD public and mobile phones: 001-010-800-3444-3666 For non-KDD phones: 122-001-010-800-3444-3666
Korea	002-800-3444-3666
Mexico	001-800-903-8430
Netherlands	00-800-3444-3666
New Zealand	00-800-3444-3666
South Thailand	001-800-3444-3666
Spain	00-800-3444-3666
United Kingdom	00-800-3444-3666

Contents

OBJECTIVES	3
QUESTIONS?	4
Connect the gateway and USB interface board	7
Connect and power on gateway	8
Connect and power on USB interface board	12
LEDs and buttons for interface boards	14
Perform a range test	17
What is a range test?.....	17
Equipment used in range test.....	17
Install and start X-CTU software.....	17
X-CTU user interface.....	18
Discover nodes.....	19
Run range test	21
What does this test show you?	22
Use gateway to discover nodes	23
Connect the gateway to Ethernet and discover it	23
Connect and power on RS-232 interface board	25
Plug in the XBee Wall Router	27
View nodes	30
Run gateway and PC demo applications	35
Install Drop-in Networking software/documentation on PC	35
Upload the gateway demo application to gateway	37
Run the gateway demo application	38
Run the PC companion application	40
Manage Drop-in Networks	45
Congratulations!	45
Use Connectware Manager.....	45
Contact Digi.....	46

Connect the gateway and USB interface board

The Drop-in Networking Professional Development Kit contains several boxes:

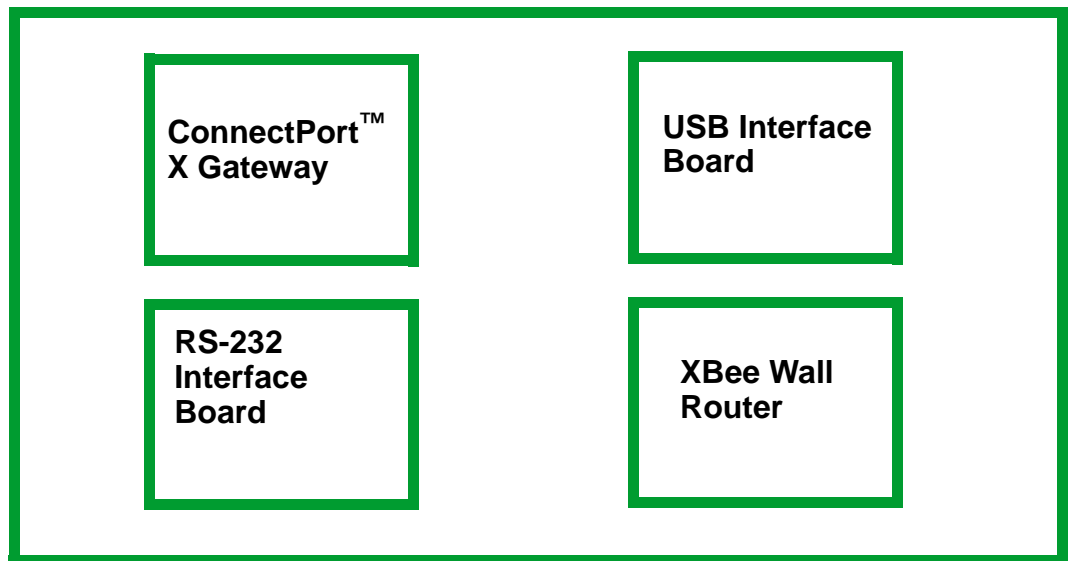

To run the kit, you will also need:



A PC, configured to obtain an IP address automatically

Hardware & Software Setup CD



Digi ConnectPort X gateways are available in multiple configurations: XBee-to-Ethernet, XBee-to-WiFi, and XBee-to-Cellular. The latter two configurations enable end-to-end wireless device connectivity.

Connect the gateway and USB interface board

Connect and power on gateway

1. Open and unpack the box labeled **ConnectPort X4 Gateway**.
2. Connect the power supply to the gateway and turn the connector clockwise to tighten. Connect the power supply to an outlet.

Note (International version only): Connect the power supply to a power cord (not included), and the power cord to an outlet.

3. Connect the antenna to the barrel connector on the gateway. Turn the connector clockwise to tighten.

Note: Do **not** connect the cross-over Ethernet cable at this time.

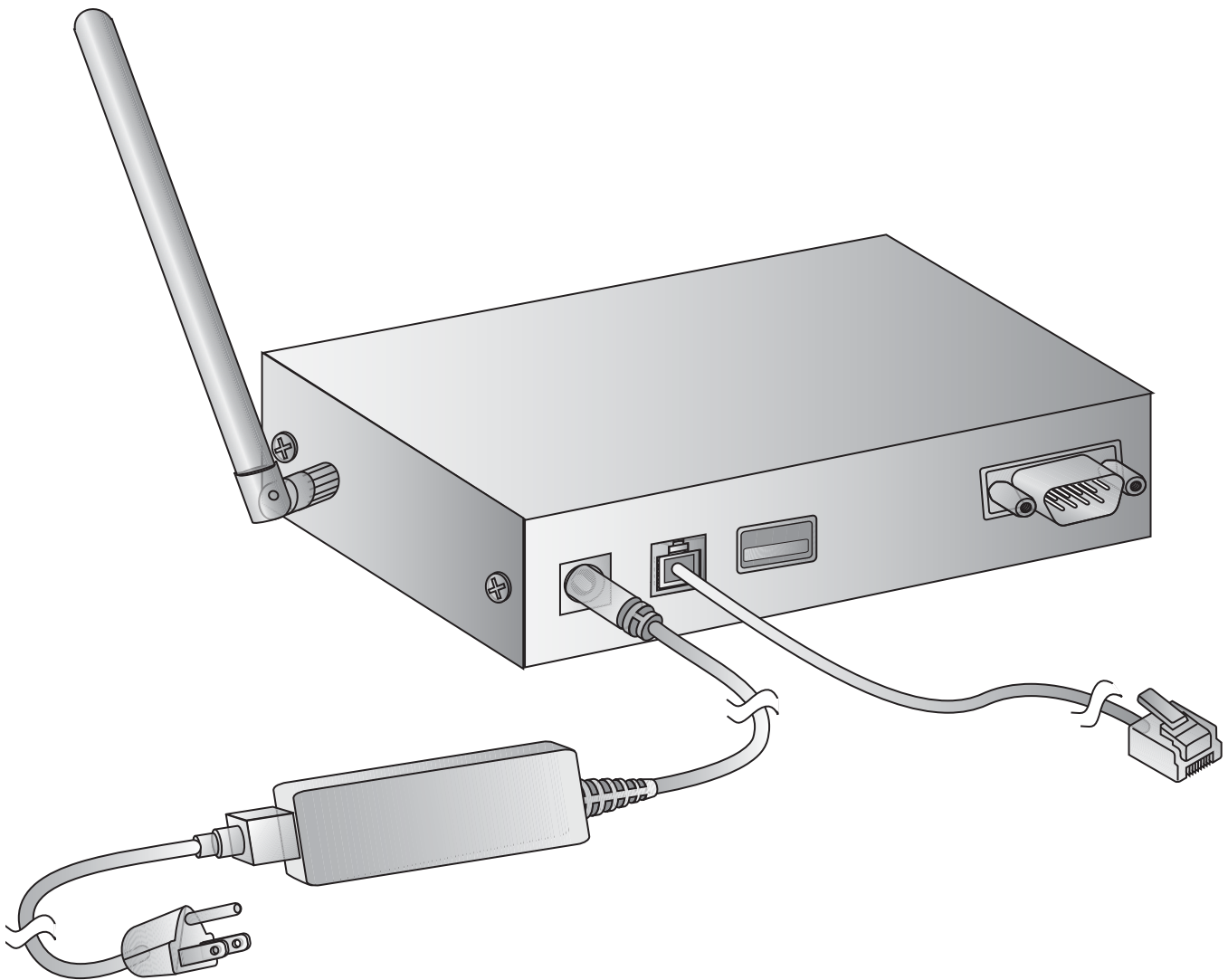

LEDs and buttons

The gateway has several LEDs that indicate activity, and a Reset button.

Top panel

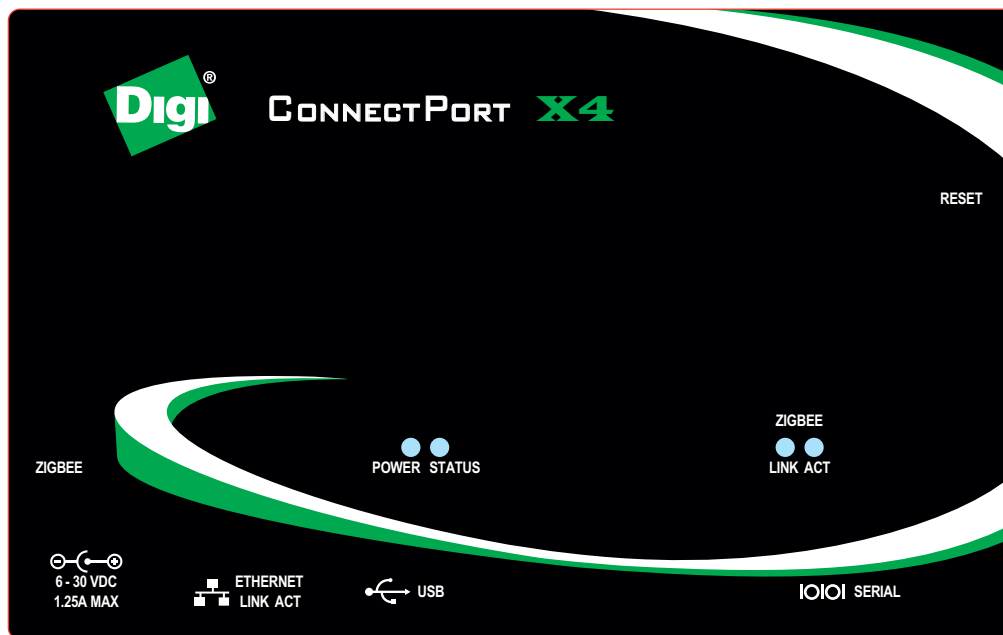

Back panel

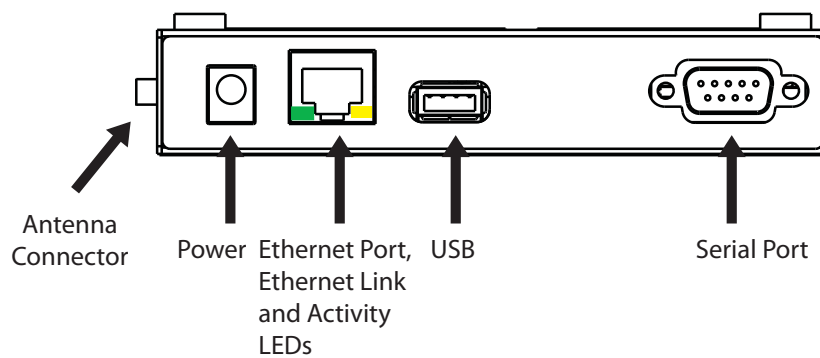

Connect the gateway and USB interface board

LED/button	Color and Light Pattern	Description
Power LED	Blue	Power is applied.
	Not illuminated	No power.
Status LED	Yellow	Blinks during product initialization and factory reset, using the light patterns below. During normal device operation after initialization and factory reset, this LED is off and should never blink. If it blinks constantly, contact Digi Technical Support.
	1-1-1 blinking yellow	Firmware is initializing.
	1-5-1 blinking yellow	Device configuration has been restored to its factory defaults.
	Other blinking yellow	Contact Digi Technical Support.
ZigBee/XBee Link LED	Green	Indicates that the XBee RF module in the gateway has associated with an XBee network: For more information on this indicator, see the description of the D5 (DIO5 Configuration) parameter in the product manual for the XBee module.
	Solid green	XBee module in gateway is associated (or coordinator is started).
	Fast blinking (20 Hz) green	An Ident (identify) button has been pressed on a remote node.
	Slow (1 Hz) blinking green	XBee module in gateway is not associated.
	Off	XBee module in gateway is disabled or not recognized.
ZigBee/XBee Activity LED	Yellow	On for 25 ms when data is sent or received from the XBee module in the gateway.
Ethernet Link LED	Solid yellow	Ethernet link is up.
Ethernet Activity LED	Blinking green	Ethernet traffic is on the link.
Reset button	N/A	Single press: Performs equivalent of a power-cycle. Press and hold: Resets device configuration settings to factory defaults (factory reset).

Connect the gateway and USB interface board

Now, your network looks like this:

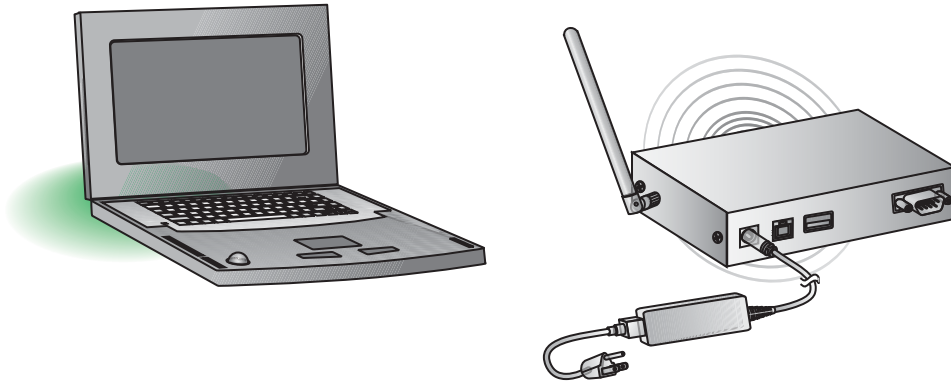

Gateway connected to power only

Connect the gateway and USB interface board

Connect and power on USB interface board

1. Open and unpack the box labeled **XBee USB Interface Board**.
2. Connect the XBee-PRO module to the connectors on the interface board. Orient the board and connector pins as shown in the diagram.
3. Connect the antenna to the RPSMA antenna connector on the XBee-PRO module. Turn the connector clockwise to tighten.
4. Connect the USB cable to the USB port on the interface board and PC.

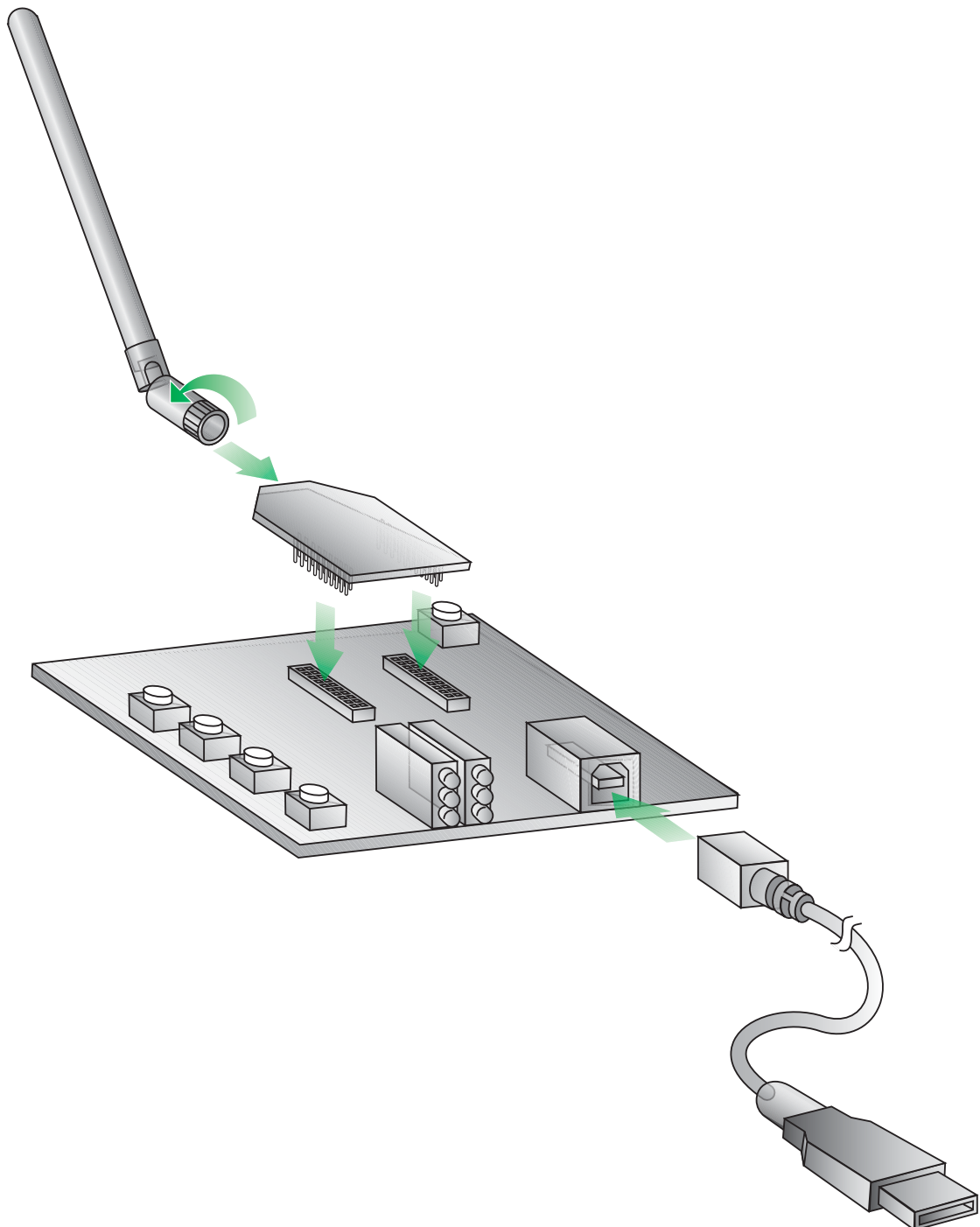

Install USB driver

The USB interface board is a "plug-and-play" device that should be detected by the PC automatically. After the USB interface board is detected, a wizard for installing USB drivers is launched. To interface between the modem and a PC, two drivers must be installed: a USB driver, and a virtual COM port driver that makes the USB port look and perform like a physical COM port. The USB drivers are included on the Hardware & Software Setup CD.

1. Verify that the Hardware & Software Setup CD is inserted into the drive.
2. Connect the XBee module to a PC using a USB cable. The **Found New Hardware Wizard** dialog box is displayed.
3. Select **Install from a specific list or location (Advanced)**; then click **Next**.
4. Select **Search for the best driver in these locations** and **Search removable media (CD-ROM...)**. Then click **Next**.
A **Hardware Installation Windows Logo Testing** alert box is displayed.
5. Click **Continue Anyway**.
6. Click **Finish**.
7. You are prompted to install another driver, the virtual COM port driver. Repeat steps 3 through 6 to install this driver.

Connect the gateway and USB interface board

LEDs and buttons for interface boards

The XBee interface boards in the kit have several LEDs that indicate network activity and signal strength, plus several buttons.

USB interface board

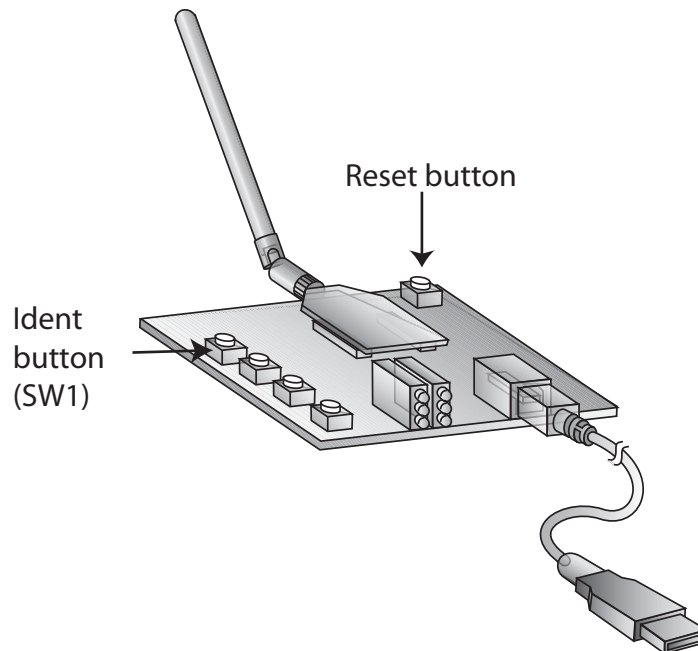
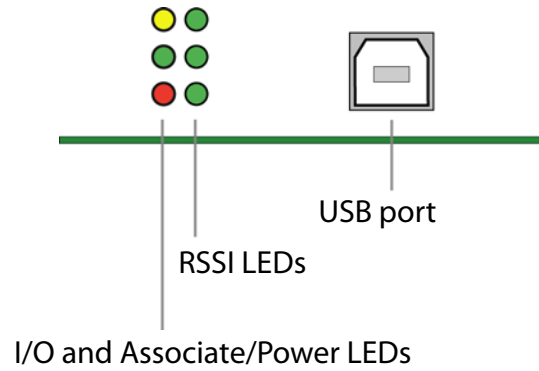

LED and button descriptions/behaviors

LED/button	Description																
I/O and Associate/Power LEDs	Indicate RF module activity: <ul style="list-style-type: none"> • Yellow (top LED): Serial Data Out (to host) • Green (middle): Serial Data In (from host) • Red (bottom): Associate/Power Indicator. Indicates both power to the interface board and the network association status for the XBee module in the interface board. <p>Solid red: XBee module powered and not associated to a network.</p> <p>Blinking red: XBee module has associated to a network.</p> For more information on this indicator, see the description of the D5 (DIO5 Configuration) parameter in the product manual for the XBee module. 																
RSSI (signal strength) LEDs	Indicate the amount of fade margin present in an active wireless link. The fade margin is the difference between the incoming signal strength and the module's receiver sensitivity. <ul style="list-style-type: none"> • 3 LEDs on: Very Strong Signal (> 30 dB fade margin) • 2 LEDs on: Strong Signal (> 20 dB fade margin) • 1 LED on: Moderate Signal (> 10 dB fade margin) • 0 LED on: Weak Signal (< 10 dB fade margin) 																
Reset button	Performs equivalent of a power-cycle.																
Ident button (SW1 on the interface board)	Performs actions for commissioning the XBee module in a network. Consecutive button presses must occur within 800ms second of each other to perform desired actions. <table border="1" data-bbox="386 961 1469 1906"> <thead> <tr> <th data-bbox="386 961 516 1056">Button press</th> <th data-bbox="521 961 716 1056">Network association</th> <th data-bbox="721 961 1469 1056">Action</th> </tr> </thead> <tbody> <tr> <td data-bbox="386 1062 516 1304" rowspan="2">Single</td> <td data-bbox="521 1062 716 1304">Associated</td> <td data-bbox="721 1062 1469 1304"> <ul style="list-style-type: none"> • If unit is asleep, wakes unit for 30 seconds. • Sends a Node Identification broadcast transmission. All devices receiving this transmission blink their Associate LED rapidly for 1 second. All API devices that receive this transmission send a Node Identification frame out their UART (universal asynchronous receiver/transmitter) (API ID 0x95). </td> </tr> <tr> <td data-bbox="521 1310 716 1667">Unassociated</td> <td data-bbox="721 1310 1469 1667"> <ul style="list-style-type: none"> • If unit is asleep, wakes unit for 30 seconds. • Blinks a numeric error code on the Assc LED, indicating the cause of join failure. <p>1 blink: Scan found no PANs.</p> <p>2 blinks: Scan found no valid PANs based on current SC (Scan Channel) and ID (PAN ID) settings.</p> <p>3 blinks: Valid Coordinator or Routers found, but they are not allowing joining (NJ expired).</p> <p>7 blinks: Node Joining attempt failed.</p> <p>10 blinks: Coordinator Start attempt failed.</p> </td> </tr> <tr> <td data-bbox="386 1673 516 1820">Two</td> <td data-bbox="521 1673 716 1820">Associated</td> <td data-bbox="721 1673 1469 1820"> Temporarily enables joining on the unit and the entire network for 1 minute (if the XBee module's NJ command setting is less than 255). If joining is permanently enabled on a module (NJ = 255), joining remains permanently enabled, and this button press has no effect. </td> </tr> <tr> <td data-bbox="386 1827 516 1906">Four</td> <td data-bbox="521 1827 716 1906">Associated/Unassociated</td> <td data-bbox="721 1827 1469 1906"> Unit leaves PAN, if associated, and issues a factory reset to restore default parameters. Default PAN ID is 0. </td> </tr> </tbody> </table>			Button press	Network association	Action	Single	Associated	<ul style="list-style-type: none"> • If unit is asleep, wakes unit for 30 seconds. • Sends a Node Identification broadcast transmission. All devices receiving this transmission blink their Associate LED rapidly for 1 second. All API devices that receive this transmission send a Node Identification frame out their UART (universal asynchronous receiver/transmitter) (API ID 0x95). 	Unassociated	<ul style="list-style-type: none"> • If unit is asleep, wakes unit for 30 seconds. • Blinks a numeric error code on the Assc LED, indicating the cause of join failure. <p>1 blink: Scan found no PANs.</p> <p>2 blinks: Scan found no valid PANs based on current SC (Scan Channel) and ID (PAN ID) settings.</p> <p>3 blinks: Valid Coordinator or Routers found, but they are not allowing joining (NJ expired).</p> <p>7 blinks: Node Joining attempt failed.</p> <p>10 blinks: Coordinator Start attempt failed.</p> 	Two	Associated	Temporarily enables joining on the unit and the entire network for 1 minute (if the XBee module's NJ command setting is less than 255). If joining is permanently enabled on a module (NJ = 255), joining remains permanently enabled, and this button press has no effect.	Four	Associated/Unassociated	Unit leaves PAN, if associated, and issues a factory reset to restore default parameters. Default PAN ID is 0 .
Button press	Network association	Action															
Single	Associated	<ul style="list-style-type: none"> • If unit is asleep, wakes unit for 30 seconds. • Sends a Node Identification broadcast transmission. All devices receiving this transmission blink their Associate LED rapidly for 1 second. All API devices that receive this transmission send a Node Identification frame out their UART (universal asynchronous receiver/transmitter) (API ID 0x95). 															
	Unassociated	<ul style="list-style-type: none"> • If unit is asleep, wakes unit for 30 seconds. • Blinks a numeric error code on the Assc LED, indicating the cause of join failure. <p>1 blink: Scan found no PANs.</p> <p>2 blinks: Scan found no valid PANs based on current SC (Scan Channel) and ID (PAN ID) settings.</p> <p>3 blinks: Valid Coordinator or Routers found, but they are not allowing joining (NJ expired).</p> <p>7 blinks: Node Joining attempt failed.</p> <p>10 blinks: Coordinator Start attempt failed.</p> 															
Two	Associated	Temporarily enables joining on the unit and the entire network for 1 minute (if the XBee module's NJ command setting is less than 255). If joining is permanently enabled on a module (NJ = 255), joining remains permanently enabled, and this button press has no effect.															
Four	Associated/Unassociated	Unit leaves PAN, if associated, and issues a factory reset to restore default parameters. Default PAN ID is 0 .															

Connect the gateway and USB interface board

Perform a range test

What is a range test?

A range test demonstrates the real-world RF range of the XBee embedded modules in the Drop-in Networking Professional Development Kit.

This range information is useful when planning for and deploying an actual network.

Equipment used in range test

The range test uses this equipment:

- PC
- USB interface board, connected to the PC via the USB cable
- ConnectPort X gateway

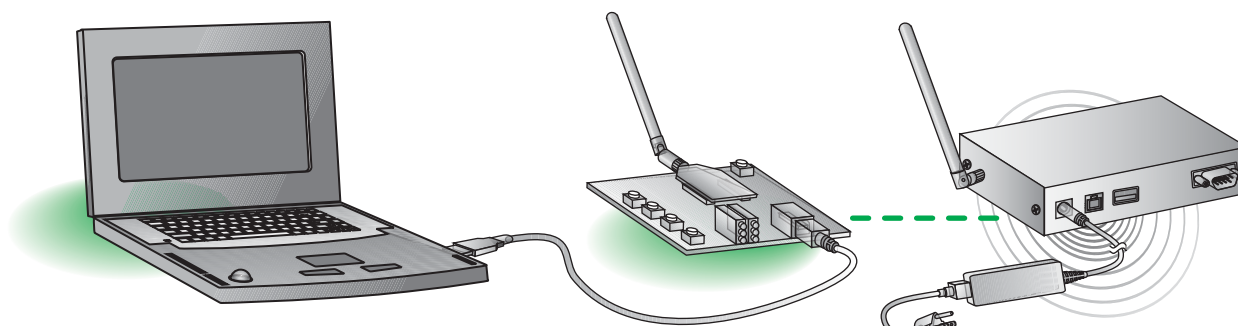

Install and start X-CTU software

X-CTU is a software tool for configuring XBee modules that is included on the Hardware & Software Setup CD. X-CTU is used to run the range test.

To install X-CTU:

1. Insert the **Hardware & Software Setup CD** in the PC's CD-ROM/DVD drive. The CD should auto-launch when placed in the CD-ROM drive. If not, browse to the CD using Explorer and double click **start.exe**.
2. On the Home page, click **Modules, Sensors & Adapters Documentation/Software**.
3. Click **XBee Modules > XBee XB Module**.
4. Click **Install X-CTU (EXE)**.
5. When prompted to check the Web for updates, ensure your PC is connected to the Internet and click **Yes**.
6. When installation completes, to start X-CTU, select **Start > Programs > Digi > X-CTU**.

Perform a range test

The X-CTU software interface is displayed.

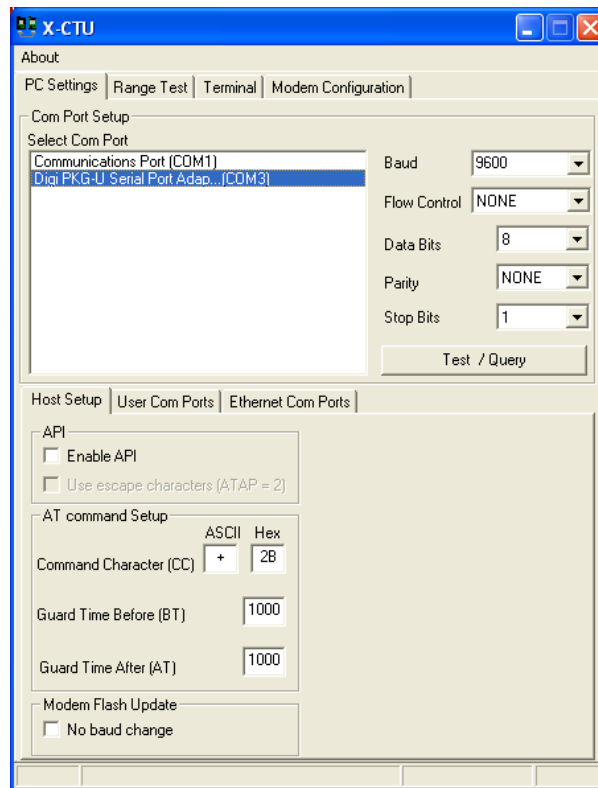

X-CTU user interface

The X-CTU interface has several tabs:

- **PC Settings:** Sets up PC serial COM ports to interface with the XBee module.
- **Range Test:** Tests the range of wireless links under varying conditions.
- **Terminal:** Reads and sets communications parameters on the XBee module and monitors data communications.
- **Modem Configuration:** Reads and sets configuration parameters on the XBee module.

For more information on X-CTU functions, features, and controls, see the X-CTU Configuration Test Utility Software manual, available for downloading at www.digi.com.

Discover nodes

This kit demonstrates discovering nodes from a variety of interfaces. In this first instance, node discovery is done through X-CTU.

This procedure involves entering command mode and sending AT commands. If you are unfamiliar with either concept, see the Command Mode section of the XBee module's product manual.

1. In the X-CTU interface, on the **PC Settings** tab, select the COM port to which the USB interface board is attached; this is the COM port created during USB driver installation. Select **DIGI-PKG-U (Serial Port Adap...)**

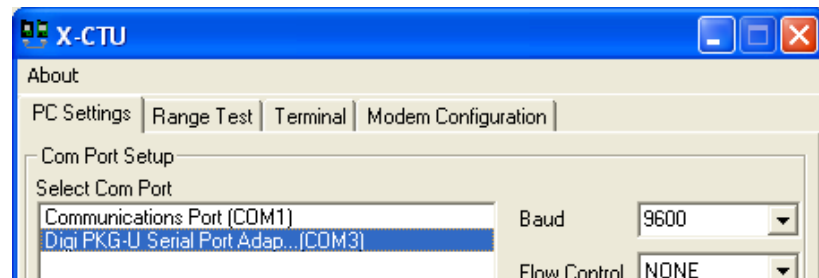

2. On the **Terminal** tab, enter command mode. This mode eliminates over-the-air communications for the XBee module, and allows internal communication with the XBee module parameters. There is a one-second "guard time" before and after entering command mode, and a ten-second timeout.

To enter command mode, enter **+++** with no carriage return.

When command mode is entered, an **OK** message is displayed.

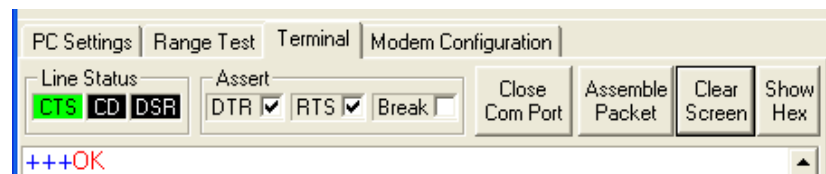

3. Enter the **atnd** (Node Discover) command followed by a carriage return. This command discovers and reports all modules on its current operating channel and PAN ID (ID parameter). All powered nodes that have joined the network respond to this command with their device information.

One node should be returned: the ConnectPort X gateway. The gateway is identified by the **extended address** of its integrated XBee module. Every XBee device will have a unique extended address. In X-CTU, this address is split over two lines, as shown:

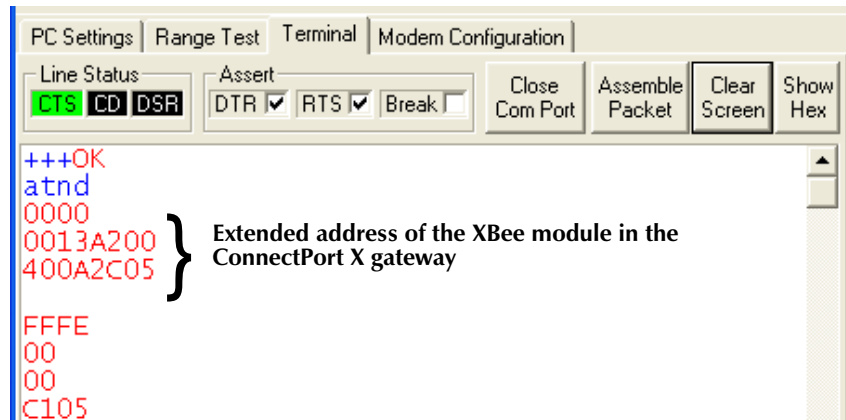

Note: If you encounter problems in this step, there is a way to force the XBee module on the interface board to leave any XBee network it may have joined and attempt to join an XBee network. Press the Ident/SW1 button on the USB interface board four times to attempt to associate to the gateway. Association is indicated by a blinking red LED. See "LEDs and buttons" on page 9.

Run range test

1. On the **Terminal** tab, re-enter command mode by typing **+++** with no carriage return.
2. Set loopback mode for the XBee module on the gateway. Enter this command:

atci12

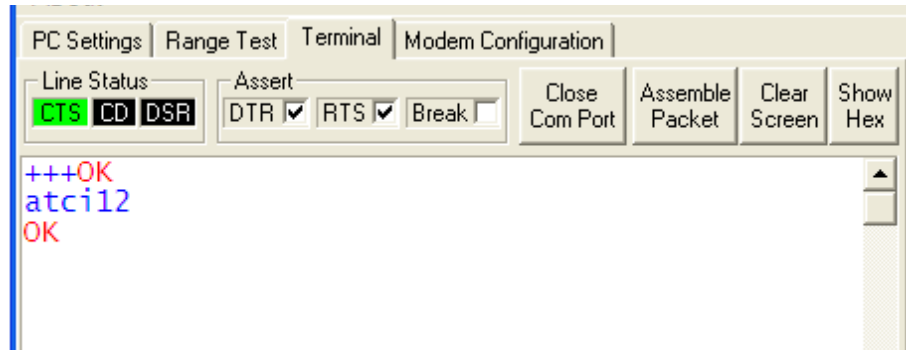

The **atci12** command (Destination Cluster ID=12, Loopback) sets the cluster ID on packets transmitted from the XBee module. Packets sent with this cluster ID value are sent back to the originator when received by the recipient (the XBee module in the gateway).

3. Click the **Range Test** tab.
4. Enable the checkbox in the RSSI part of the display to display the received signal strength indicator.

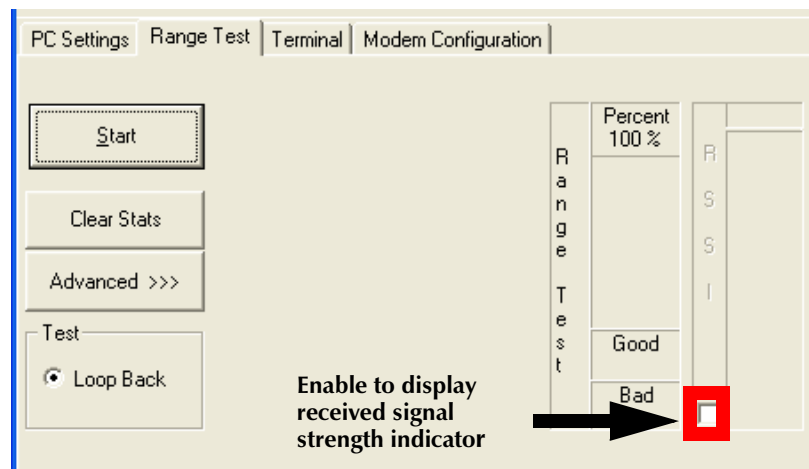

5. Click the **Start** button to start the range test.

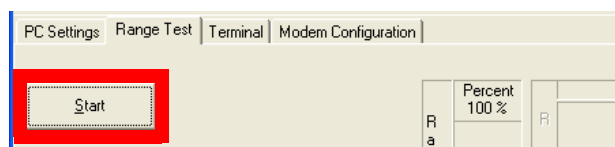

The range test runs indefinitely until you click **Stop**.

As the test runs, the **0123...LMNO** data is the default data packet that is transmitted and received between the radios. The **Percent** field indicates true link quality by showing the percentage of successful packet transmissions. If the **RSSI** checkbox is enabled, the signal strength of packets received by the XBee module on the USB interface board is displayed.

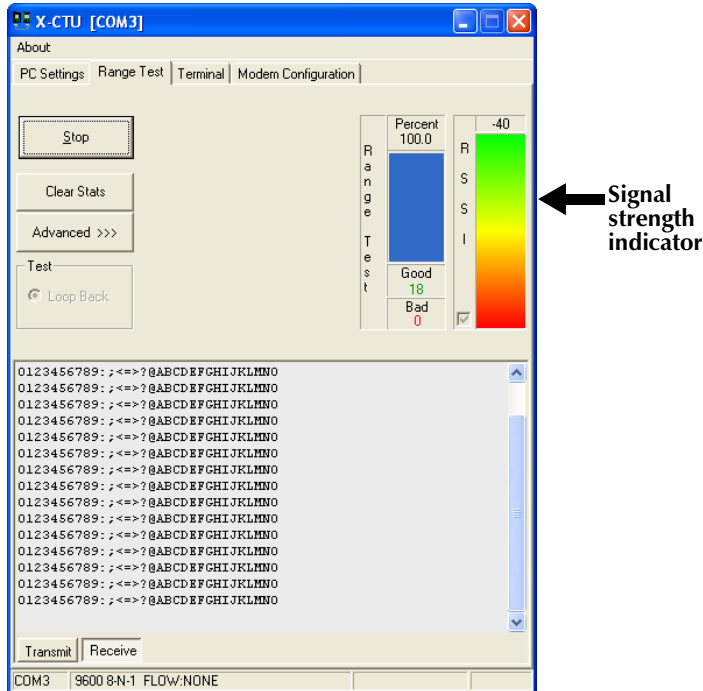

6. Test the range of the wireless link between the XBee modules on the interface board and gateway:
 - Move the PC and USB interface board away from the gateway, or remove the antenna from the USB interface board's XBee module.
 - Click **Start** again.
 - Observe how the signal strength indicator changes.
7. Click **Stop** to end the range test.

What does this test show you?

The range test gives a sense of the range of the kit's XBee modules. When deploying an actual network, multiple range tests are recommended to test for varying conditions in your application. If a range test indicates there is not enough range in an area where network devices must reside, you can install XBee Wall Routers to extend the range. The XBee Wall Router is designed primarily to "patch" areas within an XBee network where signal erosion or loss occurs due to distance limitations or interference.

Use gateway to discover nodes

In this task, you will connect the rest of the kit's devices and use the gateway's web interface to find and view all nodes in the Drop-in Network.

Connect the gateway to Ethernet and discover it

Up to this point, you have been working from the point of view of the embedded XBee modules in an XBee network. Now, you will view and manage the network devices from the Ethernet network.

1. Connect the crossover Ethernet cable to the **Ethernet** port of the gateway, and the other end to the Ethernet port of the PC.

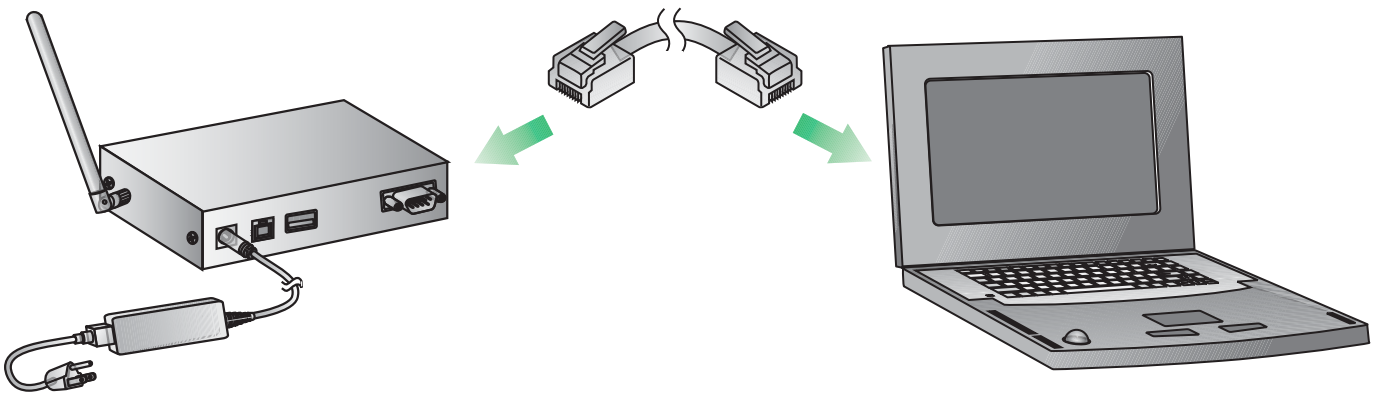

2. To find the gateway in the Ethernet network, run the Digi Device Discovery application, included on the Hardware & Software Setup CD. Insert the CD into the PC's CD/DVD drive.
3. Click **Gateway, Host PC & Enterprise Documentation/Software**.
4. Click **Gateways**.
5. Click **Configuration**.
6. Click **Digi Device Discovery (EXE)**.

Use gateway to discover nodes

The Digi Device Discovery application is opened. It displays all Digi devices on the Ethernet network.

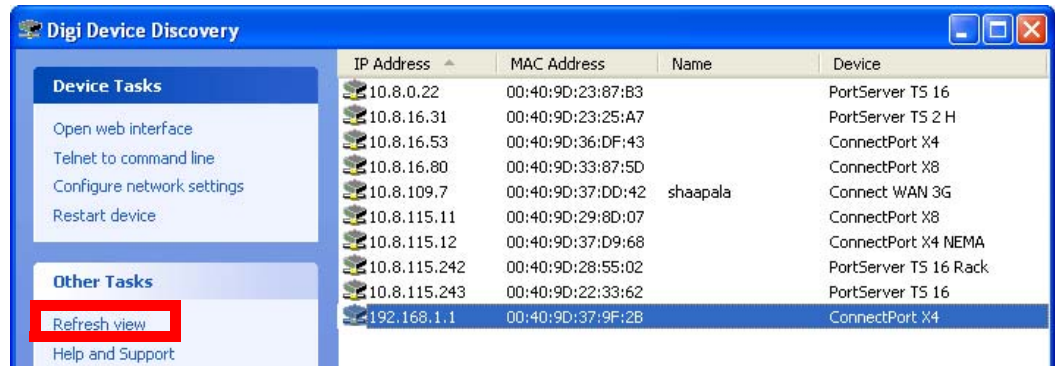

Note: If the gateway does not display, click **Refresh View**. If it still does not display, make sure any Windows firewalls are disabled. If the gateway is displayed with a label showing it as misconfigured, under **Device Tasks**, select **Configure network settings** and select **Obtain Network Settings Automatically**. Click **Save**. Answer **OK** when prompted for a restart.

7. Locate the ConnectPort X gateway in the device list by its **MAC address**. This address is printed on a label on the bottom of the gateway. Note that this MAC address is for the Digi Connect ME Ethernet module in the gateway, not the XBee module.
8. Double-click the ConnectPort X gateway. The web interface of the gateway is opened.

ConnectPort X4 Configuration and Management

Home

Configuration

- Network
- XBee Network
- Serial Ports
- Camera
- Alarms
- System
- Remote Management
- Security
- Position

Applications

- Python
- RealPort
- Industrial Automation

Management

- Serial Ports
- Connections
- Event Logging
- Network Services

Administration

- File Management
- X.509 Certificate/Key Management
- Backup/Restore
- Update Firmware
- Factory Default Settings
- System Information
- Reboot

Logout

Home

Getting Started

Tutorial Not sure what to do next? This Tutorial can help.

System Summary

Model:	ConnectPort X4
Ethernet MAC Address:	00:40:9D:37:9F:2B
Ethernet IP Address:	192.168.1.1
Description:	None
Contact:	None
Location:	None
Device ID:	00000000-00000000-00409DFF-FF379F2B

Connect and power on RS-232 interface board

Now, add the RS-232 interface board to the network.

1. Open and unpack the box labeled **RS-232 Interface Board**.
2. Connect the XBee module to the connectors on the interface board. Orient the board and connector pins as shown in the diagram.
3. Connect the male null modem adapter to the serial port of the interface board.
4. Connect the serial loopback plug to the male null modem adapter and tighten connections.
5. Connect the power supply to the interface board.

International version only: Select the plug type that is appropriate for your country from the plugs included in the **RS-232 Interface Board** box. Attach the plug to the power supply, and plug the power supply into an outlet.

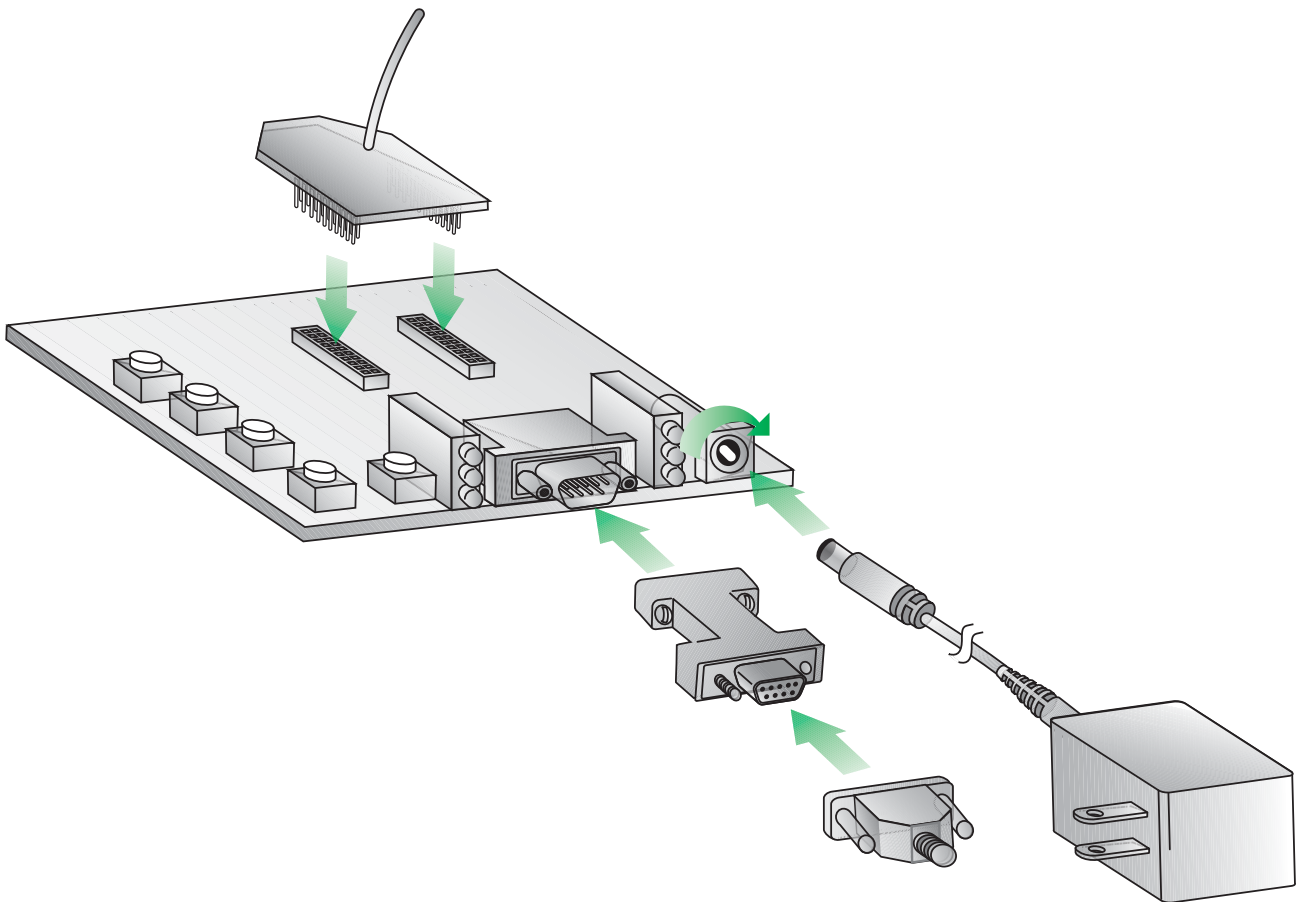

LEDs and buttons

The LEDs and buttons on the RS-232 interface board are shown below. Their operation and actions are the same as those for the USB interface board; see page 14 for descriptions.

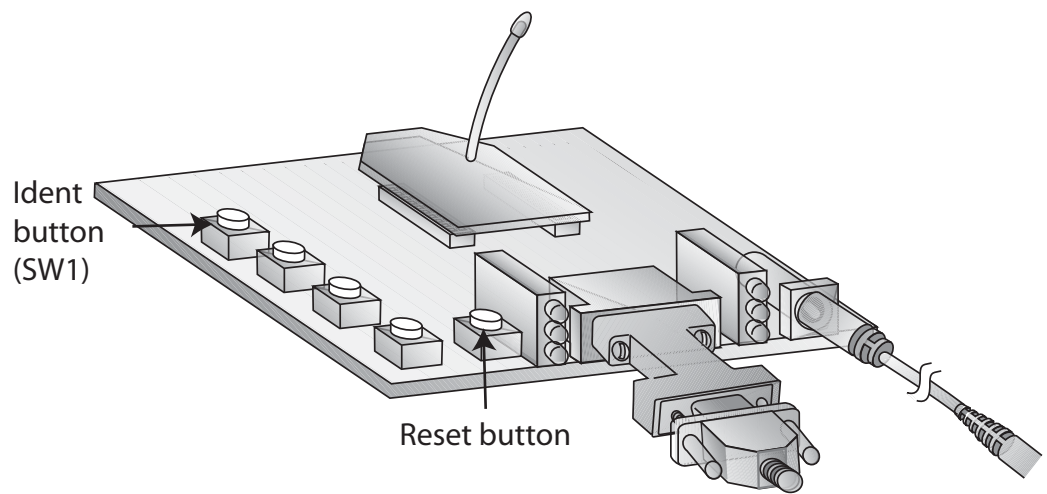
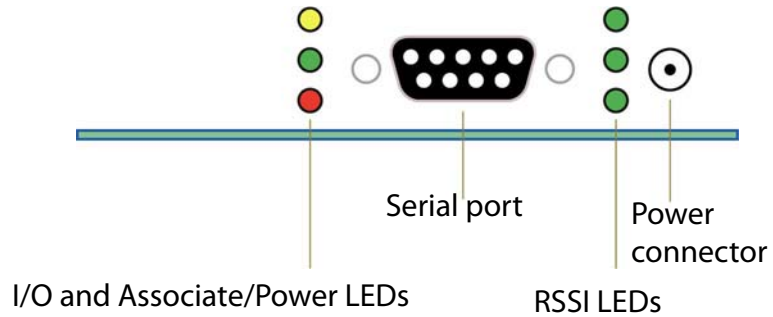

Plug in the XBee Wall Router

1. Plug the XBee Wall Router into a wall socket.

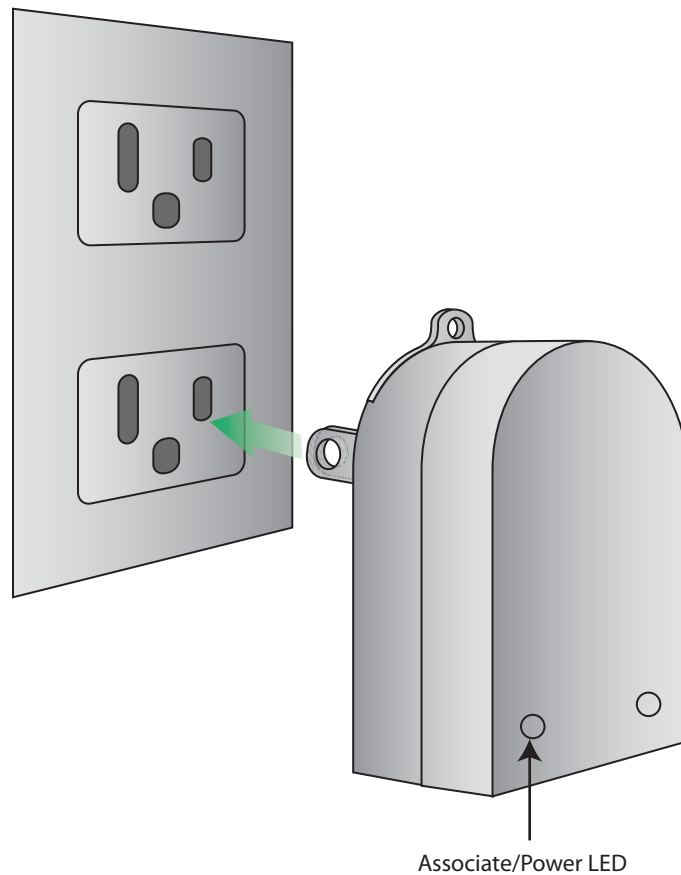

2. Observe the **Assoc** LED (Associate/Power) on the end of the adapter. When it changes from solid green to blinking green, the XBee Wall Router has joined the wireless network.

Use gateway to discover nodes

LEDs, buttons, and integrated sensors

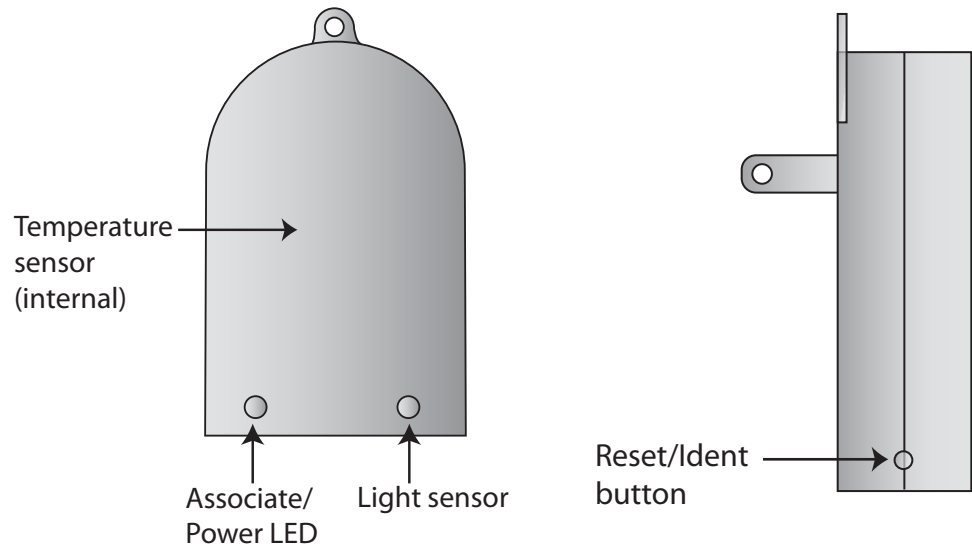

LED/button	Description		
Associate/ Power LED	Indicates power and the XBee Wall Router's ZigBee network association status. <ul style="list-style-type: none"> • Solid green: XBee module is powered and not associated to a ZigBee network. • Blinking green: XBee module is powered and has associated to a ZigBee network. 		
Reset/ Ident button	Performs a reset and multiple functions for commissioning the XBee Wall Router in a ZigBee network. Use a small non-conductive tool with a blunt end to press gently and hold down button. Consecutive button presses must occur within 800 milliseconds of each other to perform the desired action.		
	Button press	Network association	Action
Single	Associated	If XBee Wall Router is asleep, wakes unit for 30 seconds. Sends a Node Identification broadcast transmission. All devices that receive this transmission will blink their Associate LED rapidly for 1 second. All API devices that receive this transmission will send a Node Identification frame out their UART (universal asynchronous receiver/transmitter) (API ID 0x95).	
	Unassociated	If XBee Wall Router is asleep, wakes unit for 30 seconds, then blinks the AI code, a numeric error code, on the Assc LED, indicating the cause of join failure. 1 blink: Scan found no PANs. 2 blinks: Scan found no valid PANs based on current SC (Scan Channel) and ID (PAN ID) settings. 3 blinks: Valid Coordinator or Routers found, but they are not allowing joining (NJ expired). 7 blinks: Node Joining attempt failed. 10 blinks: Coordinator Start attempt failed.	
Two	Associated	Temporarily enables joining on the XBee Wall Router and the entire ZigBee network for 1 minute (if the RF module's NJ command setting is less than 255). If joining is permanently enabled on a module (NJ = 255), joining remains permanently enabled, and this button press has no effect.	
Four	Associated/ Unassociated	XBee Wall Router leaves PAN, if associated, and issues a factory reset to restore default parameters in the XBee module. Default PAN ID is 0 .	
Hold for five seconds	Associated/ Unassociated	Performs a hardware reset.	

Use gateway to discover nodes

View nodes

Next, find the two interface boards and the XBee Wall Router, known as nodes. In this task, you will see a network view of the nodes from the gateway's web interface.

1. Return to the home page of the gateway's web interface:

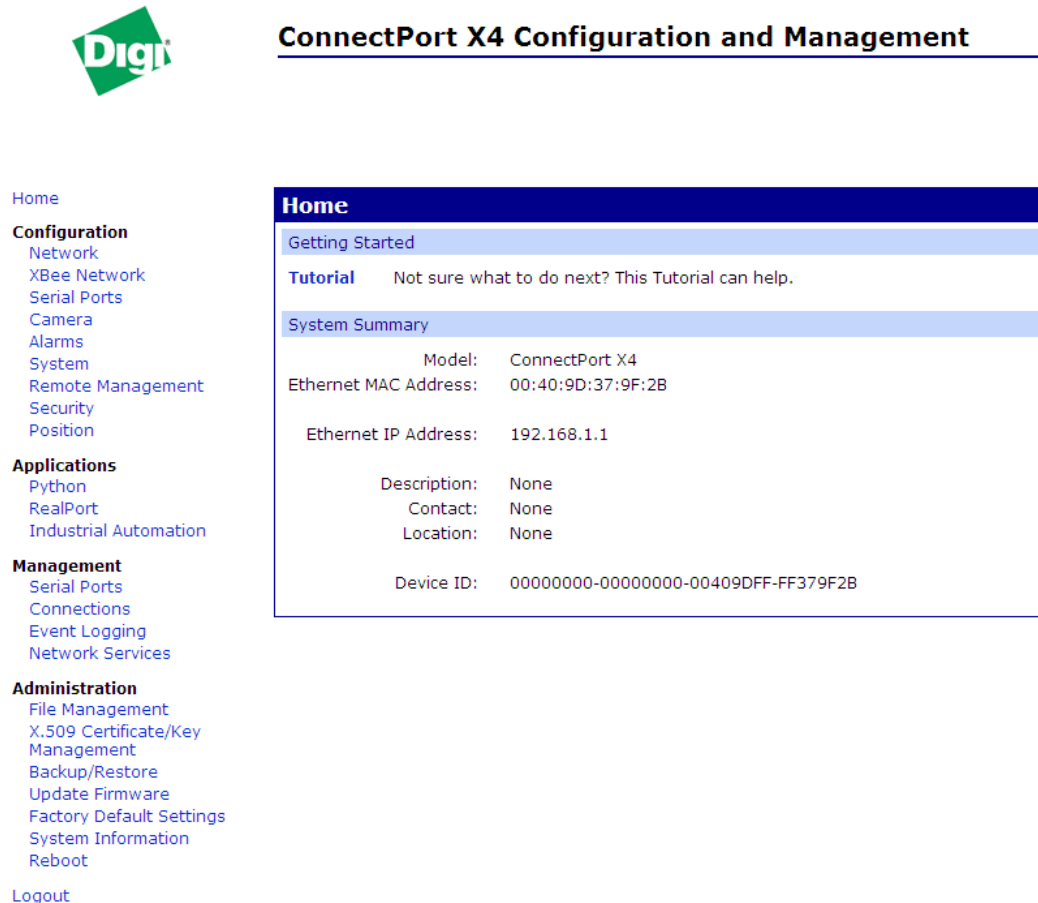

Digi

ConnectPort X4 Configuration and Management

Home

- Configuration**
 - Network
 - XBee Network
 - Serial Ports
 - Camera
 - Alarms
 - System
 - Remote Management
 - Security
 - Position
- Applications**
 - Python
 - RealPort
 - Industrial Automation
- Management**
 - Serial Ports
 - Connections
 - Event Logging
 - Network Services
- Administration**
 - File Management
 - X.509 Certificate/Key Management
 - Backup/Restore
 - Update Firmware
 - Factory Default Settings
 - System Information
 - Reboot

Logout

Home

[Getting Started](#)

Tutorial Not sure what to do next? This Tutorial can help.

System Summary

Model:	ConnectPort X4
Ethernet MAC Address:	00:40:9D:37:9F:2B
Ethernet IP Address:	192.168.1.1
Description:	None
Contact:	None
Location:	None
Device ID:	00000000-00000000-00409DFF-FF379F2B

2. From the menu on the left side, select **Administration > System Information**.

Administration

- File Management
- X.509 Certificate/Key Management
- Backup/Restore
- Update Firmware
- Factory Default Settings
- System Information**
- Reboot

3. In the list of System Information links on the **System Information** page, click **XBee Network**.

System Information

▼ General

Model:	ConnectPort X4
Ethernet MAC Address:	00:40:9D:37:9F:2B
Firmware Version:	2.8.1.15 (Version 82001536_D2 12/18/2008)
Boot Version:	1.1.3 (release_82001531_A)
POST Version:	1.1.3 (release_82001537_E)
Product VPD Version:	release_82001747_A
Product ID:	0x0074
Hardware Strapping:	0x0043
CPU Utilization:	4%
Up Time:	1 hour 22 minutes 10 seconds
Total Memory:	16384 KB
Used Memory:	10776 KB
Free Memory:	5608 KB

Refresh

- ▶ Serial
- ▶ Network
- ▶ Position
- ▶ **XBee Network**
- ▶ Watchport Sensor
- ▶ Diagnostics

Use gateway to discover nodes

- The XBee Network page is displayed. It shows several settings for the the gateway, followed by a network view of hte XBee devices, or nodes. Initially, this page will not show any nodes aside from the coordinator.

To discover nodes:

- Check **Clear list before device discovery** checkbox. This check box clears any previously read and displayed network information from the gateway's cache before the device discovery operation occurs.
- Click the **Discover XBee Devices** button.

▼ XBee Network

Gateway Device Details

PAN ID: 0xb427 - 0x7a61f59ea3c43f19
Channel: 0x16 (2460 MHz)
Gateway Address: 00:13:a2:00:40:52:92:26!

Network View of the XBee Devices

Node ID	Network Address	Extended Address	Node Type	Product Type
[0000]!		00:13:a2:00:40:52:92:26!	coordinator	X4 Gateway

Clear list before device discovery

Discover XBee Devices Device discovery in progress. Please wait...

In the **Node Type** column, the XBee module in the gateway is listed as the **coordinator**, and the XBee interface boards and XBee Wall Router are listed as **routers**.

Network View of the XBee Devices

Node ID	Network Address	Extended Address	Node Type	Product Type
[0000]!		00:13:a2:00:40:52:92:26!	coordinator	X4 Gateway
[10a2]!		00:13:a2:00:40:3e:07:68!	router	Unspecified
[5624]!		00:13:a2:00:40:0a:12:a1!	router	Unspecified
[222b]!		00:13:a2:00:40:3e:26:47!	router	Wall Router

Clear list before device discovery

Discover XBee Devices

Here is how the values in the **Type** column are assigned in the network.

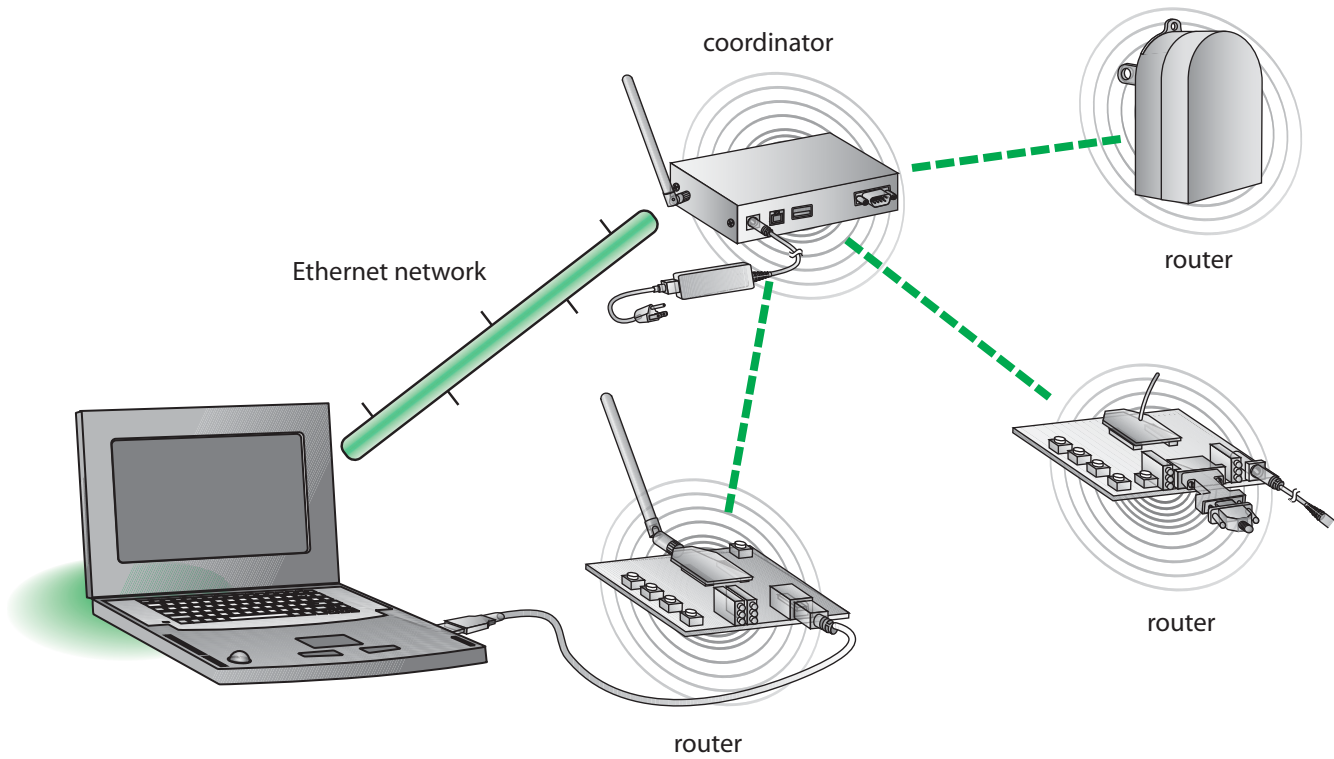

5. To refresh the view, click the **Discover XBee Devices** button.

Use gateway to discover nodes

Run gateway and PC demo applications

This kit includes two demo applications:

- An application that runs on the gateway to discover nodes, read temperature and light information from the XBee Wall Router, and establish TCP sockets to XBee nodes
- An application that runs on the PC and works with the gateway application to display information on the PC

In this task, you will install and run both applications.

Install Drop-in Networking software/documentation on PC

The gateway demo and PC companion applications are on the Hardware & Software Setup CD. Installing the gateway demo application also creates a Drop-in Networking program group and installs software and documentation.

1. Insert the **Hardware & Software Setup CD** in the CD/DVD drive of the PC. A navigation page for the CD is displayed.
2. In the list of options on the right side of the screen, click **Install Demo Application**.

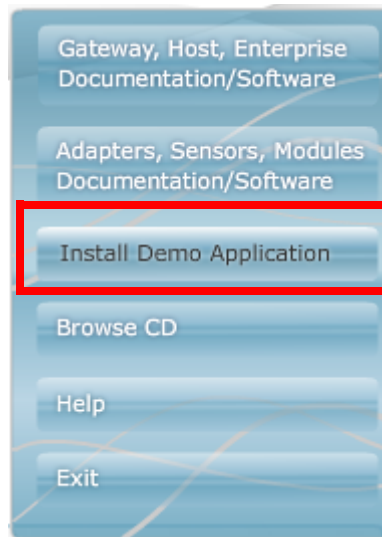

3. The **Digi Drop-in Networking Setup** wizard is launched. Follow the wizard prompts, choosing to install the demo application in the default location.

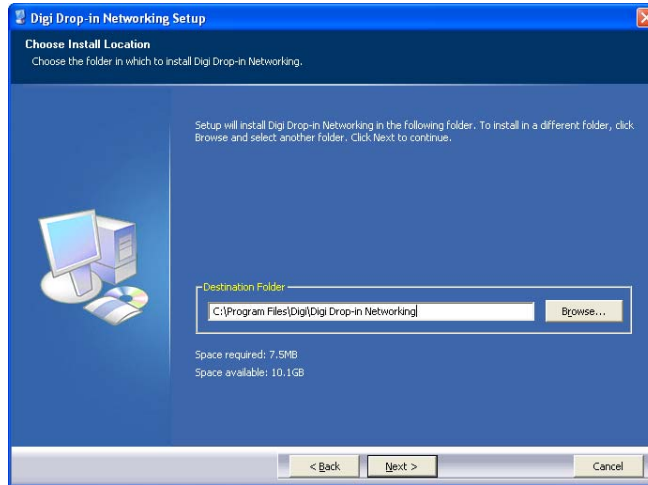

4. Click **Finish** to complete the wizard.
The gateway demo application and PC companion application that will be run later are now installed on your PC. In addition, the Drop-in Networking program group was created, which includes documentation, sample programs, and other development resources. To view it, select **Start > Programs > Digi > Digi Drop-in Networking**.

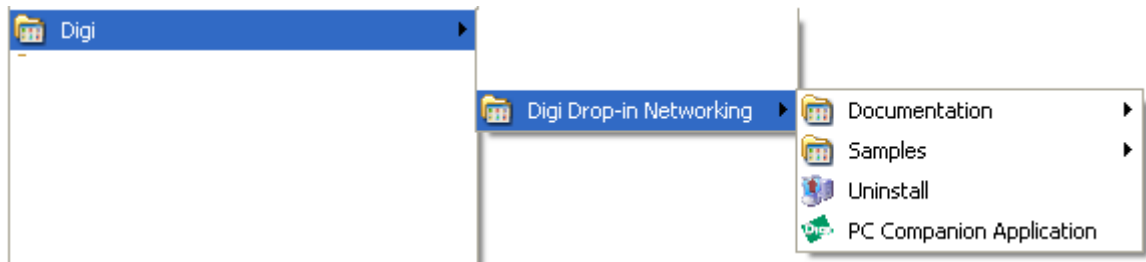

Upload the gateway demo application to gateway

Next, upload the gateway demo application from the PC to the gateway.

1. Open the web interface for the gateway.
2. From the menu on the left side, go to **Applications > Python**. The Python Configuration page is displayed.
3. In the **Upload File** edit box, use the **Browse** button to navigate to this location:

C:\Program Files\Digi\Digi Drop-in Networking\Gateway Sample
(Substitute your actual root directory as needed.).

Locate each file and click **Upload**. The files to upload are:

- **embedded_kit_gateway.zip**
- **EmbeddedKitManager.py**
- **EmbeddedKitService.py**
- **WPAN.py**

Python Configuration

▼ Python Files

Upload Files

Upload Python programs

Upload File:

When the files are uploaded, a confirmation message is displayed and the files are displayed in the **Manage Files** list.

File uploaded.

Python Configuration

▼ Python Files

Upload Files

Upload Python programs

Upload File:

Manage Files

Action	File Name	Size
<input type="checkbox"/>	embedded_kit_gateway.zip	674664 bytes
<input type="checkbox"/>	EmbeddedKitManager.py	14968 bytes
<input type="checkbox"/>	EmbeddedKitService.py	532 bytes
<input type="checkbox"/>	python.zip	70738 bytes
<input type="checkbox"/>	zigbee.py	1147 bytes

Run the gateway demo application

Start the application

1. Open a Telnet connection to the gateway, specifying the IP address of the gateway. (You can find the IP address by going back to the gateway's web interface home page, or by using the Digi Device Discovery application used in "Connect the gateway to Ethernet and discover it" on page 23.) For example:

```
C:\ Command Prompt
Microsoft Windows XP [Version 5.1.2600]
(C) Copyright 1985-2001 Microsoft Corp.
H:\>telnet 192.168.1.1
```

2. Run the application by typing the **py (python)** command, specifying the name of the gateway demo application. The command is case-sensitive; enter exactly as shown:

py EmbeddedKitService.py

```
#> py EmbeddedKitService.py
```

The application will take some time to begin.

Display nodes

The gateway demo application uses Python programming language functions to do several things.

First, the gateway demo application searches for any nodes in the range of the gateway. Four nodes are discovered and are listed by their MAC addresses:

```
#> py EmbeddedKitService.py
Starting up...
Ready for incoming requests!
Discovering nodes...
971A:[00:13:a2:00:40:0a:0c:54]!-
8FE5:[00:13:a2:00:40:0a:12:a1]!-
8C85:[00:13:a2:00:40:34:14:97]!-
57:[00:13:a2:00:40:3e:07:68]!-
```

Assign TCP socket numbers to the nodes

Next, the gateway demo application assigns a TCP port number to each node. This assignment is the key link between the XBee and Ethernet networks, and allows the demo application to communicate with each node over the Ethernet network. This operation occurs without displaying any output in the gateway demo application. Later, when you run the PC companion application, these TCP port numbers are displayed in the **TCP Port** column, as shown and described in "Display nodes" on page 40.

Assigning TCP port numbers to the nodes enables any TCPI/IP-based applications to communicate with the nodes. To demonstrate this, you can open a serial connection (Telnet) to one of the interface boards in the in the XBee network and send data back and forth.

Stop the application

To stop the application, reboot the gateway from the gateway's web interface (**Administration > Reboot**). Later, when the PC companion application is started, you can also shut down the gateway demo application from it.

Note: You must reboot the gateway to restart the gateway demo application.

Read temperature and light data from the XBee Wall Router

The gateway demo application reads the temperature and light information from the integrated sensors in the XBee Wall Router.

```
Node: [00:13:a2:00:40:34:14:97]! Time:00:02:19 Temp:22.542522 Light
Node: [00:13:a2:00:40:34:14:97]! Time:00:02:51 Temp:22.542522 Light
```

If there were more XBee products with attached or integrated sensors in the ZigBee network, the gateway demo application would display the data read by these sensors as well.

Additional XBee Sensors can be purchased at the digi online store at www.digi.com.



Run the PC companion application

The PC companion application is a Windows application that is used with the gateway demo application, **EmbeddedKitService.py**. It was installed on your PC as part of the Drop-in Networking program group in the previous step. It demonstrates interaction between a Python-based application that runs on a gateway and a Windows application that runs on a PC. It provides an easy way to get and display information from the nodes in a Drop-in Network, such as temperature and light data from the integrated sensors in the XBee Wall Router and I/O from the interface boards. When the two applications work together, the gateway demo application handles most of the data reading, and the PC companion application handles displaying the data on the PC.

Start the application

To start the PC companion application, select:

Start > Programs > Digi > Digi Drop-in Networking > PC Companion Application

Enter the IP address of the gateway:

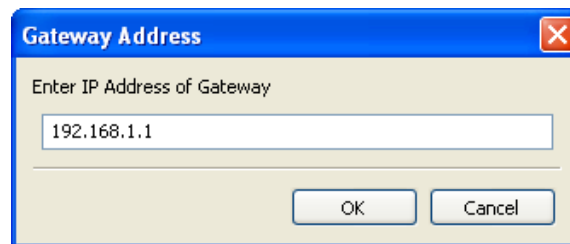

Discover nodes

The PC companion application searches for any nodes in the range of the gateway. A progress dialog is displayed during this function:

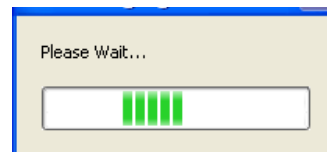

Display nodes

The discovered nodes are displayed in the **Digi Embedded Kit Gateway Viewer**, in the left window pane. Note the TCP number assigned to each node:

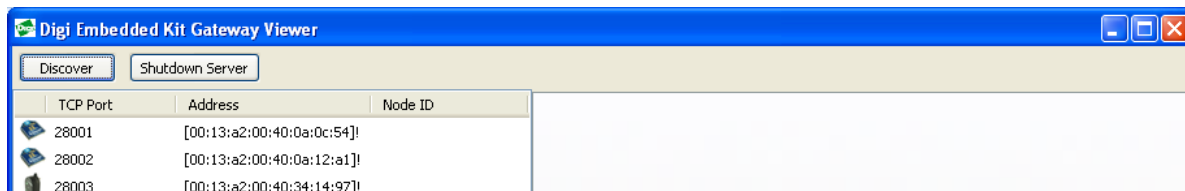

View status and read data from nodes

Click on a node. In the right pane, several tabs of status information and other data read from the unit are displayed. For example, here is the **I/O Status** tab for one of the interface boards.

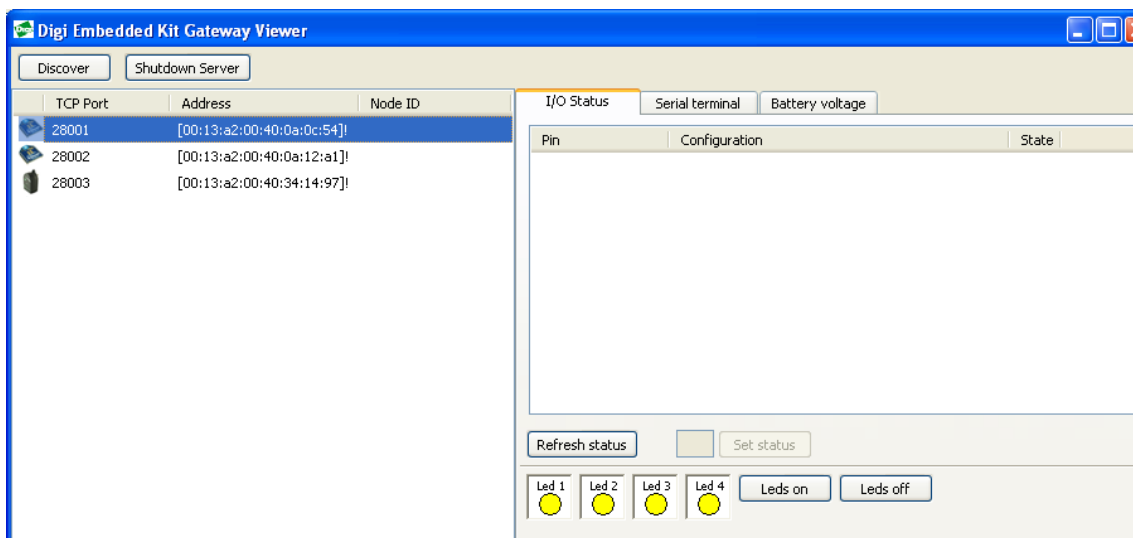

Read temperature and light information from the Wall Router

Click on the XBee Wall Router. Temperature and light data from the integrated sensors are displayed in the right pane.

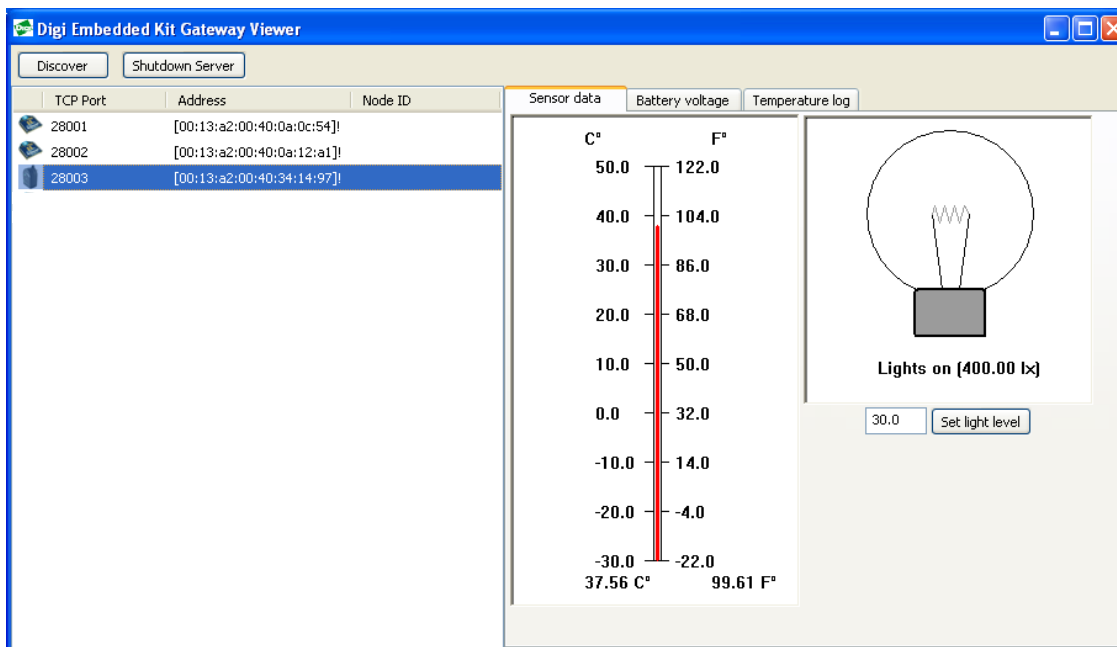

Change light on/off set point on the XBee Wall Router

On the XBee Wall Router, you can change the light level at which point the unit's sensor program considers the lights to be on or off. Select the XBee Wall Router. Enter a different value for the light on/off set point for the light sensor and click **Set Light Level**.

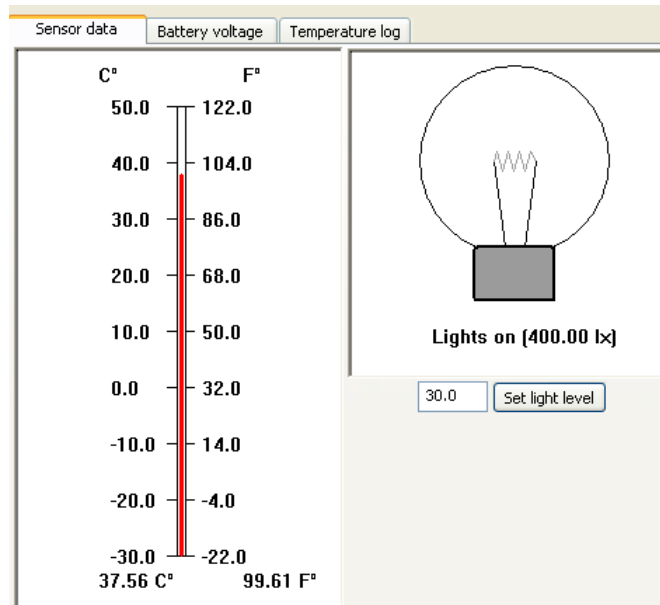

Experiment with I/O using buttons on the interface boards

1. Select one of the interface boards.
2. Click the **I/O Status** tab.
3. Click the **Leds on** button. Observe how the LEDs on the interface board, labeled LED 1 through LED 4, are turned on.
4. Click the **Leds off** button and observe how the LEDs are turned off.

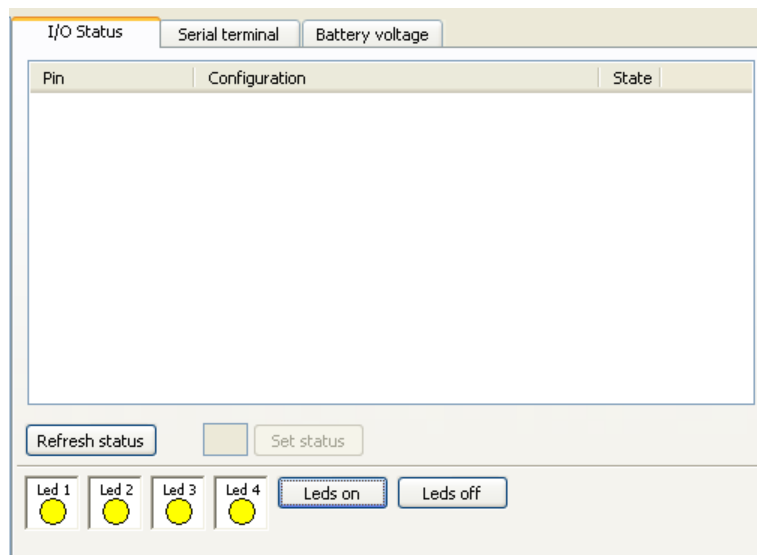

Send/receive serial data using the XBee module, interface board, and loopback adapter

1. Select the RS-232 interface board.
2. Click the **Serial terminal** tab.
3. Type some text. The text transmitted to the interface board is displayed in black. The text returned from the interface board is displayed in blue.

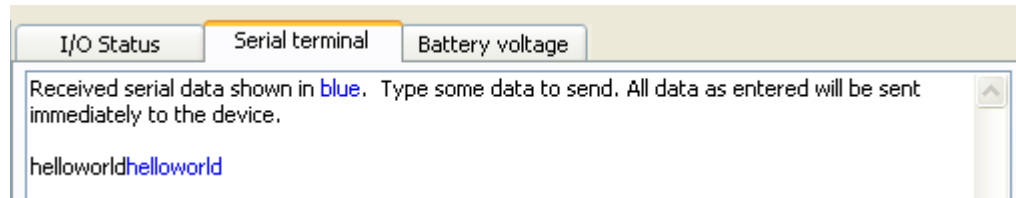

4. Remove the loopback plug from the interface board.
5. In the terminal emulator window, type some text again. Note how only black text is displayed, because no text is being returned from the XBee RS-232 interface board.

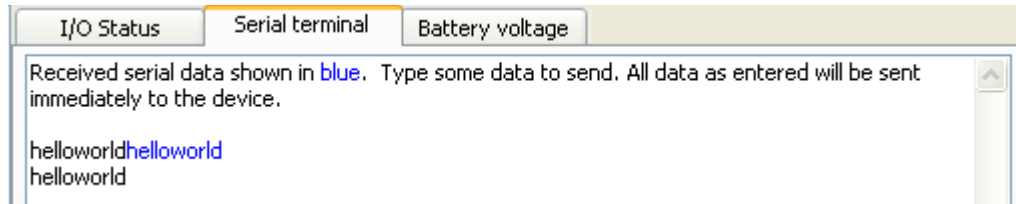

Monitor battery/voltage supply on any node

Click the **Battery voltage** tab to display the battery/voltage supply for any node. When an XBee module is powered through the interface board, the voltage will always display 3.3VDC.

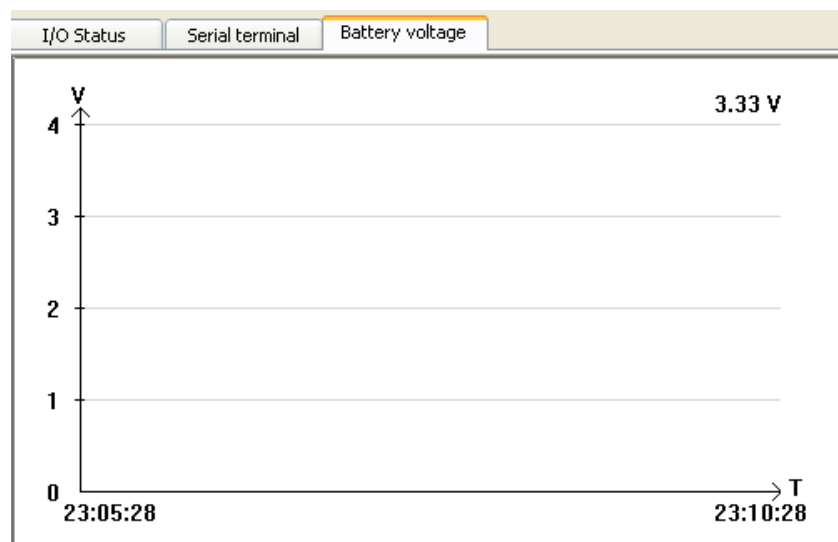

Stop the gateway demo application

Click **Shutdown Server** to stop the gateway demo application.

Note: You must reboot the gateway to restart the gateway demo application.

Change the PC companion application using Python software tools

The PC companion application is written in Python, and serves as an example for Drop-in Networking application development. A great way to get started developing in Python is to change the PC companion application.

Python is a dynamic, object-oriented language for developing software applications, from simple programs to complex embedded applications. It includes extensive libraries and works well with other languages. A true open-source language, Python runs on a wide range of operating systems. The *Digi Python Programming Guide* shows how to create and run a simple Python program, reviews Python modules, particularly modules with Digi-specific behavior and functions used in several Digi sample applications, and shows how to load and run Python programs onto Digi devices through the command line or web interfaces. This guide is available in the Drop-in Networking program group (**Start > Programs > Digi > Digi Drop-in Networking**).

Use Drop-in Networking development resources

Drop-in Networking development resources are available in the Drop-in Networking program group, the Hardware & Software Setup CD, and on the web.

To	Go to
View the source for the gateway demo application	Start > Digi > Drop-in Networking > Samples > View Gateway Sample source
View the source for the PC companion application	Start > Digi > Drop-in Networking > Samples > PC Samples > View PC Companion Application source
View gateway documentation	Start > Digi > Drop-in Networking > Documentation > Digi ConnectPort X User's Guide
Learn about the Python functions in the gateway and PC companion applications, and share Python programs with others	Visit Digi International's Python Developer Resources page at: http://www.digi.com/technology/drop-in-networking/pdr.jsp From this page, you can view the Digi Python Library and documentation, demo programs, the Digi Python Wiki page and Python support forums.
View XBee module documentation	The XBee module product manual on the Hardware & Software Setup CD. On the CD's front page, click Adapters, Sensors, Modules Documentation/Software . Click the XBee module image to browse documentation. The product manual describes module features, operation modes, and commands for controlling the module and retrieving data.
View XBee Wall Router documentation	The XBee Adapters, Routers, and Sensors User's Guide. Download this document from www.digi.com/din/docs/
View more Drop-in Networking documentation	www.digi.com/din/docs/ Browse the Hardware & Software Setup CD. On the CD's front page, click Browse CD .
Order additional Drop-in Networking products	Browse the Software and Documentation CD, and go to Digi's Drop-in Networking page at www.digi.com/din/

Manage Drop-in Networks

Congratulations!

You have successfully installed the Drop-in Networking Professional Development Kit and exercised the gateway and PC companion demo applications.

Use Connectware Manager

This kit includes a 30-day trial offer for a live demonstration version of Digi Connectware Manager. In addition, the Hardware & Software Setup CD includes a copy of Digi Connectware Manager that can be installed on your PC. Digi Connectware Manager is a device management platform that provides remote network management of all connected hardware, including devices on an XBee network. In contrast to the one-user-to-one-device model of other Digi device interfaces, Digi Connectware Manager deploys a one-user-to-many-devices model. From Digi Connectware Manager, you can provision and configure network hardware, track device performance, remotely set filters and alarms, monitor connections, reboot devices and reset defaults, and remotely upgrade firmware.

Views for managing XBee devices

Extensions to Digi Connectware Manager make it an attractive platform for managing XBee devices behind the gateway. It displays all nodes on an XBee network and allows querying for node profiles, node descriptors, connected endpoints, radio configuration settings and statistics, bindings, and more.

Several views in Digi Connectware Manager are particularly useful for managing and configuring XBee networks. The **Mesh/XBee Networks** view displays devices in the context of their XBee network, including their node ID, the network to which they belong, physical addresses, their role in the network (coordinator, router, or end node), and their defined parent in the network.

The screenshot displays the Digi Connectware Device Management software interface. The window title is "Connectware Device Management - 10.8.128.24". The interface is divided into several sections:

- Menu Bar:** File, View, Device, Group, Mesh, Help
- Navigation:** IP Networks, Mesh Networks
- Groups:** All Devices (2)
- Mesh Gateways - All Devices - Filtered:**

Device ID	Device Type	PAN ID	IP Address	Host Name	Connection Status	Last Use	Description
00000000-00000000-00409DFF-FF298D0B	ConnectPort WWAN	0x234	10.8.16.32		Disconnected	7/19/07 9:54:44 AM CDT	
- Mesh Network - Gateway: 00:13:a2:00:40:0a:06:7d!, PAN ID: 0x234:**

Node ID	Network Address	Physical Address	Type	Parent	Status
coordinator	0x0	00:13:a2:00:40:0a:06:7d!	coordinator	0xfffe	ok
xyz	0x2e5f	00:13:a2:00:40:0a:06:6e!	router	0xfffe	ok
	0x9936	00:13:a2:00:40:0a:06:d8!	router	0xfffe	ok
- Messages:** View Messages
- Status Bar:** Ready, Mesh Nodes (0 of 3 selected)

More detailed views of nodes can be accessed from the **Mesh/XBee Networks** view. Here are the **Radio** and **Summary** tabs of a node's **Device Properties** view.

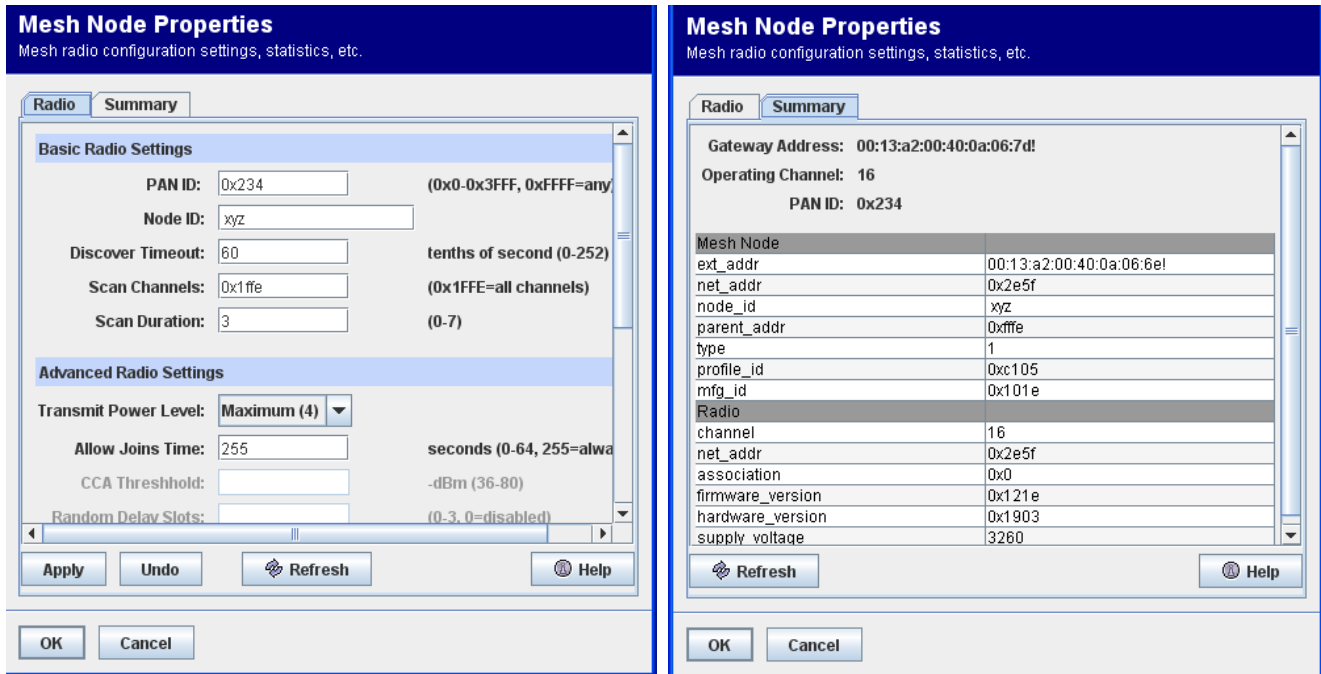

Digi Connectware Manager product information

You can obtain the latest version of Connectware Manager from Digi's Support site.

For more information about Digi Connectware Manager, see the *Connectware Manager Getting Started Guide* on the Hardware & Software Setup CD.

Contact Digi

As you move from running demo applications to deploying an actual Drop-in Network, feel free to contact Digi to discuss the next steps of your solution.



PN:(1P) 90001040-88 A



Стандарт Электрон Связь

Мы молодая и активно развивающаяся компания в области поставок электронных компонентов. Мы поставляем электронные компоненты отечественного и импортного производства напрямую от производителей и с крупнейших складов мира.

Благодаря сотрудничеству с мировыми поставщиками мы осуществляем комплексные и плановые поставки широчайшего спектра электронных компонентов.

Собственная эффективная логистика и склад в обеспечивает надежную поставку продукции в точно указанные сроки по всей России.

Мы осуществляем техническую поддержку нашим клиентам и предпродажную проверку качества продукции. На все поставляемые продукты мы предоставляем гарантию .

Осуществляем поставки продукции под контролем ВП МО РФ на предприятия военно-промышленного комплекса России , а также работаем в рамках 275 ФЗ с открытием отдельных счетов в уполномоченном банке. Система менеджмента качества компании соответствует требованиям ГОСТ ISO 9001.

Минимальные сроки поставки, гибкие цены, неограниченный ассортимент и индивидуальный подход к клиентам являются основой для выстраивания долгосрочного и эффективного сотрудничества с предприятиями радиоэлектронной промышленности, предприятиями ВПК и научно-исследовательскими институтами России.

С нами вы становитесь еще успешнее!

Наши контакты:

Телефон: +7 812 627 14 35

Электронная почта: sales@st-electron.ru

Адрес: 198099, Санкт-Петербург,
Промышленная ул, дом № 19, литера Н,
помещение 100-Н Офис 331