



Industrial



FEATURES AND BENEFITS

Meets DoE efficiency level VI requirements

- No load input power
- Average efficiency

Up to 120W of AC-DC power

Universal input 90-264Vac input range

IPX-2 rated enclosure for protection against liquid ingress

Meets "Heavy Industrial" levels of EN61000 EMC requirements

Meets EN55011/CISPR11, FCC Part 15.109 Class B conducted & radiated emissions, with 6db margin

Approved to EN/IEC/UL60950-1, 2nd Edition, Am. 2

E-cap life of >7 years

3 years warranty

RoHS/REACH compliant



MODEL SELECTION

Model Number	Volts	Output Current	Output Power	Ripple & Noise ¹	Line Regulation	Load Regulation	Output Cable & Connector	Input Configuration
TE120A1251F01	12.0V	10.0A	120W	120mV pk-pk	±1%	±5%	4 cond. #18AWG; 6 pin Molex Type conn. ²	Class I Desktop, IEC60320 C14 Receptacle
TE120A1551F01	15.0V	8.00A	120W	150mV pk-pk	±1%	±5%	4 cond. #18AWG; 2.5 x 5.5 x 9.5mm Straight Barrel Type conn., center positive	
TE120A1803F01	18.0V	6.67A	120W	180mV pk-pk	±1%	±5%		
TE120A2403F01	24.0V	5.00A	120W	240mV pk-pk	±1%	±5%		
TE120A1251N01	12.0V	10.0A	120W	120mV pk-pk	±1%	±5%	4 cond. #18AWG; 6 pin Molex Type conn. ²	Class II Desktop, IEC60320 C8 Receptacle
TE120A1551N01	15.0V	8.00A	120W	150mV pk-pk	±1%	±5%	4 cond. #18AWG; 2.5 x 5.5 x 9.5mm Straight Barrel Type conn., center positive	
TE120A1803N01	18.0V	6.67A	120W	180mV pk-pk	±1%	±5%		
TE120A2403N01	24.0V	5.00A	120W	240mV pk-pk	±1%	±5%		
TE120A1251Q01	12.0V	10.0A	120W	120mV pk-pk	±1%	±5%	4 cond. #18AWG; 6 pin Molex Type conn. ²	Class II Desktop, IEC60320 C18 Receptacle
TE120A1551Q01	15.0V	8.00A	120W	150mV pk-pk	±1%	±5%	4 cond. #18AWG; 2.5 x 5.5 x 9.5mm Straight Barrel Type conn., center positive	
TE120A1803Q01	18.0V	6.67A	120W	180mV pk-pk	±1%	±5%		
TE120A2403Q01	24.0V	5.00A	120W	240mV pk-pk	±1%	±5%		

- Notes :**
1. Measured at the output connector, with noise probe directly across output and load, terminated with 0.1µF ceramic and 47µF low ESR capacitors.
 2. Molex p/n 39-01-2060 or equivalent. See outline drawing for pinout information.
 3. For Input Class I models: For AC GND connected to output common (-), insert a "B" in the part number where the "A" is located (TE120B1251F01).
 4. All specifications are typical at nominal input, full load, at 25°C ambient unless noted.
 5. Other connector options available, contact factory, or visit www.slpower.com.



INPUT

AC Input	100-240Vac, $\pm 10\%$, 47-63Hz, 1 ϕ
Input Current	100Vac: 1.5A, 230Vac: 0.7A
Inrush Current	264Vac, cold start: will not exceed 40A peak
Input Fuses	F1, F2: 3.15A, 250Vac fuses (line & neutral lines) provided on all models
Earth Leakage Current (Input to Ground)	Input-GND: $500\mu\text{A}$@264Vac, 60Hz, NC Output-GND: 4mA@264Vac, 60Hz, NC
Efficiency	Meets US DoE efficiency level VI average efficiency levels
No Load Input Power	0.210W per DoE efficiency level VI requirements

OUTPUT

Hold-up Time	20mS min., at full Load, 100Vac input
Turn On Time	Less than 1 sec @115Vac, full load
Output Power	120W continuous - See models chart for specific voltage model ratings
Output Voltage	See models chart on pg 1
Ripple and Noise	See models chart on pg 1
Transient Response	500 μs response time for return to within 0.5% of final value for any 50% load step over the range of 5% to 100% of rated load, $\Delta i/\Delta t < 0.2\text{A}/\mu\text{s}$. Max. voltage deviation is $\pm 3.5\%$

PROTECTION

Overtemperature Protection	Will shutdown upon an over-temperature condition, auto-recovery
Overload Protection	130 to 180% of rating, Hiccup Mode
Short Circuit Protection	Hiccup Mode, auto recovery
Overvoltage Protection	130 to 150% of output voltage (max. 60V on 48V model), hiccup mode
Safety Drop Test	1.4m from table top to wooden platform, 6 faces

SAFETY

Safety Standards	EN/CSA/UL/IEC 60950-1, 2nd Edition, Am 2
Shock	Operating: Half-sine, 20gpk, 10mS, 3 axes, 6 shocks total Non-Operating: Half-sine waveform, impact acceleration of 50G, Pulse duration of 6mS, Number of shocks: 3 for each of the three axis

ISOLATION SPECIFICATION

Isolation	Input - Output: 4000Vac Input - Ground: 1500Vac Output - Ground: 1500Vac
-----------	--

RELIABILITY

MTBF	>250,000 hours, full load, 110 & 220Vac input, 25°C amb., per Telcordia 332 Issue 6
E-Cap Life	>7 year life based on calculations at 115Vac/60Hz & 230Vac/50Hz, ambient 25°C at 24 hrs per day, 365 days/year, 6 power up cycles per day (80% load on 12V model)

ENVIRONMENT

Operating Temperature	-20°C to +50°C. Derate above 50°C
Storage Temperature	-40°C to +85°C
Temperature Derating	See Derating Curve
Case Temperature	Case Temperatures are within regulatory guidelines. Power Supply unit should not be covered or enclosed to ensure proper heat dissipation
Altitude	Operating: to 5000m (derate to TBD temp. above 3000m) Non-operating: -500 to 40,000 ft.
Relative Humidity	5% to 95%, non-condensing
Vibration	Operating: 0.003g/Hz, 1.5grms overall, 3 axes, 10 min/axis, 1-500Hz. Non-operating: random waveform, 3 minutes per axis, 3 axes and Sine waveform, Vib. Frequency/Acceleration: 10-500Hz/1g, sweep rate of 1 octave / minutes, Vibration time of 10 sweeps / axes, 3 axes
Dimensions	W: 2.65" x L: 8.3" x H: 1.7" W: 67.4mm x L: 212.4mm x H: 44.25mm
Weight	710g

All specifications are typical at nominal input, full load, at 25°C ambient unless noted.



EMI/EMC COMPLIANCE

Conducted Emissions	EN55011/CISPR22 Class B, FCC Part 15.107, Class B: 6db margin typ, at 115 and 230Vac
Radiated Emissions	EN55022/CISPR22 Class B, FCC Part 15.109, Class B: 3db margin typ, at 115 and 230Vac
Common Mode Noise	High Frequency (100kHz-20MHz): <40mA pk-pk
Electro-Static Discharge (ESD) Immunity on Power ports	EN55024/IEC61000-4-2, Level 4: +/- 8kV contact, +/- 15kV air, Criteria A
Radiated RF EM Fields Susceptibility	EN55022/EN61000-4-3, 10V/m, 80MHz-2.7GHz, 80% AM at 1kHz
Electrical Fast Transients (EFT) /Bursts	EN55024/IEC61000-4-4, Level 4, +/- 4.4kV, 100Khz rep rate, 40A, Criteria A
Surges, Line to Line (Diff Mode) and Line to GND (CMN Mode)	EN55024/IEC61000-4-5, Level 4, +/-2kV DM, +/-4kV CM, Criteria A
Conducted Disturbances induced by RF Fields	EN55022/IEC61000-4-6, 10Vrms – Level 4, in ISM and amateur radio bands between 0.15Mhz and 80Mhz, 80% AM at 1KHz
Rated Power frequency magnetic fields	EN55024/IEC1000-4-8, Level 4: 30 A/m, 50/60 Hz
Voltage Interruptions, Dips, Sags & Surges	EN55024/IECEN61000-4-11: --100% dip for 20mS, Criteria A --100% dip for 500mS (250/300 cycles), Criteria B --60% dip for 100mS, Criteria B --30% dip for 500mS, Criteria A
Harmonic Current Emissions	EN55011/EN61000-3-2, Class A
Flicker Test	EN61000-3-3

MECHANICAL DRAWING

Mechanical Drawing (12V, 15V Models):

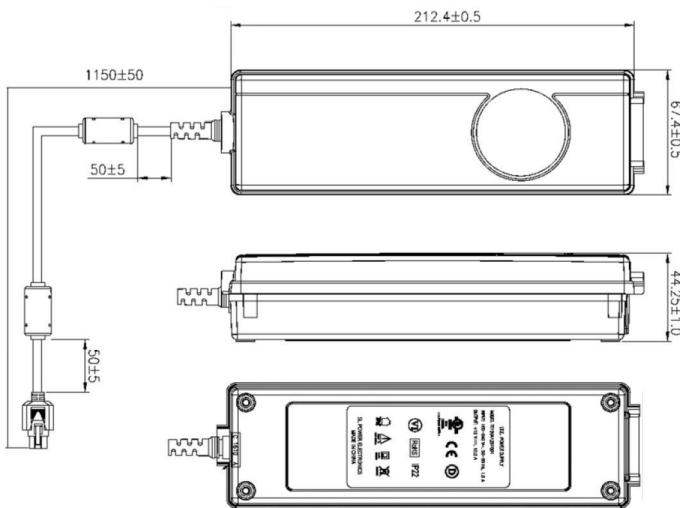

Output Connector: 6 pin Molex 39-01-2060 or equiv. Pins 1, 4 = (+), pins 3, 6 = (-), pins 2, 5 = NC

Mechanical Drawing (18V, 24V models):

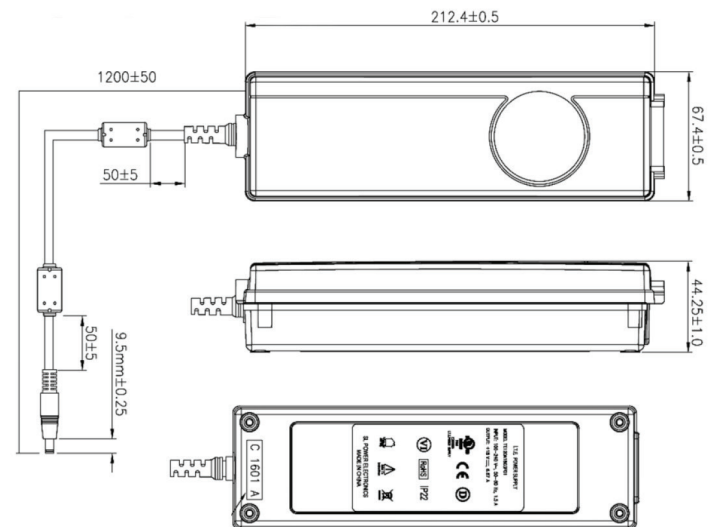

Output Connector: 2.5 x 5.5 x 9.5mm straight barrel type, center positive.

- Notes :**
1. All dimensions in mm.
 2. Other connector options available. See below.
 3. The unit should not be covered or enclosed to protect against excessive case temperature rise.



CONNECTOR INFORMATION

Standard models include a 2.5 x 5.5 x 9.5mm straight barrel type connector (Ault #3), center positive. (#51 for the 12V models). Other standard options are listed below. The "03" in the standard model number is replaced by the applicable digits below:

Connector No.	Description	Connector No.	Description
02	2.0 x 5.5 x 9.5 mm straight barrel plug - Center Positive	44	2.0 x 5.5 x 9.5 mm straight barrel plug, locking - Center positive
03	2.5 x 5.5 x 9.5 mm straight barrel plug - Center Positive (Standard models)	45	2.5 x 5.5 x 9.5 mm straight barrel plug, locking - Center positive
12	5 pin DIN-180 male connector (Pins 3, 5 = (+), pins 1, 2, 4 = (-))	48	3 pin Snap n Lock, Kycon Kpp-3P or equivalent (Pin 1 = (+), pin 2 =(-))
22	6 pin DIN male connector (Pins 1, 2 = (+), pins 4, 5 = (-))	49	4 pin Snap n Lock, Kycon Kpp-4P or equivalent (Pins 1, 3 = (+), pins 2, 4 = (-))
23	8 pin DIN male connector (Pins 3, 7 = (+), pins 1, 4, 6, 8 = (-), shell = FG)	51	6 pin Minifit - Molex 39-01-2060 or equivalent (Pins 1, 4 = (+), pins 3, 6 = (-))
32	9 pin "D" type, female (Pins 8 = (+), pins 5=(-), all others = NC)	65	Stripped and Tinned Leads
33	2.5 x 5.5 x 12.5 mm straight barrel plug - Center positive	70	2.0 x 5.5 x 11 mm right angle barrel plug (high retention) Center positive
40	2.0 x 5.5 x 9.5 mm right angle barrel plug (high retention) Center positive	71	2.5 x 5.5 x 11 mm right angle barrel plug (high retention) Center positive
41	2.5 x 5.5 x 9.5 mm right angle barrel plug (high retention) Center positive	72	2.0 x 5.5 x 9.5 mm straight barrel plug (high retention, no spark) Center positive
42	2.0 x 5.5 x 11 mm straight barrel plug (high retention) Center positive	73	2.5 x 5.5 x 9.5 mm straight barrel plug (high retention, no spark) Center positive
43	2.5 x 5.5 x 11 mm straight barrel plug (high retention) Center positive	74	EIAJ#5 style connector - Central positive

DERATING CURVE

TE120 Series Derating Curve
All models

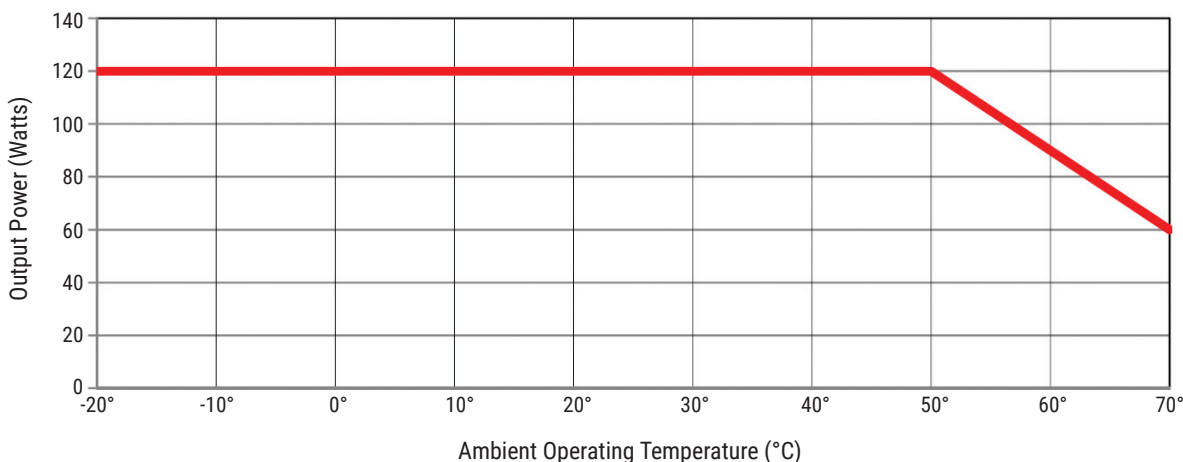



EFFICIENCY LEVEL VI INFORMATION

Single-Voltage External AC-DC Power Supply, Basic-Voltage		
Nameplate Output Power (P_{out})	Minimum Average Efficiency in Active Mode (expressed as a decimal)	Maximum Power in No-Load Mode [W]
$P_{out} \leq 1\text{ W}$	$\geq 0.5 \times P_{out} + 0.16$	≤ 0.100
$1\text{ W} < P_{out} \leq 49\text{ W}$	$\geq 0.071 \times \ln(P_{out}) \text{ ---}$ $0.0014 \times P_{out} + 0.67$	≤ 0.100
$49\text{ W} < P_{out} \leq 250\text{ W}$	≥ 0.880	≤ 0.210
$P_{out} > 250\text{ W}$	≥ 0.875	≤ 0.500
Single-Voltage External AC-DC Power Supply, Low-Voltage		
Nameplate Output Power (P_{out})	Minimum Average Efficiency in Active Mode (expressed as a decimal)	Maximum Power in No-Load Mode [W]
$P_{out} \leq 1\text{ W}$	$\geq 0.517 \times P_{out} + 0.087$	≤ 0.100
$1\text{ W} < P_{out} \leq 49\text{ W}$	$\geq 0.0834 \times \ln(P_{out}) \text{ ---}$ $0.0014 \times P_{out} + 0.609$	≤ 0.100
$49\text{ W} < P_{out} \leq 250\text{ W}$	≥ 0.870	≤ 0.210
$P_{out} > 250\text{ W}$	≥ 0.875	≤ 0.500

TE120 Series



Стандарт Электрон Связь

Мы молодая и активно развивающаяся компания в области поставок электронных компонентов. Мы поставляем электронные компоненты отечественного и импортного производства напрямую от производителей и с крупнейших складов мира.

Благодаря сотрудничеству с мировыми поставщиками мы осуществляем комплексные и плановые поставки широчайшего спектра электронных компонентов.

Собственная эффективная логистика и склад в обеспечивает надежную поставку продукции в точно указанные сроки по всей России.

Мы осуществляем техническую поддержку нашим клиентам и предпродажную проверку качества продукции. На все поставляемые продукты мы предоставляем гарантию .

Осуществляем поставки продукции под контролем ВП МО РФ на предприятия военно-промышленного комплекса России , а также работаем в рамках 275 ФЗ с открытием отдельных счетов в уполномоченном банке. Система менеджмента качества компании соответствует требованиям ГОСТ ISO 9001.

Минимальные сроки поставки, гибкие цены, неограниченный ассортимент и индивидуальный подход к клиентам являются основой для выстраивания долгосрочного и эффективного сотрудничества с предприятиями радиоэлектронной промышленности, предприятиями ВПК и научно-исследовательскими институтами России.

С нами вы становитесь еще успешнее!

Наши контакты:

Телефон: +7 812 627 14 35

Электронная почта: sales@st-electron.ru

Адрес: 198099, Санкт-Петербург,
Промышленная ул, дом № 19, литера Н,
помещение 100-Н Офис 331