

Standard Rectifier Module

$$V_{RRM} = 2 \times 1200 \text{ V}$$

$$I_{FAV} = 300 \text{ A}$$

$$V_F = 1 \text{ V}$$

Phase leg

Part number

MDD310-12N1

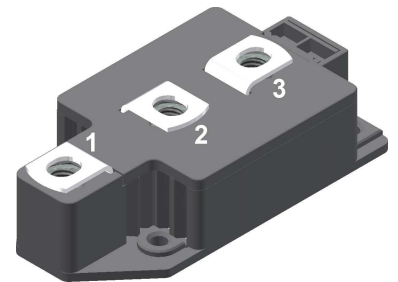

Backside: isolated

 E72873



Features / Advantages:

- Package with DCB ceramic
- Improved temperature and power cycling
- Planar passivated chips
- Very low forward voltage drop
- Very low leakage current

Applications:

- Diode for main rectification
- For single and three phase bridge configurations
- Supplies for DC power equipment
- Input rectifiers for PWM inverter
- Battery DC power supplies
- Field supply for DC motors

Package: Y2

- Isolation Voltage: 3600 V~
- Industry standard outline
- RoHS compliant
- Height: 30 mm
- Base plate: DCB ceramic
- Reduced weight
- Advanced power cycling

Disclaimer Notice

Information furnished is believed to be accurate and reliable. However, users should independently evaluate the suitability of and test each product selected for their own applications. Littelfuse products are not designed for, and may not be used in, all applications. Read complete Disclaimer Notice at www.littelfuse.com/disclaimer-electronics.

Rectifier				Ratings			
Symbol	Definition	Conditions	min.	typ.	max.	Unit	
V_{RSM}	max. non-repetitive reverse blocking voltage				1300	V	
V_{RRM}	max. repetitive reverse blocking voltage				1200	V	
I_R	reverse current	$V_R = 1200\text{ V}$			1	mA	
		$V_R = 1200\text{ V}$			20	mA	
V_F	forward voltage drop	$I_F = 300\text{ A}$			1.13	V	
		$I_F = 600\text{ A}$			1.33	V	
		$I_F = 300\text{ A}$	$T_{VJ} = 125^\circ\text{C}$			1.00	V
		$I_F = 600\text{ A}$				1.29	V
I_{FAV}	average forward current	$T_C = 100^\circ\text{C}$			300	A	
$I_{F(RMS)}$	RMS forward current	180° sine			480	A	
V_{F0}	threshold voltage	} for power loss calculation only			0.75	V	
r_F	slope resistance				0.63	mΩ	
R_{thJC}	thermal resistance junction to case				0.13	K/W	
R_{thCH}	thermal resistance case to heatsink			0.04		K/W	
P_{tot}	total power dissipation				960	W	
I_{FSM}	max. forward surge current	$t = 10\text{ ms}; (50\text{ Hz}), \text{ sine}$	$T_{VJ} = 45^\circ\text{C}$			11.5	kA
		$t = 8,3\text{ ms}; (60\text{ Hz}), \text{ sine}$	$V_R = 0\text{ V}$			12.4	kA
		$t = 10\text{ ms}; (50\text{ Hz}), \text{ sine}$	$T_{VJ} = 150^\circ\text{C}$			9.78	kA
		$t = 8,3\text{ ms}; (60\text{ Hz}), \text{ sine}$	$V_R = 0\text{ V}$			10.6	kA
I^2t	value for fusing	$t = 10\text{ ms}; (50\text{ Hz}), \text{ sine}$	$T_{VJ} = 45^\circ\text{C}$			661.3	kA ² s
		$t = 8,3\text{ ms}; (60\text{ Hz}), \text{ sine}$	$V_R = 0\text{ V}$			641.7	kA ² s
		$t = 10\text{ ms}; (50\text{ Hz}), \text{ sine}$	$T_{VJ} = 150^\circ\text{C}$			477.8	kA ² s
		$t = 8,3\text{ ms}; (60\text{ Hz}), \text{ sine}$	$V_R = 0\text{ V}$			463.5	kA ² s
C_J	junction capacitance	$V_R = 400\text{ V}; f = 1\text{ MHz}$	$T_{VJ} = 25^\circ\text{C}$		381	pF	



Package Y2			Ratings			
Symbol	Definition	Conditions	min.	typ.	max.	Unit
I_{RMS}	RMS current	per terminal			600	A
T_{VJ}	virtual junction temperature		-40		150	°C
T_{op}	operation temperature		-40		125	°C
T_{stg}	storage temperature		-40		125	°C
Weight				254		g
M_D	mounting torque		2.5		5	Nm
M_T	terminal torque		12		15	Nm
$d_{Spp/App}$	creepage distance on surface striking distance through air	terminal to terminal	13.0			mm
$d_{Spb/Apb}$		terminal to backside	13.0			mm
V_{ISOL}	isolation voltage	t = 1 second	3600			V
		t = 1 minute	3000			V

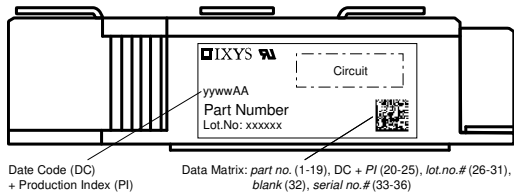

Ordering	Ordering Number	Marking on Product	Delivery Mode	Quantity	Code No.
Standard	MDD310-12N1	MDD310-12N1	Box	2	429155

Equivalent Circuits for Simulation

* on die level

$T_{VJ} = 150^{\circ}C$



Rectifier

$V_{0\ max}$	threshold voltage	0.75	V
$R_{0\ max}$	slope resistance *	0.4	mΩ



Outlines Y2

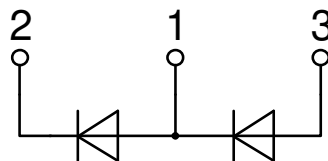
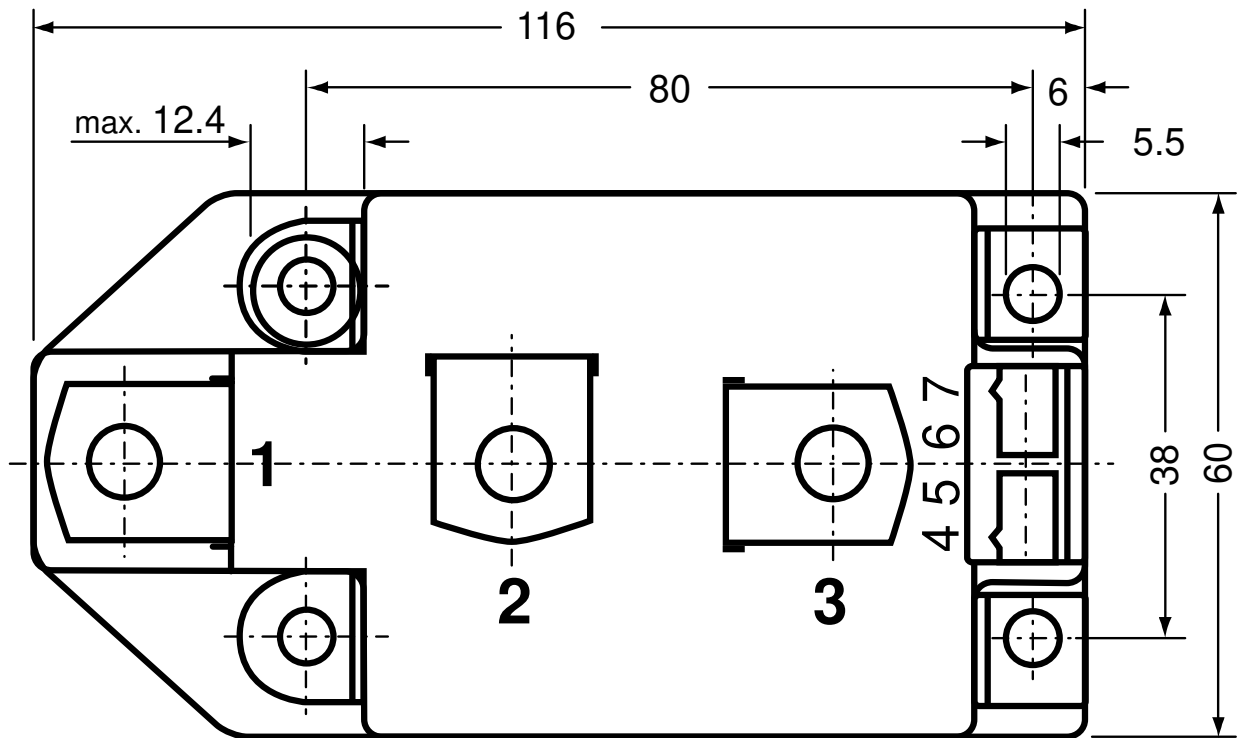
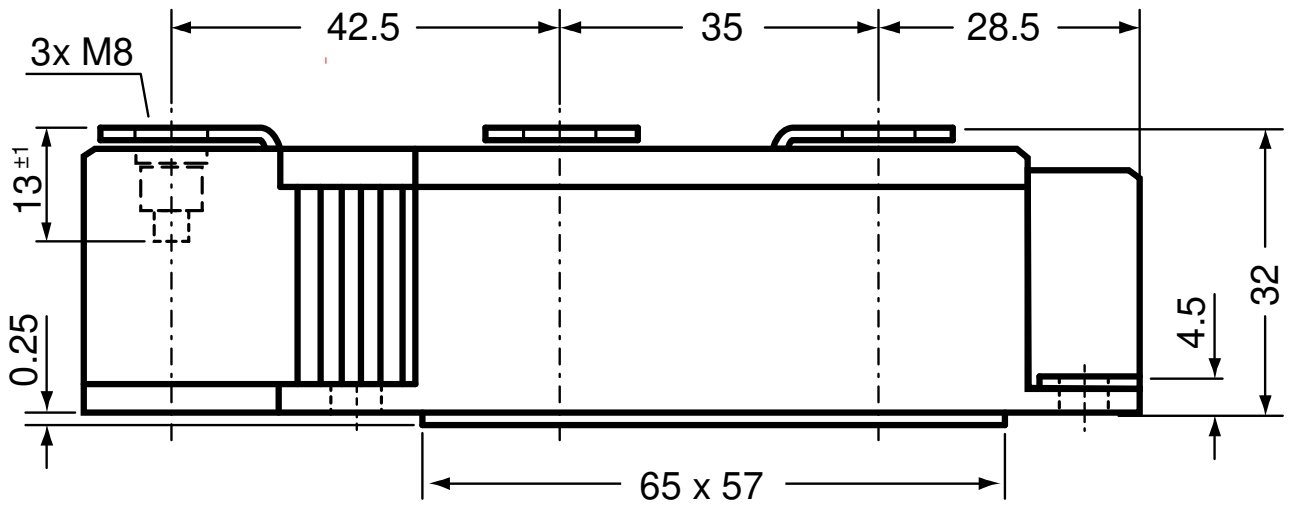

Rectifier

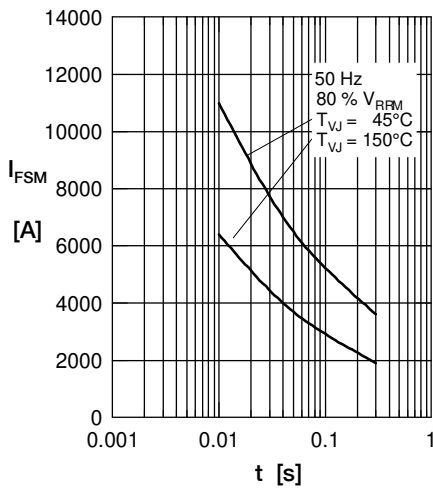

Fig. 1 Surge overload current
 I_{FSM} : Crest value, t : duration

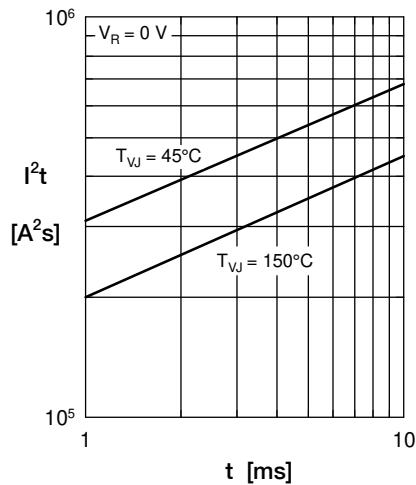

Fig. 2 I^2t versus time (1-10 ms)

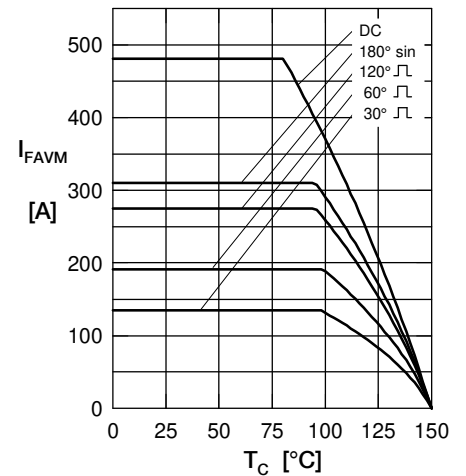

Fig. 3 Maximum forward current at case temperature

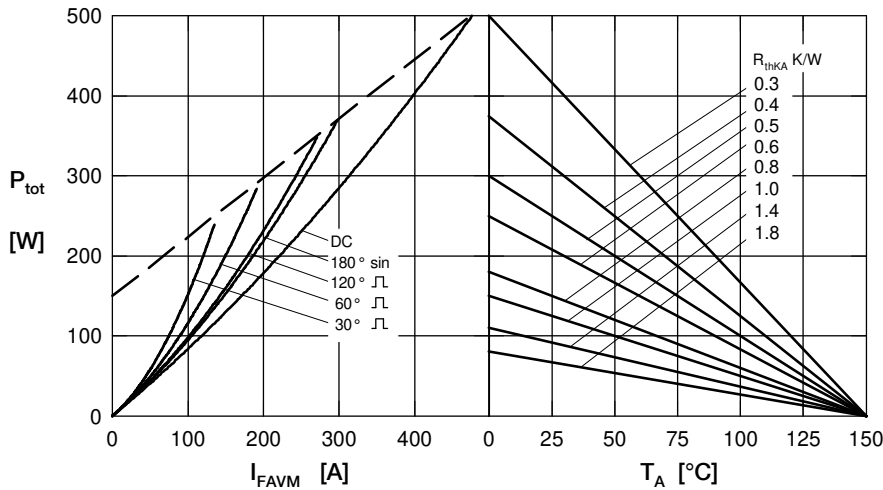

Fig. 4 Power dissipation versus forward current and ambient temperature (per diode)

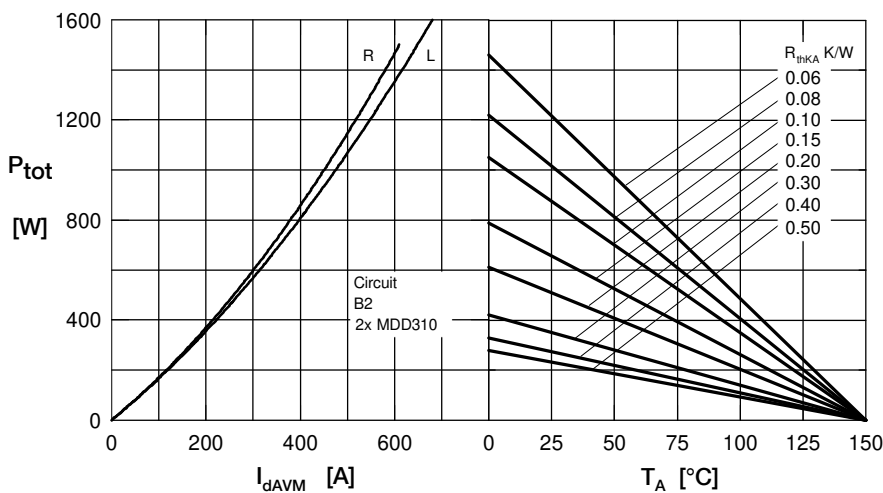

Fig. 5 Single phase rectifier bridge: Power dissipation vs. direct output current and ambient temperature R = resistive load, L = inductive load



Rectifier

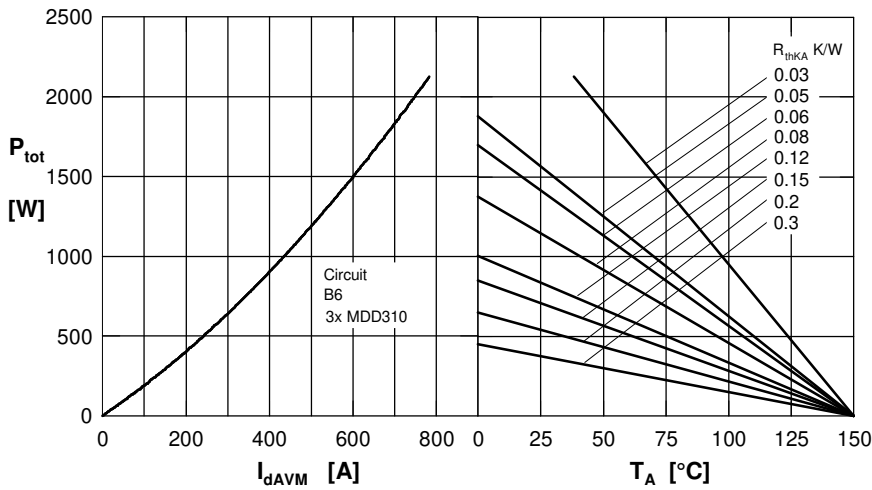

Fig.6 Three phase rectifier bridge: Power dissipation versus direct output current and ambient temperature

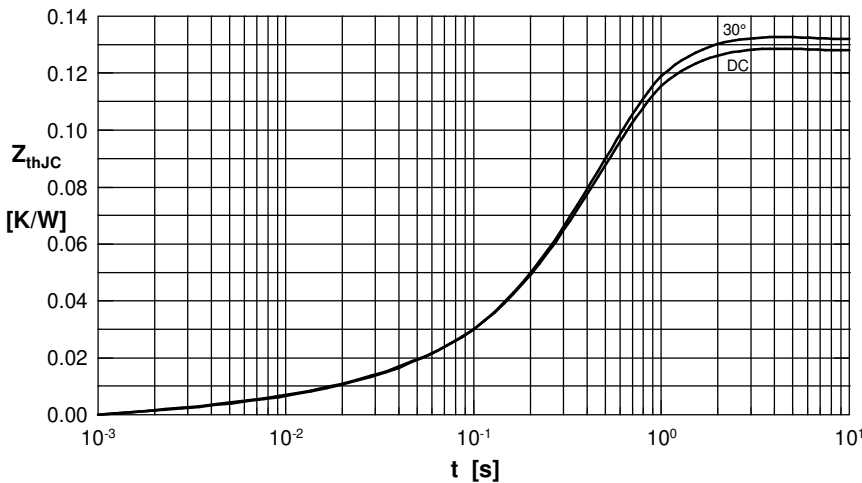

Fig. 7 Transient thermal impedance junction to case (per diode)

R_{thJC} for various conduction angles d .

d	R_{thJC} [K/W]
DC	0.129
180°	0.131
120°	0.132
60°	0.132
30°	0.133

Constants for Z_{thJC} calculation:

i	R_{thi} [K/W]	t_i [s]
1	0.0035	0.0099
2	0.0165	0.1680
3	0.1091	0.4560

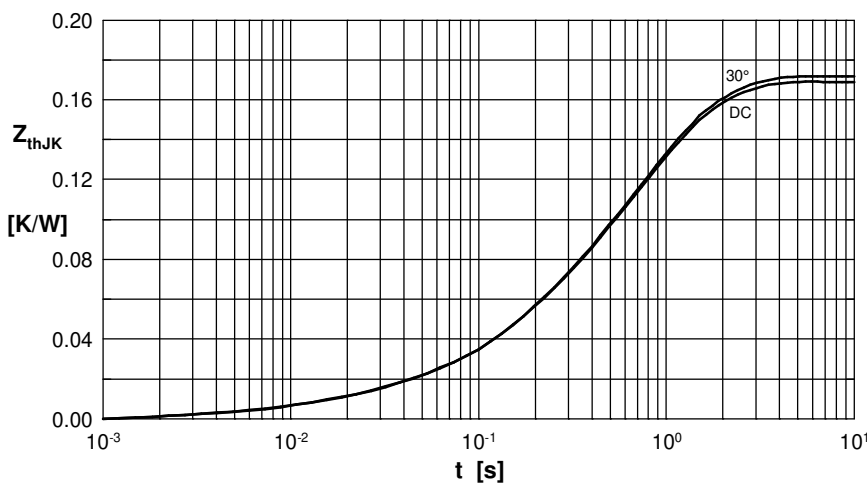

Fig. 8 Transient thermal impedance junction to heatsink (per diode)

R_{thJK} for various conduction angles d .

d	R_{thJK} [K/W]
DC	0.169
180°	0.171
120°	0.172
60°	0.172
30°	0.173

Constants for Z_{thJK} calculation:

i	R_{thi} (K/W)	t_i (s)
1	0.0035	0.0099
2	0.0165	0.1680
3	0.1091	0.4560
4	0.0400	1.3600



Стандарт Электрон Связь

Мы молодая и активно развивающаяся компания в области поставок электронных компонентов. Мы поставляем электронные компоненты отечественного и импортного производства напрямую от производителей и с крупнейших складов мира.

Благодаря сотрудничеству с мировыми поставщиками мы осуществляем комплексные и плановые поставки широчайшего спектра электронных компонентов.

Собственная эффективная логистика и склад в обеспечивает надежную поставку продукции в точно указанные сроки по всей России.

Мы осуществляем техническую поддержку нашим клиентам и предпродажную проверку качества продукции. На все поставляемые продукты мы предоставляем гарантию .

Осуществляем поставки продукции под контролем ВП МО РФ на предприятия военно-промышленного комплекса России , а также работаем в рамках 275 ФЗ с открытием отдельных счетов в уполномоченном банке. Система менеджмента качества компании соответствует требованиям ГОСТ ISO 9001.

Минимальные сроки поставки, гибкие цены, неограниченный ассортимент и индивидуальный подход к клиентам являются основой для выстраивания долгосрочного и эффективного сотрудничества с предприятиями радиоэлектронной промышленности, предприятиями ВПК и научно-исследовательскими институтами России.

С нами вы становитесь еще успешнее!

Наши контакты:

Телефон: +7 812 627 14 35

Электронная почта: sales@st-electron.ru

Адрес: 198099, Санкт-Петербург,
Промышленная ул, дом № 19, литера Н,
помещение 100-Н Офис 331