

Cree® XLamp® XP-C LEDs



PRODUCT DESCRIPTION

The XLamp XP-C LED combines the proven lighting-class performance and reliability of the XLamp XR-E LED in a package with 80% smaller footprint. The XLamp XP-C LED continues Cree’s history of innovation in LEDs for lighting applications with wide viewing angle, symmetrical package, unlimited floor life and electrically neutral thermal path.

Cree XLamp LEDs bring high performance and quality of light to a wide range of lighting applications, including color-changing lighting, portable and personal lighting, outdoor lighting, indoor directional lighting, commercial lighting and emergency-vehicle lighting.

FEATURES

- Available in white (2600 K to 10,000 K CCT), royal blue, blue, green, red, amber, red-orange
- Maximum drive current: up to 500 mA
- Low thermal resistance: as low as 10 °C/W
- Wide viewing angle: 110° – 125°
- Unlimited floor life at ≤ 30 °C/85% RH
- Reflow solderable - JEDEC J-STD-020C compatible
- Electrically neutral thermal path
- RoHS- and REACh-compliant
- UL-recognized component (E349212)

TABLE OF CONTENTS

Flux Characteristics.....	2
Flux Characteristics - Color	2
Characteristics	4
Relative Spectral Power Distribution.....	5
Relative Flux vs. Junction Temperature	6
Electrical Characteristics.....	7
Thermal Design	8
Relative Flux vs. Current	10
Typical Spatial Distribution.....	11
Reflow Soldering Characteristics .	12
Notes.....	13
Mechanical Dimensions.....	14
Tape and Reel	15
Packaging.....	16



FLUX CHARACTERISTICS (T_j = 25 °C)

The following table provides several base order codes for XLamp XP-C LEDs. It is important to note that the base order codes listed here are a subset of the total available order codes for the product family. For more order codes, as well as a complete description of the order-code nomenclature, please consult the XP Family Binning and Labeling document.

Color	CCT Range		Base Order Codes Min Luminous Flux @ 350 mA		Order Code
	Min.	Max.	Group	Flux (lm)	
Cool White	5000 K	10,000 K	Q2	87.4	XPCWHT-L1-0000-00A01
			Q3	93.9	XPCWHT-L1-0000-00B01
			Q4	100	XPCWHT-L1-0000-00C01
Neutral White	3700 K	5300 K	P3	73.9	XPCWHT-L1-0000-008E4
			P4	80.6	XPCWHT-L1-0000-009E4
			Q2	87.4	XPCWHT-L1-0000-00AE4
Warm White	2600 K	3700 K	N4	62.0	XPCWHT-L1-0000-006E7
			P2	67.2	XPCWHT-L1-0000-007E7
			P3	73.9	XPCWHT-L1-0000-008E7

Notes:

- Cree maintains a tolerance of ±7% on flux and power measurements, ±0.005 on chromaticity (CC_x, CC_y) measurements and ±2 on CRI measurements.
- Typical CRI for Cool White (5000 K – 10,000 K CCT) is 70.
- Typical CRI for Neutral White (3700 K – 5300 K CCT) is 75.
- Typical CRI for Warm White (2600 K – 3700 K CCT) is 80.

FLUX CHARACTERISTICS (T_j = 25 °C) - COLOR

The following table provides several base order codes for XLamp XP-C LEDs. It is important to note that the base order codes listed here are a subset of the total available order codes for the product family. For more order codes, as well as a complete description of the order-code nomenclature, please consult the XLamp XP Family Binning and Labeling document.

Color	Dominant Wavelength Range				Base Order Codes Min. Radiant Flux @ 350 mA		Calculated Min. Radiant Flux (mW) @ 125 mA*	Order Code
	Min.		Max.		Group	Flux (mW)		
	Group	DWL (nm)	Group	DWL (nm)				
Royal Blue	D3	450	D5	465	12	250	104	XPCROY-L1-0000-00701
					13	300	124	XPCROY-L1-0000-00801
					14	350	145	XPCROY-L1-0000-00901

* Calculated values for reference only

Color	Dominant Wavelength Range				Base Order Codes Min. Luminous Flux @ 350 mA		Calculated Min. Luminous Flux (lm) @ 125 mA*	Order Code
	Min.		Max.		Group	Flux (lm)		
	Group	DWL (nm)	Group	DWL (nm)				
Blue	B3	465	B6	485	J	23.5	10.8	XPCBLU-L1-0000-00W01
					K2	30.6	13.8	XPCBLU-L1-0000-00Y01

Color	Dominant Wavelength Range				Base Order Codes Min. Luminous Flux @ 350 mA		Calculated Min. Luminous Flux (lm) @ 125 mA*	Order Code
	Min.		Max.		Group	Flux (lm)		
	Group	DWL (nm)	Group	DWL (nm)				
Green	G2	520	G4	535	N3	56.8	28.2	XPCGRN-L1-0000-00501
					N4	62	30.8	XPCGRN-L1-0000-00601
					P2	67.2	33.3	XPCGRN-L1-0000-00701
					P3	73.9	36.7	XPCGRN-L1-0000-00801

Color	Dominant Wavelength Range				Base Order Codes Min. Luminous Flux @ 350 mA		Calculated Min. Luminous Flux (lm) @ 125mA*	Order Code
	Min.		Max.		Group	Flux (lm)		
	Group	DWL (nm)	Group	DWL (nm)				
Amber	A2	585	A3	595	M2	39.8	14.9	XPCAMB-L1-0000-00201
					M3	45.7	17.1	XPCAMB-L1-0000-00301
					N2	51.7	19.4	XPCAMB-L1-0000-00401
					N3	56.8	21.3	XPCAMB-L1-0000-00501

Color	Dominant Wavelength Range				Base Order Codes Min. Luminous Flux @ 350 mA		Calculated Min. Luminous Flux (lm) @ 125 mA*	Order Code
	Min.		Max.		Group	Flux (lm)		
	Group	DWL (nm)	Group	DWL (nm)				
Red-Orange	O3	610	O4	620	N2	51.7	19.8	XPCRDO-L1-0000-00401
					N3	56.8	21.7	XPCRDO-L1-0000-00501
					N4	62	23.7	XPCRDO-L1-0000-00601
					P2	67.2	25.7	XPCRDO-L1-0000-00701

* Calculated values for reference only

Color	Dominant Wavelength Range				Base Order Codes Min. Luminous Flux @ 350 mA		Calculated Min. Luminous Flux (lm) @ 125 mA*	Order Code
	Min.		Max.		Group	Flux (lm)		
	Group	DWL (nm)	Group	DWL (nm)				
Red	R2	620	R3	630	M2	39.8	15.2	XPCRED-L1-0000-00201
					M3	45.7	17.5	XPCRED-L1-0000-00301
					N2	51.7	19.7	XPCRED-L1-0000-00401
					N3	56.8	21.7	XPCRED-L1-0000-00501

* Calculated values for reference only

Note: Cree maintains a tolerance of +/- 7% on flux and power measurements.

CHARACTERISTICS

Characteristics	Unit	Minimum	Typical	Maximum
Thermal Resistance, junction to solder point - white, royal blue, blue	°C/W		12	
Thermal Resistance, junction to solder point - green	°C/W		20	
Thermal Resistance, junction to solder point - amber	°C/W		15	
Thermal Resistance, junction to solder point - red, red-orange	°C/W		10	
Viewing Angle (FWHM) - white	degrees		115	
Viewing Angle (FWHM) - royal blue, blue, green, red, red-orange, amber	degrees		125	
Temperature coefficient of voltage - white, blue, royal blue, green	mV/°C		-4.0	
Temperature coefficient of voltage - red-orange, red, amber	mV/°C		-2.0	
ESD Classification (HBM per Mil-Std-883D)			Class 2	
DC Forward Current - white, royal blue, blue, green	mA			500
DC Forward Current - red-orange, red, amber	mA			350
Reverse Voltage	V			5
Forward Voltage (@ 350 mA) - white	V		3.2	3.9
Forward Voltage (@ 350 mA) - royal blue, blue	V		3.3	3.9
Forward voltage (@ 350 mA) - green	V		3.4	3.9
Forward voltage (@ 350 mA) - red-orange, red, amber	V		2.2	2.5
Forward Voltage (@ 125 mA) - royal blue, blue	V		3.1	
Forward Voltage (@ 125 mA) - green	V		3.3	
Forward Voltage (@ 125 mA) - red-orange, red	V		2.0	
Forward Voltage (@ 125 mA) - amber	V		2.1	
Forward voltage (@ 500 mA) - royal blue, blue, white	V		3.5	
Forward Voltage (@ 500 mA) - green	V		3.6	
LED Junction Temperature	°C			150

RELATIVE SPECTRAL POWER DISTRIBUTION

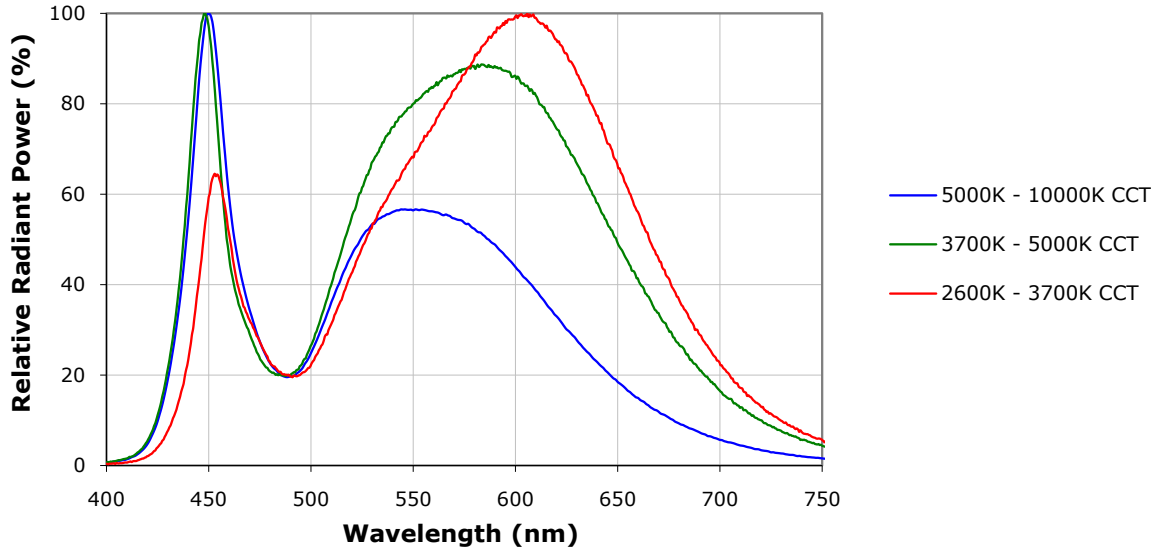

White

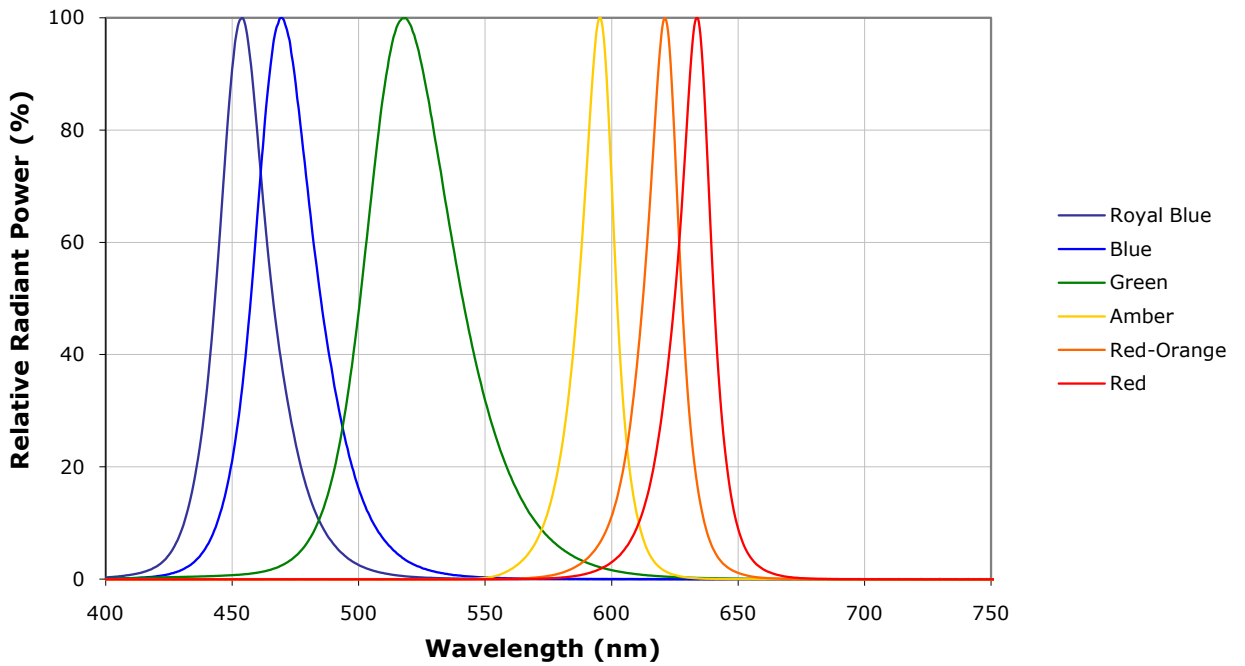

Color

RELATIVE FLUX VS. JUNCTION TEMPERATURE ($I_F = 350 \text{ mA}$)



ELECTRICAL CHARACTERISTICS ($T_j = 25\text{ }^\circ\text{C}$)

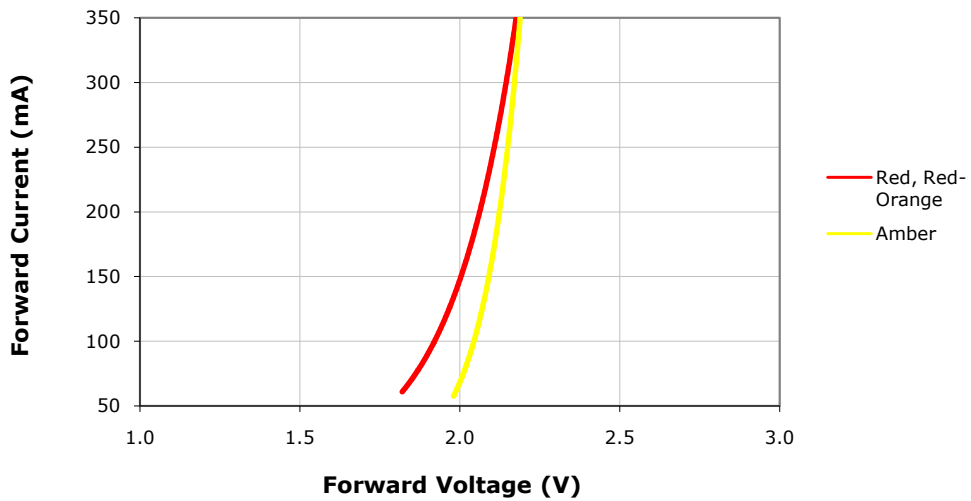

THERMAL DESIGN

The maximum forward current is determined by the thermal resistance between the LED junction and ambient. It is crucial for the end product to be designed in a manner that minimizes the thermal resistance from the solder point to ambient in order to optimize lamp life and optical characteristics.

White, Blue,
Royal Blue

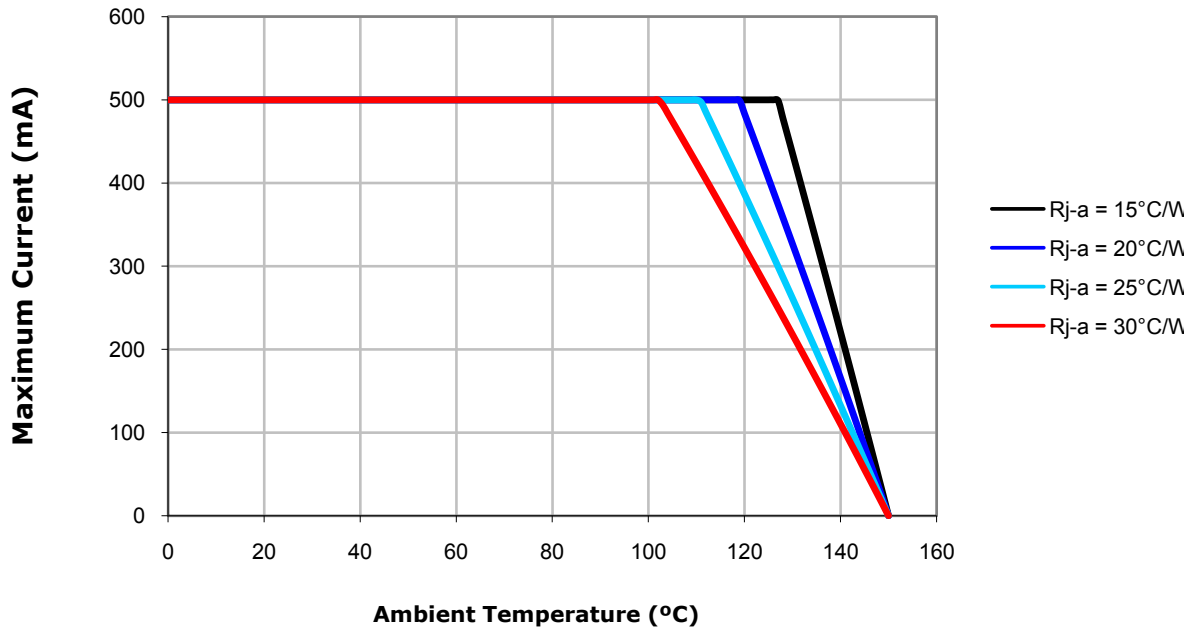

Green

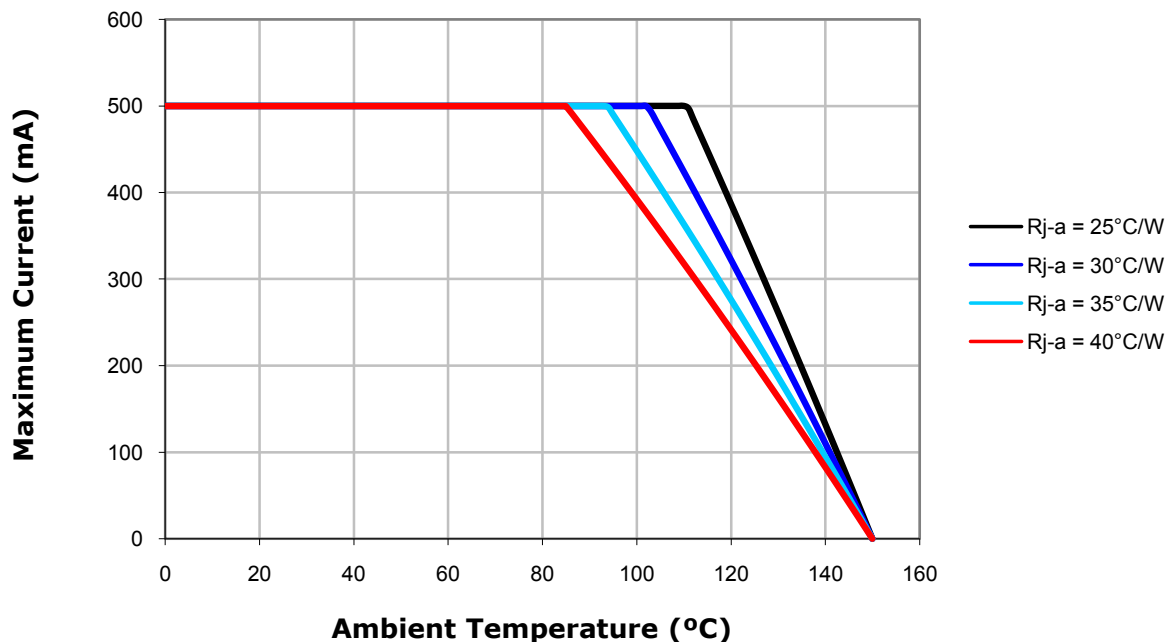

THERMAL DESIGN (CONTINUED)

Amber



Red,
Red-Orange



RELATIVE FLUX VS. CURRENT ($T_j = 25\text{ }^\circ\text{C}$)



TYPICAL SPATIAL DISTRIBUTION



REFLOW SOLDERING CHARACTERISTICS

In testing, Cree has found XLamp XP-C LEDs to be compatible with JEDEC J-STD-020C, using the parameters listed below. As a general guideline, Cree recommends that users follow the recommended soldering profile provided by the manufacturer of solder paste used.

Note that this general guideline may not apply to all PCB designs and configurations of reflow soldering equipment.

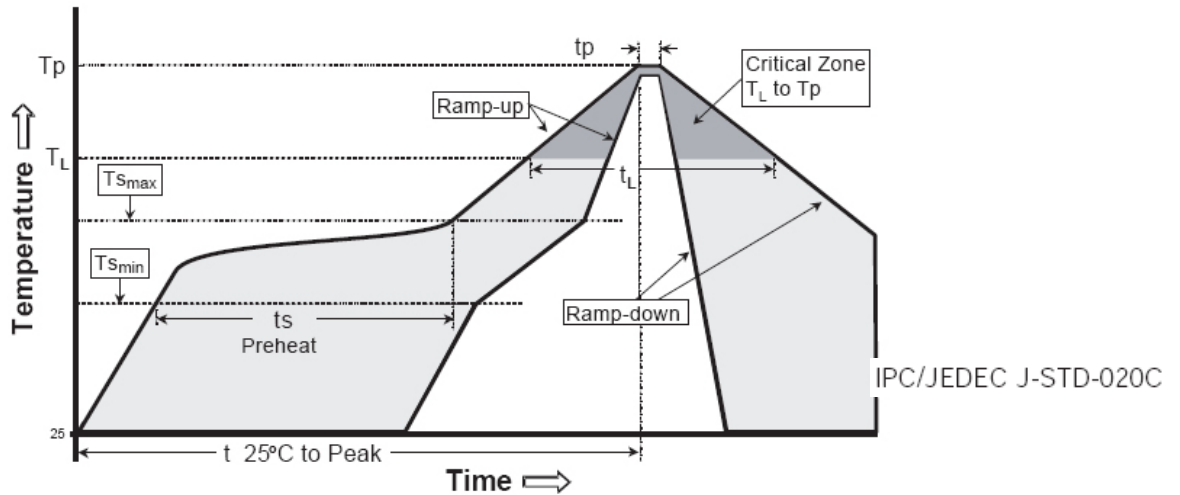

Profile Feature	Lead-Based Solder	Lead-Free Solder
Average Ramp-Up Rate ($T_{s_{max}}$ to T_p)	3 °C/second max.	3 °C/second max.
Preheat: Temperature Min ($T_{s_{min}}$)	100 °C	150 °C
Preheat: Temperature Max ($T_{s_{max}}$)	150 °C	200 °C
Preheat: Time ($t_{s_{min}}$ to $t_{s_{max}}$)	60-120 seconds	60-180 seconds
Time Maintained Above: Temperature (T_l)	183 °C	217 °C
Time Maintained Above: Time (t_l)	60-150 seconds	60-150 seconds
Peak/Classification Temperature (T_p)	215 °C	260 °C
Time Within 5 °C of Actual Peak Temperature (t_p)	10-30 seconds	20-40 seconds
Ramp-Down Rate	6 °C/second max.	6 °C/second max.
Time 25 °C to Peak Temperature	6 minutes max.	8 minutes max.

Note: All temperatures refer to topside of the package, measured on the package body surface.

NOTES

Moisture Sensitivity

In testing, Cree has found XLamp XP-C & XP-E LEDs to have unlimited floor life in conditions ≤ 30 °C/85% relative humidity (RH). Moisture testing included a 168-hour soak at 85 °C/85% RH followed by 3 reflow cycles, with visual and electrical inspections at each stage.

Cree recommends keeping XLamp LEDs in their sealed moisture-barrier packaging until immediately prior to use. Cree also recommends returning any unused LEDs to the resealable moisture-barrier bag and closing the bag immediately after use.

RoHS Compliance

The levels of RoHS restricted materials in this product are below the maximum concentration values (also referred to as the threshold limits) permitted for such substances, or are used in an exempted application, in accordance with EU Directive 2011/65/EC (RoHS2), as amended through June 8, 2011. RoHS Declarations for this product can be obtained from your Cree representative or obtained from the Product Ecology section of www.cree.com.

REACH Compliance

REACH substances of high concern (SVHCs) information is available for this product. Since the European Chemical Agency (ECHA) has published notices of their intent to frequently revise the SVHC listing for the foreseeable future, please contact a Cree representative to insure you get the most up-to-date REACH Declaration. Historical REACH banned substance information (substances restricted or banned in the EU prior to 2010) is also available upon request.

UL Recognized Component

Level 4 enclosure consideration. The LED package or a portion thereof has been investigated as a fire and electrical enclosure per ANSI/UL 8750.

Vision Advisory Claim

WARNING: Do not look at exposed lamp in operation. Eye injury can result. See LED Eye Safety at www.cree.com/xlamp_app_notes/led_eye_safety.

Intellectual Property

For remote phosphor applications, a separate license to certain Cree patents is required.

MECHANICAL DIMENSIONS (T_A = 25°C)

All measurements are ±.13 mm unless otherwise indicated.



Top View



Side View

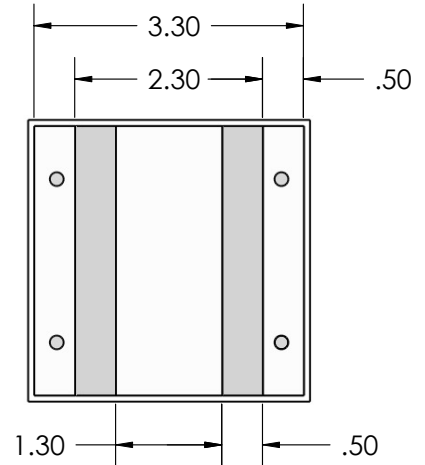

Bottom View



RECOMMENDED PCB SOLDER PAD



**RECOMMENDED STENCIL PATTERN
(HATCHED AREA IS OPENING)**

PACKAGING

Unpackaged Reel

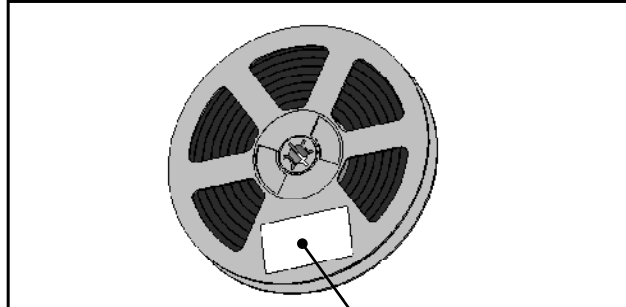

Label with Cree Bin Code, Qty, Reel ID

Packaged Reel



Label with Cree Order Code, Qty, Reel ID, PO #

Label with Cree Bin Code, Qty, Reel ID

Boxed Reel

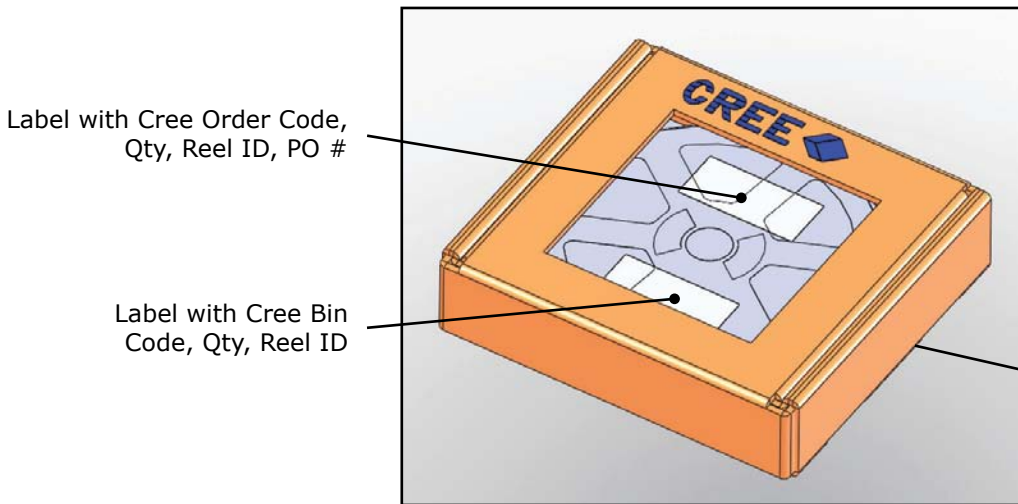

Label with Cree Order Code, Qty, Reel ID, PO #

Label with Cree Bin Code, Qty, Reel ID

Patent Label (on bottom of box)



Стандарт Электрон Связь

Мы молодая и активно развивающаяся компания в области поставок электронных компонентов. Мы поставляем электронные компоненты отечественного и импортного производства напрямую от производителей и с крупнейших складов мира.

Благодаря сотрудничеству с мировыми поставщиками мы осуществляем комплексные и плановые поставки широчайшего спектра электронных компонентов.

Собственная эффективная логистика и склад в обеспечивает надежную поставку продукции в точно указанные сроки по всей России.

Мы осуществляем техническую поддержку нашим клиентам и предпродажную проверку качества продукции. На все поставляемые продукты мы предоставляем гарантию .

Осуществляем поставки продукции под контролем ВП МО РФ на предприятия военно-промышленного комплекса России , а также работаем в рамках 275 ФЗ с открытием отдельных счетов в уполномоченном банке. Система менеджмента качества компании соответствует требованиям ГОСТ ISO 9001.

Минимальные сроки поставки, гибкие цены, неограниченный ассортимент и индивидуальный подход к клиентам являются основой для выстраивания долгосрочного и эффективного сотрудничества с предприятиями радиоэлектронной промышленности, предприятиями ВПК и научно-исследовательскими институтами России.

С нами вы становитесь еще успешнее!

Наши контакты:

Телефон: +7 812 627 14 35

Электронная почта: sales@st-electron.ru

Адрес: 198099, Санкт-Петербург,
Промышленная ул, дом № 19, литера Н,
помещение 100-Н Офис 331