



FWC080 Series

80 Watt ITE Desktop Power Supply

- High Efficiency: Level V
- High Power Density 4.2W/in³
- Lifetime Expectation >5 years
- Hold-up Time >48ms at full load
- Power Factor Correction
- EISA and CEC Compliant
- LED Indicator
- Class I

Overview

Over the later part of 2015, we will be changing the way we sell ITE power supplies thru distribution to no longer include AC cords with the units. During this time of transition you find both versions available for sale. They can be distinguished by the part number, parts ending in -10B will include a cord in the box, parts ending in -10A will not include a cord. If your distributor has not already made a recommendation on a cord, please do not hesitate to ask us for assistance

The FWC080 series is an external, switch mode power supply that offers leading edge converter efficiencies of up to 90% at 115 VAC. This high efficiency results in a compact size, lower internal temperature, and enhanced reliability. The FWC080 offers a power density of 4.2 watts per cubic inch and is ideal for applications requiring high power in a lightweight package. The FWC080 is well suited for IT, data, and telecom equipment and meets IEC 60950-1 standards.

The convection cooled FWC080 series measures 7.09" x 2.27" x 1.52" (180.2mm x 57.5mm x 38.6mm), weighs 1.52 lbs. (0.69kg), comes standard with an LED indicator, and has power factor correction. The 100 watt desktop power supply is available in models ranging from 12VDC to 48VDC. It is comprehensively protected against over-voltage, over-temperature, and short circuit conditions, and its demonstrated mean time between failure exceeds 200,000 hours. Designing with a FWC080 ensures a highly efficient, highly reliable power solution that reduces operating cost and ensures silent, maintenance-free operation.

Elpac Part Number	Output Voltage	Output Current	Peak Current ¹	Total Regulation ²	Typical Efficiency ³
FWC080012A-12A	12.0V	6.6A	8.0A	±5%	88%
FWC080012A-12B	12.0V	6.6A	8.0A	±5%	88%
FWC080015A-12B	15.0V	5.3A	6.4A	±5%	88%
FWC080015A-12A	15.0V	5.3A	6.4A	±5%	88%
FWC080018A-11B	18.0V	4.4A	5.3A	±5%	88%
FWC080018A-11A	18.0V	4.4A	5.3A	±5%	88%
FWC080024A-11A	24.0V	3.3A	4.0A	±5%	89%
FWC080024A-11B	24.0V	3.3A	4.0A	±5%	89%
FWC080048A-11B	48.0V	1.7A	2.0A	±5%	90%
FWC080048A-11A	48.0V	1.7A	2.0A	±5%	90%

Notes

1 Maximum peak load (120W) lasting 500ms with a maximum 10% duty cycle.

2 Includes initial setting, line regulation, load regulation, and thermal drift.

3 Typical at 115VAC (including output cable).

Input	
Input Voltage	85 - 264VAC 100 - 240VAC Nominal
Input Frequency	47 - 63Hz
Input Current	<1.0A rms
Inrush Current	<37A at 230VAC cold start
Power Factor	>0.97
Zero Load Power Consumption	<0.5W
Touch Leakage Current	<150µA @ 132VAC @ 60Hz <200µA @ 264VAC @ 60Hz

Output

Output Voltage	See Table
Total Regulation	+/-5%
Minimum Load	No minimum load required
Start-Up Delay	~1s
Hold-Up Time	>48ms at any input voltage
Ripple & Noise	<1% pk-pk *
Over Voltage Protection	110-135%
Over Temperature Protection	Active - Recoverable; plus Passive - Non Recoverable
Over Current Protection	120 - 180%
Short Circuit Protection	shutdown, auto-restart (hiccup mode)

Notes

* Ripple and noise measured with 20MHz bandwidth; 10µF tantalum capacitor in parallel with a 0.1µF ceramic capacitor.

General

Efficiency	Avg Efficiency 88.8% @ 115VAC; 89.8% @ 230VAC
MTBF	min. 200,000 hours demonstrated
Size	7.09" x 2.27" x 1.52" 180.2mm x 57.5mm x 38.6mm
Weight	1.52 lbs (0.69 kg)
Power Density	4.2W/in ³

Environmental

Operating Temperature	0 – 60°C (Full load to 40°C, derate linearly to 50% load at 60°C)
Storage Temperature	-40°C to +85°C
Relative Humidity	5-95%, non-condensing
Cooling	Natural Convection
Vibration	All units production tested to 19.6m/s ²

EMC & Safety

Emissions	FCC class B, CISPR22 class B EN61000-3-2, -3
Immunity	EN61000-4-2, -3, -4, -5, -6, -8, -11
Certified by TUV to the following:	cTUVus
	UL 60950-1
	CAN/CSA-22.2 No.60950-1
	CB per IEC60950-1
	CE marked to LVD & EMC

Input Configuration

Standard Input Cable	Not Provided
Connection on Power Supply Body	IEC 320 C14 Receptacle

Output Configuration (18V, 24V, 48V)

Standard Output Cable	6 ft.
Cord Size	4x18awg
Connector (PSU side)	Switchcraft DIN-5, P/N 05GM5MX for 18V, 24V & 48V
Mating Connector	Switchcraft 57GB5FX (5 pin) or equivalent

Output Configuration (12V, 15V)

Standard Output Cable	4 ft.
Cord Size	4x16awg
Connector (PSU side)	Switchcraft DIN-8,P/N 15BL8M (male pins)
Mating Connector	Switchcraft 62GB8FX (8 pin) or equivalent

Output Pin Assignments



Pin 1	+V1
Pin 2	+V1
Pin 3	Return
Pin 4	+V1
Pin 5	Return
Pin 6	+V1
Pin 7	Return
Pin 8	Return

Output Pin Assignments

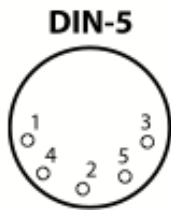

Pin 1	Return
Pin 2	Return
Pin 3	+V1
Pin 4	Return
Pin 5	+V1

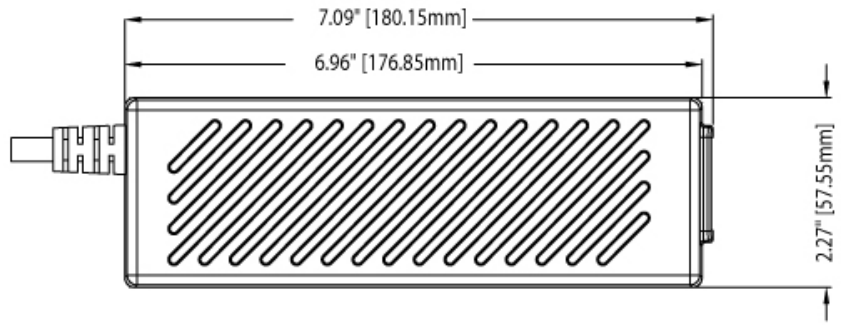
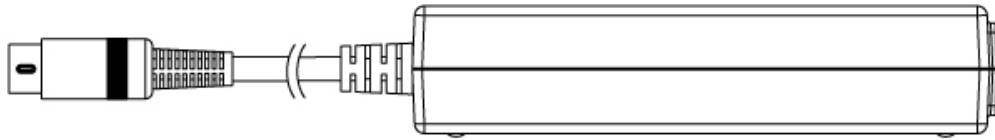



Стандарт Электрон Связь

Мы молодая и активно развивающаяся компания в области поставок электронных компонентов. Мы поставляем электронные компоненты отечественного и импортного производства напрямую от производителей и с крупнейших складов мира.

Благодаря сотрудничеству с мировыми поставщиками мы осуществляем комплексные и плановые поставки широчайшего спектра электронных компонентов.

Собственная эффективная логистика и склад в обеспечивает надежную поставку продукции в точно указанные сроки по всей России.

Мы осуществляем техническую поддержку нашим клиентам и предпродажную проверку качества продукции. На все поставляемые продукты мы предоставляем гарантию .

Осуществляем поставки продукции под контролем ВП МО РФ на предприятия военно-промышленного комплекса России , а также работаем в рамках 275 ФЗ с открытием отдельных счетов в уполномоченном банке. Система менеджмента качества компании соответствует требованиям ГОСТ ISO 9001.

Минимальные сроки поставки, гибкие цены, неограниченный ассортимент и индивидуальный подход к клиентам являются основой для выстраивания долгосрочного и эффективного сотрудничества с предприятиями радиоэлектронной промышленности, предприятиями ВПК и научно-исследовательскими институтами России.

С нами вы становитесь еще успешнее!

Наши контакты:

Телефон: +7 812 627 14 35

Электронная почта: sales@st-electron.ru

Адрес: 198099, Санкт-Петербург,
Промышленная ул, дом № 19, литера Н,
помещение 100-Н Офис 331