



General Description

The MIC2040 and MIC2041 are high side MOSFET switches optimized for general purpose power distribution applications that require circuit protection. The devices switch up to 5.5V and as low as 0.8V while offering both programmable current limiting and thermal shutdown to protect the device and the load. A fault status output is provided in order to detect overcurrent and thermal shutdown fault conditions. Both devices employ soft start circuitry to minimize the inrush current in applications that employ highly capacitive loads. Additionally, the MIC2040/41 is suited for multi-port USB applications to satisfy upstream/downstream power requirements.

The MIC2041 features a auto-reset circuit breaker mode that latches the output off upon detecting an overcurrent condition lasting more than 28ms. The output is reset by removing or reducing the load.

Data sheets and support documentation can be found on Micrel's web site at www.micrel.com.

Features

- 75mΩ max. on-resistance
- 0.8V to 5.5V operating range
- Adjustable current limit
- Up to 1.5A continuous output current
- Short circuit protection with thermal shutdown
- Circuit breaker mode (MIC2041)
- Fault status flag
- Undervoltage lockout
- Output MOSFET reverse current flow block when disabled
- Very fast reaction to short-circuits
- Low quiescent current

Applications

- Docking stations
- Notebook PCs
- PDAs
- Board hot swap
- RAID controllers
- USB peripherals
- ACPI power distribution

Ordering Information

Part Number		Enable	Circuit Breaker	Package
Standard	Pb-Free			
MIC2040-1BMM	MIC2040-1YMM	Active-High		10-Pin MSOP
MIC2040-2BMM	MIC2040-2YMM	Active-Low		10-Pin MSOP
MIC2041-1BMM	MIC2041-1YMM	Active-High	X	10-Pin MSOP
MIC2041-2BMM	MIC2041-2YMM	Active-Low	X	10-Pin MSOP

Typical Application

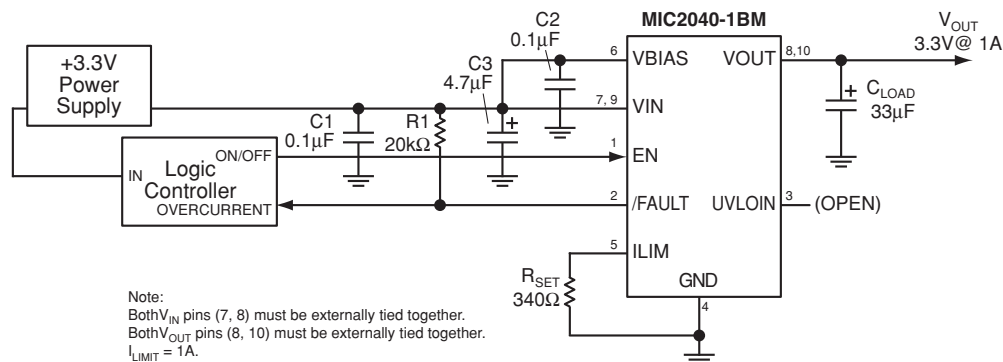

Pin Configuration

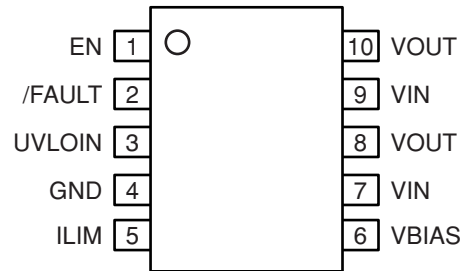

MIC2040/MIC2041
10-Pin MSOP (MM)

Pin Description

Pin Number	Pin Name	Pin Function
1	EN	Switch Enable Input: Gate control pin of the output MOSFET available as an active high (–1) or active low (–2) input signal.
2	/FAULT	Fault Status Output: Open drain N-Channel device, active low. This pin indicates an overcurrent, or thermal shutdown condition. For an overcurrent event, /FAULT is asserted if the duration of the overcurrent condition lasts longer than 28ms.
4	GND	Ground Connection: Tie to analog ground.
5	ILIM	Current Limit Set: A resistor, R_{SET} , connected to this pin sets the current limit threshold as CLF/R_{SET} , where CLF is the current limit factor specified in the electrical characteristics table. For the MIC2040/41, the continuous output current range is 0.25A to 1.5A.
7, 9	VIN	Switch Input Supply: The drain of the output MOSFET. The range of input for the switch is 0.8V to 5.5V. These pins must be externally connected together.
8, 10	VOUT	Switch Output: The source of the output MOSFET. These pins must be externally connected together.
6	VBIAS	Bias Supply Input: This input pin supplies bias to operate the switch with range from 1.6V to 5.5V. When switching voltage (V_{IN}) is between 1.6V to 5.5V and the use of a single supply is desired, connect VBIAS to VIN externally.
3	UVLOIN	Undervoltage Lockout Adjust Input: With this pin left open, the UVLO threshold is internally set to 1.45V. When the switching voltage (V_{IN}) is at or below 1.6V, connecting an external resistive divider to this input will lower the UVLO threshold. The total resistance must be less than 200k Ω . See “Applications Information” for further detail.

Absolute Maximum Ratings⁽¹⁾

V_{IN} and V_{BIAS}	6V
/FAULT, PWRGD Output Voltage	6V
/FAULT, PWRGD Output Current	25mA
Junction Temperature Range	Internally Limited
ESD Rating ⁽³⁾	
Human Body Model	2kV
Machine Model	200V

Operating Ratings⁽²⁾

Supply Voltage	
V_{IN}	0.8V to 5.5V
V_{BIAS}	1.6V to 5.5V
Continuous Output Current	0.25A to 1.5A
Ambient Temperature (T_A)	-40°C to 85°C
Package Thermal Resistance ($R_{\theta(J-A)}$)	
MSOP	160°C/W

Electrical Characteristics⁽⁴⁾

$V_{IN} = V_{BIAS} = 5V$. $T_A = 25^\circ\text{C}$ unless specified otherwise. **Bold** indicates -40°C to +85°C.

Symbol	Parameter	Condition	Min	Typ	Max	Units
V_{IN}	Switch Input Voltage	$V_{IN} \leq V_{BIAS}$	0.8		5.5	V
V_{BIAS}	Bias Supply Voltage		1.6		5.5	V
I_{BIAS}	VBIAS Supply Current - Switch OFF VBIAS Supply Current - Switch ON Note 5	No load No load		0.1 250	5 400	μA μA
V_{EN}	Enable Input Voltage	$V_{IL(max)}$		2.4	1.5	V
		$V_{IH(min)}$	3.5	2.5		V
V_{ENHYS}	Enable Input Threshold Hysteresis			100		mV
I_{EN}	Enable Input Current	$V_{EN} = 0V$ to 5.5V	-1	.01	1	μA
$R_{DS(ON)}$	Switch Resistance	$V_{IN} = V_{BIAS} = 3V, 5V$ $I_{OUT} = 500\text{mA}$		50	75	m Ω
I_{LEAK}	Output Leakage Current	Output off			10	μA
CLF	Current Limit Factor ⁽⁶⁾	$V_{IN} = 3V, 5V$; $0.5V \leq V_{OUT} < 0.5V_{IN}$ $0.25A \leq I_{OUT} \leq 1.5A$	280	340	400	A $\cdot\Omega$
V_{LATCH}	Output Reset Threshold	$V_{IN} = 0.8V$ to 5.5V V_{OUT} rising (MIC2041)		$V_{IN} - 0.2$		V
I_{LATCH}	Latched Output Off Current	Output latched off (MIC2041)	1	3	5	mA
V_{OL}	Output low voltage (/FAULT)	I_{OL} (/FAULT) = 15mA			0.4	V
I_{OFF}	/FAULT Off Current	$V_{FAULT} = 5V$			1	μA
V_{UV}	Undervoltage Lockout Threshold	V_{IN} rising	1.30	1.45	1.58	V
		V_{IN} falling	1.20	1.35	1.50	V
V_{UVHYS}	Undervoltage Lockout Threshold Hysteresis			100		mV
V_{UVINTH}	UVLO Adjust Pin Threshold Voltage	V_{IN} rising	200	220	240	mV
		V_{IN} falling	180	200	220	mV
$V_{UVINHYS}$	UVLO Adjust Pin Threshold Hysteresis			20		mV
	Overtemperature Threshold	T_J increasing		140		°C
		T_J decreasing		120		°C

Notes:

- Exceeding the absolute maximum rating may damage the device.
- The device is not guaranteed to function outside its operating rating.
- Devices are ESD sensitive. Handling precautions recommended. Human body model, 1.5k in series with 100pF.
- Specification for packaged product only.
- OFF is $V_{EN} < 1.0V$ for MIC2040/MIC2041-1 and $V_{EN} > 4.0V$ for MIC2040/MIC2041-2. ON is $V_{EN} > 4.0V$ for MIC2040/MIC2041-1 and $V_{EN} < 1.0V$ for MIC2040/MIC2041-2.
- The current limit is determined as follows: $I_{LIM} = CLF/R_{SET}$.

Electrical Characteristics⁽⁷⁾

Symbol	Parameter	Condition	Min	Typ	Max	Units
t_{FLAG}	Flag Response Delay	$V_{IN} = V_{BIAS} = 3V, 5V$	21	28	35	ms
t_{ON}	Output Turn-on Delay,	$R_{LOAD} = 10\Omega, C_{LOAD} = 1\mu F$	400	600	800	μs
t_R	Output turn-on Rise Time	$R_{LOAD} = 10\Omega, C_{LOAD} = 1\mu F$	0.5	1	1.5	ms
t_{OFF}	Output Turn-off Delay	$R_{LOAD} = 10\Omega, C_{LOAD} = 1\mu F$		1	5	μs
t_F	Output Turn-off Fall Time	$R_{LOAD} = 10\Omega, C_{LOAD} = 1\mu F$		24		μs

Note:

7. Specification for packaged product only.

Timing Diagrams

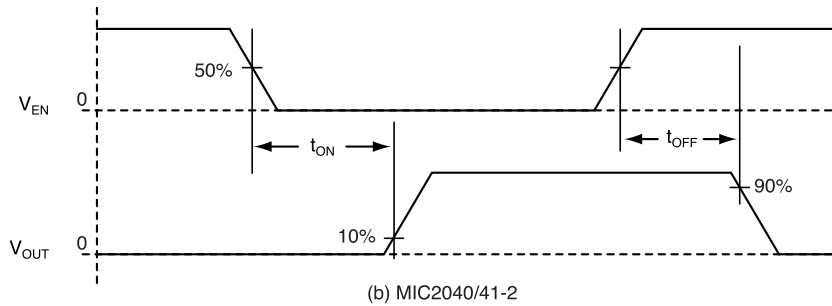
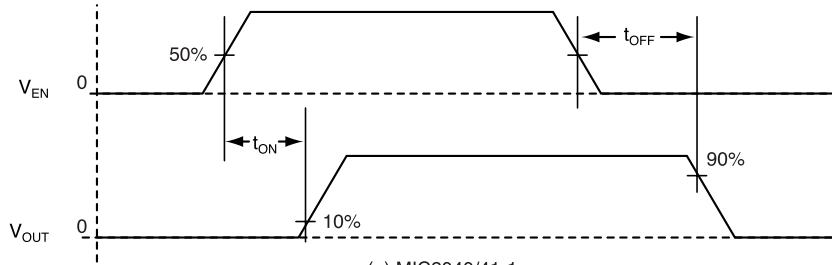
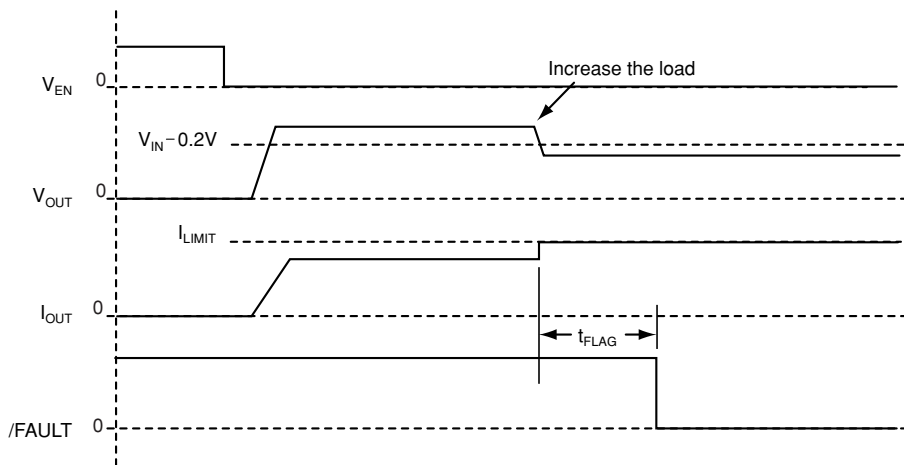
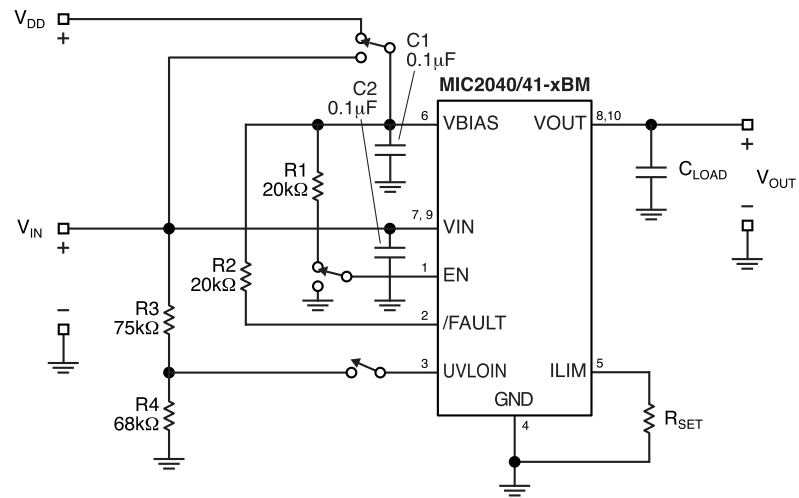

Figure 1. Turn-On/Turn-Off Delay



Test Circuit



Typical Characteristics

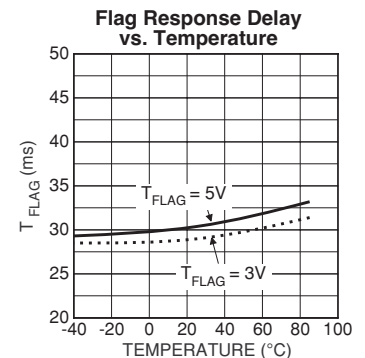
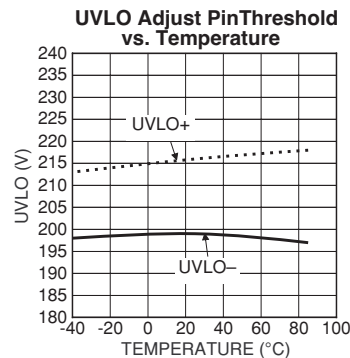
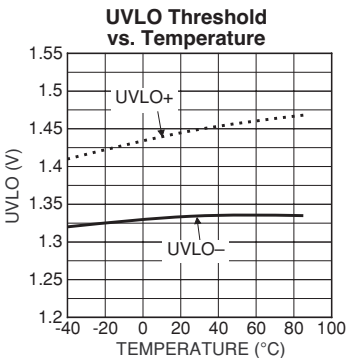
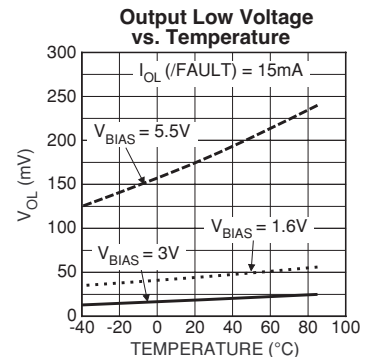
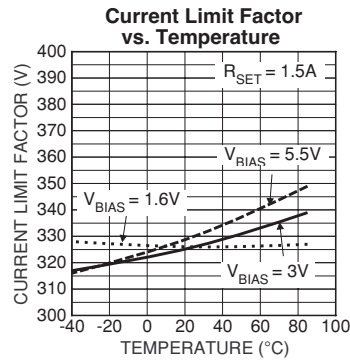
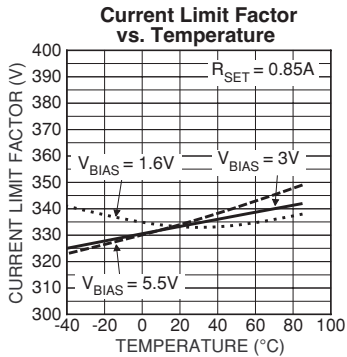
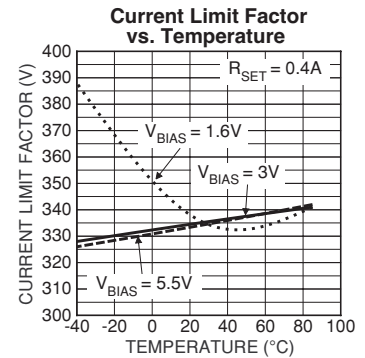
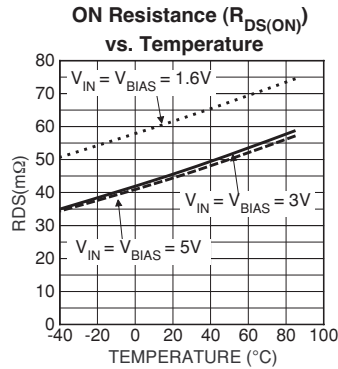
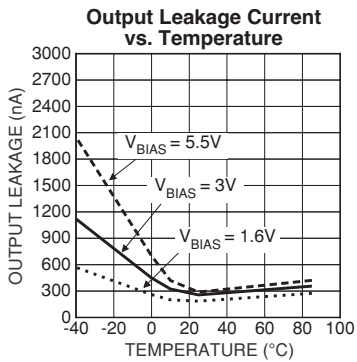
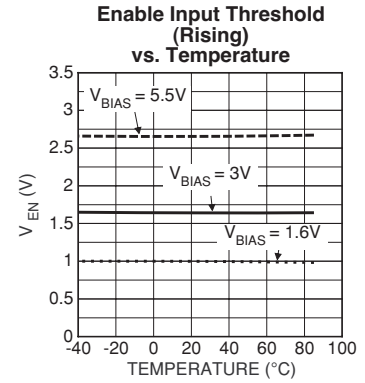
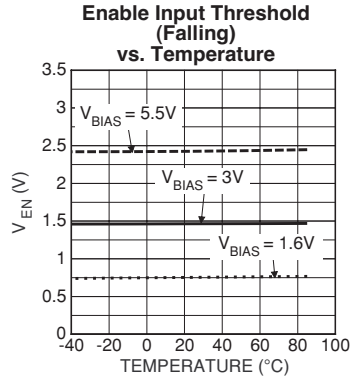
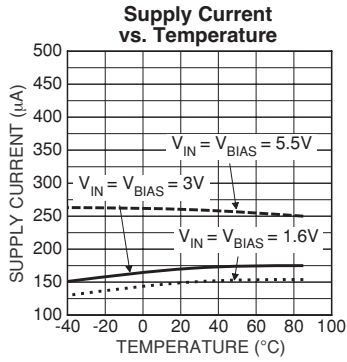

Typical Characteristics (continued)

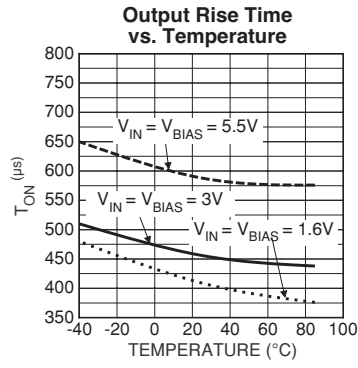
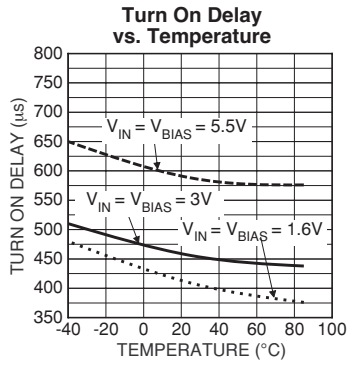

Functional Diagram

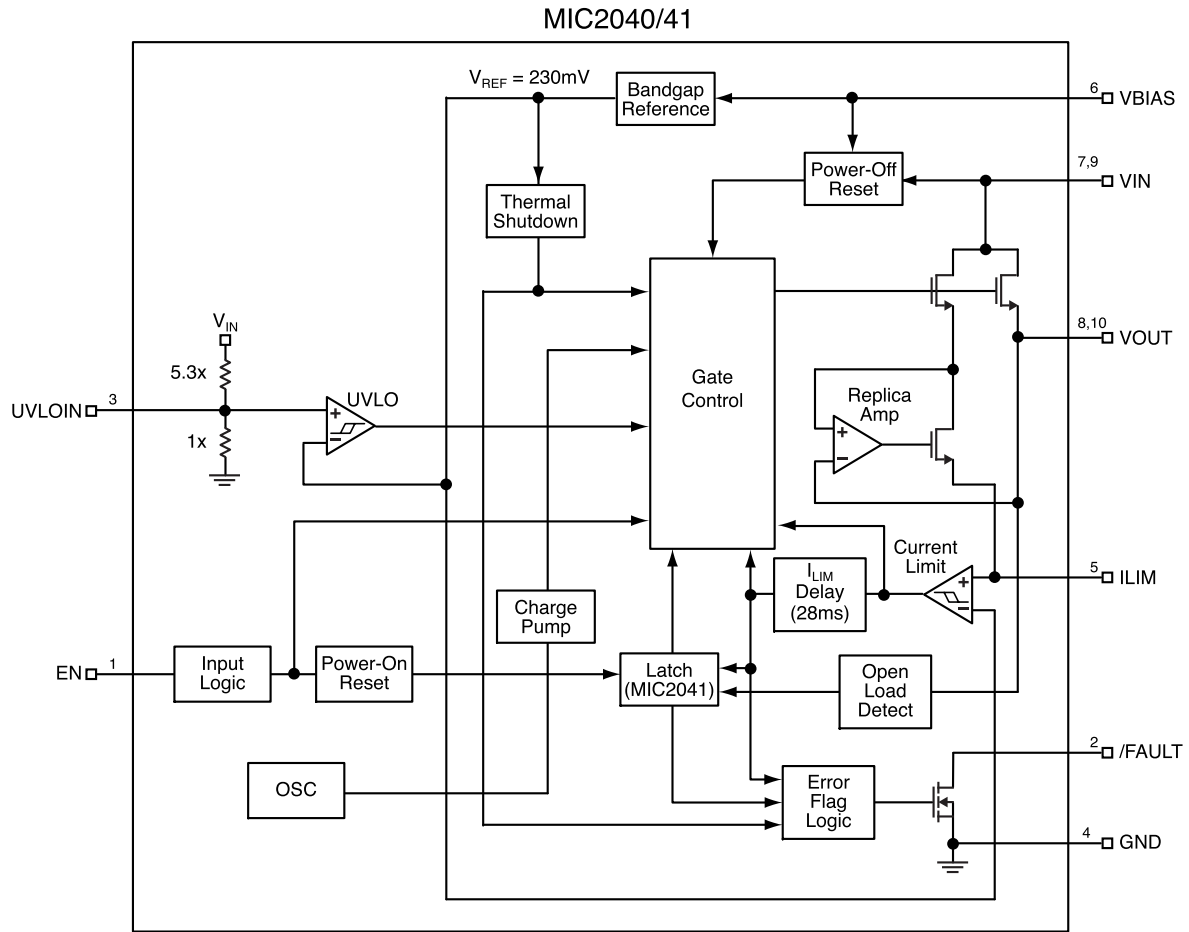

Functional Characteristics

Turn-On Response

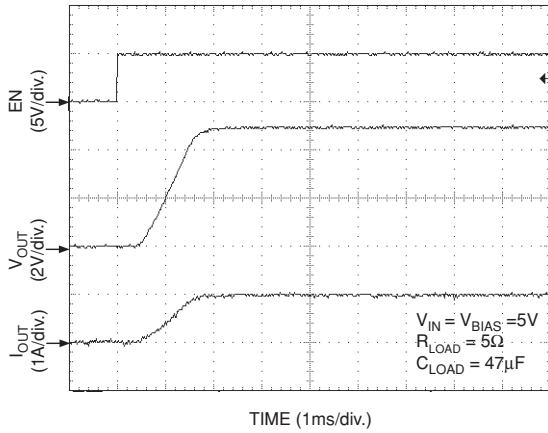

Turn-Off Response

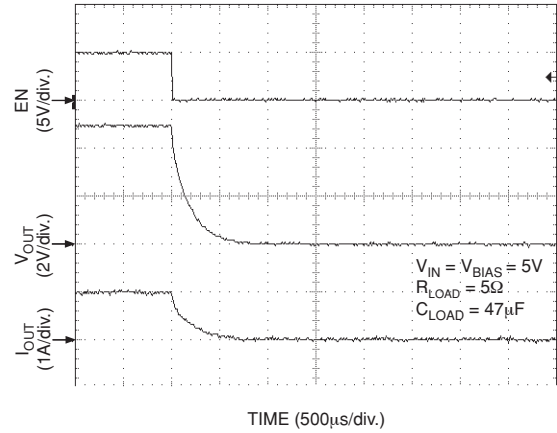

Latched Output - MIC2041

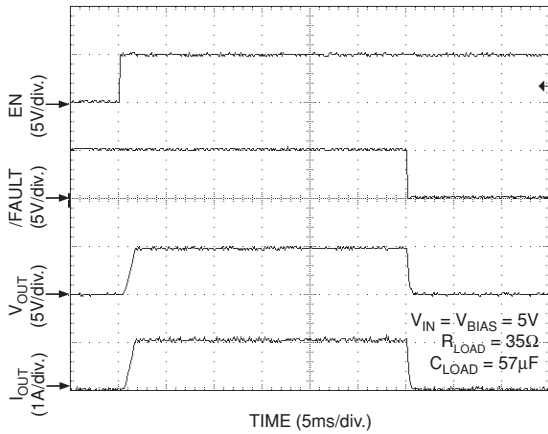

Latched Output Reset - MIC2041

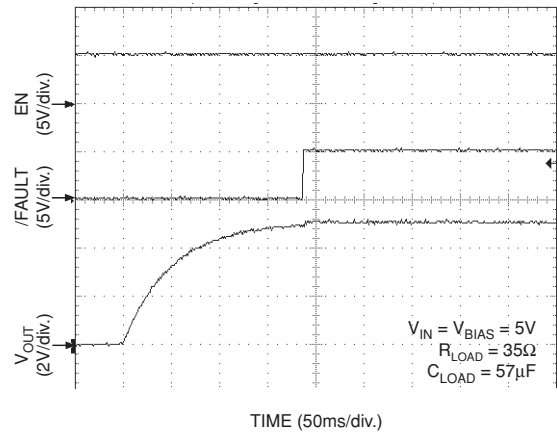

Current-Limit Response

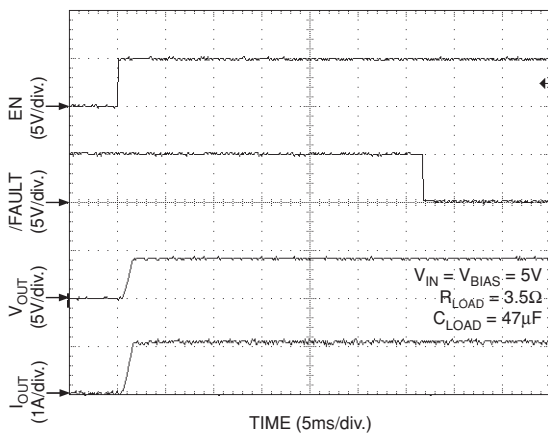

UVLO Response

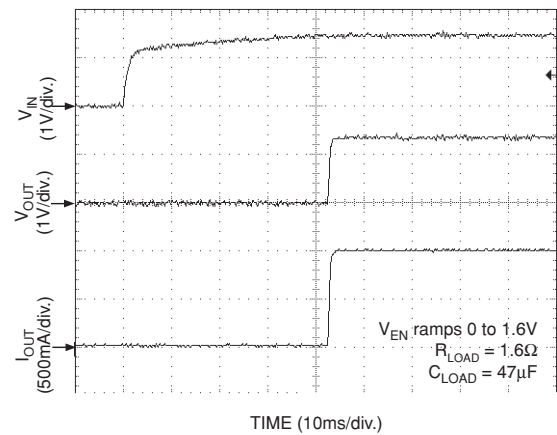

Thermal Shutdown Response

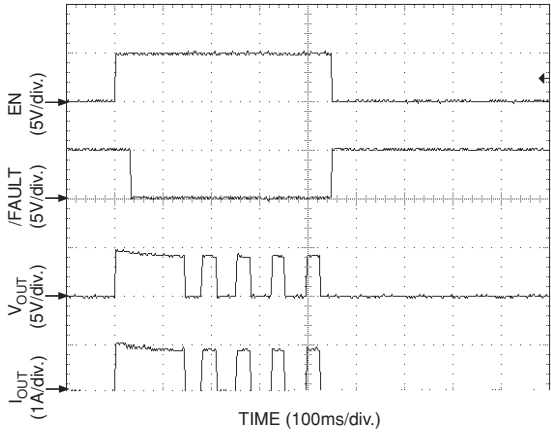

Functional Description

The MIC2040 and MIC2041 are high-side N-Channel switches equipped with programmable current limit up to 1.5A for use in general purpose power distribution applications. The switches, available with active-high or active-low enable inputs, operate down to 0.8V and provide circuit protection via thermal shutdown and an optional output latch during overcurrent conditions.

Input and Output

VBIAS supplies power to the internal circuitry of the switch and must be present for the switch to operate. VIN is connected to the drain of the output MOSFET and sources power to the switched load. VIN must be less than or equal to VBIAS. VOUT is the source terminal of the output MOSFET and attaches to the load. In a typical circuit, current flows from VIN to VOUT toward the load. If VOUT is greater than VIN, current will flow from VOUT to VIN since the switch is bi-directional when the device is enabled. When disabled (OFF), the switch will block current flow from either direction.

Enable Input

Enable, the ON/OFF control for the output switch, is a digital input available as an active-high (+1) or active-low (-2) signal. The EN pin, referenced to approximately $0.5 \times VBIAS$, must be driven to a clearly defined logic high or logic low. Failure to observe this requirement, or allowing EN to float, will cause the MIC2040/41 to exhibit unpredictable behavior. EN should not be allowed to go negative with respect to ground, nor allowed to exceed VBIAS. Failure to adhere to these conditions may result in damage to the device.

Undervoltage Lockout

When the switch is enabled, undervoltage lockout (UVLO) monitors the input voltage, VIN, and prevents the output MOSFET from turning on until VIN exceeds a predetermined level, nominally set at 1.45V. The UVLO threshold is adjustable and can be varied by applying an external resistor divider to the UVLOIN pin from VIN to GND. The resistive divider network is required when the input voltage is below 1.5V. The UVLO threshold is internally preset to 1.45V if the UVLOIN pin is left open. See "Applications Information."

Programmable Current Limit

The MIC2040/41 is designed to prevent damage to the external load by limiting the maximum amount of current it can draw. The current limit is programmed by an external resistor (R_{SET}) connected from ILIM to ground and becomes active when the output voltage is at least 200mV below the voltage at the input to the device. The limiting current value is defined by the current limit factor (CLF) divided by R_{SET} , and the MIC2040/41 will limit from 0.25A to 1.5A with a set point accuracy of $\pm 18\%$. In programming the nominal current limit, the value of R_{SET} is determined using the following equation:

$$R_{SET} = \frac{CLF}{I_{LIM}} = \frac{(340A \times \Omega)}{I_{LIM}} \quad (1)$$

And given the $\pm 18\%$ tolerance of the current limit factor (CLF), the external resistor is bound by:

$$187\Omega \leq R_{SET} \leq 1.6k\Omega \quad (2)$$

The graph below (Figure 3) displays the current limit factor characteristic over the full temperature and voltage range indicated on the graph. This curve can be used as a point of reference in determining the maximum variation in the device's current limit over the full temperature range. For example: With $V_{IN} = V_{BIAS} = 3.0V$ and a nominal 1A current limit ($R_{SET} = 340\Omega$), the low and high current limit settings for the MIC2040/41 would be approximately 0.82A and 1.18A, respectively, as shown on the graph using the 340 Ω reference.

The MIC2041 is equipped with an internal circuit breaker for overcurrent protection. During an overcurrent event which exceeds the flag delay, the /FAULT output is asserted and the MIC2041 latches the output off. Once the overcurrent load is removed, the output automatically resets.

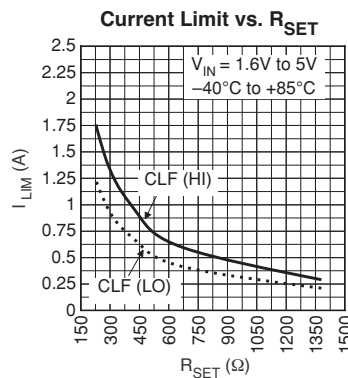

Figure 3. Current Limit Factor

/FAULT

The /FAULT signal is an N-Channel, open-drain MOSFET output. An external pull-up resistor tied to a maximum 6V rail is required for the /FAULT pin. The /FAULT pin is asserted (active-low) when either an overcurrent or thermal shutdown condition occurs. During a hot insert of a PCB or when turning on into a highly capacitive load, the resulting high transient inrush current may exceed the current limit threshold of the MIC2040/41. In the case where an overcurrent condition occurs, /FAULT will assert only after the flag delay time has elapsed, typically 28ms. This ensures that /FAULT is asserted only upon valid overcurrent conditions and that nuisance error reporting is prevented.

Thermal Shutdown

For the MIC2040, thermal shutdown is employed to protect the device from damage should the die temperature exceed safe margins due to a short circuit or an excessive load. Thermal shutdown shuts off the output MOSFET and asserts the /FAULT output if the die temperature exceeds 140°C. The MIC2040 automatically resets its output and resumes supplying current to the load when the die temperature drops to 120°C. If the fault is still present, the MIC2040 will quickly reheat and shut down again. This process of turning ON-OFF-ON is called thermal cycling and will continue as long as the power switch is enabled while the fault or excessive load is present.

Depending on PCB layout (including thermal considerations such as heat sinking), package, and ambient temperature, it may take several hundred milliseconds from the incidence of the fault to the output MOSFET being shut off.

Circuit Breaker Function (MIC2041)

The MIC2041 is designed to shut off all power to the load when a fault condition occurs, just as a circuit breaker would do. A fault condition is deemed to be anytime the output current exceeds the current limit for more than the flag delay period, nominally 28ms. Once the output shuts off, it remains off until either the fault load is removed from VOUT or the EN input is cycled ON-OFF-ON. If the fault is still present after EN has been cycled, the MIC2041 will again shut off all power to the load after 28ms. Once the fault has been removed, then normal operation will resume.

Open Load Detection

The MIC2041 will automatically reset its output when the fault load is cleared. This is accomplished by applying a small current to VOUT and watching for the voltage at VOUT to rise to within 200mV of VIN. This current is supplied by an internal resistor connected to VIN and is connected to VOUT when MIC2041 latches off.

Applications Information

Input and Output

Supply Bypass Filtering

The need for input supply bypass is brought about due to several factors, most notably the input/output inductance along the power path, operating current and current limit, and output capacitance. A 0.1 μ F to 0.47 μ F bypass capacitor positioned very close to the VIN pin to GND of the device is strongly recommended to filter high frequency oscillations due to inductance. Also, a sufficient bypass capacitor positioned close to the input source to the switch is strongly advised in order to suppress supply transient spikes and to limit input voltage droop. Inrush current increases with larger output capacitance, thus the minimum value of this capacitor will require experimental determination for the intended application and design. A good starting point is a capacitor between 4.7 μ F to 15 μ F. Without these bypass capacitors, an extreme overload condition such as a short circuit, or a large capacitive load, may cause either the input supply to exceed the maximum rating of 6V and possibly cause damage to the internal control circuitry or allow the input supply to droop and fall out of regulation and/or below the minimum operating voltage of the device.

Output Capacitance

When the MIC2040 die exceeds the overtemperature threshold of approximately 140°C, the device can enter into a thermal shutdown mode if the die temperature falls below 120°C and then rises above 140°C in a continuous cycle. With the V_{OUT} and /FAULT outputs cycling on and off, the MIC2040 will reset the /FAULT while in an overtemperature fault condition if the output voltage is allowed to swing below ground. The inductance present at the output must be neutralized by capacitance in order to ensure that the output does not fall below ground. In order to counter the board parasitic inductance and the inductance of relatively short-length (<1 ft., 16 - 20 gauge wire), a minimum output capacitance of 22 μ F is strongly recommended and should be placed close to the V_{OUT} pin of the MIC2040. For applications that use more than a foot of cable, an additional 10 μ F/ft. is recommended.

Reverse Current Block

The MIC2040/41 provides reverse current flow block through the output MOSFET if the voltage at V_{OUT} is greater than V_{IN} when the device is disabled. The VBIAS supply has a limited reverse current flow if the voltage at V_{OUT} is pulled above VBIAS when the device is disabled. The reverse current for VBIAS can be completely blocked by inserting a Schottky diode from the VBIAS pin (cathode) to the supply (anode). However, the minimum voltage of 1.6V must be supplied to VBIAS after accounting for the voltage drop across the diode.

UVLO Threshold Setting With Low Input Voltages

When the switching voltage is below 1.6V, the device's standard UVLO threshold (1.45V nominal) will hinder the output MOSFET in switching V_{IN} to V_{OUT}. In this case, the use of the UVLOIN pin is required to override the standard UVLO threshold and set a new, lower threshold for the lower input operating voltages. An external resistive divider network connected at the UVLOIN pin is used to set the new threshold. Due to the ratio of the internal components, the total series resistance of the external resistive divider should not exceed 200k Ω . The circuit shown in Figure 4 illustrates an application that switches 0.8V while the device is powered from a separate 2.5V power supply. The UVLO threshold is set by the following equation.

$$V_{UVTH} = 0.23V \times \left(1 + \frac{R2}{R3}\right) \quad (3)$$

In substituting the resistor values from Figure 4, the resulting UVLO threshold (V_{UVTH}) is calculated as 0.6V for this 0.8V switching application. When using the UVLOIN pin to set a new UVLO threshold, an optional 0.1 μ F to 1.0 μ F capacitor from UVLOIN to GND may be used as a glitch filter in order to avoid nuisance tripping of the UVLO threshold. If the UVLOIN pin is not in use, this pin should be left open (floating). The use of a pull-down resistor to ground will offset the ratio of the internal resistive divider to this pin resulting in a shift in the UVLO threshold. To bypass (disable) UVLO, connect the UVLOIN pin directly to the VIN pin of the MIC2040/41.

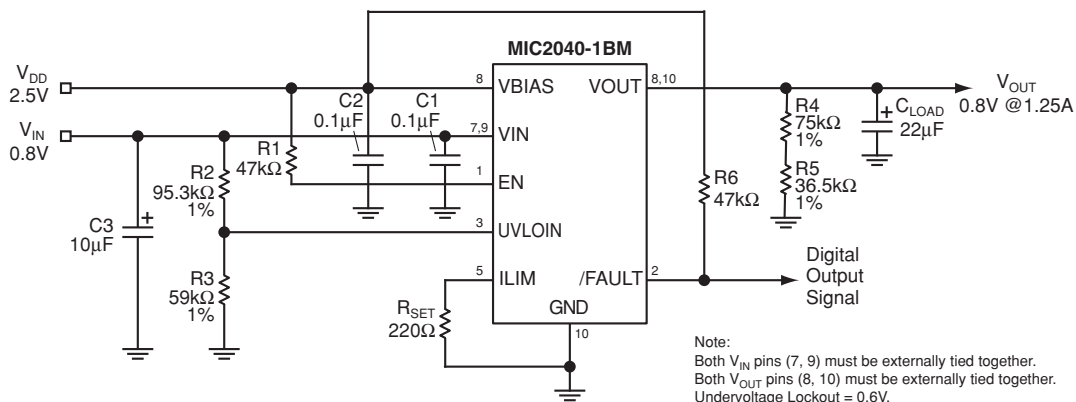
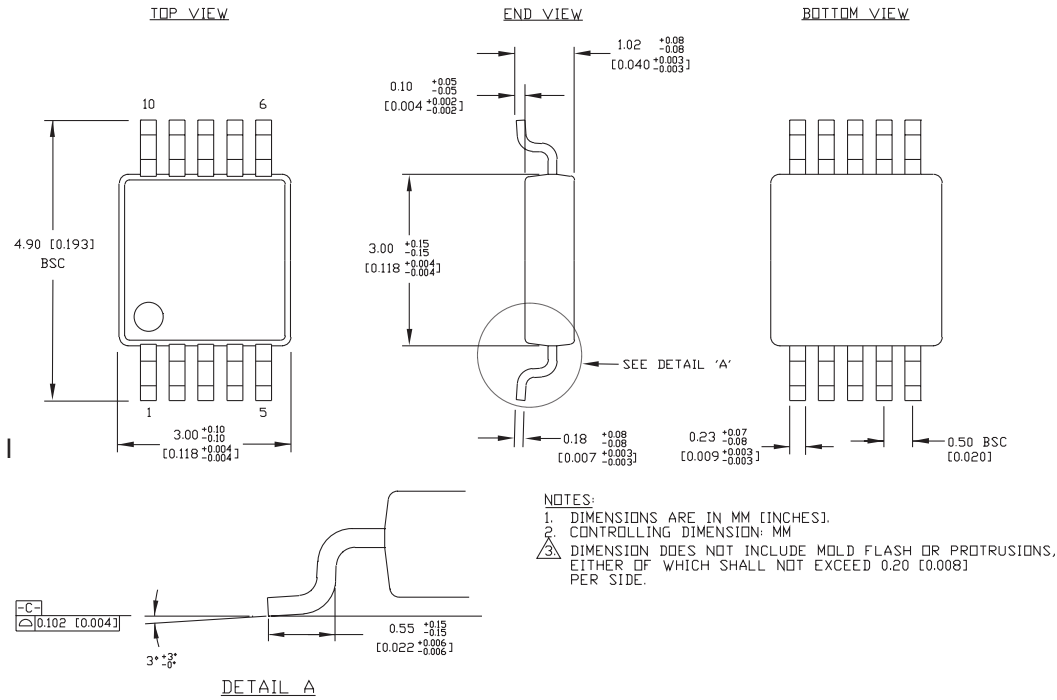

Figure 4. Lower UVLO Setting

Package Information



Rev. 00

10-Pin MSOP (MM)

MICREL, INC. 1849 FORTUNE DRIVE SAN JOSE, CA 95131 USA

TEL + 1 (408) 944-0800 FAX + 1 (408) 944-0970 WEB <http://www.micrel.com>

The information furnished by Micrel in this datasheet is believed to be accurate and reliable. However, no responsibility is assumed by Micrel for its use. Micrel reserves the right to change circuitry and specifications at any time without notification to the customer.

Micrel Products are not designed or authorized for use as components in life support appliances, devices or systems where malfunction of a product can reasonably be expected to result in personal injury. Life support devices or systems are devices or systems that (a) are intended for surgical implant into the body or (b) support or sustain life, and whose failure to perform can be reasonably expected to result in a significant injury to the user. A Purchaser's use or sale of Micrel Products for use in life support appliances, devices or systems is at Purchaser's own risk and Purchaser agrees to fully indemnify Micrel for any damages resulting from such use or sale.

© 2003 Micrel, Incorporated.



Стандарт Электрон Связь

Мы молодая и активно развивающаяся компания в области поставок электронных компонентов. Мы поставляем электронные компоненты отечественного и импортного производства напрямую от производителей и с крупнейших складов мира.

Благодаря сотрудничеству с мировыми поставщиками мы осуществляем комплексные и плановые поставки широчайшего спектра электронных компонентов.

Собственная эффективная логистика и склад в обеспечивает надежную поставку продукции в точно указанные сроки по всей России.

Мы осуществляем техническую поддержку нашим клиентам и предпродажную проверку качества продукции. На все поставляемые продукты мы предоставляем гарантию .

Осуществляем поставки продукции под контролем ВП МО РФ на предприятия военно-промышленного комплекса России , а также работаем в рамках 275 ФЗ с открытием отдельных счетов в уполномоченном банке. Система менеджмента качества компании соответствует требованиям ГОСТ ISO 9001.

Минимальные сроки поставки, гибкие цены, неограниченный ассортимент и индивидуальный подход к клиентам являются основой для выстраивания долгосрочного и эффективного сотрудничества с предприятиями радиоэлектронной промышленности, предприятиями ВПК и научно-исследовательскими институтами России.

С нами вы становитесь еще успешнее!

Наши контакты:

Телефон: +7 812 627 14 35

Электронная почта: sales@st-electron.ru

Адрес: 198099, Санкт-Петербург,
Промышленная ул, дом № 19, литера Н,
помещение 100-Н Офис 331