

Description

The AL5890 is a 400V constant current LED driver and it provides a cost-effective two pin solution. It has good temperature stability and the current accuracy of $< \pm 2.0\text{mA}$ (typ.) regulated over a wide voltage and temperature range. The AL5890 comes in various or pre-fixed output current options removing the need for external current setting resistors and creating a simple driver solution for the series of LEDs. The AL5890 supports both the high-side and low-side driving of LED chains.

The AL5890 turns on when the voltage between IN and OUT is greater than 7V. Long LED chain application up to 400V operating voltage subject to package thermal limitation.

The AL5890 is available in thermally robust PowerDI[®]123 (Type B), SOT89 and TO252 (Standard) packages.

Features

- DC up to 400V Operating Voltage With Long LED Chains Subject to Package Thermal Constraint
- LED Current Tolerance Over Wide Temperature Range $< \pm 2.0\text{mA}$ (typ.)
- Thermal Foldback Protection
- 10mA, 15mA, 20mA, 30mA, and 40mA pre-fixed Constant Output Current Options
- PowerDI123 (Type B), SOT89 and TO252 (Standard) Thermally Enhanced Packages
- **Totally Lead-Free & Fully RoHS Compliant (Notes 1 & 2)**
- **Halogen and Antimony Free. "Green" Device (Note 3)**

Pin Assignments (Top View)

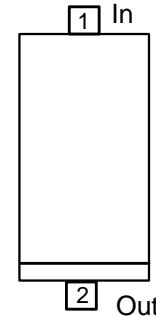

PowerDI123 (Type B)

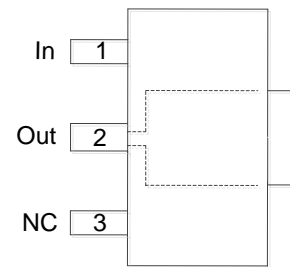

SOT89

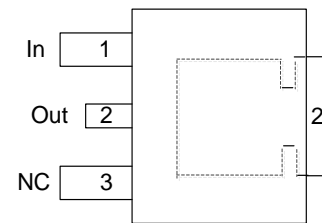

TO252 (Standard)

Applications

- Commercial LED Lighting Fixtures
- Emergency Lighting
- Signage, Downlights, Decorative and Architectural Lighting

- Notes:
1. No purposely added lead. Fully EU Directive 2002/95/EC (RoHS), 2011/65/EU (RoHS 2) & 2015/863/EU (RoHS 3) compliant.
 2. See <https://www.diodes.com/quality/lead-free/> for more information about Diodes Incorporated's definitions of Halogen- and Antimony-free, "Green" and Lead-free.
 3. Halogen- and Antimony-free "Green" products are defined as those which contain $< 900\text{ppm}$ bromine, $< 900\text{ppm}$ chlorine ($< 1500\text{ppm}$ total Br + Cl) and $< 1000\text{ppm}$ antimony compounds.

Typical Applications Circuit

(AC Configuration)

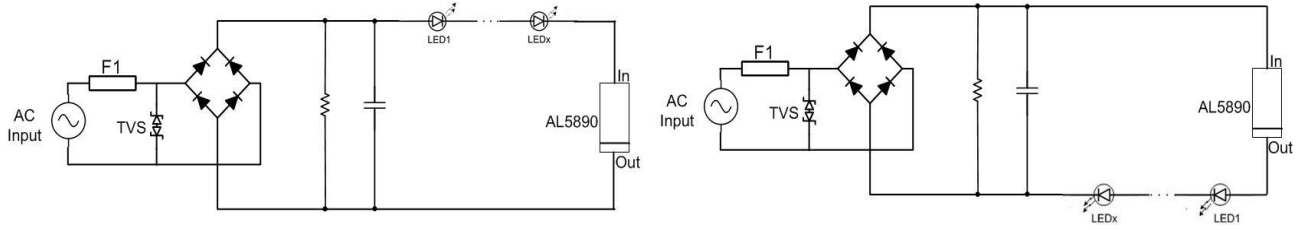

(DC Configuration)

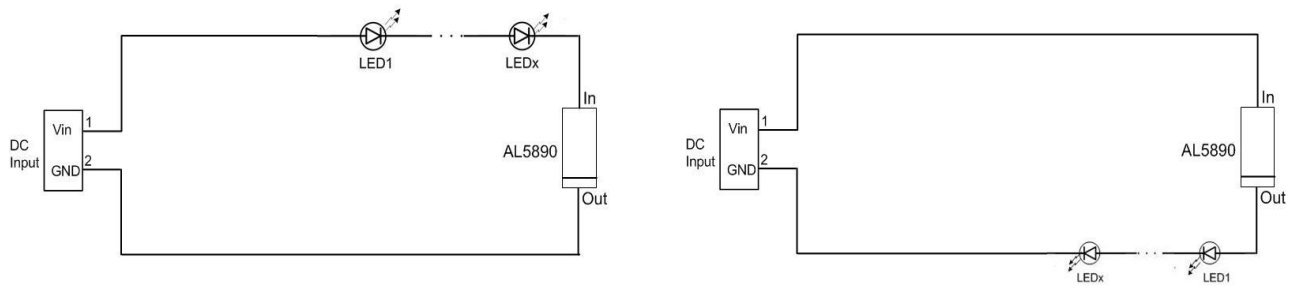

Pin Descriptions

Pin Name	Pin Number			Function
	PowerDI123 (Type B)	SOT89	TO252 (Standard)	
In	1	1	1	LED Current Input Terminal (Note 4)
Out	2	2	2	LED Current Output Terminal (Note 4)
NC	-	3	3	Not Connected
Exposed Pad	-	2	2	-

Note: 4. Stresses greater than the Absolute Maximum Ratings specified above may cause permanent damage to the device. These are stress ratings only, and functional operation of the device at these or any other conditions exceeding those indicated in this specification is not implied. Device reliability may be affected by exposure to absolute maximum rating conditions for extended periods of time. Semiconductor devices are ESD sensitive and may be damaged by exposure to ESD events. Suitable ESD precautions should be taken when handling and transporting these devices.

NEW PRODUCT

Functional Block Diagram

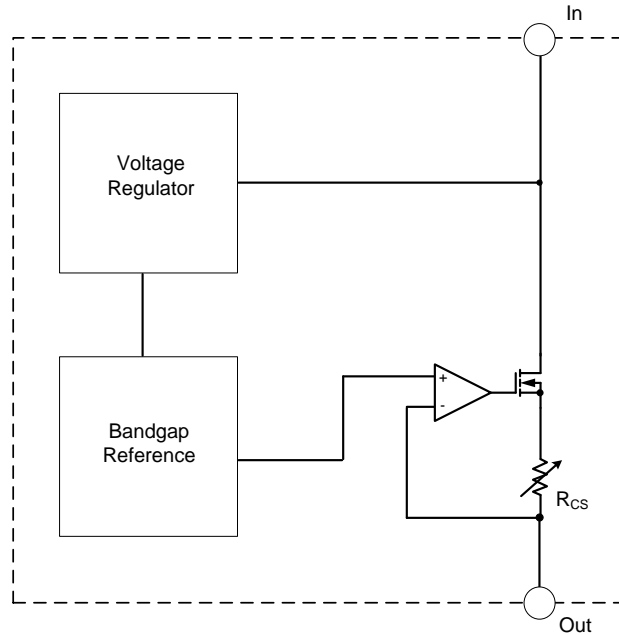

Absolute Maximum Ratings (Note 4)

Symbol	Parameters	Ratings	Unit
V_{IN_OUT}	IN Voltage Relative to OUT Pin	-0.3 to +425	V
I_{IN_OUT}	LED Current Flows from IN to OUT Pin	50	mA
T_J	Operating Junction Temperature	-40 to +150	°C
T_{ST}	Storage Temperature	-55 to +150	°C

ESD Ratings

Symbol	Parameter	Rating	Unit
V_{ESD}	Human-Body Model (HBM)	2000	V
	Charged-Device Model (CDM)	1000	

Recommended Operating Conditions

Symbol	Parameter	Min	Max	Unit
V_{IN_OUT}	IN Voltage Relative to OUT Pin	7	400	V
I_{IN_OUT}	Current Flows from IN to OUT Pin	10	40	mA
T_A	Operating Ambient Temperature Range	-40	+105	°C
T_J	Operating Junction Temperature	-40	+125	°C

NEW PRODUCT

Thermal Information (Note 5)

Package	θ_{JC} Thermal Resistance Junction-to-Case	θ_{JA} Thermal Resistance Junction-to-Ambient	P_{DIS} $T_A = +25^\circ\text{C}, T_J = +125^\circ\text{C}$
PowerDI123 (Type B)	15.33°C/W	75.84°C/W (Note 6)	1.33W
SOT89	6.34°C/W	27.85°C/W (Note 6)	3.61W
TO252 (Standard)	5.10°C/W	26.12°C/W (Note 6)	3.85W

- Note:
- When mounted on 50.8mm x 50.8mm GETEK PCB with 25.4mm x 25.4mm 2oz copper pads. For better thermal performance, larger copper pad for heat-sink is needed.
 - Stresses greater than the Absolute Maximum Ratings specified above may cause permanent damage to the device. These are stress ratings only, and functional operation of the device at these or any other conditions exceeding those indicated in this specification is not implied. Device reliability may be affected by exposure to absolute maximum rating conditions for extended periods of time. Semiconductor devices are ESD sensitive and may be damaged by exposure to ESD events. Suitable ESD precautions should be taken when handling and transporting these devices.

Electrical Characteristics ($V_{IN_OUT} = 10\text{V}, T_A = +25^\circ\text{C}, T_J < +125^\circ\text{C}$, Unless Otherwise Noted.)

Symbol	Parameter	Test Condition	Min	Typ	Max	Unit
V_{IN_OUT}	Supply Voltage	(Note 7)	7	-	400	V
V_{MIN}	Minimum Power Up Voltage	Increase V_{IN_OUT} (Note 8)	2.5	5	7	V
I_{IN_OUT}	LED Current (Note 9)	AL5890-10	9.0	10	11.0	mA
		AL5890-15	13.5	15	16.5	
		AL5890-20	18.5	20	21.5	
		AL5890-30	28.0	30	32.0	
		AL5890-40	38.0	40	42.0	
I_{LINE}	Line Regulation	$V_{IN_OUT} = 20\text{V to } 60\text{V}, 20\text{mA current option}$	-	1.5	-	%
T_{coeff}	Temperature Coefficient	(Note 10)	-	3	-	%
t_{ON}	Turn On Delay Time	-	-	6	-	μs
t_{OFF}	Turn Off Delay Time	-	-	0.3	-	μs
t_R	Rising Time	-	-	6	-	μs
t_F	Falling Time	-	-	0.1	-	μs
T_{FOLD}	Thermal Foldback Junction Temperature	Junction Temperature	-	+130	-	$^\circ\text{C}$

- Note:
- DC power supply slew rate set at 10V/msec to avoid any excessive inrush current.
 - Apply the power supply voltage linearly to the chip until the device starts to turn on (output LED current reaches 5% of the desired current options). The minimum power up voltage may vary with different current options.
 - Based on ATE trimmed accuracy at +25°C.
 - This parameter only guaranteed by design, not tested in production.

Typical Performance Characteristics (PowerDI123 (Type B), 20mA Device) – 1"x1" PCB with 2oz. Copper, no Heatsink

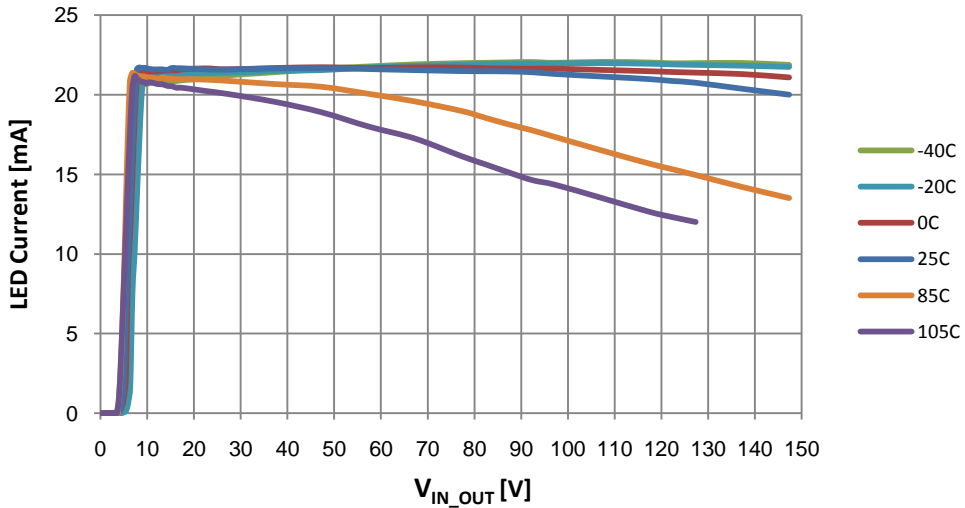

Figure 1. LED Current (-40°C to 105°C) vs. V_{IN_OUT}

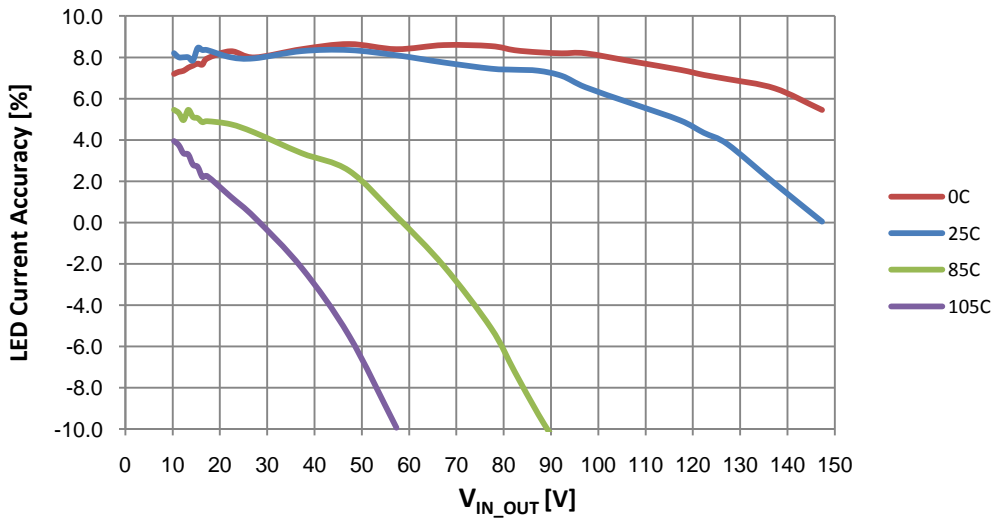

Figure 2. LED Current Accuracy (0°C to 105°C) vs. V_{IN_OUT}

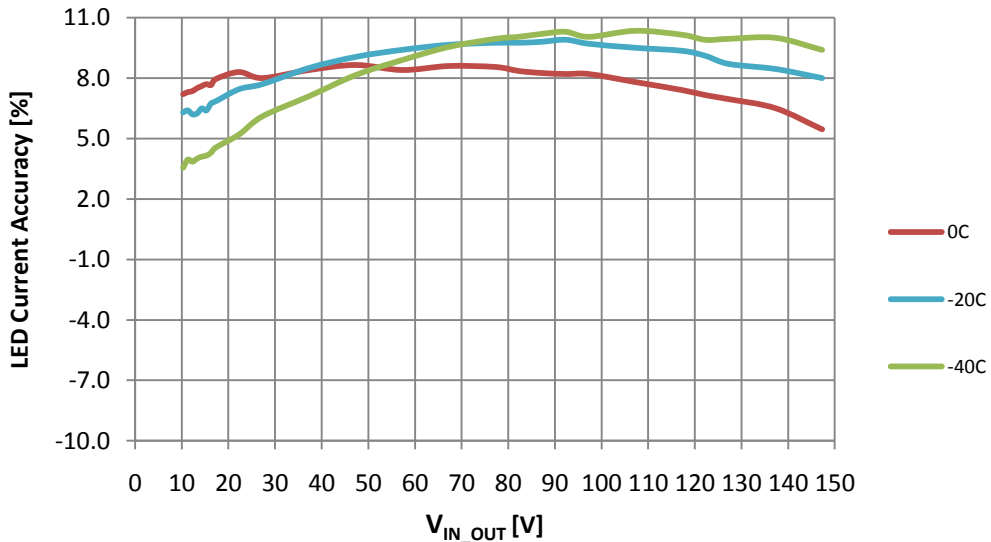

Figure 3. LED Current Accuracy (-40°C to 0°C) vs. V_{IN_OUT}

NEW PRODUCT

Typical Performance Characteristics (Cont.) (PowerDI123 (Type B), 20mA Device) – 1"x1" PCB with 2oz. Copper, no Heatsink

NEW PRODUCT

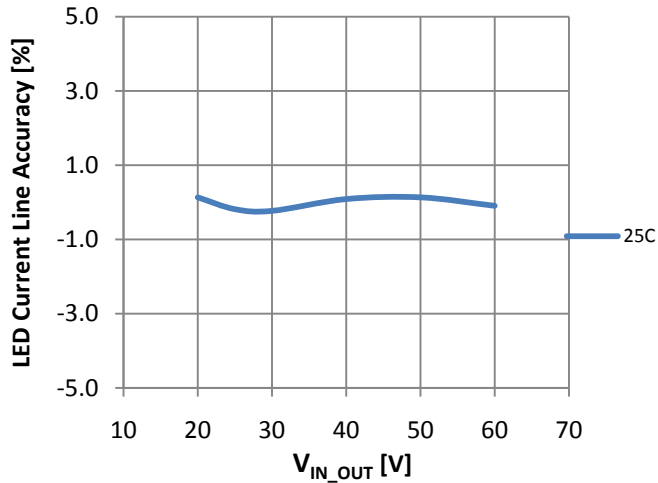

Figure 4. LED Line Regulation @ 25°C vs. V_{IN_OUT} (20V to 60V)

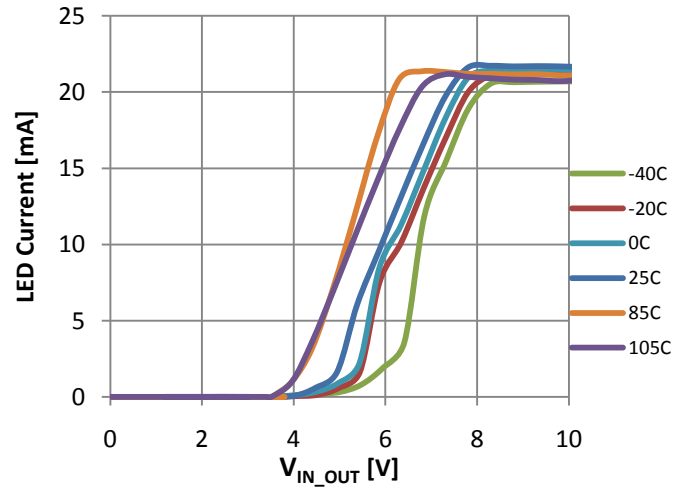

Figure 5. Startup Minimum Operating Voltage

Typical Performance Characteristics (40mA SOT89-3 Options) – 1"x1" PCB with 2oz. Copper, no Heatsink

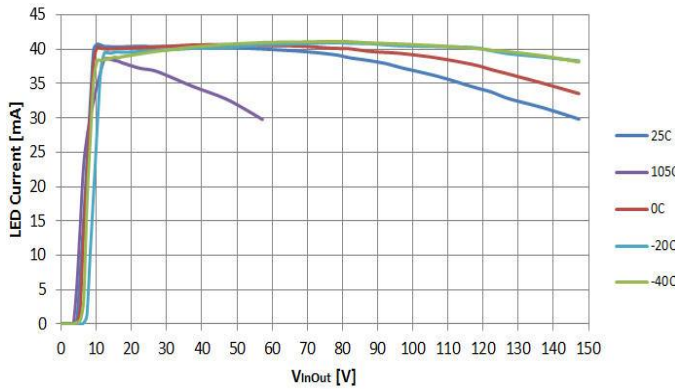

Figure 6. LED Current (-40°C to +105°C) vs. V_{IN_OUT}

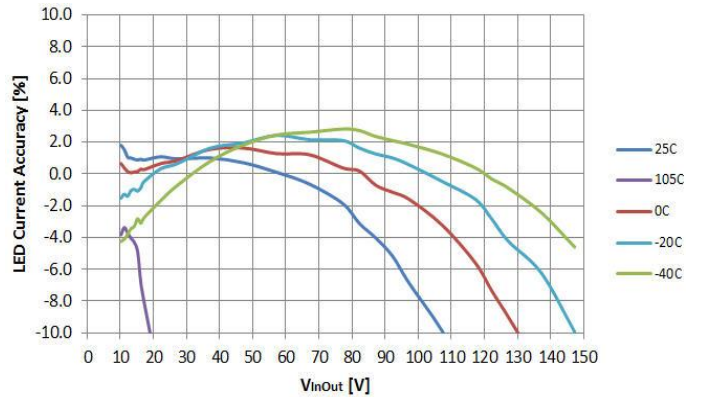

Figure 7. LED Current Accuracy (-40°C to +105°C) vs. V_{IN_OUT}

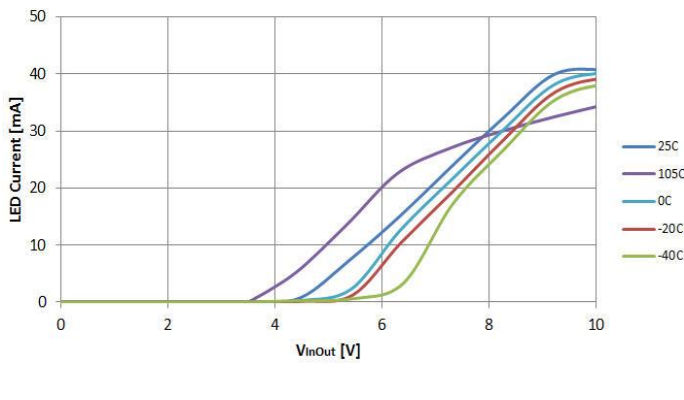

Figure 8. Device Turning On Threshold Across Temperature

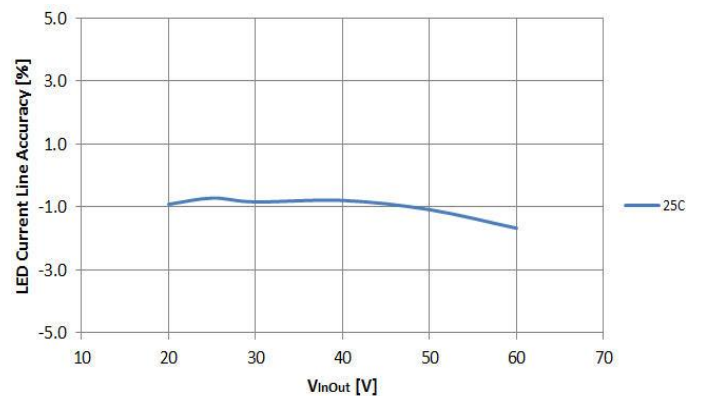

Figure 9. LED Line Regulation (% @ +25°C) vs. V_{IN_OUT} (20V to 60V)

Typical Performance Characteristics (40mA TO252 (Standard)-3 Options) – 1"x1" PCB with 2oz. Copper, no Heatsink

NEW PRODUCT

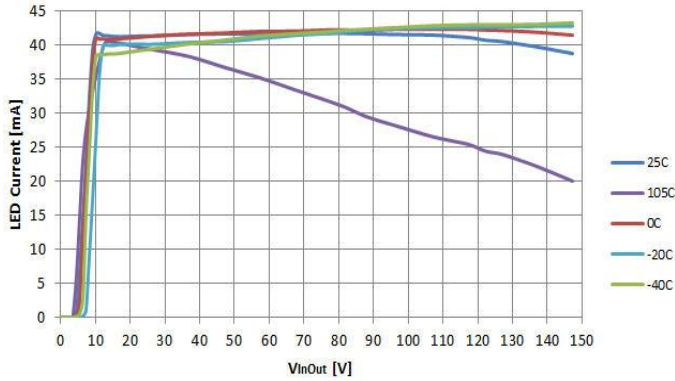

Figure 10. LED Current (-40°C to +105°C) vs. V_{IN_OUT}

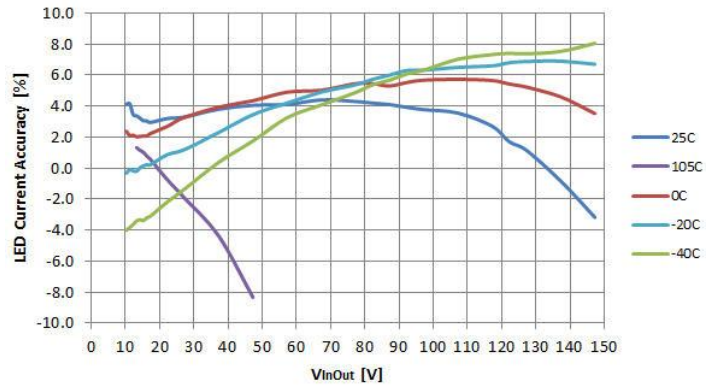

Figure 11. LED Current Accuracy (-40°C to +105°C) vs. V_{IN_OUT}

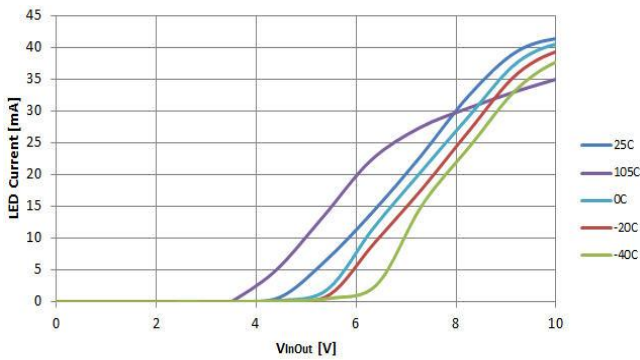

Figure 12. Device Turning On Threshold Across Temperature

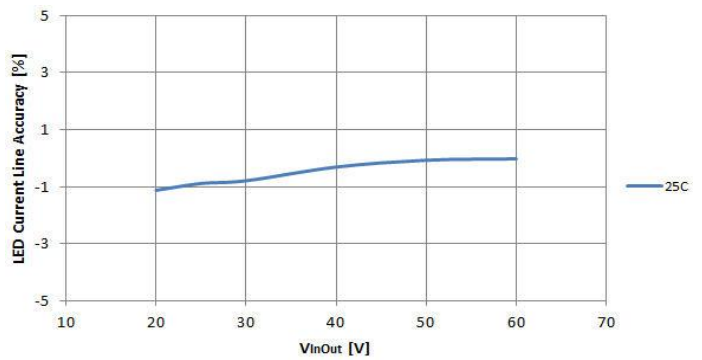

Figure 13. LED Line Regulation (% @ +25°C) vs. V_{IN_OUT} (20V to 60V)

Application Information

Description

The AL5890 is a constant current Linear LED driver and can be connected in series with LEDs as a High Side or a Low Side constant current regulator. The AL5890 offers various current settings from 10mA to 40mA and different current settings available upon request.

Simple LED String (AC/DC Configuration)

The AL5890 can be connected in series with LEDs as a Low Side or High Side constant current regulator. The number of the LEDs can vary from one to as many as supported by the input supply voltage. The designer needs to calculate the maximum voltage between IN pin and OUT pin by taking the maximum input voltage less the voltage across the LED string.

(AC Configuration)

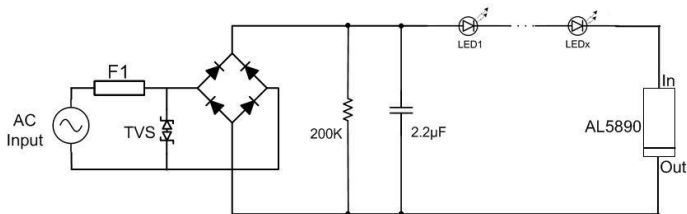

Figure 14. Low Side AC Application

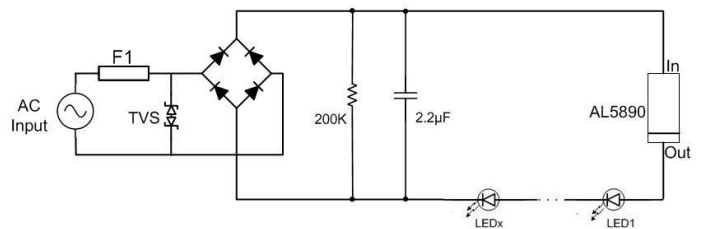

Figure 15. High Side AC Application

The AL5890 can also be used at the high side of the IC, see Figure 7. The minimum system input voltage can be calculated by:

$$V_{IN(MIN)} = V_{LED_CHAIN} + 7V, \text{ Where } V_{LED_CHAIN} \text{ is the LED chain voltage.}$$

(DC Configuration)

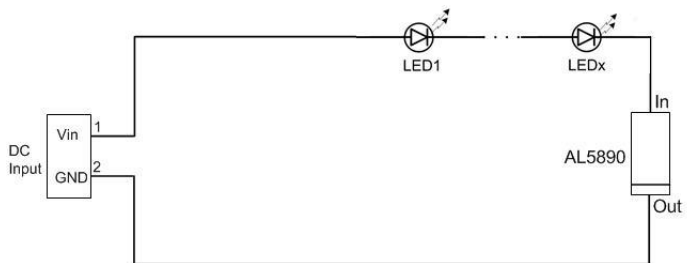

Figure 16. Low Side DC Application

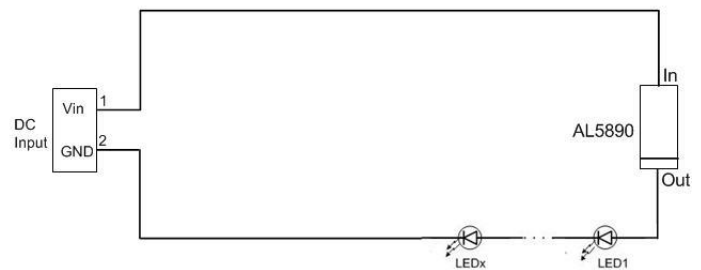

Figure 17. High Side DC Application

Application Information (Cont.)

Higher Current Requirement in Parallel Configuration

The LED current can be increased by connecting two or more AL5890 in parallel as Figure 10.

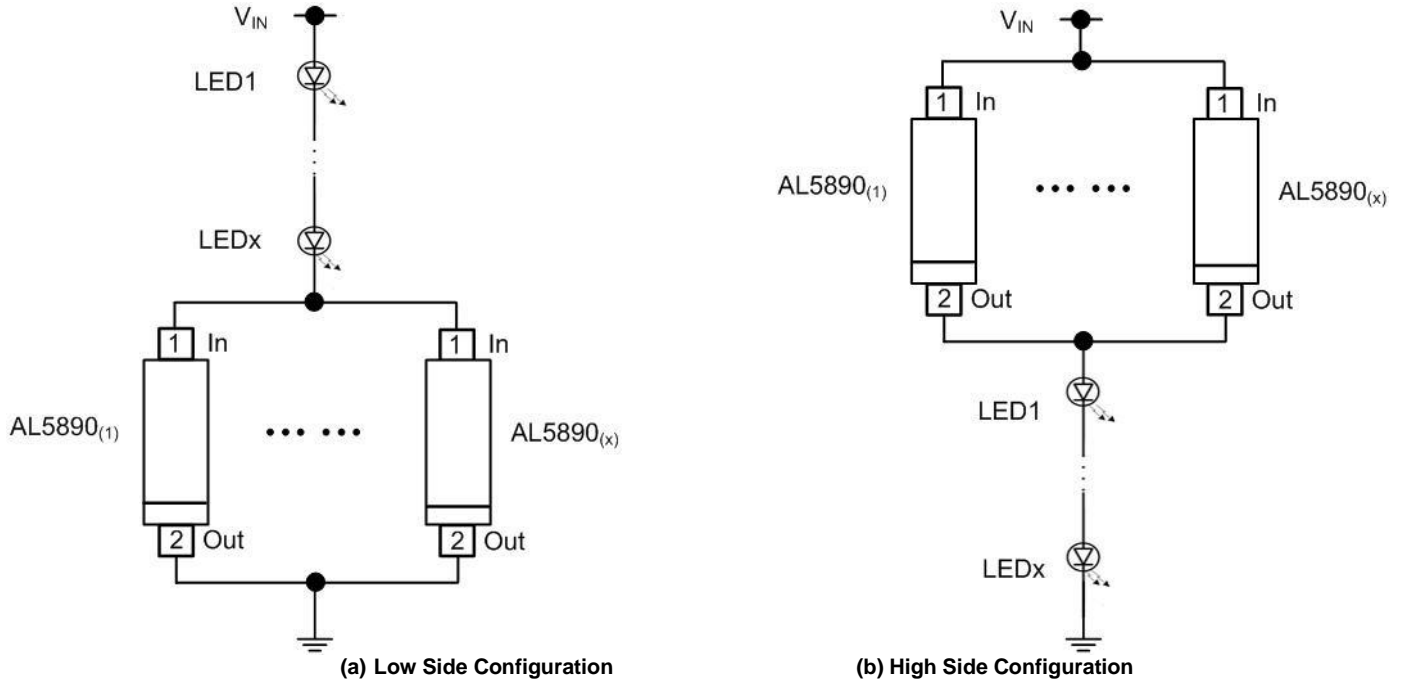

Figure 18. Parallel Configuration of AL5890

NEW PRODUCT

Application Information (Cont.)

Thermal Fold-back Protection (TFP)

The AL5890 has a thermal fold-back protection (TFP) function and adopts self-adaptive control method, which can prevent the system from breaking down caused by high temperature. The typical overheating temperature is set at +130°C, when the junction temperature of the IC is higher than +130°C, the device will linearly decrease the internal reference voltage to decrease the output current. As a result of this feature, the device can control the system's output power at high ambient temperature, to control the quantity of heat of the system. This enhances the safety of the system at high temperature.

Thermal fold-back waveform AL5890-10mA (PowerDI123 (Type B) package, 1"x1" PCB with 2oz copper, no heatsink) with $V_{IN_OUT} = 100V$ is shown as below:

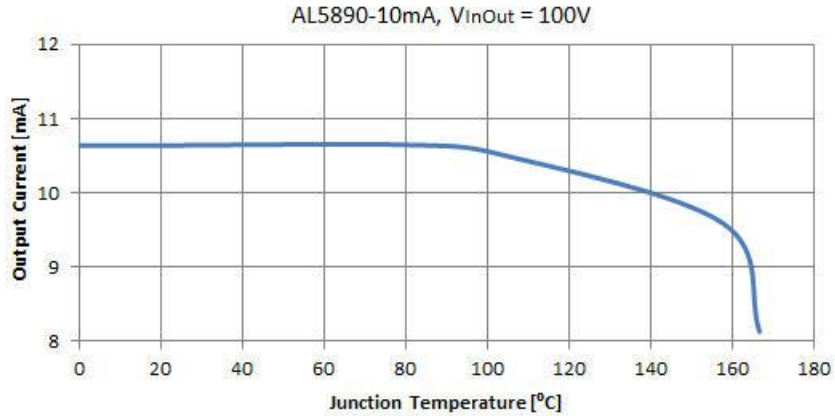

Figure 19. Thermal Foldback Characteristic

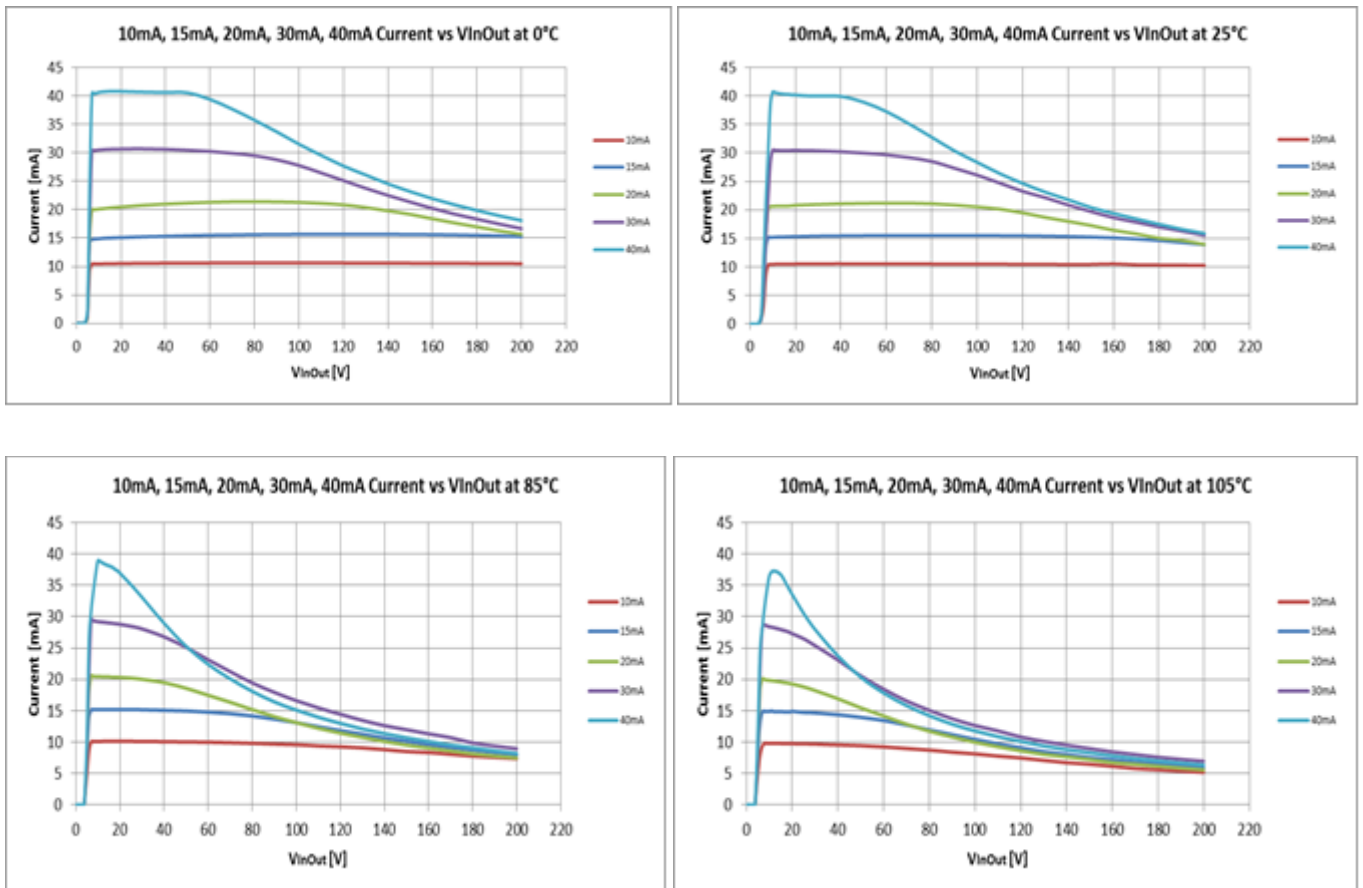
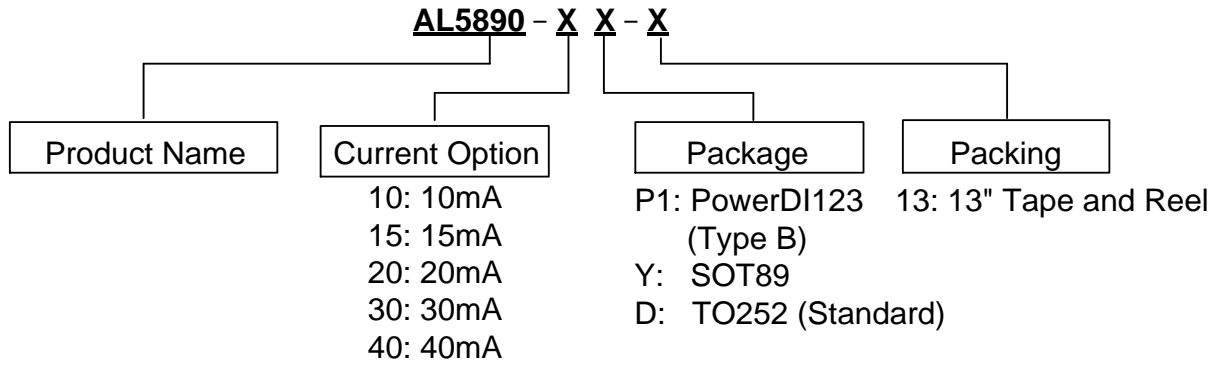

Figure 20. Thermal Foldback Characteristic with Different Current Option across Temperature

Ordering Information



Part Number	LED Current Option	Package Code	Packaging	13" Tape and Reel	
				Quantity	Part Number Suffix
AL5890-10P1-13	10mA	P1	PowerDI123 (Type B)	10,000/ Tape & Reel	-13
AL5890-15P1-13	15mA	P1	PowerDI123 (Type B)	10,000/ Tape & Reel	-13
AL5890-20P1-13	20mA	P1	PowerDI123 (Type B)	10,000/ Tape & Reel	-13
AL5890-30P1-13	30mA	P1	PowerDI123 (Type B)	10,000/ Tape & Reel	-13
AL5890-40P1-13	40mA	P1	PowerDI123 (Type B)	10,000/ Tape & Reel	-13
AL5890-10Y-13	10mA	Y	SOT89	2,500/ Tape & Reel	-13
AL5890-15Y-13	15mA	Y	SOT89	2,500/ Tape & Reel	-13
AL5890-20Y-13	20mA	Y	SOT89	2,500/ Tape & Reel	-13
AL5890-30Y-13	30mA	Y	SOT89	2,500/ Tape & Reel	-13
AL5890-40Y-13	40mA	Y	SOT89	2,500/ Tape & Reel	-13
AL5890-10D-13	10mA	D	TO252 (Standard)	2,500/ Tape & Reel	-13
AL5890-15D-13	15mA	D	TO252 (Standard)	2,500/ Tape & Reel	-13
AL5890-20D-13	20mA	D	TO252 (Standard)	2,500/ Tape & Reel	-13
AL5890-30D-13	30mA	D	TO252 (Standard)	2,500/ Tape & Reel	-13
AL5890-40D-13	40mA	D	TO252 (Standard)	2,500/ Tape & Reel	-13

NEW PRODUCT

Marking Information

(1) PowerDI123 (Type B)

(Top View)

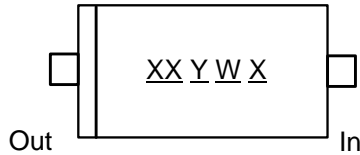

XX: Identification code

Y: Year 0 to 9

W: Week : A to Z : 1 to 26 week;
a to z : 27 to 52 week; z represents 52 and 53 week

X: Internal code

Part Number	Package	Identification Code
AL5890-10P1-13	PowerDI123 (Type B)	B2
AL5890-15P1-13	PowerDI123 (Type B)	B3
AL5890-20P1-13	PowerDI123 (Type B)	B4
AL5890-30P1-13	PowerDI123 (Type B)	B5
AL5890-40P1-13	PowerDI123 (Type B)	B6

(2) SOT89

(Top View)

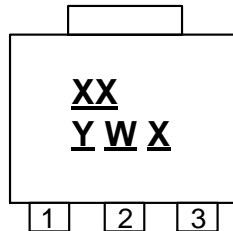

XX : Identification code

Y : Year : 0~9

W : Week : A~Z : 1~26 week;
a~z : 27~52 week;
z represents 52 and 53 week

X : Internal code

Part Number	Package	Identification Code
AL5890-10Y-13	SOT89	B2
AL5890-15Y-13	SOT89	B3
AL5890-20Y-13	SOT89	B4
AL5890-30Y-13	SOT89	B5
AL5890-40Y-13	SOT89	B6

(3) TO252 (Standard)

(Top View)

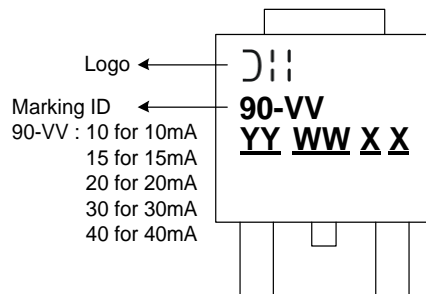

YY : Year : 01 to 09

WW : Week : 01 to 52, 52 represents 52 and 53 week

XX : Internal Code

Marking ID
90-VV : 10 for 10mA
15 for 15mA
20 for 20mA
30 for 30mA
40 for 40mA

Marking Information (Cont.)

Part Number	Package	Identification Code
AL5890-10D-13	TO252 (Standard)	B2
AL5890-15D-13	TO252 (Standard)	B3
AL5890-20D-13	TO252 (Standard)	B4
AL5890-30D-13	TO252 (Standard)	B5
AL5890-40D-13	TO252 (Standard)	B6

Package Outline Dimensions

Please see <http://www.diodes.com/package-outlines.html> for the latest version.

(1) PowerDI123 (Type B)

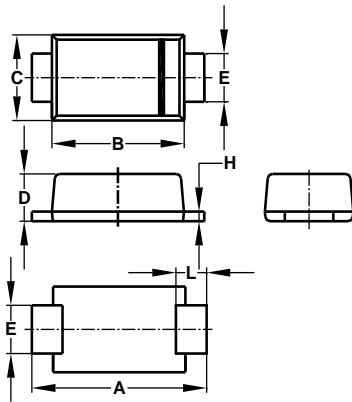

PowerDI123 (Type B)			
Dim	Min	Max	Typ
A	3.50	3.90	3.70
B	2.60	3.00	2.80
C	1.63	1.93	1.78
D	0.93	1.00	0.98
E	0.85	1.25	1.00
H	0.15	0.25	0.20
L	0.50	0.80	0.65
All Dimensions in mm			

(2) SOT89

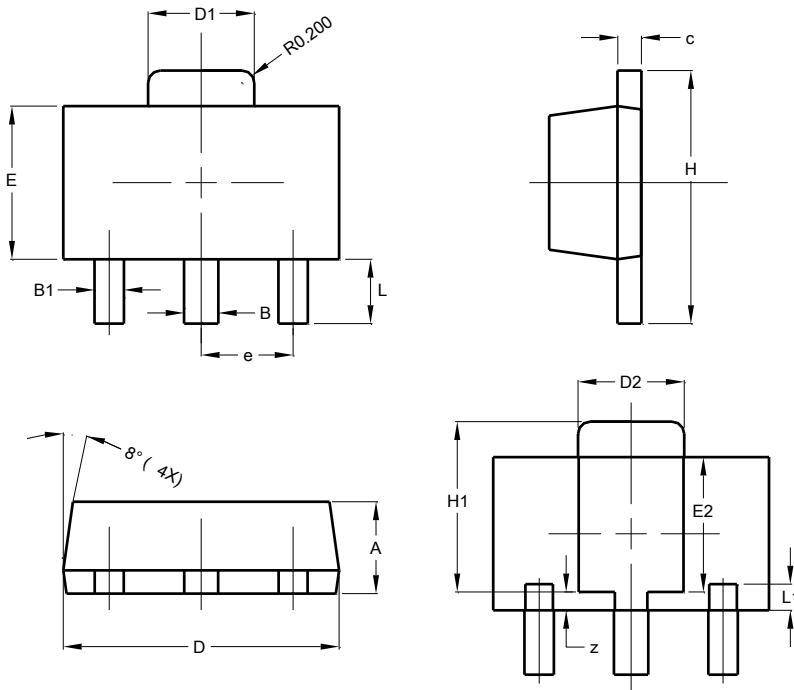

SOT89			
Dim	Min	Max	Typ
A	1.40	1.60	1.50
B	0.50	0.62	0.56
B1	0.42	0.54	0.48
c	0.35	0.43	0.38
D	4.40	4.60	4.50
D1	1.62	1.83	1.733
D2	1.61	1.81	1.71
E	2.40	2.60	2.50
E2	2.05	2.35	2.20
e	-	-	1.50
H	3.95	4.25	4.10
H1	2.63	2.93	2.78
L	0.90	1.20	1.05
L1	0.327	0.527	0.427
z	0.20	0.40	0.30
All Dimensions in mm			

Package Outline Dimensions (Cont.)

Please see <http://www.diodes.com/package-outlines.html> for the latest version.

(3) TO252 (Standard)

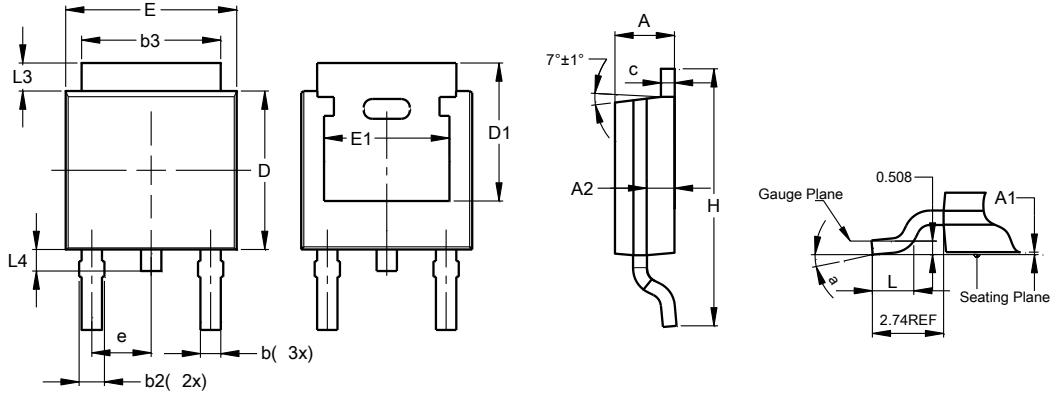

TO252 (Standard)			
Dim	Min	Max	Typ
A	2.19	2.39	2.29
A1	0.00	0.13	0.08
A2	0.97	1.17	1.07
b	0.64	0.88	0.783
b2	0.76	1.14	0.95
b3	5.21	5.46	5.33
c	0.45	0.58	0.531
D	6.00	6.20	6.10
D1	5.21	-	-
e	-	-	2.286
E	6.45	6.70	6.58
E1	4.32	-	-
H	9.40	10.41	9.91
L	1.40	1.78	1.59
L3	0.88	1.27	1.08
L4	0.60	1.02	0.83
a	0°	10°	-
All Dimensions in mm			

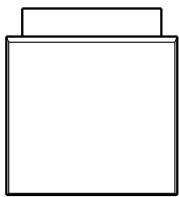

Option A
(Top View)

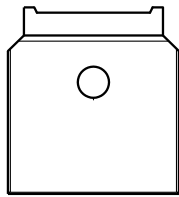

Option B
(Top View)

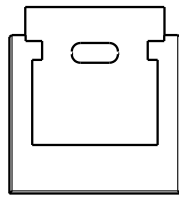

Option A
(Bottom View)

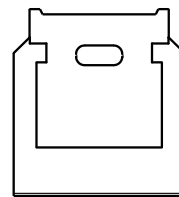

Option B
(Bottom View)

Suggested Pad Layout

Please see <http://www.diodes.com/package-outlines.html> for the latest version.

(1) PowerDI123 (Type B)

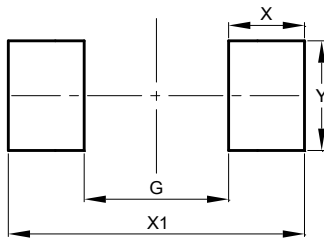

Dimensions	Value (in mm)
G	2.000
X	1.050
X1	4.100
Y	1.500

Suggested Pad Layout (Cont.)

Please see <http://www.diodes.com/package-outlines.html> for the latest version.

(2) SOT89

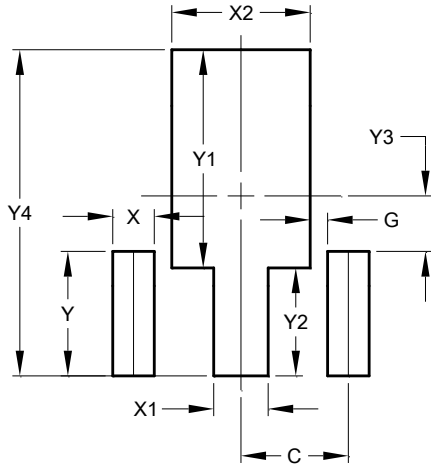

Dimensions	Value (in mm)
C	1.500
G	0.244
X	0.580
X1	0.760
X2	1.933
Y	1.730
Y1	3.030
Y2	1.500
Y3	0.770
Y4	4.530

(3) TO252 (Standard)

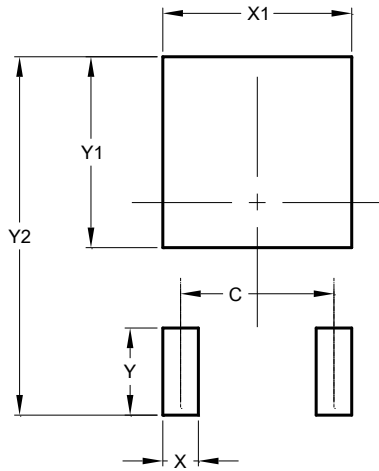

Dimensions	Value (in mm)
C	4.572
X	1.060
X1	5.632
Y	2.600
Y1	5.700
Y2	10.700

NEW PRODUCT

Taping Orientation

The taping orientation of the other package type can be found on our website at <http://www.diodes.com/datasheets/ap02007.pdf>.

NEW PRODUCT

PowerDI123 (Type B)

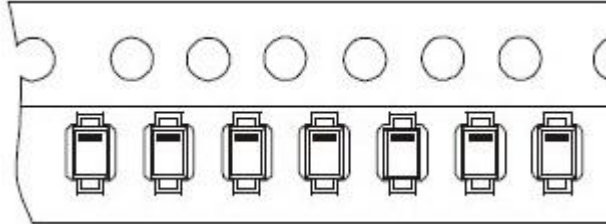

SOT89

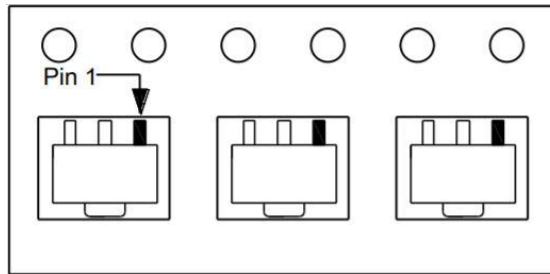

TO252 (Standard)

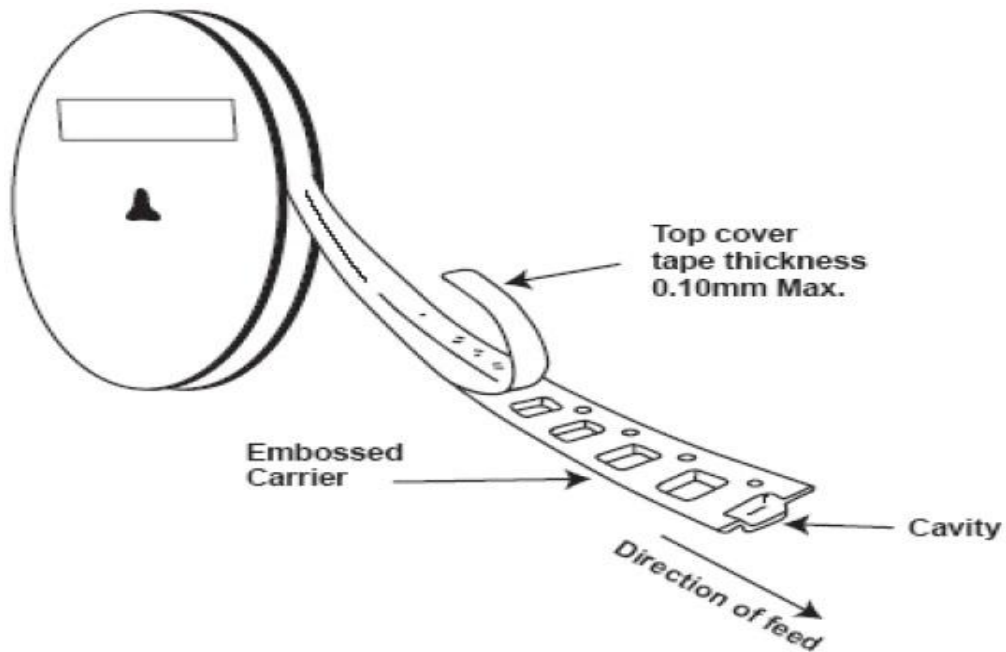
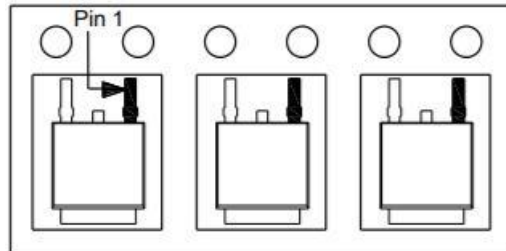

IMPORTANT NOTICE

DIODES INCORPORATED MAKES NO WARRANTY OF ANY KIND, EXPRESS OR IMPLIED, WITH REGARDS TO THIS DOCUMENT, INCLUDING, BUT NOT LIMITED TO, THE IMPLIED WARRANTIES OF MERCHANTABILITY AND FITNESS FOR A PARTICULAR PURPOSE (AND THEIR EQUIVALENTS UNDER THE LAWS OF ANY JURISDICTION).

Diodes Incorporated and its subsidiaries reserve the right to make modifications, enhancements, improvements, corrections or other changes without further notice to this document and any product described herein. Diodes Incorporated does not assume any liability arising out of the application or use of this document or any product described herein; neither does Diodes Incorporated convey any license under its patent or trademark rights, nor the rights of others. Any Customer or user of this document or products described herein in such applications shall assume all risks of such use and will agree to hold Diodes Incorporated and all the companies whose products are represented on Diodes Incorporated website, harmless against all damages.

Diodes Incorporated does not warrant or accept any liability whatsoever in respect of any products purchased through unauthorized sales channel. Should Customers purchase or use Diodes Incorporated products for any unintended or unauthorized application, Customers shall indemnify and hold Diodes Incorporated and its representatives harmless against all claims, damages, expenses, and attorney fees arising out of, directly or indirectly, any claim of personal injury or death associated with such unintended or unauthorized application.

Products described herein may be covered by one or more United States, international or foreign patents pending. Product names and markings noted herein may also be covered by one or more United States, international or foreign trademarks.

This document is written in English but may be translated into multiple languages for reference. Only the English version of this document is the final and determinative format released by Diodes Incorporated.

LIFE SUPPORT

Diodes Incorporated products are specifically not authorized for use as critical components in life support devices or systems without the express written approval of the Chief Executive Officer of Diodes Incorporated. As used herein:

A. Life support devices or systems are devices or systems which:

1. are intended to implant into the body, or
2. support or sustain life and whose failure to perform when properly used in accordance with instructions for use provided in the labeling can be reasonably expected to result in significant injury to the user.

B. A critical component is any component in a life support device or system whose failure to perform can be reasonably expected to cause the failure of the life support device or to affect its safety or effectiveness.

Customers represent that they have all necessary expertise in the safety and regulatory ramifications of their life support devices or systems, and acknowledge and agree that they are solely responsible for all legal, regulatory and safety-related requirements concerning their products and any use of Diodes Incorporated products in such safety-critical, life support devices or systems, notwithstanding any devices- or systems-related information or support that may be provided by Diodes Incorporated. Further, Customers must fully indemnify Diodes Incorporated and its representatives against any damages arising out of the use of Diodes Incorporated products in such safety-critical, life support devices or systems.

Copyright © 2018, Diodes Incorporated

www.diodes.com



Стандарт Электрон Связь

Мы молодая и активно развивающаяся компания в области поставок электронных компонентов. Мы поставляем электронные компоненты отечественного и импортного производства напрямую от производителей и с крупнейших складов мира.

Благодаря сотрудничеству с мировыми поставщиками мы осуществляем комплексные и плановые поставки широчайшего спектра электронных компонентов.

Собственная эффективная логистика и склад в обеспечивает надежную поставку продукции в точно указанные сроки по всей России.

Мы осуществляем техническую поддержку нашим клиентам и предпродажную проверку качества продукции. На все поставляемые продукты мы предоставляем гарантию .

Осуществляем поставки продукции под контролем ВП МО РФ на предприятия военно-промышленного комплекса России , а также работаем в рамках 275 ФЗ с открытием отдельных счетов в уполномоченном банке. Система менеджмента качества компании соответствует требованиям ГОСТ ISO 9001.

Минимальные сроки поставки, гибкие цены, неограниченный ассортимент и индивидуальный подход к клиентам являются основой для выстраивания долгосрочного и эффективного сотрудничества с предприятиями радиоэлектронной промышленности, предприятиями ВПК и научно-исследовательскими институтами России.

С нами вы становитесь еще успешнее!

Наши контакты:

Телефон: +7 812 627 14 35

Электронная почта: sales@st-electron.ru

Адрес: 198099, Санкт-Петербург,
Промышленная ул, дом № 19, литера Н,
помещение 100-Н Офис 331