

# CPMA0060002F

## 2 W, 20 MHz - 6000 MHz, GaN MMIC Power Amplifier

Cree's CPMA0060002F is a gallium nitride (GaN) High Electron Mobility Transistor (HEMT) based monolithic microwave integrated circuit (MMIC). GaN has superior properties compared to silicon or gallium arsenide, including higher breakdown voltage, higher saturated electron drift velocity and higher thermal conductivity. GaN HEMTs also offer greater power density and wider bandwidths compared to Si and GaAs transistors. This MMIC employs a distributed (traveling-wave) amplifier design approach, enabling extremely wide bandwidths to be achieved in a small footprint screw-down package featuring a copper-tungsten heat sink.

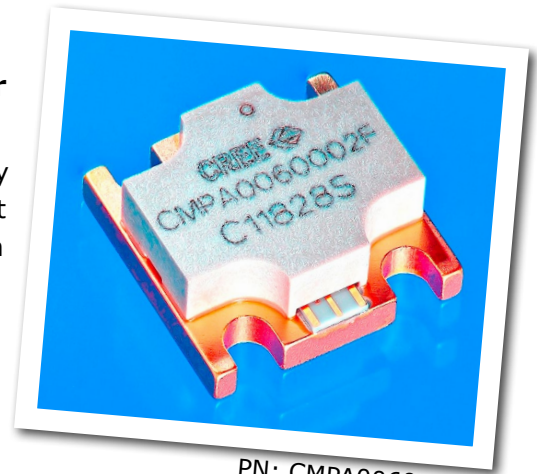

PN: CPMA0060002F  
Package Type: 780019

### Typical Performance Over 20 MHz - 6.0 GHz ( $T_c = 25^\circ\text{C}$ )

Parameter	20 MHz	0.5 GHz	1.0 GHz	2.0 GHz	3.0 GHz	4.0 GHz	5.0 GHz	6.0 GHz	Units
Gain	19.9	18.8	17.8	16.8	16.8	17.5	18.5	16.5	dB
Saturated Output Power, $P_{SAT}^1$	4.3	4.1	4.5	4.2	3.7	3.9	4.8	3.7	W
Power Gain @ $P_{SAT}^1$	14.7	13.1	12.6	12.2	12.6	10.9	12.2	9.5	dB
PAE @ $P_{SAT}^1$	34	28	29	28	24	26	33	20	%

Note<sup>1</sup>:  $P_{SAT}$  is defined as the RF output power where the device starts to draw positive gate current in the range of 2-4 mA.

Note<sup>2</sup>:  $V_{DD} = 28\text{ V}$ ,  $I_{DQ} = 100\text{ mA}$

### Features

- 17 dB Small Signal Gain
- 3 W Typical  $P_{SAT}$
- Operation up to 28 V
- High Breakdown Voltage
- High Temperature Operation
- 0.5" x 0.5" total product size

### Applications

- Ultra Broadband Amplifiers
- Fiber Drivers
- Test Instrumentation
- EMC Amplifier Drivers

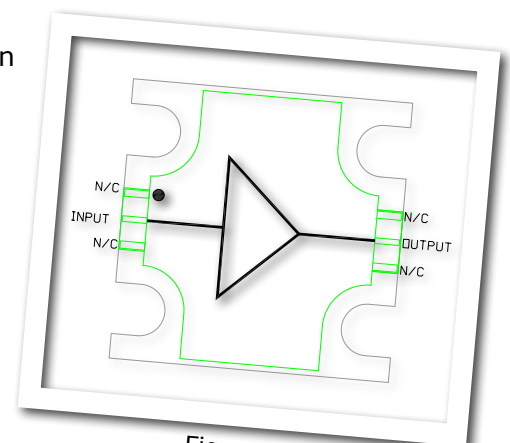

Figure 1.



## Absolute Maximum Ratings (not simultaneous) at 25 °C

Parameter	Symbol	Rating	Units
Drain-source Voltage	$V_{DSS}$	84	VDC
Gate-source Voltage	$V_{GS}$	-10, +2	VDC
Storage Temperature	$T_{STG}$	-65, +150	°C
Operating Junction Temperature	$T_J$	225	°C
Maximum Forward Gate Current	$I_{GMAX}$	4	mA
Soldering Temperature <sup>1</sup>	$T_S$	245	°C
Screw Torque	$\tau$	40	in-oz
Thermal Resistance, Junction to Case	$R_{\theta JC}$	4.3	°C/W
Case Operating Temperature <sup>2,3</sup>	$T_C$	-40, +150	°C

Note:

<sup>1</sup> Refer to the Application Note on soldering at [www.cree.com/products/wireless\\_appnotes.asp](http://www.cree.com/products/wireless_appnotes.asp)

<sup>2</sup> Measured for the CMPA0060002F at  $P_{DISS} = 2$  W.

## Electrical Characteristics (Frequency = 20 MHz to 6.0 GHz unless otherwise stated; $T_C = 25^\circ\text{C}$ )

Characteristics	Symbol	Min.	Typ.	Max.	Units	Conditions
<b>DC Characteristics</b>						
Gate Threshold Voltage <sup>1</sup>	$V_{(GS)TH}$	-3.8	-3.0	-2.7	V	$V_{DS} = 20$ V, $\Delta I_D = 2$ mA
Gate Quiescent Voltage	$V_{(GS)Q}$	-	-2.7	-	VDC	$V_{DD} = 28$ V, $I_{DQ} = 100$ mA
Saturated Drain Current	$I_{DC}$	-	1.4	-	A	$V_{DS} = 6.0$ V, $V_{GS} = 2.0$ V
<b>RF Characteristics</b>						
Small Signal Gain	S21	13.5	17	21.5	dB	$V_{DD} = 28$ V, $I_{DQ} = 100$ mA
Input Return Loss	S11	-	-9	-5	dB	$V_{DD} = 28$ V, $I_{DQ} = 100$ mA
Output Return Loss	S22	-	-9	-5	dB	$V_{DD} = 28$ V, $I_{DQ} = 100$ mA
Power Output	$P_{OUT}$	2	3	-	W	$V_{DD} = 28$ V, $I_{DQ} = 100$ mA, Frequency = 4.0 GHz, $P_{IN} = 23$ dBm
Power Added Efficiency	PAE	-	23	-	%	$V_{DD} = 28$ V, $I_{DQ} = 100$ mA, Frequency = 4.0 GHz, $P_{IN} = 23$ dBm
Power Gain	$G_p$	10	-	-	dB	$V_{DD} = 28$ V, $I_{DQ} = 100$ mA, Frequency = 4.0 GHz, $P_{IN} = 23$ dBm
Output Mismatch Stress	VSWR	-	-	5 : 1	$\Psi$	No damage at all phase angles, $V_{DD} = 28$ V, $I_{DQ} = 100$ mA, $P_{IN} = 23$ dBm

Notes:

<sup>1</sup> The device will draw approximately 20-25 mA at pinch off due to the internal circuit structure.

## Typical Performance

### Small Signal Gain and Return Losses vs Frequency at 28 V

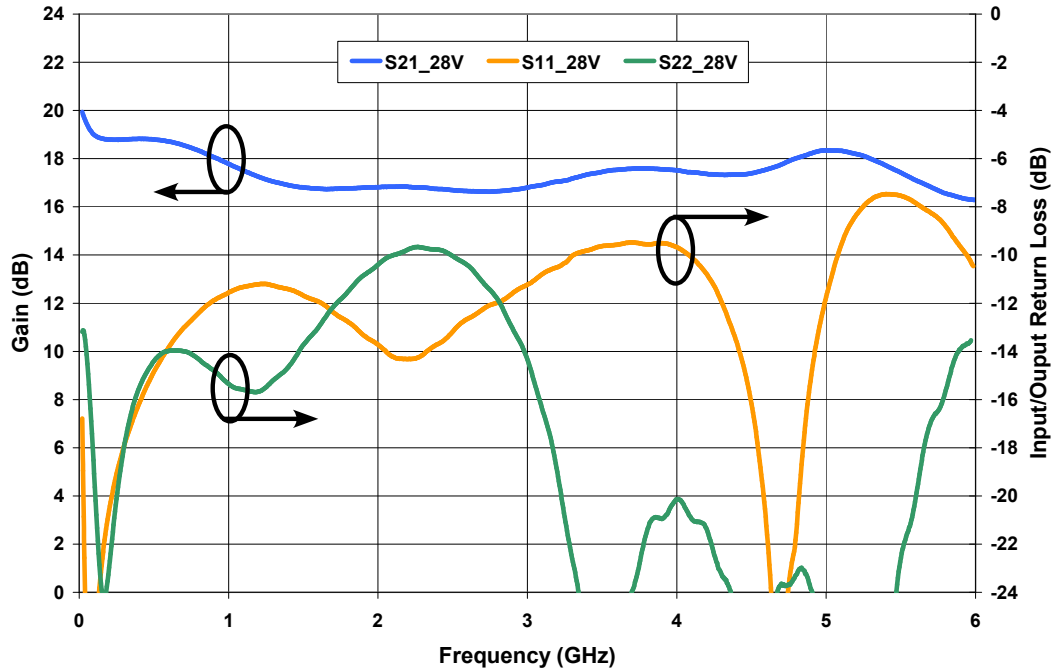

### Power Gain vs Frequency at 28V

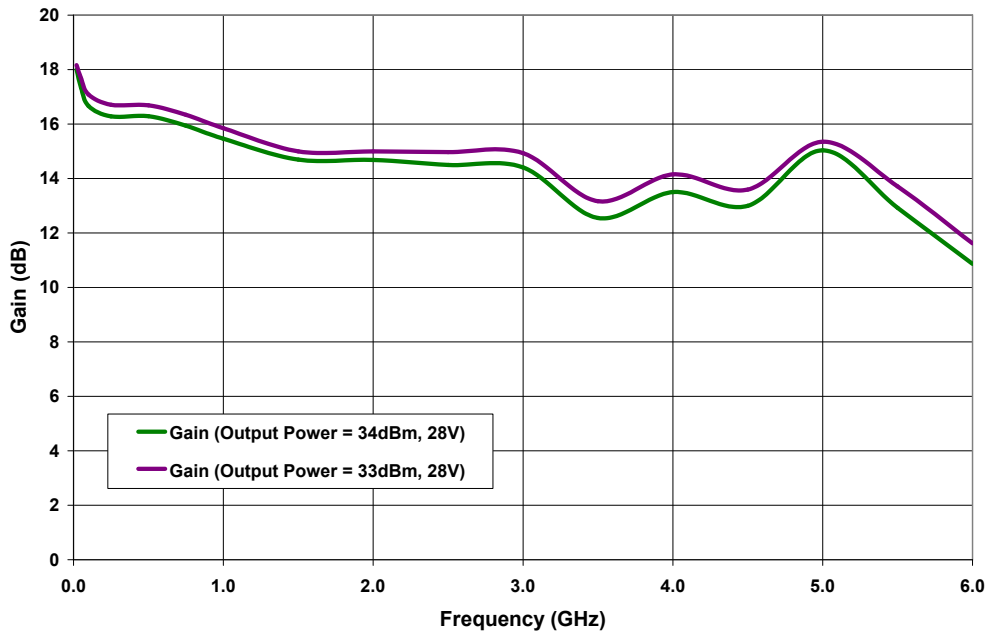



## Typical Performance

### Saturated Output Power Performance ( $P_{SAT}$ ) vs Frequency

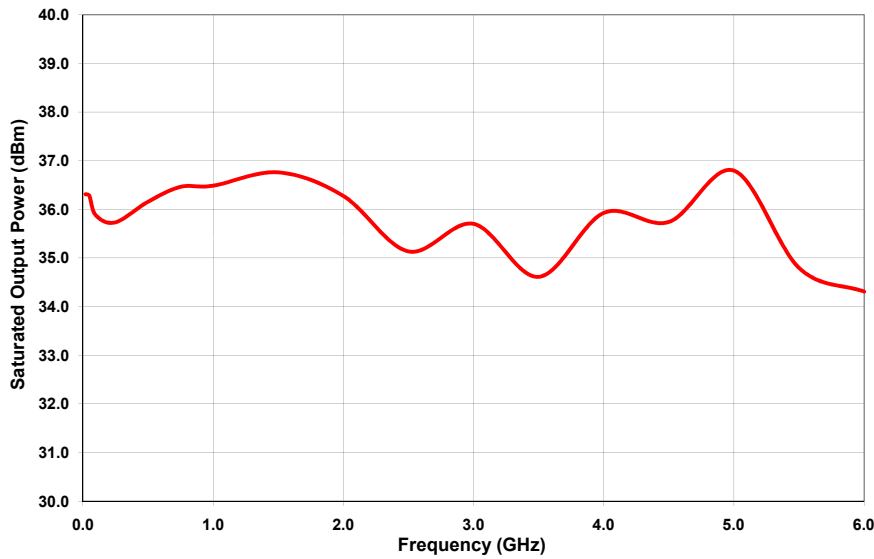

Frequency (GHz)	$P_{SAT}$ at 28V (dBm)	$P_{SAT}$ at 28V (W)
0.02	36.6	4.3
0.5	36.2	4.1
1.0	36.5	4.5
1.5	36.8	4.7
2.0	36.3	4.2
2.5	35.1	3.3
3.0	35.7	3.7
3.5	34.6	2.9
4.0	35.9	3.9
4.5	35.7	3.8
5.0	36.8	4.8
5.5	34.8	3.0
6.0	34.3	2.7

Note:  $P_{SAT}$  is defined as the RF output power where the device starts to draw positive gate current in the range of 2-4 mA.

### PAE at 33 & 34 dBm Output Power vs Frequency at 28 V

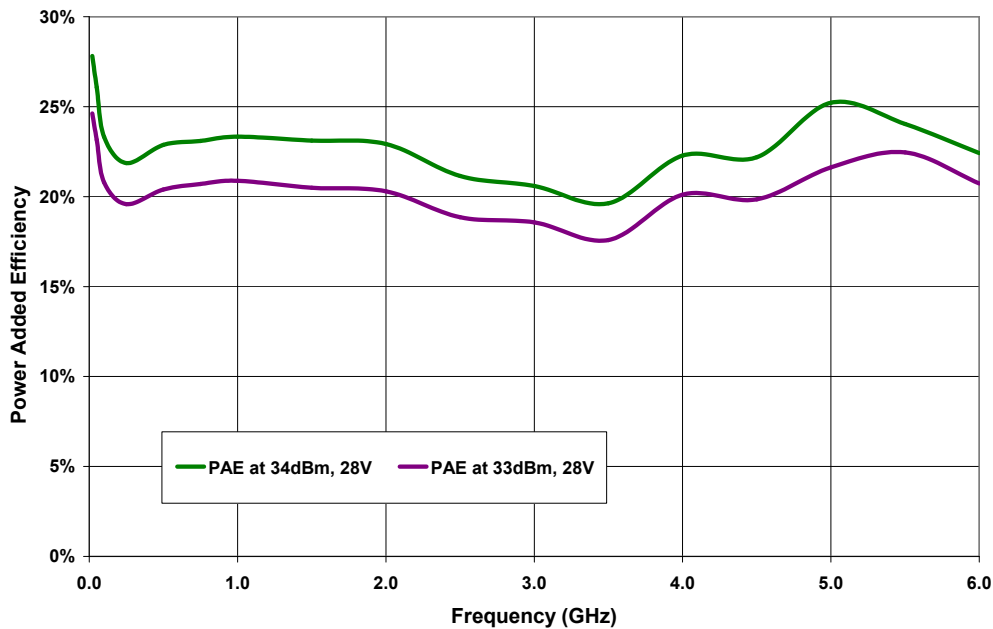

## General Device Information

The CMPA0060002F is a GaN HEMT MMIC Distributed Driver Amplifier, which operates between 20 MHz - 6.0 GHz. The amplifier typically provides 17 dB of small signal gain and 2 W saturated output power with an associated power added efficiency of better than 20 %. The wideband amplifier's input and output are internally matched to 50 Ohm. The amplifier requires bias from appropriate Bias-T's, through the RF input and output ports.

The CMPA0060002F is provided in a flange package format. The input and output connections are gold plated to enable gold bond wire attach at the next level assembly.

The measurements in this data sheet were taken on devices wire-bonded to the test fixture with 2 mil gold bond wires. The CMPA0060002F-TB and the device were then measured using external Bias-T's, (Aeroflex: 8800, SMF3-12; TECDIA: TBT-06M20 or similar), as shown in Figure 2. The Bias-T's were included in the calibration of the test system. All other losses associated with the test fixture are included in the measurements.

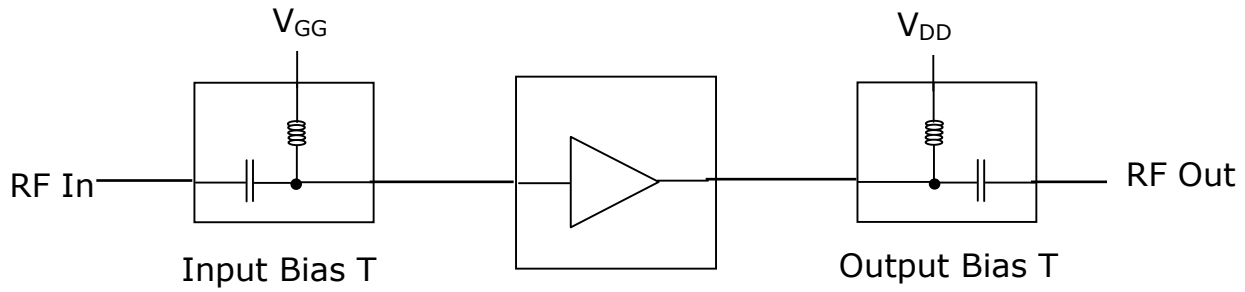

CMPA0060002F mounted  
in the test fixture

Figure 2. Typical test system setup required for measuring CMPA0060002F-TB

## Electrostatic Discharge (ESD) Classifications

Parameter	Symbol	Class	Test Methodology
Human Body Model	HBM	1A (> 250 V)	JEDEC JESD22 A114-D
Charge Device Model	CDM	II (200 < 500 V)	JEDEC JESD22 C101-C

## CMPA0060002F-TB Demonstration Amplifier Circuit

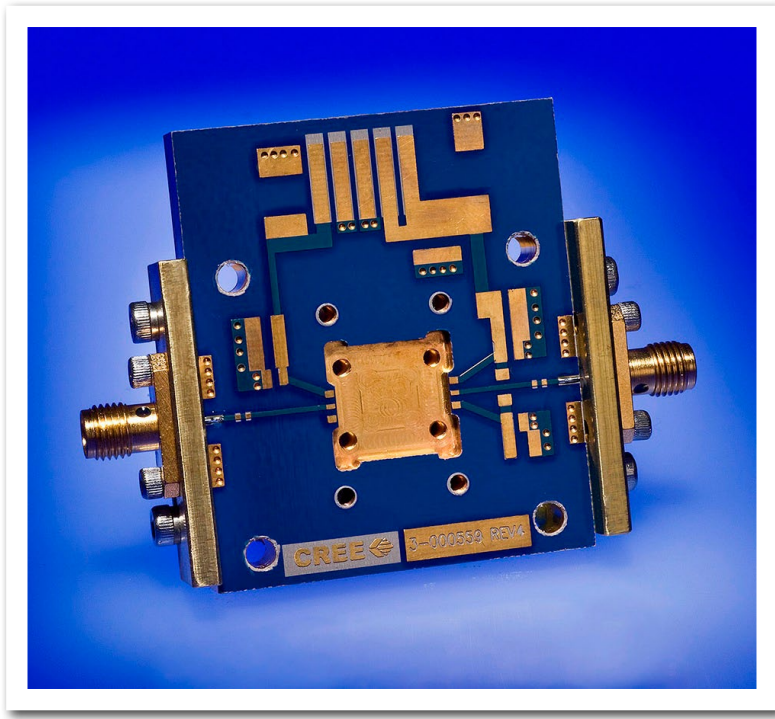

## CMPA0060002F-TB Demonstration Amplifier Circuit Outline

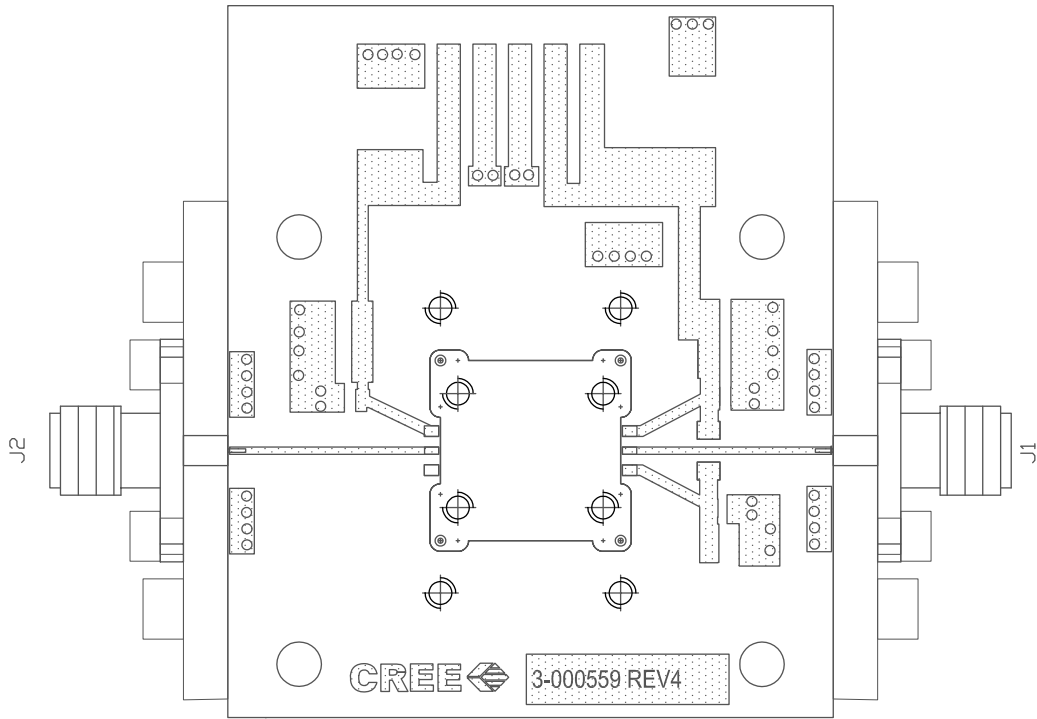

## CMPA006002F-TB Demonstration Amplifier Circuit Bill of Materials

Designator	Description	Qty
J1,J2	CONNECTOR, SMA, AMP1052901-1	2
-	PCB, TACONIC, RF-35-0100-CH/CH	1
Q1	CMPA006002F	1

### Notes

- <sup>1</sup>The CMPA006002F is connected to the PCB with 2.0 mil Au bond wires.
- <sup>2</sup>An external bias T is required.

## Product Dimensions CMPA006002F (Package Type – 780019)

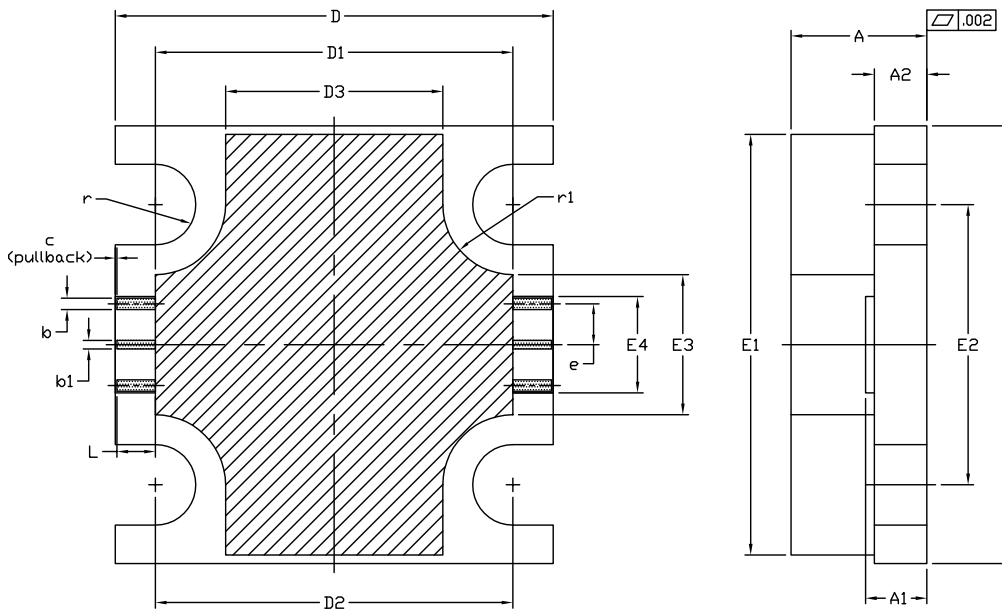

### NOTES:

- DIMENSIONING AND TOLERANCING PER ANSI Y14.5M, 1982.
- CONTROLLING DIMENSION: INCH.
- ADHESIVE FROM LID MAY EXTEND A MAXIMUM OF 0.020" BEYOND EDGE OF LID.
- LID MAY BE MISALIGNED TO THE BODY OF THE PACKAGE BY A MAXIMUM OF 0.006" IN ANY DIRECTION.
- ALL PLATED SURFACES ARE NI/AU

DIM	INCHES		MILLIMETERS		NOTE
	MIN	MAX	MIN	MAX	
A	0.148	0.162	3.76	4.12	–
A1	0.066	0.076	1.67	1.93	–
A2	0.056	0.064	1.42	1.63	–
b	0.013		0.33		x4
b1	0.010		0.25		x2
c	0.002		0.05		x2
D	0.495	0.505	12.57	12.83	–
D1	0.403	0.413	10.23	10.49	–
D2	0.408		10.36		–
D3	0.243	0.253	6.17	6.43	–
E	0.495	0.505	12.57	12.83	–
E1	0.475	0.485	12.06	12.32	–
E2	0.320		8.13		–
E3	0.155	0.165	3.93	4.19	–
E4	0.105	0.115	2.66	2.92	–
e	0.046		1.17		x4
L	0.044		1.12		x6
r	R0.046		R1.17		x4
r1	R0.080		R2.03		x4



## Disclaimer

Specifications are subject to change without notice. Cree, Inc. believes the information contained within this data sheet to be accurate and reliable. However, no responsibility is assumed by Cree for its use or for any infringement of patents or other rights of third parties which may result from its use. No license is granted by implication or otherwise under any patent or patent rights of Cree. Cree makes no warranty, representation or guarantee regarding the suitability of its products for any particular purpose. "Typical" parameters are the average values expected by Cree in large quantities and are provided for information purposes only. These values can and do vary in different applications, and actual performance can vary over time. All operating parameters should be validated by customer's technical experts for each application. Cree products are not designed, intended, or authorized for use as components in applications intended for surgical implant into the body or to support or sustain life, in applications in which the failure of the Cree product could result in personal injury or death, or in applications for the planning, construction, maintenance or direct operation of a nuclear facility. CREE and the CREE logo are registered trademarks of Cree, Inc.

For more information, please contact:

Cree, Inc.  
4600 Silicon Drive  
Durham, North Carolina, USA 27703  
[www.cree.com/wireless](http://www.cree.com/wireless)

Sarah Miller  
Marketing & Export  
Cree, RF Components  
1.919.407.5302

Ryan Baker  
Marketing  
Cree, RF Components  
1.919.407.7816

Tom Dekker  
Sales Director  
Cree, RF Components  
1.919.407.5639





## Стандарт Электрон Связь

Мы молодая и активно развивающаяся компания в области поставок электронных компонентов. Мы поставляем электронные компоненты отечественного и импортного производства напрямую от производителей и с крупнейших складов мира.

Благодаря сотрудничеству с мировыми поставщиками мы осуществляем комплексные и плановые поставки широчайшего спектра электронных компонентов.

Собственная эффективная логистика и склад в обеспечивает надежную поставку продукции в точно указанные сроки по всей России.

Мы осуществляем техническую поддержку нашим клиентам и предпродажную проверку качества продукции. На все поставляемые продукты мы предоставляем гарантию .

Осуществляем поставки продукции под контролем ВП МО РФ на предприятия военно-промышленного комплекса России , а также работаем в рамках 275 ФЗ с открытием отдельных счетов в уполномоченном банке. Система менеджмента качества компании соответствует требованиям ГОСТ ISO 9001.

Минимальные сроки поставки, гибкие цены, неограниченный ассортимент и индивидуальный подход к клиентам являются основой для выстраивания долгосрочного и эффективного сотрудничества с предприятиями радиоэлектронной промышленности, предприятиями ВПК и научно-исследовательскими институтами России.

С нами вы становитесь еще успешнее!

### Наши контакты:

**Телефон:** +7 812 627 14 35

**Электронная почта:** [sales@st-electron.ru](mailto:sales@st-electron.ru)

**Адрес:** 198099, Санкт-Петербург,  
Промышленная ул, дом № 19, литера Н,  
помещение 100-Н Офис 331