

■ Connectivity....for  
Business-Critical Continuity

# *UMC Ultra Miniature Connectors*

*Product Catalog*



**JOHNSON**<sup>®</sup>

  
**EMERSON**<sup>™</sup>  
Network Power

*Emerson's UMC Ultraminiature Coaxial Connectors and Cable Assemblies are the answer for quality, snap-on connections built to meet your cost and performance targets.*

*The UMC cable plugs and jack receptacles offer 2.0mm and 2.5mm maximum mated height options with DC to 6 GHz electrical performance.*

*All parts are RoHS compliant and mate with the Hirose U.FL series connectors.*

## Applications

1. Wireless LAN, Mini-PCI, and Hand-Held RF Devices
2. GSM, GPRS & CDMA Mobile Phones
3. PDA & Notebook Computer
4. GPS
5. Bluetooth
6. Microwave radio and measurement

## Features

1. Excellent cost to performance ratio.
2. Ultra-low profile connections (2.0mm & 2.5mm max. mated height).
3. R/A plug to R/A plug cable assemblies on .81mm, 1.13mm, 1.32mm and 1.37mm cables.
4. UMC cables available in a variety of standard off-the-shelf lengths (from 50mm to 500mm).
5. Between-series cables available with std. & rev. polarity SMA plugs and Blukhead jacks or MMCX plugs on one end of the cable and the UMC plug on the other end.
6. Surface-mount jack receptacles available on tape and reel (2,500 per reel).
7. In-series UMC adapters available to support testing requirements.
8. All cabled plugs and jack receptacles are supplied with gold plated contacts and bodies.
9. UMC connectors mate with Hirose U.FL series connectors.

## Table of Contents

|                                       | PAGE |
|---------------------------------------|------|
| Product Specifications .....          | 2    |
| UMC Cable Assembly .....              | 3    |
| UMC MMCX Profile Cable Assembly ..... | 4    |
| UMC SMA Cable Assembly .....          | 5    |
| UMC SMA RP Cable Assembly .....       | 6    |
| UMC Bare End Cable Assembly .....     | 7    |
| UMC PCB Jack Assembly .....           | 8    |
| UMC Accessories .....                 | 9    |
| Cross Reference .....                 | 10   |

## Product Specifications

|                       |  |
|-----------------------|--|
| Impedance             | 50 $\Omega$ (Nominal)                      |
| Temperature Range     | -40°C to +90°C                             |
| Frequency Rating      | 0-6 GHz                                    |
| VSWR                  | 1.30 max (0-6 GHz)                         |
| Contact Resistance    | 20 m $\Omega$ max. (Center)                |
|                       | 20 m $\Omega$ max. (Outer, for plug)       |
|                       | 10 m $\Omega$ max. (Outer, for receptacle) |
| Withstanding Voltage  | 200 V AC                                   |
| Insulation Resistance | 500 M $\Omega$ min.                        |
| Durability            | 30 cycles                                  |
| Holding Force (min.)  | 0.15 N (Female contact)                    |

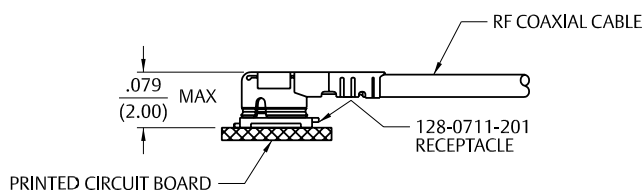

**LP Plug  
(Low Profile Plug)**

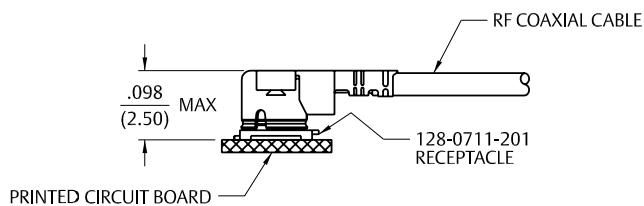

**MP Plug  
(Medium Profile Plug)**

# Ultra Miniature Connectors Cable Assembly

Connectivity...for  
Business-Critical Continuity

## UMC Right Angle Cable Plug to UMC Right Angle Cable Plug



| Part No.     | Teflon Coaxial Cable O.D. | Cable Length | Connector A | Plug Mated Height | Connector B |
|--------------|---------------------------|--------------|-------------|-------------------|-------------|
| 415-0084-050 | 0.81 mm                   | 50 mm        | UMC LP PLUG | 2.0 mm            | UMC LP PLUG |
| 415-0084-100 | 0.81 mm                   | 100 mm       | UMC LP PLUG | 2.0 mm            | UMC LP PLUG |
| 415-0084-150 | 0.81 mm                   | 150 mm       | UMC LP PLUG | 2.0 mm            | UMC LP PLUG |
| 415-0084-200 | 0.81 mm                   | 200 mm       | UMC LP PLUG | 2.0 mm            | UMC LP PLUG |
| 415-0084-250 | 0.81 mm                   | 250 mm       | UMC LP PLUG | 2.0 mm            | UMC LP PLUG |
| 415-0084-300 | 0.81 mm                   | 300 mm       | UMC LP PLUG | 2.0 mm            | UMC LP PLUG |
| 415-0084-500 | 0.81 mm                   | 500 mm       | UMC LP PLUG | 2.0 mm            | UMC LP PLUG |

## UMC Right Angle Cable Plug to UMC Right Angle Cable Plug



| Part No.     | Teflon Coaxial Cable O.D. | Cable Length | Connector A | Plug Mated Height | Connector B |
|--------------|---------------------------|--------------|-------------|-------------------|-------------|
| 415-0085-050 | 0.81 mm                   | 50 mm        | UMC MP PLUG | 2.5 mm            | UMC MP PLUG |
| 415-0085-100 | 0.81 mm                   | 100 mm       | UMC MP PLUG | 2.5 mm            | UMC MP PLUG |
| 415-0085-150 | 0.81 mm                   | 150 mm       | UMC MP PLUG | 2.5 mm            | UMC MP PLUG |
| 415-0085-200 | 0.81 mm                   | 200 mm       | UMC MP PLUG | 2.5 mm            | UMC MP PLUG |
| 415-0085-250 | 0.81 mm                   | 250 mm       | UMC MP PLUG | 2.5 mm            | UMC MP PLUG |
| 415-0085-300 | 0.81 mm                   | 300 mm       | UMC MP PLUG | 2.5 mm            | UMC MP PLUG |
| 415-0085-500 | 0.81 mm                   | 500 mm       | UMC MP PLUG | 2.5 mm            | UMC MP PLUG |
| 415-0086-050 | 1.13 mm                   | 50 mm        | UMC MP PLUG | 2.5 mm            | UMC MP PLUG |
| 415-0086-100 | 1.13 mm                   | 100 mm       | UMC MP PLUG | 2.5 mm            | UMC MP PLUG |
| 415-0086-150 | 1.13 mm                   | 150 mm       | UMC MP PLUG | 2.5 mm            | UMC MP PLUG |
| 415-0086-200 | 1.13 mm                   | 200 mm       | UMC MP PLUG | 2.5 mm            | UMC MP PLUG |
| 415-0086-250 | 1.13 mm                   | 250 mm       | UMC MP PLUG | 2.5 mm            | UMC MP PLUG |
| 415-0086-300 | 1.13 mm                   | 300 mm       | UMC MP PLUG | 2.5 mm            | UMC MP PLUG |
| 415-0086-500 | 1.13 mm                   | 500 mm       | UMC MP PLUG | 2.5 mm            | UMC MP PLUG |
| 415-0087-050 | 1.32 mm                   | 50 mm        | UMC MP PLUG | 2.5 mm            | UMC MP PLUG |
| 415-0087-100 | 1.32 mm                   | 100 mm       | UMC MP PLUG | 2.5 mm            | UMC MP PLUG |
| 415-0087-150 | 1.32 mm                   | 150 mm       | UMC MP PLUG | 2.5 mm            | UMC MP PLUG |
| 415-0087-200 | 1.32 mm                   | 200 mm       | UMC MP PLUG | 2.5 mm            | UMC MP PLUG |
| 415-0087-250 | 1.32 mm                   | 250 mm       | UMC MP PLUG | 2.5 mm            | UMC MP PLUG |
| 415-0087-300 | 1.32 mm                   | 300 mm       | UMC MP PLUG | 2.5 mm            | UMC MP PLUG |
| 415-0087-500 | 1.32 mm                   | 500 mm       | UMC MP PLUG | 2.5 mm            | UMC MP PLUG |
| 415-0088-050 | 1.37 mm                   | 50 mm        | UMC MP PLUG | 2.5 mm            | UMC MP PLUG |
| 415-0088-100 | 1.37 mm                   | 100 mm       | UMC MP PLUG | 2.5 mm            | UMC MP PLUG |
| 415-0088-150 | 1.37 mm                   | 150 mm       | UMC MP PLUG | 2.5 mm            | UMC MP PLUG |
| 415-0088-200 | 1.37 mm                   | 200 mm       | UMC MP PLUG | 2.5 mm            | UMC MP PLUG |
| 415-0088-250 | 1.37 mm                   | 250 mm       | UMC MP PLUG | 2.5 mm            | UMC MP PLUG |
| 415-0088-300 | 1.37 mm                   | 300 mm       | UMC MP PLUG | 2.5 mm            | UMC MP PLUG |
| 415-0088-500 | 1.37 mm                   | 500 mm       | UMC MP PLUG | 2.5 mm            | UMC MP PLUG |

NOTES

1. ID OF CONTACT TO MEET VSWR MATING CHARACTERISTICS AND CONNECTOR DURABILITY WHEN MATED WITH A DIA, .016±.001 MALE CONTACT.
2. MUST MEET THE FORCE TO ENGAGE AND DISENGAGE WHEN MATED WITH PART.

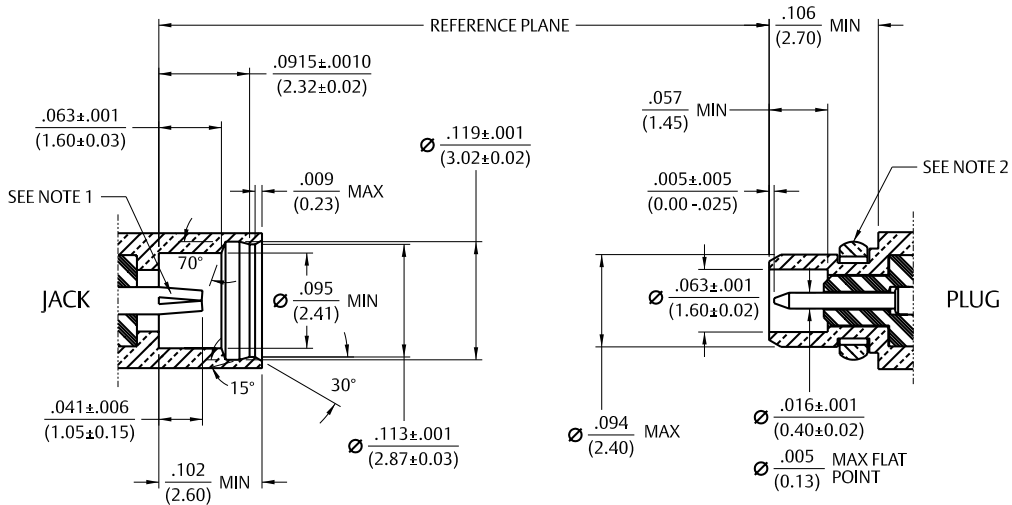

### Low Profile



### UMC Right Angle Cable Plug to MMCX Right Angle Crimp Plug

| Part No.     | Teflon Coaxial Cable O.D. | Cable Length | Connector A | Height | Connector B  |
|--------------|---------------------------|--------------|-------------|--------|--------------|
| 415-0101-150 | 0.81 mm                   | 150 mm       | UMC LP PLUG | 2.0 mm | MMCX RA PLUG |
| 415-0101-250 | 0.81 mm                   | 250 mm       | UMC LP PLUG | 2.0 mm | MMCX RA PLUG |



### Medium Profile



### UMC Right Angle Cable Plug to MMCX Right Angle Crimp Plug

| Part No.     | Teflon Coaxial Cable O.D. | Cable Length | Connector A | Height | Connector B  |
|--------------|---------------------------|--------------|-------------|--------|--------------|
| 415-0102-150 | 0.81 mm                   | 150 mm       | UMC MP PLUG | 2.5 mm | MMCX RA PLUG |
| 415-0102-250 | 0.81 mm                   | 250 mm       | UMC MP PLUG | 2.5 mm | MMCX RA PLUG |
| 415-0103-150 | 1.37 mm                   | 150 mm       | UMC MP PLUG | 2.5 mm | MMCX RA PLUG |
| 415-0103-250 | 1.37 mm                   | 250 mm       | UMC MP PLUG | 2.5 mm | MMCX RA PLUG |

NOTES

1. ID TO MEET VSWR, CONTACT RESISTANCE AND INSERTION WITHDRAWAL FORCES WHEN MATED WITH A DIA, .0355 - .0370 PIN.
2. GASKET IS NOT SUPPLIED WITH BRASS CONNECTORS.

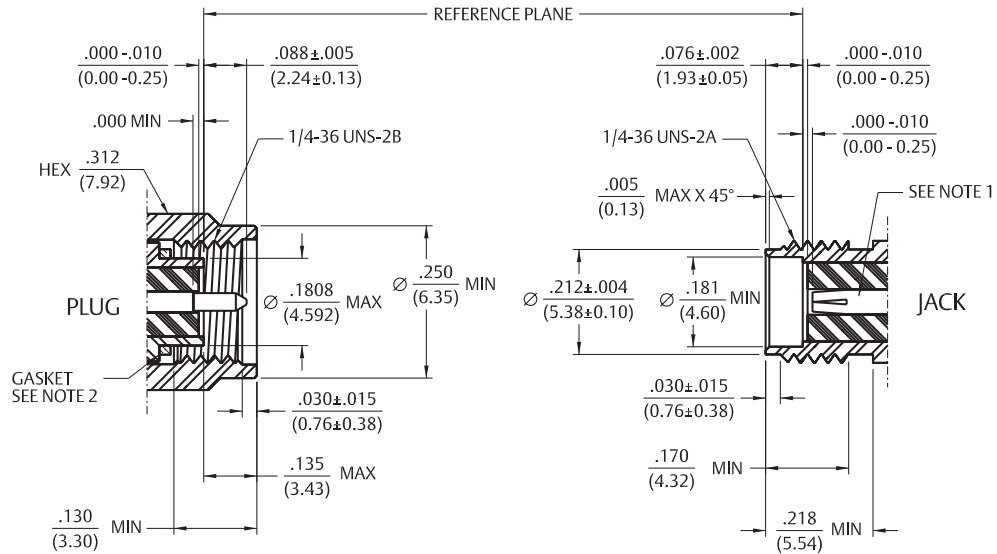

**Low Profile**  
**UMC Right Angle Cable Plug to SMA Straight Crimp Plug**



| Part No.     | Teflon Coaxial Cable O.D. | Cable Length | Connector A | Height | Connector B         |
|--------------|---------------------------|--------------|-------------|--------|---------------------|
| 415-0089-150 | 0.81 mm                   | 150 mm       | UMC LP PLUG | 2.0 mm | SMA STR. CRIMP PLUG |
| 415-0089-250 | 0.81 mm                   | 250 mm       | UMC LP PLUG | 2.0 mm | SMA STR. CRIMP PLUG |



**Medium Profile**  
**UMC Right Angle Cable Plug to SMA Straight Crimp Plug**



| Part No.     | Teflon Coaxial Cable O.D. | Cable Length | Connector A | Height | Connector B         |
|--------------|---------------------------|--------------|-------------|--------|---------------------|
| 415-0090-150 | 0.81 mm                   | 150 mm       | UMC MP PLUG | 2.5 mm | SMA STR. CRIMP PLUG |
| 415-0090-250 | 0.81 mm                   | 250 mm       | UMC MP PLUG | 2.5 mm | SMA STR. CRIMP PLUG |
| 415-0091-150 | 1.37 mm                   | 150 mm       | UMC MP PLUG | 2.5 mm | SMA STR. CRIMP PLUG |
| 415-0091-250 | 1.37 mm                   | 250 mm       | UMC MP PLUG | 2.5 mm | SMA STR. CRIMP PLUG |

**Low Profile**  
**UMC Right Angle Cable Plug to SMA Straight Crimp Bulkhead Jack**



| Part No.     | Teflon Coaxial Cable O.D. | Cable Length | Connector A | Height | Connector B            |
|--------------|---------------------------|--------------|-------------|--------|------------------------|
| 415-0095-150 | 0.81 mm                   | 150 mm       | UMC LP PLUG | 2.0 mm | SMA STR CR. BKHD. JACK |
| 415-0095-250 | 0.81 mm                   | 250 mm       | UMC LP PLUG | 2.0 mm | SMA STR CR. BKHD. JACK |



**Medium Profile**  
**UMC Right Angle Cable Plug to SMA Straight Crimp Bulkhead Jack**



| Part No.     | Teflon Coaxial Cable O.D. | Cable Length | Connector A | Height | Connector B            |
|--------------|---------------------------|--------------|-------------|--------|------------------------|
| 415-0096-150 | 0.81 mm                   | 150 mm       | UMC MP PLUG | 2.5 mm | SMA STR CR. BKHD. JACK |
| 415-0096-250 | 0.81 mm                   | 250 mm       | UMC MP PLUG | 2.5 mm | SMA STR CR. BKHD. JACK |
| 415-0097-150 | 1.37 mm                   | 150 mm       | UMC MP PLUG | 2.5 mm | SMA STR CR. BKHD. JACK |
| 415-0097-250 | 1.37 mm                   | 250 mm       | UMC MP PLUG | 2.5 mm | SMA STR CR. BKHD. JACK |

# Ultra Miniature Connectors SMA Reverse Polarity Cable Assembly

NOTES

1. ID TO MEET VSWR, CONTACT RESISTANCE AND INSERTION WITHDRAWAL FORCES WHEN MATED WITH A DIA. .0355 - .0370 PIN.

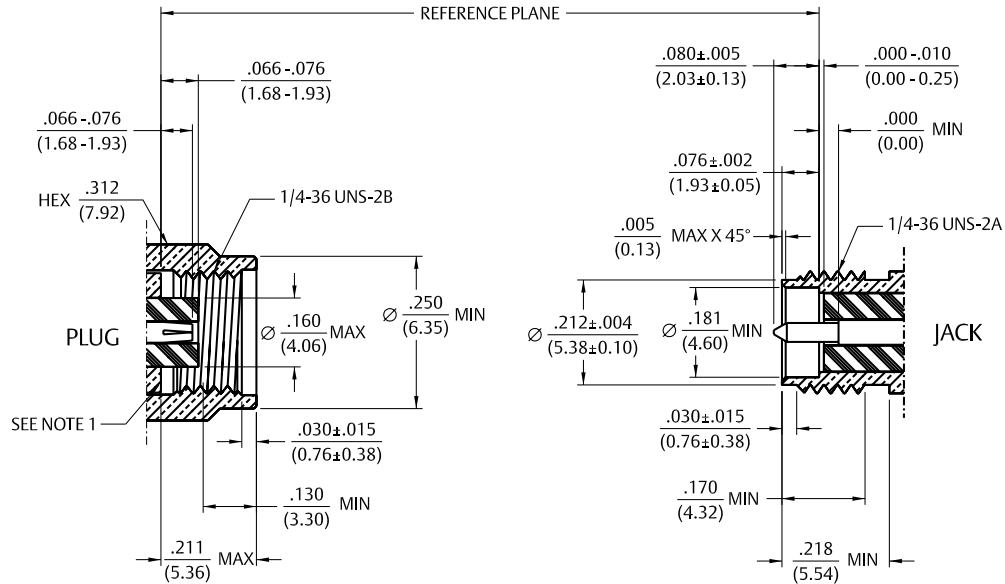

**Low Profile**



**UMC Right Angle Cable Plug to SMA Straight Crimp Reverse Polarity Plug**

| Part No.     | Teflon Coaxial Cable O.D. | Cable Length | Connector A | Height | Connector B            |
|--------------|---------------------------|--------------|-------------|--------|------------------------|
| 415-0092-150 | 0.81 mm                   | 150 mm       | UMC LP PLUG | 2.0 mm | SMA STR. CRIMP RP PLUG |
| 415-0092-250 | 0.81 mm                   | 250 mm       | UMC LP PLUG | 2.0 mm | SMA STR. CRIMP RP PLUG |



**Medium Profile**



**UMC Right Angle Cable Plug to SMA Straight Crimp Reverse Polarity Plug**

| Part No.     | Teflon Coaxial Cable O.D. | Cable Length | Connector A | Height | Connector B            |
|--------------|---------------------------|--------------|-------------|--------|------------------------|
| 415-0093-150 | 0.81 mm                   | 150 mm       | UMC MP PLUG | 2.5 mm | SMA STR. CRIMP RP PLUG |
| 415-0093-250 | 0.81 mm                   | 250 mm       | UMC MP PLUG | 2.5 mm | SMA STR. CRIMP RP PLUG |
| 415-0094-150 | 1.37 mm                   | 150 mm       | UMC MP PLUG | 2.5 mm | SMA STR. CRIMP RP PLUG |
| 415-0094-250 | 1.37 mm                   | 250 mm       | UMC MP PLUG | 2.5 mm | SMA STR. CRIMP RP PLUG |

**Low Profile**



**UMC Right Angle Cable Plug to SMA Straight Crimp Bulkhead Rev. Polarity Jack**

| Part No.     | Teflon Coaxial Cable O.D. | Cable Length | Connector A | Height | Connector B               |
|--------------|---------------------------|--------------|-------------|--------|---------------------------|
| 415-0098-150 | 0.81 mm                   | 150 mm       | UMC LP PLUG | 2.0 mm | SMA STR CR. BKHD. RP JACK |
| 415-0098-250 | 0.81 mm                   | 250 mm       | UMC LP PLUG | 2.0 mm | SMA STR CR. BKHD. RP JACK |



**Medium Profile**



**UMC Right Angle Cable Plug to SMA Straight Crimp Bulkhead Rev. Polarity Jack**

| Part No.     | Teflon Coaxial Cable O.D. | Cable Length | Connector A | Height | Connector B               |
|--------------|---------------------------|--------------|-------------|--------|---------------------------|
| 415-0099-150 | 0.81 mm                   | 150 mm       | UMC LP PLUG | 2.5 mm | SMA STR CR. BKHD. RP JACK |
| 415-0099-250 | 0.81 mm                   | 250 mm       | UMC LP PLUG | 2.5 mm | SMA STR CR. BKHD. RP JACK |
| 415-0100-150 | 1.37 mm                   | 150 mm       | UMC MP PLUG | 2.5 mm | SMA STR CR. BKHD. RP JACK |
| 415-0100-250 | 1.37 mm                   | 250 mm       | UMC MP PLUG | 2.5 mm | SMA STR CR. BKHD. RP JACK |

# Ultra Miniature Connectors SMA Bare Ends Assembly

Connectivity...for  
Business-Critical Continuity

## 0.81 mm Coaxial Cable

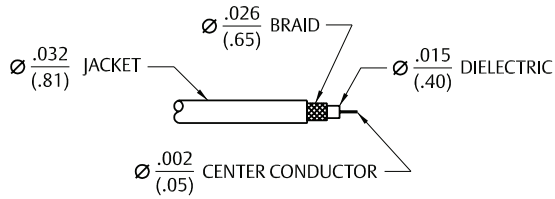

## 1.32 mm Coaxial Cable

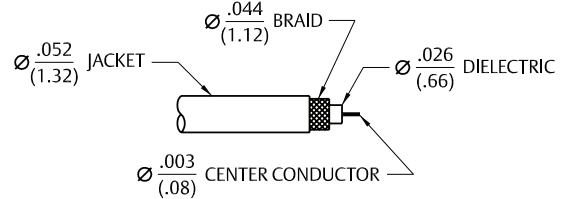

## 1.13 mm Coaxial Cable

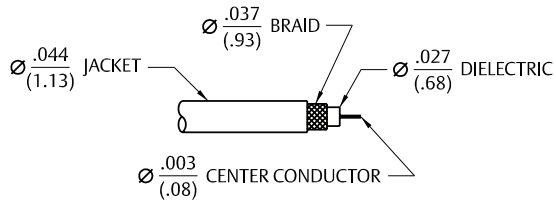

## 1.37 mm Coaxial Cable

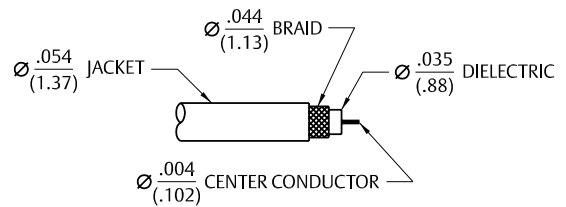

### Low Profile UMC Right Angle Cable Plug to Bare End



| Part No.     | Teflon Coaxial Cable O.D. | Cable Length | Connector A | Height | Connector B |
|--------------|---------------------------|--------------|-------------|--------|-------------|
| 415-0104-150 | .81 mm                    | 150 mm       | UMC LP PLUG | 2.0 mm | BARE END    |
| 415-0104-250 | .81 mm                    | 250 mm       | UMC LP PLUG | 2.0 mm | BARE END    |

### Medium Profile UMC Right Angle Cable Plug to Bare End



| Part No.     | Teflon Coaxial Cable O.D. | Cable Length | Connector A | Height | Connector B |
|--------------|---------------------------|--------------|-------------|--------|-------------|
| 415-0105-150 | .81 mm                    | 150 mm       | UMC MP PLUG | 2.5 mm | BARE END    |
| 415-0105-250 | .81 mm                    | 250 mm       | UMC MP PLUG | 2.5 mm | BARE END    |
| 415-0106-150 | 1.13 mm                   | 150 mm       | UMC MP PLUG | 2.5 mm | BARE END    |
| 415-0106-250 | 1.13 mm                   | 250 mm       | UMC MP PLUG | 2.5 mm | BARE END    |
| 415-0107-150 | 1.32 mm                   | 150 mm       | UMC MP PLUG | 2.5 mm | BARE END    |
| 415-0107-250 | 1.32 mm                   | 250 mm       | UMC MP PLUG | 2.5 mm | BARE END    |
| 415-0108-150 | 1.37 mm                   | 150 mm       | UMC MP PLUG | 2.5 mm | BARE END    |
| 415-0108-250 | 1.37 mm                   | 250 mm       | UMC MP PLUG | 2.5 mm | BARE END    |



## Straight Jack Receptacle - Surface Mount

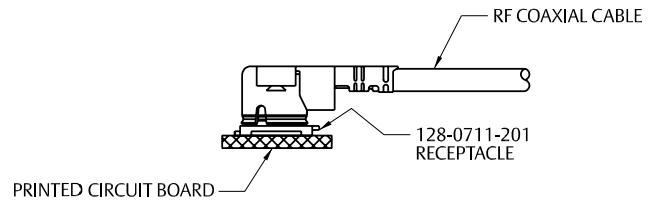

| Part No.     | Tape & Reel |
|--------------|-------------|
| 128-0711-201 | 2,500/REEL  |

## Tape and Reel

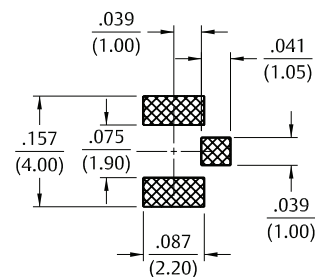
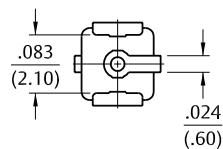
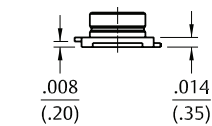
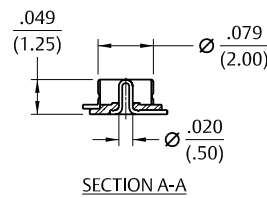
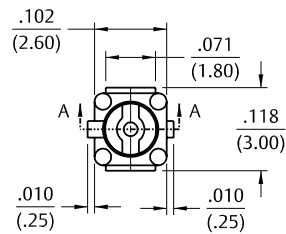
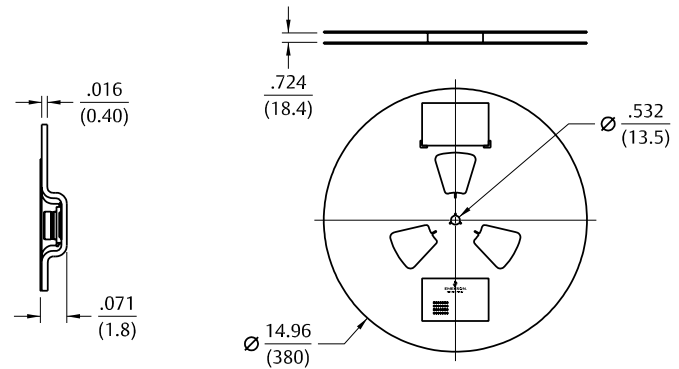
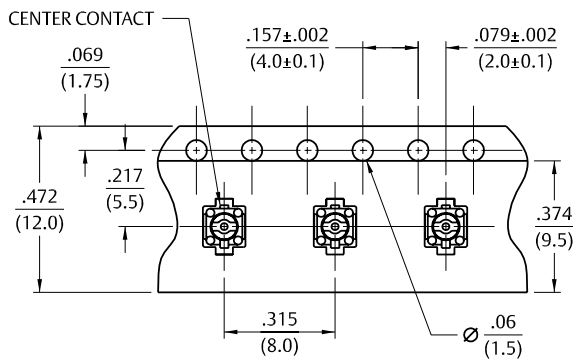

RECOMMENDED PCB PATTERN

## SMA Conversion Adapter for Mating UMC Plugs (SMA Plug to UMC Jack)



**Part No.**

134-1019-361

Fig. 1

## UMC Separation Key

FOR EXTRACTION  
FROM A COUPLED CONDITION.



**Part No.**

128-0000-901

## SMA Conversion Adapter for Surface Mt. Jack Receptacle 128-0711-201 (SMA Jack to UMC Plug)



**Part No.**

134-1019-371

Fig. 2

## Inspection Tool for Cable Assy.



**Part No.**

134-1019-381

Fig. 3

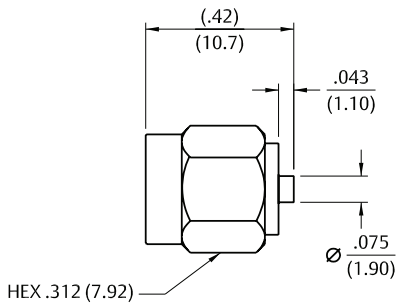

Fig. 1

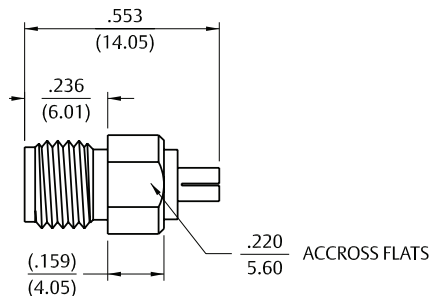

Fig. 2

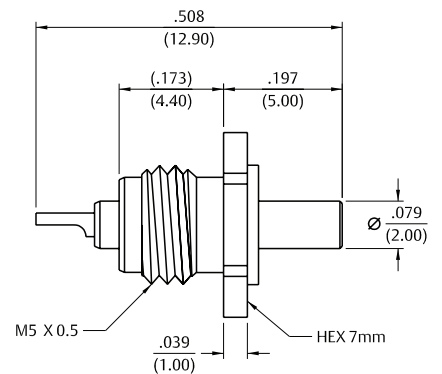

Fig. 3

**JOHNSON P/N**

128-0711-201  
415-0084-050  
415-0084-100  
415-0084-150  
415-0084-200  
415-0084-250  
415-0084-300  
415-0084-500  
415-0085-050  
415-0085-100  
415-0085-150  
415-0085-200  
415-0085-250  
415-0085-300  
415-0085-300  
415-0086-050  
415-0086-100  
415-0086-150  
415-0086-200  
415-0086-250  
415-0086-300  
415-0086-500  
415-0087-050

**HIROSE**

U.FL-R-SMT(10)  
U.FL-2LP(V)-04N1-A-50  
U.FL-2LP(V)-04N1-A-100  
U.FL-2LP(V)-04N1-A-150  
U.FL-2LP(V)-04N1-A-200  
U.FL-2LP(V)-04N1-A-250  
U.FL-2LP(V)-04N1-A-300  
U.FL-2LP(V)-04N1-A-500  
U.FL-2LP-04N2-A-50  
U.FL-2LP-04N2-A-100  
U.FL-2LP-04N2-A-150  
U.FL-2LP-04N2-A-200  
U.FL-2LP-04N2-A-250  
U.FL-2LP-04N2-A-300  
U.FL-2LP-04N2-A-500  
U.FL-2LP-068N2-A-50  
U.FL-2LP-068N2-A-100  
U.FL-2LP-068N2-A-150  
U.FL-2LP-068N2-A-200  
U.FL-2LP-068N2-A-250  
U.FL-2LP-068N2-A-300  
U.FL-2LP-068N2-A-500  
U.FL-2LP-066J2-A-50

**JOHNSON P/N**

415-0087-100  
415-0087-150  
415-0087-200  
415-0087-250  
415-0087-300  
415-0087-500  
415-0088-050  
415-0088-100  
415-0088-150  
415-0088-200  
415-0088-250  
415-0088-300  
415-0088-500  
415-0104-150  
415-0104-250  
415-0105-150  
415-0105-250  
415-0106-150  
415-0106-250  
415-0107-150  
415-0107-250  
415-0108-150  
415-0108-250

**HIROSE**

U.FL-2LP-066J2-A-100  
U.FL-2LP-066J2-A-150  
U.FL-2LP-066J2-A-200  
U.FL-2LP-066J2-A-250  
U.FL-2LP-066J2-A-300  
U.FL-2LP-066J2-A-500  
U.FL-2LP-088K2T-A-50  
U.FL-2LP-088K2T-A-100  
U.FL-2LP-088K2T-A-150  
U.FL-2LP-088K2T-A-200  
U.FL-2LP-088K2T-A-250  
U.FL-2LP-088K2T-A-300  
U.FL-2LP-088K2T-A-500  
U.FL-LP(V)-04N1-A-150  
U.FL-LP(V)-04N1-A-250  
U.FL-LP-04N2-A-150  
U.FL-LP-04N2-A-250  
U.FL-LP-068N2-A-150  
U.FL-LP-068N2-A-250  
U.FL-LP-066J2-A-150  
U.FL-LP-066J2-A-250  
U.FL-LP-088K2T-A-150  
U.FL-LP-088K2T-A-250

**UMC Family : UMC MP, LP, ULP**  
**Competition with other Supplier's Product**

| Model Name                          | Emerson / Johnson  |               |               | HIROSE                          |                |               |
|-------------------------------------|--|---------------|---------------|---------------------------------|----------------|---------------|
|                                     | UMC MP   | UMC LP        | UMC ULP       | U.FL-LP-040/066                 | U.FL-LP(V)-040 | W.FL-LP-040   |
| Mated Height (Max.)                 | 2.5/2.7mm  | 2.1mm         | 1.6mm         | 2.5mm                           | 2.0mm          | 1.55mm        |
| Termination Style                   | Mechanical Termination   |               |               | Soldering                       |                |               |
| Plating of Shell                    | Gold   | Gold          | Gold          | Silver                          | Silver         | Silver        |
| Plating of Contact                  | Gold   | Gold          | Gold          | Gold                            | Gold           | Gold          |
| Applicable Coaxial Cable (Diameter) | AWG30(1.37mm)<br>AWG32(1.32mm)<br>AWG32(1.13mm)<br>AWG36(0.81mm) | AWG36(0.81mm) | AWG36(0.81mm) | AWG32(1.32mm)<br>AWG36 (0.81mm) | AWG36(0.81mm)  | AWG36(0.81mm) |
| Frequencies                         | DC to 6GHz   |               |               | DC to 6GHz                      |                |               |

**UMC Compatibility Table Johnson Vs HIROSE**

| UMC Family     | Mated Height (mm) | AWG (O.D. mm) | Emerson / Johnson          |              | HIROSE                     |                  |
|----------------|-------------------|---------------|----------------------------|--------------|----------------------------|------------------|
|                |                   |               | Plating (Contact / Ground) | Part No.     | Plating (Contact / Ground) | Product No.      |
| UMC Receptacle | 2.7/2.5/2.1       | N/A           | Gold                       | 128-0711-201 | Gold/Silver                | U.FL-R-SMT (10)  |
| UMC MP Plug    | 2.5               | 30 (1.37)     | Gold                       | 415-0088-xxx | Gold/Silver                | U.FL-LP-088      |
| UMC MP Plug    | 2.7/2.5           | 32 (1.32)     | Gold                       | 415-0087-xxx | Gold/Silver                | U.FL-LP-066      |
|                |                   | 32 (1.13)     | Gold                       | 415-0086-xxx | Gold/Silver                | U.FL-LP-066      |
|                |                   | 36 (0.81)     | Gold                       | 415-0085-xxx | Gold/Silver                | U.FL-LP-040      |
| UMC LP Plug    | 2.1               | 36 (0.81)     | Gold                       | 415-0084-xxx | Gold/Silver                | U.FL-LP(V)-040   |
| UMC ULP Plug   | 1.6               | N/A           | Gold                       | 415-0109-xxx | Gold/Silver                | CL-331-0482-6-10 |

## Emerson Network Power Connectivity Solutions

**Johnson**  
299 Johnson Avenue  
Waseca, MN 56093  
USA

**Tel: 800.247.8256**  
**Fax: 507.833.6287**

**[www.EmersonNetworkPower.com/Connectivity](http://www.EmersonNetworkPower.com/Connectivity)**

## About Emerson Network Power Connectivity Solutions

Emerson Network Power Connectivity Solutions, an Emerson business, serves the needs of wireless communications, telephony and data networks, CATV, security systems, health care and industrial facilities with a full spectrum of RF and Microwave connectivity products. For more information, visit [www.EmersonNetworkPower.com/Connectivity](http://www.EmersonNetworkPower.com/Connectivity).

## About Emerson

Emerson (NYSE: EMR), based in St. Louis, is a global leader in bringing technology and engineering together to provide innovative solutions to customers through its network power, process management, industrial automation, climate technologies, and appliance and tools businesses. Sales in fiscal 2006 were \$20.1 billion. For more information, visit [www.gotoemerson.com](http://www.gotoemerson.com).

## Emerson Network Power.

The global leader in enabling business-critical continuity.

- AC Power Systems
- Embedded Power
- Outside Plant
- Connectivity
- Inbound Power
- Precision Cooling
- DC Power Systems
- Integrated Cabinet Solutions
- Site Monitoring and Services

**[www.EmersonNetworkPower.com](http://www.EmersonNetworkPower.com)**



## Стандарт Электрон Связь

Мы молодая и активно развивающаяся компания в области поставок электронных компонентов. Мы поставляем электронные компоненты отечественного и импортного производства напрямую от производителей и с крупнейших складов мира.

Благодаря сотрудничеству с мировыми поставщиками мы осуществляем комплексные и плановые поставки широчайшего спектра электронных компонентов.

Собственная эффективная логистика и склад в обеспечивает надежную поставку продукции в точно указанные сроки по всей России.

Мы осуществляем техническую поддержку нашим клиентам и предпродажную проверку качества продукции. На все поставляемые продукты мы предоставляем гарантию .

Осуществляем поставки продукции под контролем ВП МО РФ на предприятия военно-промышленного комплекса России , а также работаем в рамках 275 ФЗ с открытием отдельных счетов в уполномоченном банке. Система менеджмента качества компании соответствует требованиям ГОСТ ISO 9001.

Минимальные сроки поставки, гибкие цены, неограниченный ассортимент и индивидуальный подход к клиентам являются основой для выстраивания долгосрочного и эффективного сотрудничества с предприятиями радиоэлектронной промышленности, предприятиями ВПК и научно-исследовательскими институтами России.

С нами вы становитесь еще успешнее!

### Наши контакты:

**Телефон:** +7 812 627 14 35

**Электронная почта:** [sales@st-electron.ru](mailto:sales@st-electron.ru)

**Адрес:** 198099, Санкт-Петербург,  
Промышленная ул, дом № 19, литера Н,  
помещение 100-Н Офис 331