

# miriac SBC-S32V

User Manual

V 1.1

# Table of Contents

|          |  |           |          |  |           |
|----------|--|-----------|----------|--|-----------|
| <b>1</b> | <b>General Notes.....</b>                              | <b>4</b>  | 4.15.6   | Power Distribution .....                     | 29        |
| 1.1      | Warranty.....  | 4         | 4.15.7   | MIPI Power .....                             | 30        |
| 1.2      | Links.....   | 4         | 4.15.8   | Power Up.....                                | 31        |
| 1.3      | Liability .....  | 4         | 4.16     | Reset Structure.....                         | 32        |
| 1.4      | Offer to Provide Source Code of Certain Software ..... | 5         | <b>5</b> | <b>System Core, Boot Configuration .....</b> | <b>33</b> |
| 1.5      | Symbols, Conventions and Abbreviations .....           | 6         | 5.1      | Processor NXP S32V234 .....                  | 33        |
| 1.5.1    | Symbols .....  | 6         | 5.2      | Boot Mode Configuration .....                | 34        |
| 1.5.2    | Conventions .....                                      | 6         | 5.3      | Boot Mode Switch.....                        | 35        |
| <b>2</b> | <b>Introduction .....</b>                              | <b>7</b>  | 5.4      | Power Up Configuration.....                  | 36        |
| 2.1      | Safety and Handling Precautions .....                  | 7         | 5.5      | MCU programming Port.....                    | 37        |
| 2.2      | Short Description.....                                 | 8         | 5.5.1    | MCU Pinout .....                             | 39        |
| 2.3      | Shipping List.....                                     | 8         | <b>6</b> | <b>MPX-Module .....</b>                      | <b>41</b> |
| <b>3</b> | <b>Quick Start Guide .....</b>                         | <b>9</b>  | 6.1      | Mounting/Unmounting .....                    | 42        |
| 3.1      | Prerequisites .....                                    | 9         | 6.2      | DRAM .....                                   | 44        |
| 3.1.1    | Minimum Requirements .....                             | 9         | 6.3      | eMMC .....                                   | 45        |
| 3.1.2    | Recommended Items .....                                | 9         | 6.4      | Leds.....                                    | 45        |
| 3.2      | Board Preparation and Power-Up .....                   | 10        | 6.5      | Switches .....                               | 46        |
| 3.3      | Operation .....  | 12        | 6.6      | Module Connector .....                       | 47        |
| 3.3.1    | U-Boot Startup.....                                    | 12        | 6.7      | Module/Carrier Connections .....             | 48        |
| <b>4</b> | <b>System Description.....</b>                         | <b>13</b> | <b>7</b> | <b>JTAG Chain .....</b>                      | <b>55</b> |
| 4.1      | Block Diagram CRX-S32V Carrier.....                    | 13        | 7.1.1    | JTAG Devices.....                            | 55        |
| 4.2      | Block Diagram MPX-S32V Module.....                     | 13        | 7.1.2    | JTAG Connector.....                          | 55        |
| 4.3      | Feature Overview .....                                 | 14        | 7.1.3    | JTAG Connector Pinout.....                   | 56        |
| 4.4      | Mechanical Dimensions .....                            | 17        | <b>8</b> | <b>I<sup>2</sup>C Structure.....</b>         | <b>57</b> |
| 4.4.1    | MPX-S32V Module.....                                   | 17        | 8.1.1    | Bus Map .....                                | 57        |
| 4.4.2    | CRX-S32V Carrier.....                                  | 18        | 8.1.2    | I <sup>2</sup> C Devices .....               | 58        |
| 4.5      | Carrier Board Layout – Module Side .....               | 19        | 8.1.3    | Digital Visual Interface.....                | 58        |
| 4.6      | Carrier Board Layout – Non-Module Side ...             | 20        | <b>9</b> | <b>Peripherals .....</b>                     | <b>59</b> |
| 4.7      | Carrier Power Button Side View .....                   | 21        | 9.1      | HDMI .....                                   | 59        |
| 4.8      | Carrier Power Plug Side View .....                     | 21        | 9.1.1    | DDC Function .....                           | 59        |
| 4.9      | Carrier Bottom Side View .....                         | 21        | 9.1.2    | HDMI Connector.....                          | 60        |
| 4.10     | Carrier Top Side View .....                            | 21        | 9.2      | LAN Connection .....                         | 61        |
| 4.11     | Module Top Side .....                                  | 22        | 9.3      | PCIe Interface.....                          | 62        |
| 4.12     | Module Bottom Side .....                               | 22        | 9.3.1    | Power Connector PWE1.....                    | 62        |
| 4.14     | System Environment .....                               | 23        | 9.3.2    | The Mini-PCIe Slot .....                     | 63        |
| 4.14.1   | Temperature Ratings.....                               | 23        | 9.4      | MIPI CSI Interface .....                     | 64        |
| 4.14.2   | Power Dissipation.....                                 | 25        | 9.4.1    | MIPI Connectors.....                         | 65        |
| 4.15     | Power Supply .....                                     | 26        | 9.4.2    | MIPIA Connector .....                        | 66        |
| 4.15.1   | Input Supply Rating.....                               | 26        | 9.4.3    | MIPIB Connector .....                        | 67        |
| 4.15.2   | Input Power Connector.....                             | 26        | 9.5      | MicroSD Card Slot.....                       | 68        |
| 4.15.3   | Input Power Switch.....                                | 27        | 9.6      | UART .....                                   | 70        |
| 4.15.4   | Fuses .....  | 28        | 9.6.1    | UART1 .....                                  | 70        |
| 4.15.5   | Power Supply Structure.....                            | 28        | 9.6.2    | UART2.....                                   | 70        |
|          |  |           | 9.7      | CAN .....                                    | 71        |

|       |                   |    |           |                       |           |
|-------|-------------------|----|-----------|-----------------------|-----------|
| 9.7.1 | CAN0.....         | 71 | <b>10</b> | <b>Appendix .....</b> | <b>77</b> |
| 9.7.2 | CAN1.....         | 71 | 10.1      | Acronyms.....         | 77        |
| 9.7.3 | Termination ..... | 72 | 10.2      | Table of Figures..... | 78        |
| 9.8   | LEDs .....        | 73 | 10.3      | Table of Tables.....  | 80        |
| 9.9   | Switches .....    | 74 | <b>11</b> | <b>History .....</b>  | <b>81</b> |
| 9.10  | Jumpers .....     | 76 |           |                       |           |

# 1 General Notes

## Copyright MicroSys Electronics GmbH, January 2017

All rights reserved. All rights in any information which appears in this document belong to MicroSys Electronics GmbH or our licensors. You may copy the information in this manual for your personal, non-commercial use.

Copyrighted products are not explicitly indicated in this manual. The absence of the copyright (©) and trademark (TM or ®) symbols does not imply that a product is not protected. Additionally, registered patents and trademarks are similarly not expressly indicated in this manual.

## 1.1 Warranty

To the extent permissible by applicable law all information in this document is provided without warranty of any kind, whether expressed or implied, including but not limited to any implied warranty of satisfactory quality or fitness for a particular purpose, or of non-infringement of any third party's rights. We try to keep this document accurate and up-to-date but we do not make any warranty or representation about such matters. In particular we assume no liability or responsibility for any errors or omissions in this document.

MicroSys Electronics GmbH neither gives any guarantee nor accepts any liability whatsoever for consequential damages resulting from the use of this manual or its associated product.

MicroSys Electronics GmbH further reserves the right to alter the layout and/or design of the hardware without prior notification and accepts no liability for doing so.

## 1.2 Links

We make no warranty about any other sites that are linked to or from this document, whether we authorize such links or not.

## 1.3 Liability

To the extent permissible by applicable law, in no circumstance, including (but not limited to) negligence, shall we be liable for your reliance on any information in this document, nor shall we be liable for any direct, incidental, special, consequential, indirect or punitive damages nor any loss of profit that result from the use of, or the inability to use, this document or any material on any site linked to this document even if we have been advised of the possibility of such damage. In no event shall our liability to you for all damages, losses and causes of action whatsoever, whether in contract, tort (including but not limited to negligence) or otherwise exceed the amount, if any, paid by you to us for gaining access to this document.

MicroSys Electronics GmbH  
Muehlweg 1  
D-82054 Sauerlach  
Germany

Phone: +49 8104 801-0  
Fax: +49 8104 801-110

## 1.4 Offer to Provide Source Code of Certain Software

This product contains copyrighted software that is licensed under the General Public License (“GPL”) and under the Lesser General Public License Version (“LGPL”). The GPL and LGPL licensed code in this product is distributed without any warranty. Copies of these licenses are included in this product.

You may obtain the complete corresponding source code (as defined in the GPL) for the GPL Software, and/or the complete corresponding source code of the LGPL Software (with the complete machine-readable “work that uses the Library”) for a period of three years after our last shipment of the product including the GPL Software and/or LGPL Software, which will be no earlier than December 1, 2010, for the cost of reproduction and shipment, which is dependent on the preferred carrier and the location where you want to have it shipped to, by sending a request to:

MicroSys Electronics GmbH  
Muehlweg 1  
D-82054 Sauerlach  
Germany

In your request please provide the product name and version for which you wish to obtain the corresponding source code and your contact details so that we can coordinate the terms and cost of shipment with you.

The source code will be distributed WITHOUT ANY WARRANTY and licensed under the same license as the corresponding binary/object code.

This offer is valid to anyone in receipt of this information.

MicroSys Electronics GmbH is eager to duly provide complete source code as required under various Free Open Source Software licenses. If, however you encounter any problems in obtaining the full corresponding source code we would be much obliged if you give us a notification to the email address [gpl@microsys.de](mailto:gpl@microsys.de), stating the product and describing the problem (please do NOT send large attachments such as source code archives etc. to this email address)

## 1.5 Symbols, Conventions and Abbreviations

### 1.5.1 Symbols

Throughout this document, the following symbols will be used:



Information marked with this symbol **MUST** be obeyed to avoid the risk of severe injury, health danger, or major destruction of the unit and its environment



Information marked with this symbol **MUST** be obeyed to avoid the risk of possible injury, permanent damage or malfunction of the unit.



Information marked with this symbol gives important hints upon details of this manual, or in order to get the best use out of the product and its features.

Table 1 Symbols

### 1.5.2 Conventions

| Symbol  | explanation  |
|---------|--|
| #       | denotes a low active signal  |
| ←       | denotes the signal flow in the shown direction   |
| →       | denotes the signal flow in the shown direction   |
| ↔       | denotes the signal flow in both directions   |
| →       | denotes the signal flow in the shown direction with additional logic / additional ICs in the signal path |
| I/O     | denotes a bidirectional pin  |
| Input   | denotes an input pin   |
| matched | denotes the according signal to be routed impedance controlled and length matched                        |
| Output  | denotes an output pin  |
| Pin 1   | refers to the numeric pin of a component package   |
| Pin a1  | refers to the array position of a pin within a component package   |
| XXX-    | denotes the negative signal of a differential pair   |
| XXX+    | denotes the positive signal of a differential pair   |
| XXX     | denotes an optional not mounted or fitted part   |

Table 2 Conventions

## 2 Introduction

Thank you for choosing the MicroSys SBC-S32V Single Board Computer system. This manual should help you to get the best performance and details out all of its features.

### 2.1 Safety and Handling Precautions



**ALWAYS** use the correct type and polarity of the power supply!

**DO NOT** exceed the rated maximum values for the power supply! This may result in severe permanent damage to the unit, as well as possible serious injury.

**ALWAYS** keep the unit dry, clean and free of foreign objects. Otherwise, irreparable damage may occur.



Parts of the unit may become hot during operation. Take care not to touch any parts of the circuitry during operation to avoid burns, and operate the unit in a well-ventilated location. Provide an appropriate cooling solution as required.



**ALWAYS** take care of ESD-safe handling!

Many pins on external connectors are directly connected to the CPU or other ESD sensitive devices.

**Make or break ANY connections ONLY** while the unit is switched OFF.

Otherwise, permanent damage to the unit may occur, which is not covered by warranty.



There is no separate SHIELD connection.

All the metal sheaths of shielded connectors are connected to GND.

Also, all mounting holes of the carrier board are connected to GND.

The module's mounting holes are not connected to GND. Take this into account when handling and mounting the unit.

Table 3 Safety and Handling Precautions

## 2.2 Short Description

The SBC-S32V is a small computer system consisting of

- the MPX-S32V module, based on NXP's S32V234 vision processing MPU
- the CRX-S32V carrier board.

It targets both

- evaluation of the MPX-S32V SOM
- direct usage as an industrial ADAS computing solution

This document provides you an overview on the system devices, connectors and functions, and how to take the first steps on the initial setup.

## 2.3 Shipping List

The SBC-S32V EvalKit package contains the following items:

- The SBC-S32V system, mounted with cooling solution
- Power Supply 12V DC stabilized / 2 A
- Micro-SD-Card with U-Boot and root file system



## 3 Quick Start Guide

### 3.1 Prerequisites



---

**Always make sure to handle the SBC-S32V unit ESD-safe! Otherwise, the unit may suffer permanent damage. However, do not place the unit directly flat on a metal surface, as this may result in short circuits and damage to the board.**

---

At first time operation unpack the unit and make sure that is clean and free of visible damage or foreign objects.

#### 3.1.1 Minimum Requirements

To operate the board, you will at least need the following items:

- an adequate power supply, delivering 12V DC (stabilized) / 2 A min.
- an USB cable (type A – micro B) adapted to connector USB
- a serial terminal, such as a PC with an USB port running a terminal Software (e.g. TeraTerm, HyperTerminal, putty, Kermit...), or else a hardware serial console. **Choose the following parameters:**
  - (a) **115200 Bd**
  - (b) **8 Data bits**
  - (c) **No parity**
  - (d) **1 Stop Bit**

#### 3.1.2 Recommended Items

The following items are not absolutely necessary, but strongly recommended for practical operation and development purposes:

- Network connection via LAN port (RJ45) to your local network installation
- TFTP server available for downloading within the network (Hint: may run on the same PC as the serial Terminal)
- SD card as mass storage and/or boot media

### 3.2 Board Preparation and Power-Up

- Make sure the switch BOOT, located on the CRX-S32V carrier board, is set properly in order to select the correct boot source and board configuration. For more details see chapter 5.3 Boot Mode Switch

Figure 1 BOOT Switch

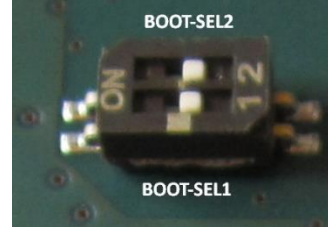

- Make sure the switch BMD, located on the MPX-S32V module, is set properly in order to select the correct boot source. For more details see chapter 5.2 Boot Mode Configuration

Figure 2: BMD Switch

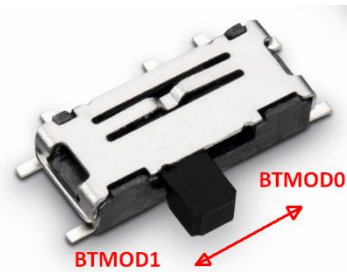

- Make sure the switch GPU, located on the MPX-S32V module, is set properly in order to select the correct GPU supply. For more details see chapter 6.5 Switches

Figure 3: GPU Switch

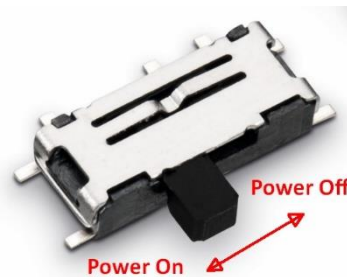

- The board comes preconfigured to boot correctly via SD-Card on arrival.
- Connect the micro USB cable to USB.

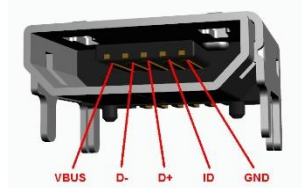
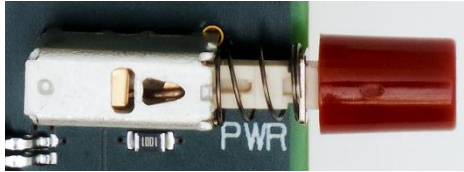

Figure 4 USB Connector

- Connect other peripherals as far as intended.
- Make sure the power switch PWR is in off position (released)

Figure 5 Power Switch Off



- Connect the 12V power line to the PWRA connector



Figure 6 Power Jack

- Switch on the power by switch PWR

Figure 7 Power Switch ON

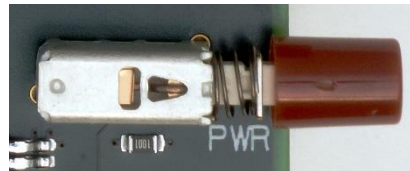

---

**After Power-On, the green LED on the carrier should light up.  
IF NOT, DISCONNECT THE UNIT IMMEDIATELY FROM THE POWER SOURCE AND CHECK FOR FAULTS!**

---

## 3.3 Operation

### 3.3.1 U-Boot Startup

When power is supplied the system will start.

On startup, U-Boot will come up similar to the following:



---

The exact output may vary, depending on U-Boot and MPX-S32V module versions in use.

---

```
U-Boot 2016.01 (Aug 04 2017 - 09:06:53 +0200)
```

```
CPU:   NXP S32V234 at 1000 MHz
Reset cause: unknown reset
Board: mpxs32v234-R2
I2C:   ready
DRAM:  2 GiB
All (4) cores are up.
MMC:   FSL_SDHC: 0
In:    serial
Out:   serial
Err:   serial
Net:   FEC
=>
```

## 4 System Description

This section describes all parts of the SBC-S32V system.

### 4.1 Block Diagram CRX-S32V Carrier

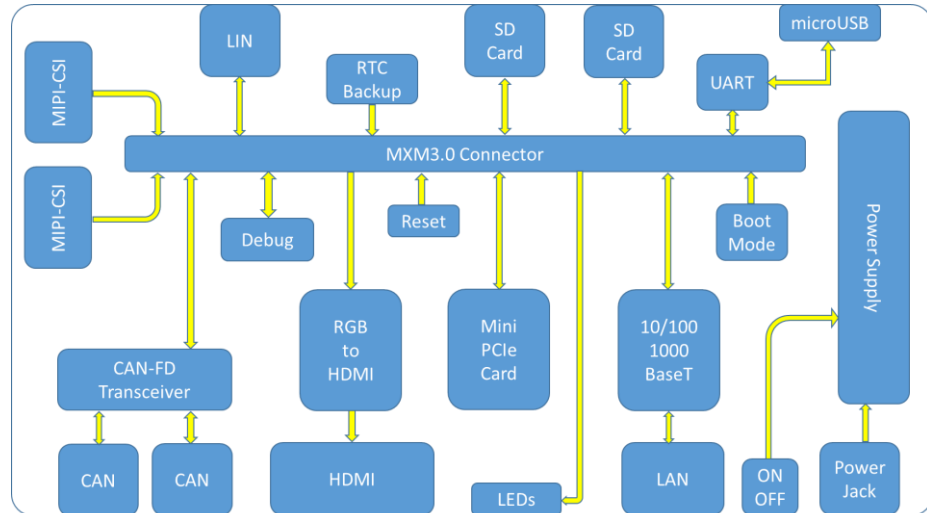

### 4.2 Block Diagram MPX-S32V Module

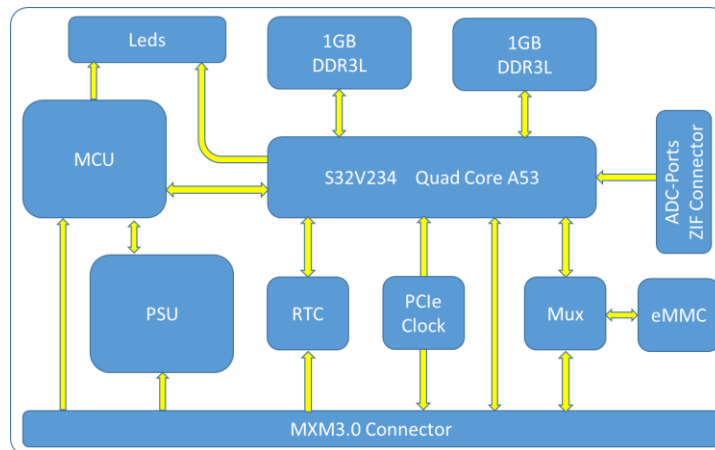

## 4.3 Feature Overview

| Feature                  | Type                        | Description  |
|--------------------------|-----------------------------|--|
| <b>CPU</b>               | NXP S32V234                 | CoreClock 1GHz<br>Quad-Cortex®-A53<br>Single-Cortex®-M4                    |
| <b>SDRAM</b>             | Dual 32-bit DDR3L interface | 2 x up to 1GByte<br>up to 1066MT/s   |
| <b>Mass Storage</b>      | 8-bit eMMC                  | 16 GByte   |
| <b>PCI Express</b>       | miniPCIe Slot               | Rev.2.0<br>5Gbps<br>Lane x1<br>RC/EP<br>100MHz Clock Source<br>I2C support |
| <b>Removable Media</b>   | eSDHC-I / (eSDHC-II)        | micro SD card holders<br>4bit support                                      |
| <b>Ethernet</b>          | RGMII                       | KSZ9031RN Phy<br>10/100/1000 BaseT<br>Link/ Activity Leds                  |
| <b>Grahics Output</b>    | TFP410                      | HDMI Type A<br>DDC support   |
| <b>Video Input</b>       | MIPI-CSI-A                  | 5V/12V supply<br>4 Lanes + Clock<br>27MHz Ref Clock<br>Mounting Holes      |
|                          | MIPI-CSI-B                  | 5V/12V supply<br>4 Lanes + Clock<br>27MHz Ref Clock<br>Mounting Holes      |
| <b>Serial Interfaces</b> | UART0                       | USB to serial Converter<br>USB-powered<br>micro USB Type B                 |
|                          | UART1                       | LIN 2.1 interface<br>MC33662BLEF   |
| <b>CAN Interface</b>     | CAN-FD-1                    | TJA1051<br>120R Termination<br>CML Filter<br>ESD Protection                |
|                          | CAN-FD-2                    | TJA1051<br>120R Termination<br>CML Filter<br>ESD Protection                |
| <b>RTC</b>               | Time/Date                   | PCF85263A<br>2032 coin cell backup   |
| <b>Board Control</b>     | S9KEAZN64A                  | Voltage supervision<br>Reset logic<br>Boot configuration<br>Status led     |
| <b>Board Switches</b>    | Modul Switches              | RCON/Serial Select<br>GPU Power Off  |

| Feature                 | Type                   | Description   |
|-------------------------|------------------------|---|
|                         | Carrier Switches       | Power On/Off<br>Reset Button<br>Boot Mode 1<br>Boot Mode 2<br>CAN1 Termination On/Off<br>CAN2 Termination On/Off  |
| <b>Board Connectors</b> | Modul Connectors       | ADC Channel 0-7<br>MCU Programming Port   |
|                         | Carrier Connectors     | 12V Power Input<br>5V/12V Aux Power Out<br>5V/12V Fan Power Out<br>314 pin MXM Connector<br>microSD-A<br>microSD-B (not mounted)<br>miniPCIe<br>microUSB<br>RJ45 LAN<br>HDMI Out<br>MIPI-A<br>MIPI-B<br>CAN-A<br>CAN-B<br>LIN Interface<br>JTAG |
| <b>Indicators</b>       | Module Leds            | MCU Status<br>Reset Status<br>User GPIO1<br>User GPIO2  |
|                         | Carrier Leds           | 12V Power Indicator<br>User Led 1<br>User Led 2   |
| <b>Debug</b>            | JTAG                   | 10 pin Header   |
| <b>Power Management</b> | System On/Off          | Pushbutton Switch   |
|                         | Input Voltage          | 12V DC  |
|                         | Input Current          | typical. <1A, no loads  |
|                         | Supply Polarity        | Reverse voltage protected   |
|                         | Oversvoltage           | TVS protected   |
|                         | Input Fuse             | 3A PPTC type  |
|                         | Module POL regulators  | 1.0V, max 10A<br>1.35V, max.6A<br>1.8V, max 3A<br>3.3V, max 3A  |
|                         | Carrier POL regulators | 1.5V,max.3A<br>3.3V, max 3A<br>5.0V, max 3A   |
|                         | RTC Backup             | 2032 coin cell  |
| <b>Shielding</b>        | Connector Shield       | connected to Ground   |
|                         | ESD Discharge          | connected to Ground   |
| <b>Mechanics</b>        | Dimension              | 93x126mm  |

| Feature | Type              | Description  |
|---------|-------------------|--|
|         | Module Mounting   | 4 Mounting Holes, 2.5mm Ø<br>all electrically floating                                     |
|         | Carrier Mounting  | 4 Mounting Spacers, M2.5<br>2 Holes electrically floating<br>2 Holes electrically grounded |
|         | miniPCle Mounting | 2 Mounting Spacers, M2.5<br>all electrically grounded                                      |
|         | MIPI-A Mounting   | 2 Mounting Holes, 3.2mm Ø<br>all electrically grounded                                     |
|         | MIPI-B Mounting   | 2 Mounting Holes, 3.2mm Ø<br>all electrically grounded                                     |



## 4.4 Mechanical Dimensions

### 4.4.1 MPX-S32V Module

The following drawing shows the mechanical outline of the MPX-S32V module that is plugged in the CRX-S32V carrier board.



This drawing is not to scale.



For 3D data files please contact MicroSys.

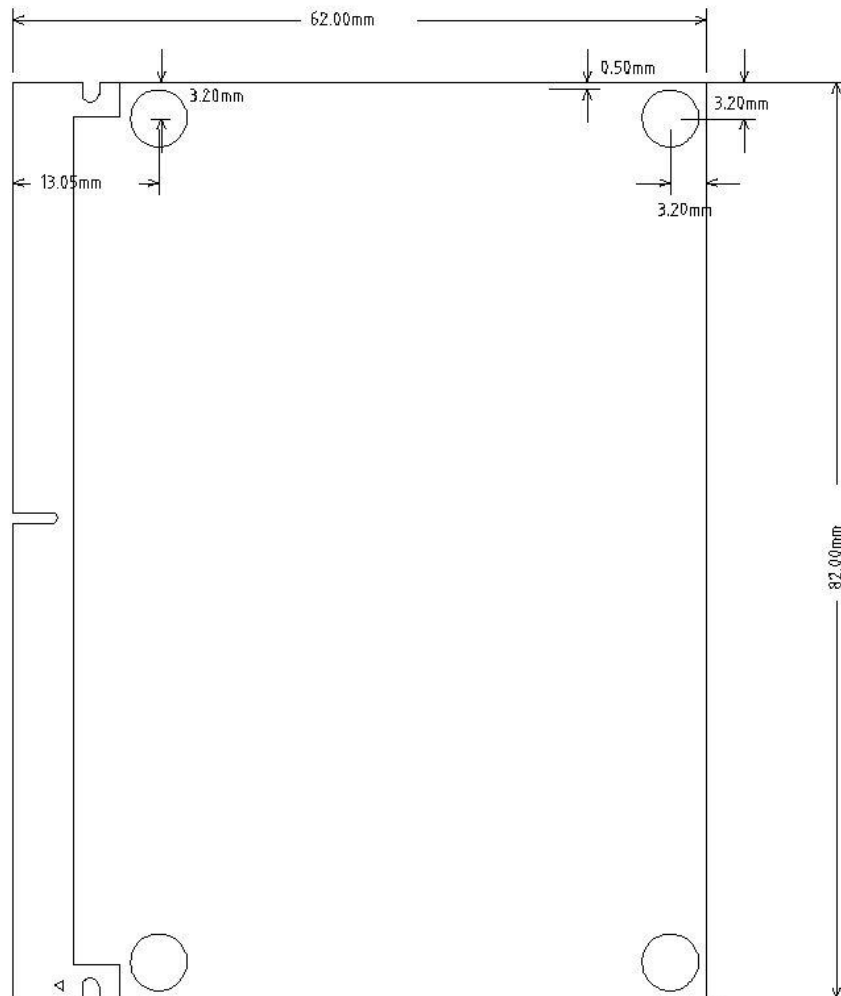

Figure 8 Mechanical Dimensions

### 4.4.2 CRX-S32V Carrier

The following drawing shows the mechanical outline of the SBC-S32V assembly.



This drawing is not to scale.



For 3D data files please contact MicroSys.

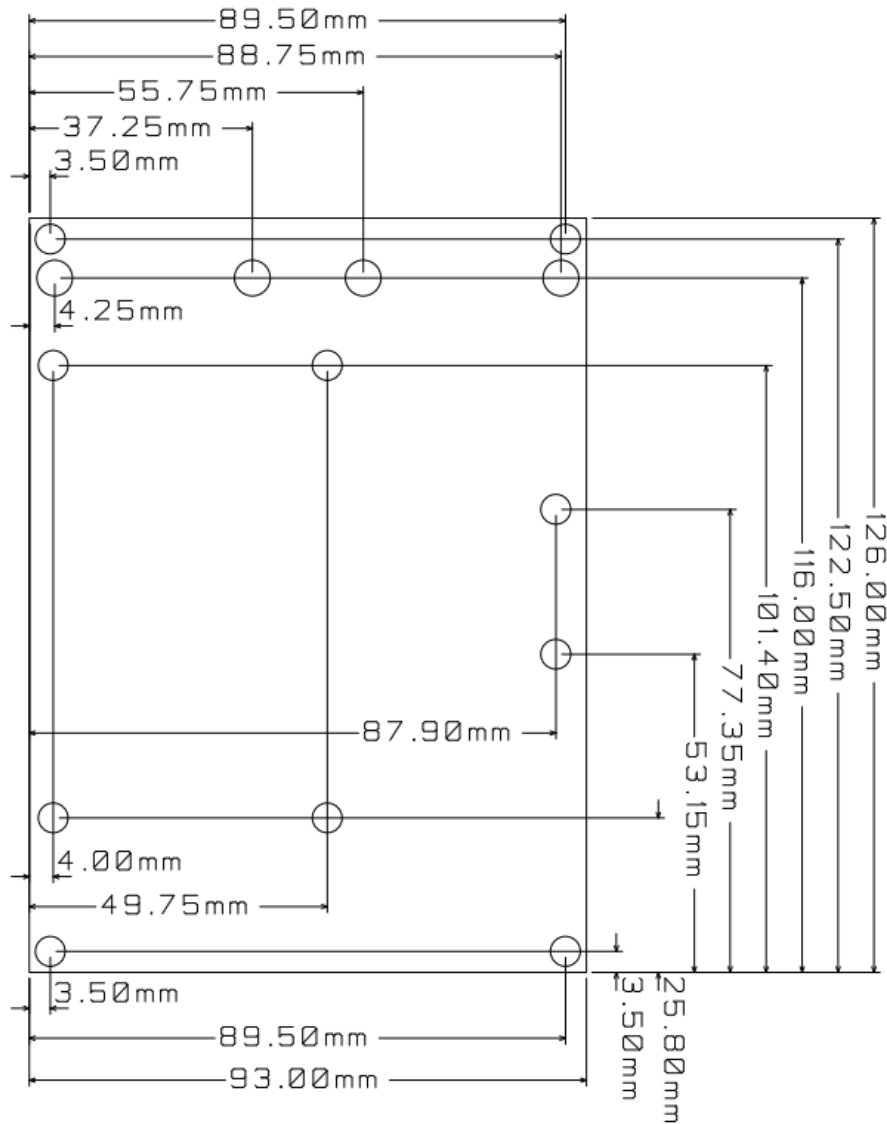

## 4.5 Carrier Board Layout – Module Side

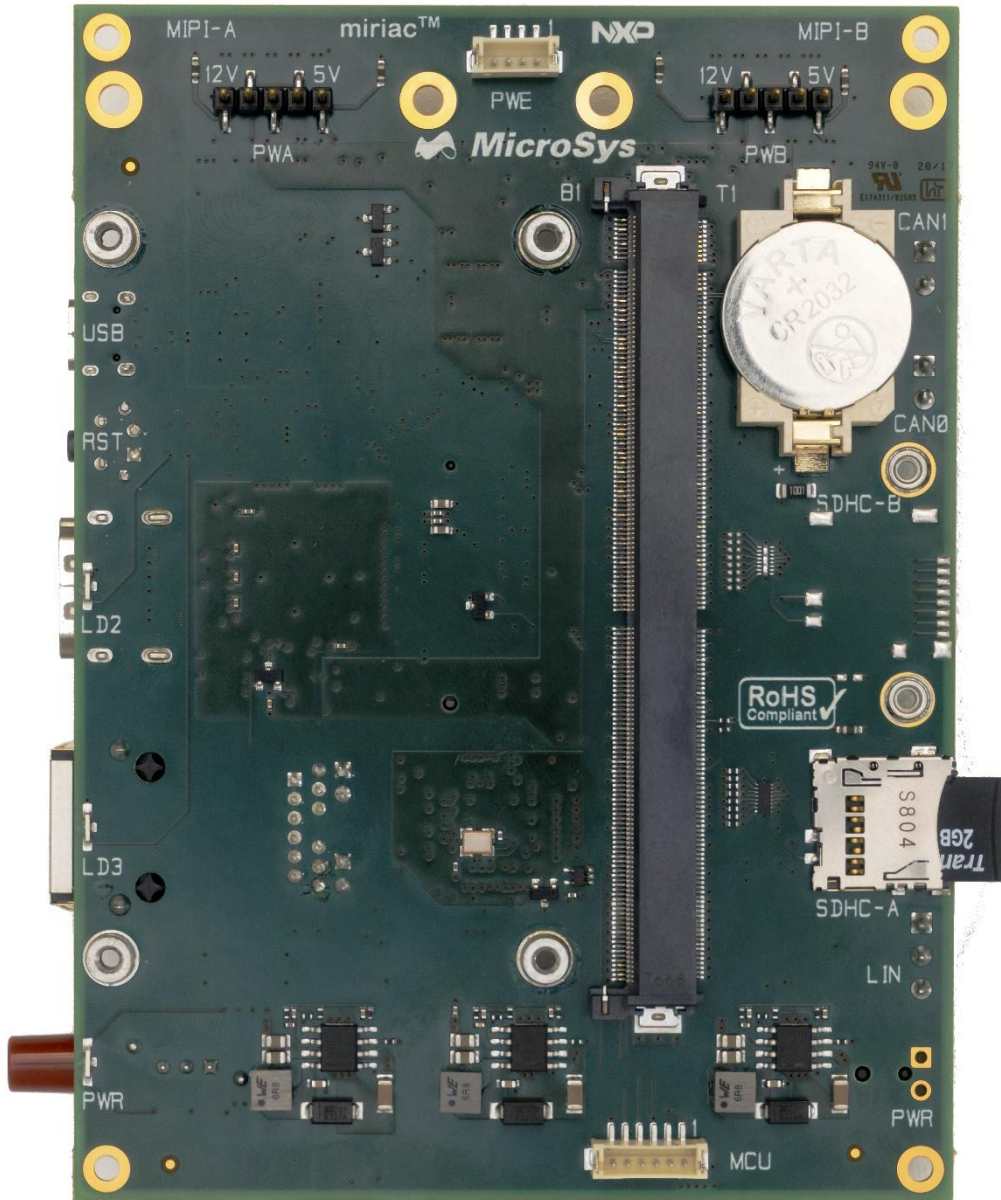

Figure 9: Module Side connectors (carrier CRX-S32V)

## 4.6 Carrier Board Layout – Non-Module Side

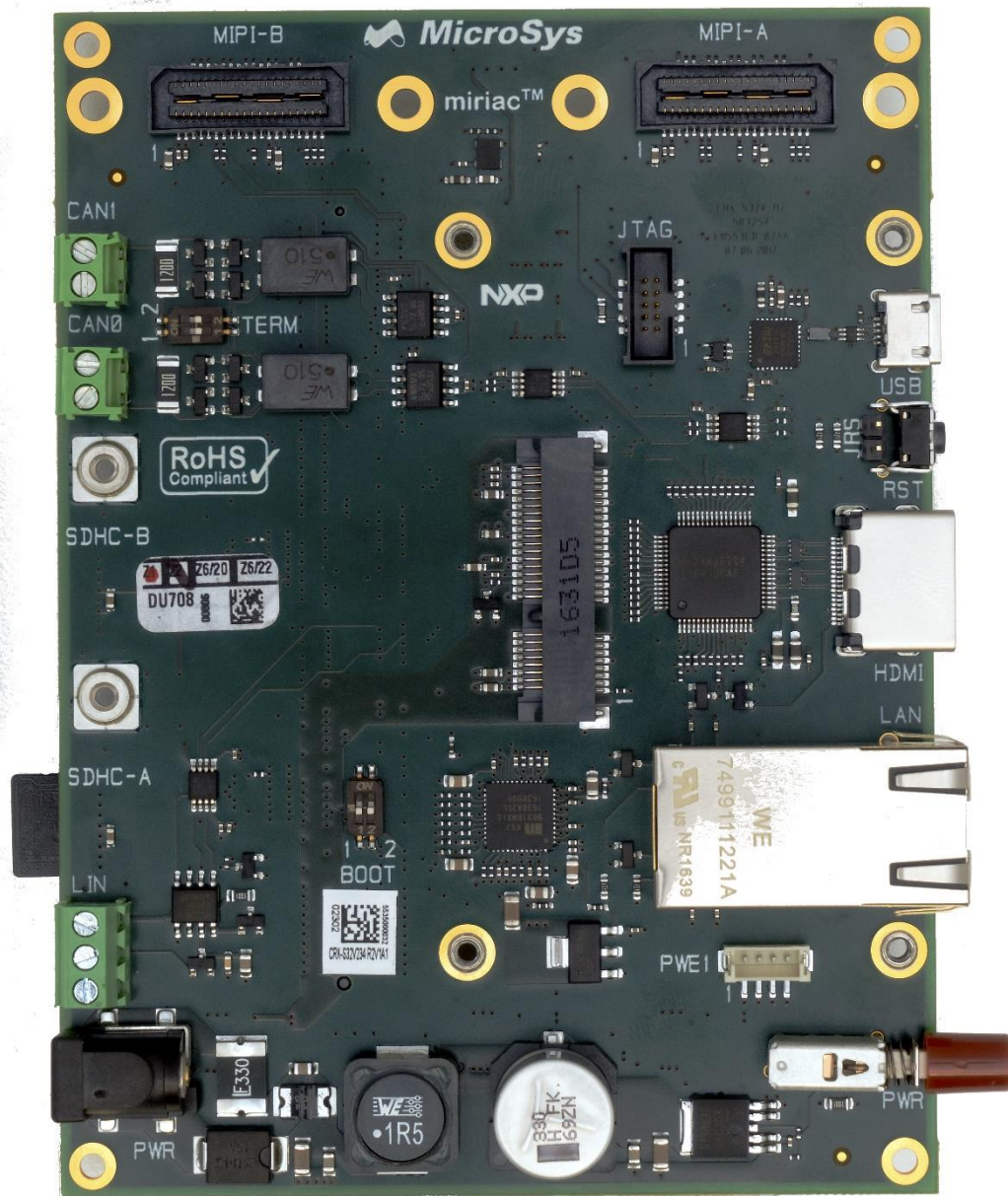
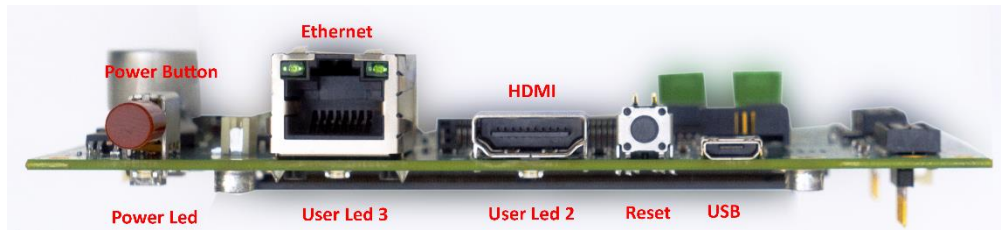
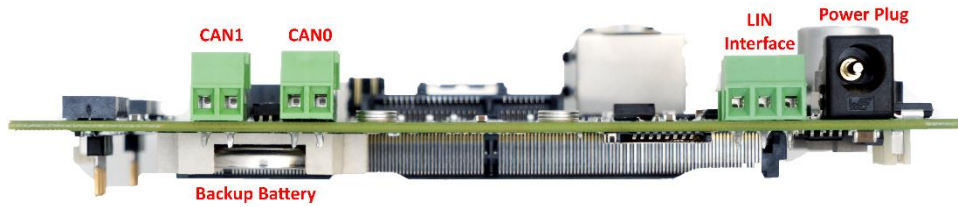

Figure 10 Non-Module Side connectors (carrier CRX-S32V)

### 4.7 Carrier Power Button Side View



### 4.8 Carrier Power Plug Side View



### 4.9 Carrier Bottom Side View



### 4.10 Carrier Top Side View

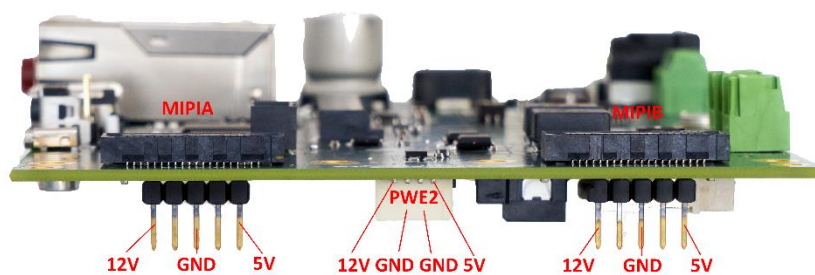

### 4.11 Module Top Side

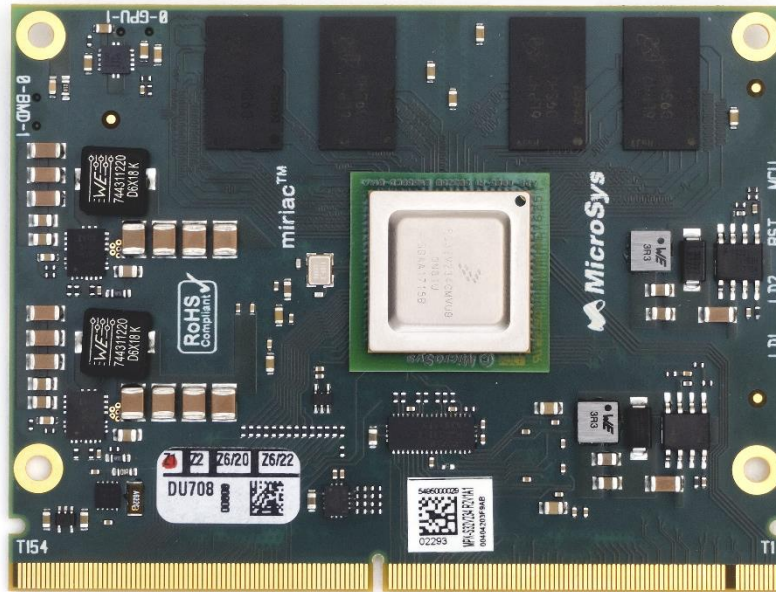

### 4.12 Module Bottom Side



## 4.14 System Environment

### 4.14.1 Temperature Ratings

The SBC-S32V contains parts with the following ambient, junction or case temperature ratings. Due to these limits, the system function is only guaranteed, if none of them are exceeded at any time. The heatsink of the MPX-S32V requires an adequate air flow, which can be accomplished by free or forced air convection.

If an active cooling is desired, a fan can be connected to one of the power connectors PWE1 or PWE2, which provide +5.0V as well as +12V.

| Part                    | Tmin  | Tmax  |
|-------------------------|-------|-------|
| BAT-CR2032MFR-1BL       | -30°C | 70°C  |
| BAT-HOLDER-79527141     | -55°C | 85°C  |
| C-0402-NP0-Series       | -55°C | 125°C |
| C-0402-X5R-Series       | -55°C | 85°C  |
| C-0402-X7R-Series       | -55°C | 125°C |
| C-0603-226-X5R-Z        | -55°C | 85°C  |
| C-0603-X7R-Series       | -55°C | 125°C |
| C-0805-X7R-Series       | -55°C | 125°C |
| C-1206-X7R-Series       | -55°C | 125°C |
| C-EEEFK1H331AQ          | -55°C | 105°C |
| CML-744-227             | -40°C | 125°C |
| CML-744-233-670         | -40°C | 85°C  |
| D-B320A-13-F            | -55°C | 150°C |
| D-BAS70                 | -65°C | 150°C |
| D-BAT54S                | -55°C | 125°C |
| D-SD2114S040S5R0        | -55°C | 125°C |
| FB-742-792-XXX          | -55°C | 125°C |
| HEADER-2.54-180-M-1X2   | -40°C | 125°C |
| HEADER-2.54-180-SM-1X5  | -40°C | 163°C |
| IC-BTS462T              | -40°C | 150°C |
| IC-DSC1001CI2-027.0000  | -40°C | 85°C  |
| IC-DSC557-0344FI1       | -40°C | 85°C  |
| IC-FT232RQ              | -40°C | 85°C  |
| IC-IR347xMTRPBF         | -40°C | 125°C |
| IC-KSZ9031RNXIA         | -40°C | 85°C  |
| IC-MAX4886ETO           | -40°C | 85°C  |
| IC-MC33662BLEF          | -40°C | 125°C |
| IC-MT41K256M16HA-107-IT | -40°C | 95°C  |
| IC-MTFC16GAKAENA-4M-IT  | -40°C | 85°C  |
| IC-NCV8715SQ50T2G       | -40°C | 125°C |

| Part                     | Tmin  | Tmax  |
|--------------------------|-------|-------|
| IC-PCA9517ADP            | -40°C | 85°C  |
| IC-PCF85263ATL           | -40°C | 85°C  |
| IC-PS32V234CMN0VUB       | -40°C | 125°C |
| IC-REF3030AIDBZ          | -40°C | 125°C |
| IC-S9KEAZN64AMLH         | -40°C | 85°C  |
| IC-SN74LVC1G04DCK        | -40°C | 85°C  |
| IC-SN74LVC1G125DCK       | -40°C | 125°C |
| IC-SN74LVC244ARGYR       | -40°C | 125°C |
| IC-TFP410PAP             | 0°C   | 70°C  |
| IC-TJA1051T              | -40°C | 105°C |
| IC-TPS22920LYZP          | -40°C | 85°C  |
| IC-TPS51200DRC           | -40°C | 85°C  |
| IC-TPS5433xDDAR          | -40°C | 150°C |
| IC-TPS70933DBV           | -40°C | 125°C |
| L-744-311-220            | -55°C | 125°C |
| L-744-383-56033          | -40°C | 85°C  |
| L-744-383-57068          | -40°C | 85°C  |
| L-744-771-001            | -55°C | 125°C |
| LD-155124xx73200         | -40°C | 85°C  |
| PCB-ADP-8065-01          | -40°C | 85°C  |
| PCB-CRX-S32V-01          | -40°C | 85°C  |
| PCB-MPX-S32V-02          | -40°C | 85°C  |
| PTC-2920L330/24          | -40°C | 85°C  |
| R-0402-Serie             | -55°C | 155°C |
| R-0603-Serie             | -55°C | 155°C |
| R-0805-Serie             | -55°C | 155°C |
| R-1206-Serie             | -55°C | 155°C |
| R-2010-Serie             | -55°C | 155°C |
| RC-IP4252CZ16-8          | -40°C | 85°C  |
| ST-JAE-MM70-314-310-B1-1 | -40°C | 85°C  |
| ST-JST-SM06B-XSRS-ETB    | -25°C | 85°C  |
| ST-SAM-QSE-020-01-F-D    | -55°C | 125°C |
| ST-SAM-SHF-105-01-L-D-SM | -55°C | 125°C |
| ST-TYCO-2041119-1-PCIe   | -55°C | 85°C  |
| ST-WE-629-105-150-521    | -40°C | 85°C  |
| ST-WE-679-30x-124-022    | -25°C | 85°C  |
| ST-WE-685-119-134-923    | -25°C | 85°C  |
| ST-WE-687-118-140-22     | -25°C | 85°C  |
| ST-WE-691-214-110-00x    | -40°C | 105°C |
| ST-WE-694-106-106-102    | -40°C | 85°C  |



| Part                         | Tmin  | Tmax  |
|------------------------------|-------|-------|
| ST-WE-749-911-1221A          | 0°C   | 70°C  |
| ST-YE-PJS-008-2130-0         | -25°C | 85°C  |
| SW-CK-G003R                  | -10°C | 60°C  |
| SW-CK-PN12SHSA03QE           | -10°C | 60°C  |
| SW-WE-416-131-160-802        | -40°C | 85°C  |
| SW-WE-431-256-038-716        | -40°C | 85°C  |
| SW-WE-450-404-015-514        | -40°C | 85°C  |
| T-BSS138LT1                  | -55°C | 150°C |
| T-FDT434P                    | -55°C | 150°C |
| T-PDTA114YT                  | -55°C | 150°C |
| T-PDTC123JT                  | -65°C | 150°C |
| TVS-1.5SMC15AT3              | -65°C | 150°C |
| TVS-ESD7504MUTAG             | -55°C | 125°C |
| TVS-PSOT36LC                 | -55°C | 150°C |
| TVS-USBLC6-2P6               | -40°C | 125°C |
| XT-FT13A-xx.00000/8-20-20/48 | -40°C | 85°C  |
| XT-FT26A-32.7680/12.5-20/48  | -40°C | 85°C  |
| Y-WE-977-403-0151-M25-3MM00  | -55°C | 125°C |

#### 4.14.2 Power Dissipation

| Component      | max. Temperature      | Power Dissipation |
|----------------|-----------------------|-------------------|
| CPU            | T <sub>j</sub> 125° C | 7W                |
| DDR            | T <sub>c</sub> 95° C  | 1.5W              |
| Core Regulator | T <sub>j</sub> 125° C | 1.2W              |
| DDR Regulator  | T <sub>j</sub> 125° C | 0.3W              |
| eMMC           | T <sub>a</sub> 85° C  | 0.5W              |
| LAN            | T <sub>j</sub> 125° C | 0.9W              |
| HDMI           | T <sub>a</sub> 70° C  | 0.9W              |

(j=junction, c=case, a=ambient)

## 4.15 Power Supply

### 4.15.1 Input Supply Rating

The SBC-S32V system is run from a single power supply with the following ratings:

|   |                     |
|---|---------------------|
| <b>Input Voltage Operating Range:</b>   | <b>12V DC +/-5%</b> |
| <b>Typical Current Consumption<br/>(@12V / room temperature / U-boot prompt):</b> | <b>0,40A</b>        |

The input of the SBC-S32V system is protected against wrong polarity and over current



**DO NOT exceed the rated maximum values for the power supply! This may result in severe permanent damage to the unit, as well as possible serious injury.**

### 4.15.2 Input Power Connector

Power is fed to the unit via the 2-pin DC power jack PWRA

|               |                             |
|---------------|-----------------------------|
| Manufacturer: | Würth Elektronik            |
| Type:         | 694-106-106-102             |
| Mates with:   | dc power plug 5.5mm x 2.5mm |

Figure 4-6 Power Jack



### 4.15.3 Input Power Switch

The unit can be switch on and off by a push button switch. The switch controls all on system supply rails via a high side power switch. The silicon switch has a nominal load current of 3.5A, an on-state resistance of 100mR and it is fully protected against current and thermal overload.

The push button switch has two alternate positions, i.e. pressed and released. The position of the switch sets the power state of the SBC-S32V system. It will not be reset, in case the power cord is disconnected. The switch can be optionally equipped with various switch caps in form and color

|               |                    |
|---------------|--------------------|
| Manufacturer: | C&K-Components     |
| Type:         | PN12SHSA03QE       |
| Mates with:   | G001/2/3/4-A/G/I/R |

Figure 12: G003-Series



Figure 11:PN12SHSA03QE



### 4.15.4 Fuses

There is a PPTC fuse on the SBC-S32V.

The part is a self-resettable fuse with a nominal current rating of 3.3A at 20°C ambient temperature. The current is derated due to the ambient temperature according to the following table:

|       |       |      |      |      |      |      |      |      |
|-------|-------|------|------|------|------|------|------|------|
| -40°C | -20°C | 0°C  | 20°C | 40°C | 50°C | 60°C | 70°C | 85°C |
| 4,7A  | 4,2A  | 3,8A | 3,3A | 2,9A | 2,6A | 2,3A | 1,9A | 1,6A |

Figure 4-7 Fuse Derating

### 4.15.5 Power Supply Structure

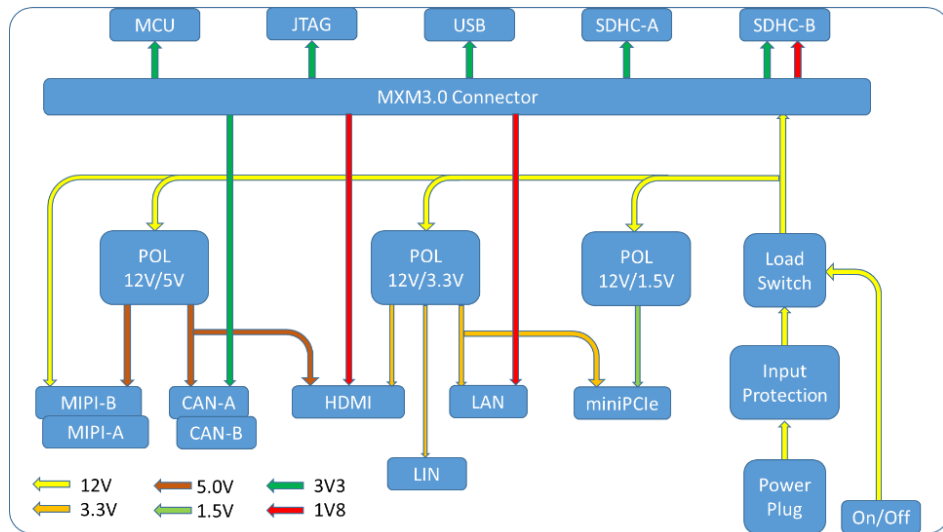

Figure 13 Power supply structure

### 4.15.6 Power Distribution

There are two power connectors available onboard the SBC-S32V. These 4 pin shrouded header connectors can be used to connect an external fan or for additional supply voltages required for miniPCIe modules. The current rating is limited to 1A per pin. The voltages are switched on and off by the main power switch. The +12V voltage is sourced by the input voltage, which is derated by maximal 550mV, caused by the input polarity protection diode. An external load must not feed in any reverse current or voltage during any power state, f.e. an external inductive load must be equipped with a freewheeling circuit.

|               |              |
|---------------|--------------|
| Manufacturer: | Würth        |
| Type:         | 679304124022 |
| mates with:   | 648004113322 |

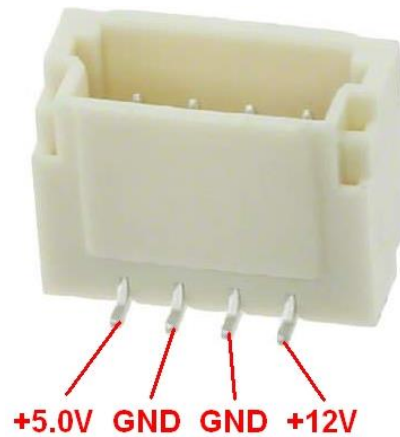

Figure 14: Connector PWE1 & PWE2

### 4.15.7 MIPI Power

The two MIPI ports of the SBC-S32V system can be either work with 5.0V only or mixed with +5.0V and +12V. This option is handled by two 5 pin 2.54mm headers.

|               |                    |
|---------------|--------------------|
| Manufacturer: | Fischerelektronik  |
| Type:         | SL10SMD0525G       |
| mates with:   | 2.54mm Jumper Link |

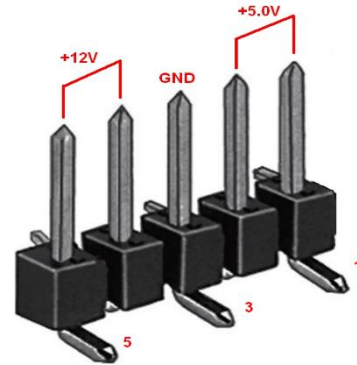

Figure 15: Header PWA & PWB

| PWA | Signal | Description                  |
|-----|--------|------------------------------|
| 1   | +5.0V  | Power Rail                   |
| 2   | VCCA   | Supply for MIPIA Pin 25 & 27 |
| 3   | GND    | Ground                       |
| 4   | VCCA   | Supply for MIPIA Pin 25 & 27 |
| 5   | +12V   | Power Rail                   |

| PWB | Signal | Description                  |
|-----|--------|------------------------------|
| 1   | +5.0V  | Power Rail                   |
| 2   | VCCB   | Supply for MIPIB Pin 25 & 27 |
| 3   | GND    | Ground                       |
| 4   | VCCB   | Supply for MIPIB Pin 25 & 27 |
| 5   | +12V   | Power Rail                   |

In case the pins 25 and 27 should not be powered, no link at all should be installed. If these pins should be grounded, a link between pin 2 and 3 or 3 and 4 must be set.



**Anyway, only a single link per header must be set at a time. More than one link installed may cause permanent damage to the board!**

### 4.15.8 Power Up

During a power up sequence, the MCU first checks the input voltage to be within their necessary limits. After that, the POL (Point Of Load) regulators on the module will be activated as well as the tracking regulators for 5V, 3.3V and 1.5V on the carrier board. If all module voltages are o.k. the reset sequence will be started. If there is no external reset request, f.e. via RSTIN# from the reset key, the RESET# will be released after 100ms. A low level on the RSTIN# line extends this time. During normal operation, a falling edge at RSTIN# initiates a reset sequence for the whole system, which is at least 100ms long. As long the reset key is pressed, the system will be held in the reset state. If the key is released, the CPU will fetch its power up configuration and starts up with its BIST and/or boot sequence. The RSTOUT# signal will directly follow the state of the RESET# signal. As long the RSTOUT# is active all connected devices must be held in a reset state in order not to block the power up configuration settings.

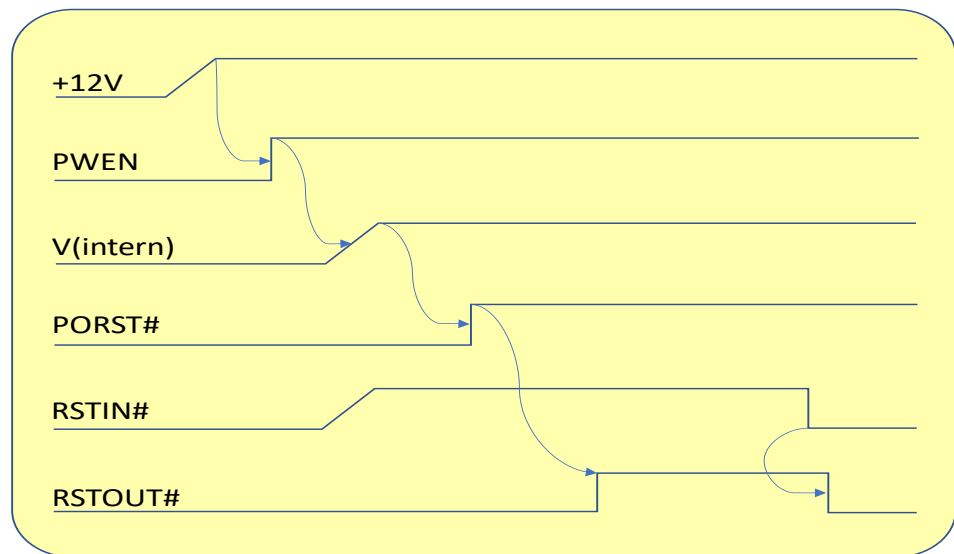

In case the MCU detects any overvoltage, it will turn off all internal point of load regulators. The external supply voltage is reverse polarity protected and limited by a 15V transient voltage suppressor diode to protect the system. The input poly fuse is rated for a maximum voltage of 24V, i.e. any voltage above that limit will destroy the input protection of the system.

## 4.16 Reset Structure

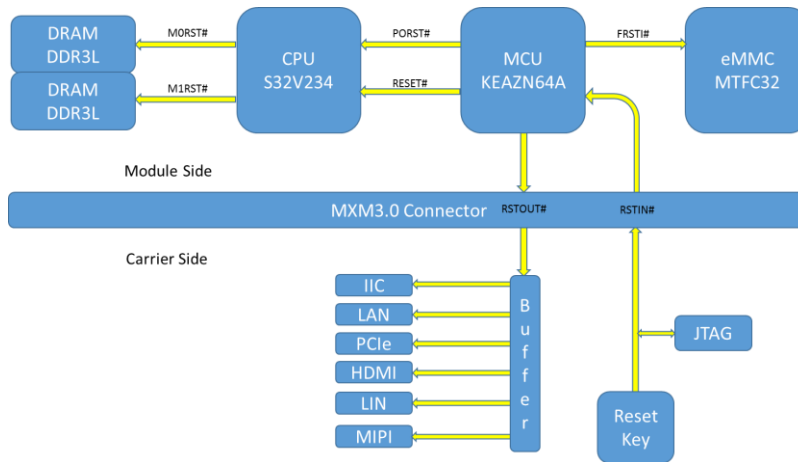

Figure 4-3 Reset Structure

| Signal Name                      | Function                   | Type       |
|----------------------------------|----------------------------|------------|
| RSTIN#                           | System Global Reset Input  | 4K7 Pullup |
| RSTOUT#                          | System Global Reset Output | Totem Pole |
| PORST#                           | Power-On Reset for CPU     | Totem Pole |
| RESET#                           | Reset for CPU              | Open Drain |
| FRSTI#                           | Reset for eMMC device      | Totem Pole |
| M0RST#                           | Reset for Memory Bank 0    | Totem Pole |
| M1RST#                           | Reset for Memory Bank 1    | Totem Pole |
| (# denotes an active low signal) |                            |            |

Table 4-3 Reset signal overview



# 5 System Core, Boot Configuration

## 5.1 Processor NXP S32V234

The S32V234 is a vision processing MPU with four ARM® Cortex®-A53 cores and a single Cortex-M4 core. The four CPU cores run at a maximum clock speed of 1000MHz.

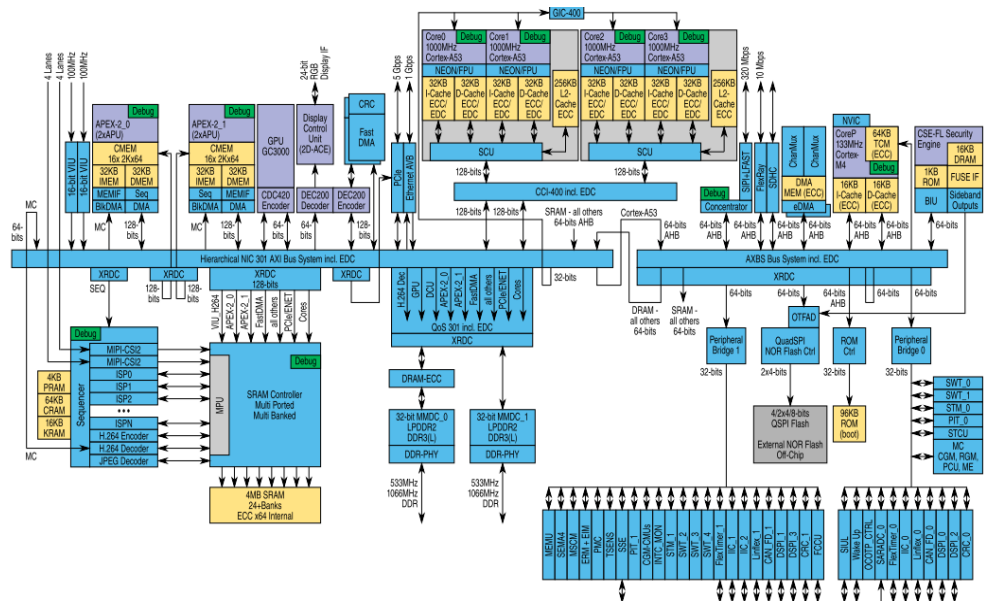

Figure 4-7 Processor Block diagram

## 5.2 Boot Mode Configuration

The SBC-S32V board offers several different boot modes to choose from. The settings can be done via the sliding switch BMD on the module and the dipswitch BOOT on the carrier according to following table.

The switch BMD sets the BMODE[0] and BMODE[1] signals of the CPU to low, while the two configuration resistors BMD0 and BMD1 are used to set a fixed low value on these lines.

The parts BMD, BMD0 and BMD1 are located on the MPX-S32V module.

| Boot Mode                      | BMD-Switch  | BMD0 <sup>1)</sup> | BMD1 <sup>1)</sup> |
|--------------------------------|-------------|--------------------|--------------------|
| Serial Download, virgin device | No function | installed          | installed          |
| Serial Download, virgin device | Position 0  | removed            | installed          |
| Serial Download, prog. device  | Position 1  | removed            | installed          |
| RCON Boot, if no fuses         | Position 0  | installed          | removed            |
| Serial Download, prog. device  | Position 1  | installed          | removed            |
| RCON Boot, no fuses            | Position 0  | removed            | removed            |
| Serial Download, prog. device  | Position 1  | removed            | removed            |

**green denotes the default configuration**

Note 1) BMD0 and BMD1 are soldered resistors (size 0402) and not intended to be changed by user.



Figure 16: BMD Switch

Shown positions set the according BTMOD0/1 line to low. BTMOD0 controls the CPU configuration port PC9, i.e. BOOTMOD(0), while BTMOD1 is connected to the CPU configuration port PC10, i.e. BOOTMOD(1).

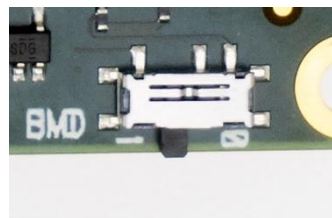

Figure 18: Position BTM1=low

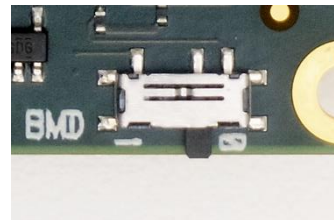

Figure 17: Position BTM0=low

### 5.3 Boot Mode Switch

The boot mode switch BOOT located on the CRX-S32V, allows the following default boot modes, in case the BMD switch is set to position RCON. If the BMD switch is set to serial download, the BOOT switch has no function.

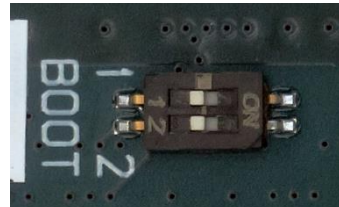





Figure 19: Boot Mode Switch

| Setting   | BOOT-SEL1 | BOOT-SEL2 | Boot Device           |
|---|-----------|-----------|-----------------------|
|    | OFF       | OFF       | Cortex A53 via SDHC-A |
|    | ON        | OFF       | Cortex A53 via eMMC   |
|   | OFF       | ON        | Cortex M4 via SDHC-A  |
|  | ON        | ON        | Cortex M4 via eMMC    |

**green denotes the default configuration**

In case, the eMMC or the SDHC-Slot should be used after a boot from the other device, the Boot Mode Switch 1 must be set to either position and the “MMC RESCAN” command must be executed within u-boot. The “MMC INFO” command will then show the new active storage device.

## 5.4 Power Up Configuration

The S32V234 is configured during power up by the state of 32 I/O signals, which are controlled by the MCU. Within the MCU, the four most popular RCON boot configurations are implemented and can be selected via the dip-switch BOOT placed on the carrier board.



These configurations are only valid, if the Boot Mode Configuration is set to RCON Boot!

| Signal    | RCON     | Port   | eSDHC Mode | eMMC Mode |
|-----------|----------|--------|------------|-----------|
| FLXR-TENB | RCON[0]  | PA[7]  | 0          | 0         |
| FLXR-TXD  | RCON[1]  | PA[8]  | 0          | 0         |
| FLXR-RXD  | RCON[2]  | PA[9]  | 0          | 0         |
| UART0-RXD | RCON[3]  | PA[11] | 0          | 0         |
| UART0-TXD | RCON[4]  | PA[12] | 0          | 1         |
| UART1-RXD | RCON[5]  | PA[13] | 0          | 0         |
| UART1-TXD | RCON[6]  | PA[14] | 0          | 1         |
| I2C0-SDA  | RCON[7]  | PA[15] | 1          | 1         |
| I2C0-SCL  | RCON[8]  | PB[0]  | 0          | 0         |
| I2C1-SDA  | RCON[9]  | PB[1]  | 0          | 0         |
| I2C1-SCL  | RCON[10] | PB[2]  | 0          | 0         |
| I2C2-SDA  | RCON[11] | PB[3]  | 0          | 1         |
| SPI0-SCK  | RCON[12] | PB[5]  | 0          | 0         |
| SPI0-SOUT | RCON[13] | PB[6]  | 0          | 0         |
| SPI0-SIN  | RCON[14] | PB[7]  | 0          | 0         |
| SPI0-CS0# | RCON[15] | PB[8]  | 0          | 1         |
| SPI1-SCK  | RCON[16] | PB[9]  | 0          | 1         |
| SPI1-SOUT | RCON[17] | PB[10] | 0          | 0         |
| SPI1-SIN  | RCON[18] | PB[11] | 0          | 0         |
| SPI1-CS0# | RCON[19] | PB[12] | 0          | 0         |
| SPI2-SCK  | RCON[20] | PB[13] | 0          | 0         |
| SPI2-SOUT | RCON[21] | PB[14] | 1          | 1         |
| SPI2-SIN  | RCON[22] | PB[15] | 0          | 0         |
| SPI2-CS0# | RCON[23] | PC[0]  | 0          | 0         |
| SPI3-SCK  | RCON[24] | PC[1]  | 0          | 0         |
| SPI3-SOUT | RCON[25] | PC[2]  | 0          | 0         |
| SPI3-SIN  | RCON[26] | PC[3]  | 0          | 0         |
| SPI3-CS0# | RCON[27] | PC[4]  | 0          | 0         |
| FXT0-CH0  | RCON[28] | PC[5]  | 0          | 0         |
| FXT0-CH1  | RCON[29] | PC[6]  | 0          | 0         |
| FXT0-CH2  | RCON[30] | PC[7]  | 0          | 0         |
| FXT0-CH3  | RCON[31] | PC[8]  | 1          | 1         |

## 5.5 MCU programming Port

The MCU, a Kinetis S9KEAZN64AMLH, controls the power on and the reset sequence. It monitors all module generates supply voltages and drives all configuration lines of the S32V234 CPU. The controller can be either programmed via a module connector or a connector on the carrier board, both named MCU. As the module connector is very tiny and has a pitch of 0.6mm, the carrier located connector with its 1.5mm pitch should be preferred.

MPX-S32V Connector MCU

|               |                |
|---------------|----------------|
| Manufacturer: | JST            |
| Type:         | SM06B-XSRS-ETB |
| mates with:   | 06XSR-36S      |

Figure 20: Module MCU Connector

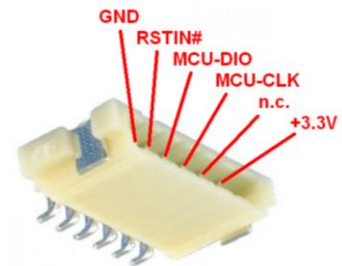

The module connector is supplied by the direct MCU supply with 3.3V, while the +3.3V supply of the carrier located connector is derived from a carrier located supply, which can be disabled by the MCU. If the MCU has configured the board with PWEN off, no supply is available on the carrier and its connectors. In this case the module connector must be used for programming or the IO voltage of the programmer is externally set to 3.3V.

CRX-S32V Connector MCU

|               |              |
|---------------|--------------|
| Manufacturer: | Würth        |
| Type:         | 679306124022 |
| mates with:   | 648006113322 |

Figure 21: Carrier MCU Connector

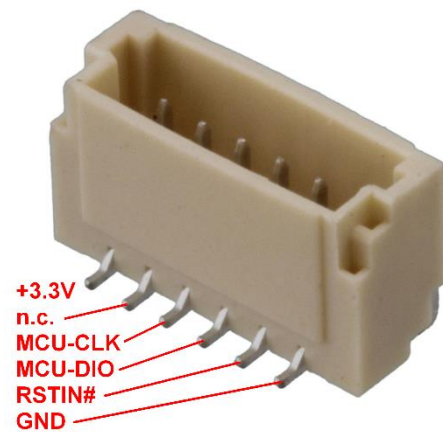
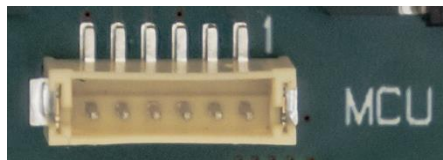

## 5.5.1 MCU Pinout

| MCU |      |     | Board    | S32V234   |          | Function                 |
|-----|------|-----|----------|-----------|----------|--------------------------|
| Pin | Port | Dir | Signal   | Signal    | RCON     |                          |
| 1   | PTD1 | Out | BCFG23   | SPI2_CS0# | RCON[23] | Configuration            |
| 2   | PTD0 | Out | BCFG29   | FXT0_CH1  | RCON[29] | Configuration            |
| 3   | PTH7 | Out | BCFG22   | SPI2_SIN  | RCON[22] | Configuration            |
| 4   | PTH6 | Out | BCFG6    | UART1_TXD | RCON[6]  | Configuration            |
| 5   | PTE7 | Out | RSTOUT#  |           |          | Modul Rest Output        |
| 6   | PTH2 |     | n.c.     |           |          | not connected            |
| 7   |      | In  | +3V3     |           |          | Supply                   |
| 8   |      | In  | VREFH    |           |          | +3.0V                    |
| 9   |      | In  | VREFL    |           |          | Reference Ground         |
| 10  |      |     | GND      |           |          | Reference Ground         |
| 11  | PTB7 | Out | FRSTI#   |           |          | eMMC Reset               |
| 12  | PTB6 | Out | PWEN     |           |          | PSU enable               |
| 13  |      |     | GND      |           |          | Reference Ground         |
| 14  | PTH1 | In  | QSPI-SEL | GPIO[158] |          | FLASH/SDHC Mux           |
| 15  | PTH0 | IO  | TRTC#    |           |          | Time Stamp RTC           |
| 16  | PTE6 | In  | IRTC#    |           |          | Interrupt RTC            |
| 17  | PTE5 | Out | PORST#   | EXT_POR#  |          | PowerOnReset             |
| 18  | PTB5 | Out | RESET#   | RESET#    |          | Reset                    |
| 19  | PTB4 | In  | FCCU-F0  | FCCU_F0   |          | Failure Check&Correction |
| 20  | PTC3 | In  | LD4      |           |          | yellow Led               |
| 21  | PTC2 | In  | +3V3     |           |          | ADC Divider 3:4          |
| 22  | PTD7 | Out | NMI      | NMI       |          | Interrupt                |
| 23  | PTD6 | Out | FCCU-F1  | FCCU_F1   |          | Failure Check&Correction |
| 24  | PTD5 | OUT | BCFGE#   |           |          | Configuration Enable     |
| 25  | PTC1 | In  | +3.3V    |           |          | ADC Divider 3:4          |
| 26  | PTC0 | In  | +1.8V    |           |          | ADC direct               |
| 27  | PTF7 | In  | +1.35V   |           |          | ADC direct               |
| 28  | PTF6 | In  | +1.0V    |           |          | ADC direct               |
| 29  | PTF5 | In  | +VIN     |           |          | ADC Divider 1:11         |
| 30  | PTF4 | Out | BCFG2    | FLXR_RXD  | RCON[2]  | Configuration            |
| 31  | PTB3 | Out | BCFG0    | FLXR_TENB | RCON[0]  | Configuration            |
| 32  | PTB2 | Out | BCFG1    | FLXR_TXD  | RCON[1]  | Configuration            |
| 33  | PTB1 | Out | BCFG3    | UART0_RXD | RCON[3]  | Configuration            |
| 34  | PTB0 | Out | BCFG4    | UART0_TXD | RCON[4]  | Configuration            |
| 35  | PTF3 | Out | BCFG7    | I2C0_SDA  | RCON[7]  | Configuration            |
| 36  | PTF2 | Out | BCFG8    | I2C0_SCL  | RCON[8]  | Configuration            |
| 37  | PTA7 | Out | BCFG9    | I2C1_SDA  | RCON[9]  | Configuration            |
| 38  | PTA6 | Out | BCFG10   | I2C1_SCL  | RCON[10] | Configuration            |
| 39  | PTE4 | Out | BCFG14   | SPIO_SIN  | RCON[14] | Configuration            |
| 40  |      |     | GND      |           |          | Reference Ground         |

| MCU |      |     | Board     | S32V234   |          | Function              |
|-----|------|-----|-----------|-----------|----------|-----------------------|
| 41  |      | In  | +3V3      |           |          | Supply                |
| 42  | PTF1 | Out | BCFG15    | SPI0_CS0# | RCON[15] | Configuration         |
| 43  | PTF0 | Out | BCFG12    | SPI0_CLK  | RCON[12] | Configuration         |
| 44  | PTD4 | Out | BCFG13    | SPI0_SOUT | RCON[13] | Configuration         |
| 45  | PTD3 | Out | BCFG24    | SPI3_CLK  | RCON[24] | Configuration         |
| 46  | PTD2 | Out | BCFG5     | UART1_RXD | RCON[5]  | Configuration         |
| 47  | PTA3 | Out | BCFG25    | SPI3_SOUT | RCON[25] | Configuration         |
| 48  | PTA2 | Out | BCFG18    | SPI1_SIN  | RCON[18] | Configuration         |
| 49  | PTA1 | Out | BCFG17    | SPI1_SOUT | RCON[17] | Configuration         |
| 50  | PTA0 | Out | BCFG31    | FXT0_CH3  | RCON[31] | Configuration         |
| 51  | PTC7 | Out | BCFG26    | SPI3_SIN  | RCON[26] | Configuration         |
| 52  | PTC6 | Out | BCFG30    | FXT0_CH2  | RCON[30] | Configuration         |
| 53  | PTE3 | Out | BCFG11    | I2C2_SDA  | RCON[11] | Configuration         |
| 54  | PTE2 | Out | BCFG16    | SPI1_CLK  | RCON[16] | Configuration         |
| 55  | PTG3 | Out | BCFG19    | SPI1_CS0# | RCON[19] | Configuration         |
| 56  | PTG2 | Out | BCFG21    | SPI2_SOUT | RCON[21] | Configuration         |
| 57  | PTG1 | Out | BCFG28    | FXT0_CH0  | RCON[28] | Configuration         |
| 58  | PTG0 | Out | BCFG27    | SPI3_CS0# | RCON[27] | Configuration         |
| 59  | PTE1 | Out | BCFG20    | SPI2_CLK  | RCON[20] | Configuration         |
| 60  | PTE0 | In  | BOOT-SEL1 |           |          | Boot Mode             |
| 61  | PTC5 | In  | BOOT-SEL2 |           |          | Boot Mode             |
| 62  | PTC4 | In  | MCU-CLK   |           |          | Programming Interface |
| 63  | PTA5 | In  | RSTIN#    |           |          | Programming Interface |
| 64  | PTA4 | IO  | MCU-DIO   |           |          | Programming Interface |



## 6 MPX-Module

The MPX-S32V miriac module fits in the MXM connector of the CRX-S32V carrier board. It must be mounted with a heatsink and is fixed with 4 Torx screws M2.5x16.

The SBC-S32V is designed to stand in an upright position with the two MIPI camera connectors on top and the heatsink as vertical support.

The recess at the bottom of the heatsink allows for an access to the MCU programming port.

In case, an active cooling is desired, the top middle connector PWE2 provides +5.0V and +12V.

All other connections and controls are located on the left and right vertical side of the system.

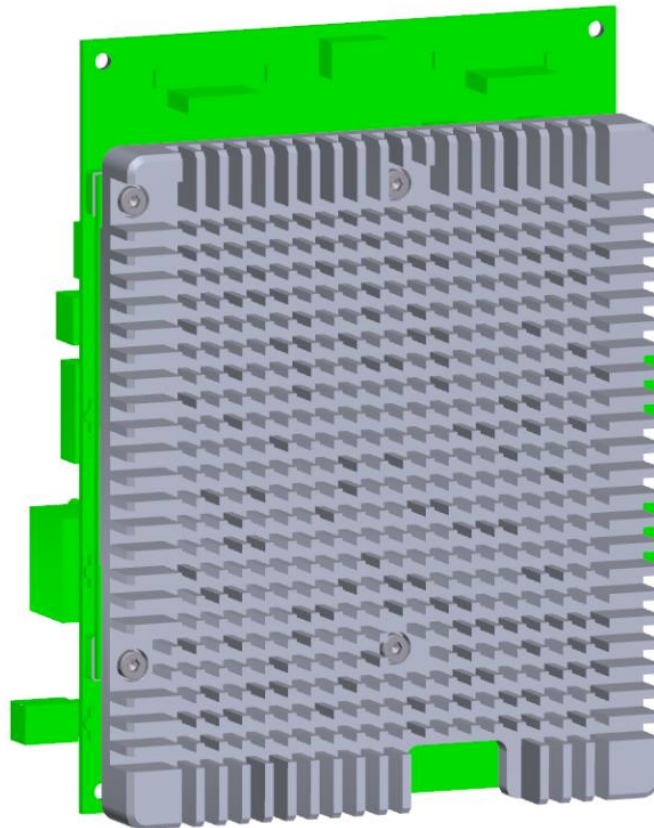

## 6.1 Mounting/Unmounting

The mounting or unmounting of the module should only be made in a static free area with full ESD precautions, i.e. as a minimum, a grounded dissipative work surface of sufficient size and a grounded skin contact wrist strap are necessary. Make sure, that all parts, the carrier, the module and the heatsink are placed on the same static free area to avoid any discharges between them during assembly.

To mount the MPX-S32V module, make sure that the carrier is disconnected from any power or other IO interfaces. Both connector surfaces of the module must be clean as well as the carrier connector should be checked for bent or dirty contacts. Check the module and the carrier for foreign or loose parts, which do not belong to the boards. The screws should have clean threads and be tightened with a maximum torque of 30Ncm.

Insert or remove the MPX-S32V module always by an angle of about 25° like shown in the following figure.

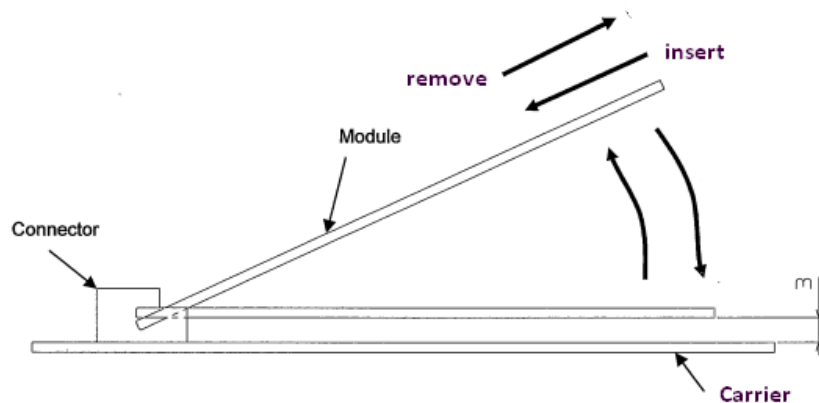

The thermal conduction between cooler and CPU is performed via a 1mm thick thermal pad. Make sure, that this thermal pad is placed over the CPU package before mounting the heatsink.

After the module has been pressed down, place the heatsink exactly over the mounting holes without scratching or touching any other parts on the PCB.

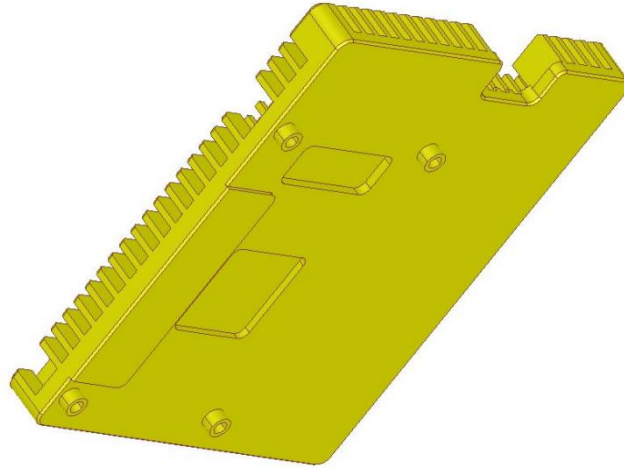

Insert the outer screws first and tighten them just a few turns. Then insert the two inner screws also with a few turns. Now check the gap between carrier and module for other parts than the CPU touching the heatsink. Check the thermal CPU pad for correct position. Tighten the four screws with no more than 30Ncm.

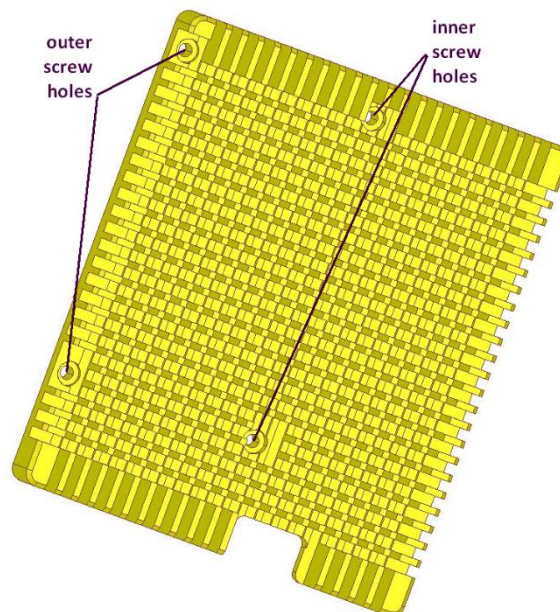

For the removal of the module, first unplug all connections to the system. Take off the inner screws, then the outer ones. The thermal pad may cause the heatsink sticking to the module, so take care, while pulling apart to avoid collisions with any part of the module. Lift the module to about 25° and remove it from the connector. Store the parts on a static free area.

## 6.2 DRAM

The module is fitted with two individual DDR3L memory blocks, each 32bits wide and with 1GByte capacity. The used parts are 4GBit devices organized in 256M x 16 bits with 15 row, 10 column and 3 bank addresses. The refresh rate depends on the operating temperature must be set according to the following table

| Case Temperature           | Refresh Cycle Time |
|----------------------------|--------------------|
| T <sub>c</sub> <85°C       | 7.8us              |
| 85°C<T <sub>c</sub> <95°C  | 3.9us              |
| 95°C<T <sub>c</sub> <105°C | 1.95us             |

The DDR3L command bus is actively terminated and the routed in a fly by structure. The following table shows all trace lengths, in case write leveling should be adjusted. The used layer stack together with the FR4 material causes a signal run time of 6.8ps/mm.

| DRAM  | Signal Group | Trace Length |        | Description |
|-------|--------------|--------------|--------|-------------|
| Bank0 | Command      | J1->J2       | 54.0mm | CPU->DRAM   |
| Bank0 | Command      | J2->J3       | 13.1mm | DRAM->DRAM  |
| Bank0 | Byte 0       | J1->J2       | 25.7mm | CPU->DRAM   |
| Bank0 | Byte 1       | J1->J2       | 22.7mm | CPU->DRAM   |
| Bank0 | Byte 2       | J1->J3       | 23.1mm | CPU->DRAM   |
| Bank0 | Byte 3       | J1->J3       | 18.3mm | CPU->DRAM   |
| Bank1 | Command      | J1->J4       | 54.5mm | CPU->DRAM   |
| Bank1 | Command      | J4->J5       | 13.9mm | DRAM->DRAM  |
| Bank1 | Byte 0       | J1->J4       | 25.3mm | CPU->DRAM   |
| Bank1 | Byte 1       | J1->J4       | 22.9mm | CPU->DRAM   |
| Bank1 | Byte 2       | J1->J5       | 19.0mm | CPU->DRAM   |
| Bank1 | Byte 3       | J1->J5       | 17.2mm | CPU->DRAM   |

### 6.3 eMMC

The local boot device of the MPX-S32V module is realized as an eMMC. The MTFC16GAKAENA-4M-IT from Micron uses the 8-bit wide data bus, provided by the  $\mu$ SDHC module of the S32V234. This interface is shared between the external storage devices on the carrier board and the local eMMC. The selection can be either made by the setting of a CPU GPIO pin or via the MCU. Per default, the multiplexing is done through the MCU by the setting of the boot mode switch.

The reset input of the eMMC device is connected to port PTB7 of the MCU. In case this port is not configured, the FRSTI# signal is tied to +3.3V by a pullup resistor.

### 6.4 Leds

There are four LEDs onboard the MPX-S32V module. The user LEDs 1 and 2 can be controlled by two CPU GPIO pins, led 3 indicates state of the reset line and led 4 is connected to the MCU port PTC3.

| Led | Color  | ON            | OFF          | Description                         |
|-----|--------|---------------|--------------|-------------------------------------|
| LD1 | green  | CPU-PG5=high  | CPU-PG5=low  | LDG1 installed / LDG3 not installed |
| LD2 | green  | CPU-PG6=high  | CPU-PG6=low  | LDG2 installed / LDG4 not installed |
| LD1 | green  | CPU-PB1=high  | CPU-PB1=low  | LDG3 installed / LDG1 not installed |
| LD2 | green  | CPU-PB2=high  | CPU-PB2=low  | LDG4 installed / LDG2 not installed |
| LD3 | red    | RESET#=low    | RESET#=high  | Reset state indicator               |
| LD4 | yellow | MCU-PTC3=high | MCU-PTC3=low | MCU status led                      |

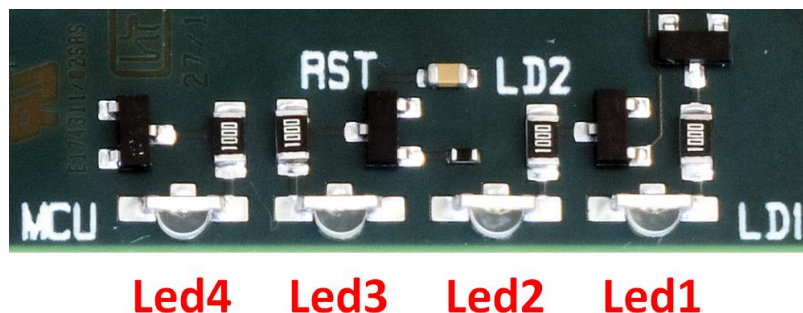

Figure 22: MPX-LEDs

## 6.5 Switches

The sliding switch GPU on the MPX-S32V module is used to disconnect the GPU power pins to reduce power consumption, in case the GPU is not used. The other sliding switch BMD is used to select between RCON controlled and serial boot mode. Both switches are located at the PCB edge on the bottom of the MPX-S32V module.

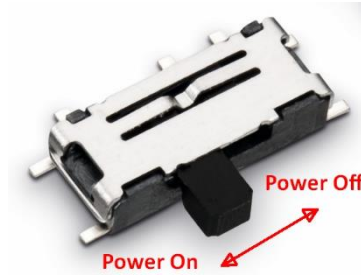

Figure 23: GPU switch

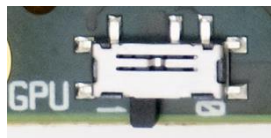

Figure 25: GPU Power On (default)

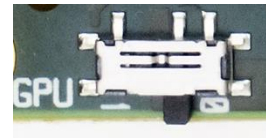
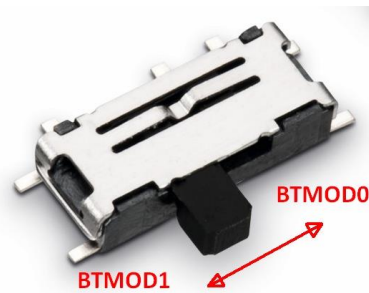

Figure 24: GPU Power Off

Figure 26: BMD Switch



Any handling of these switches must be done exclusively using nonconductive tools to avoid short circuits between carrier board and module.

## 6.6 Module Connector

The carrier board CRX-S32V provides a connector “MXM” which accepts only compatible CPU modules from the MicroSys MPX-S32V-family.

|               |                                 |
|---------------|---------------------------------|
| Manufacturer: | JAE                             |
| Type:         | MM70-314-310-B1-1-R300          |
| Used with:    | MicroSys MPX-S32V module family |

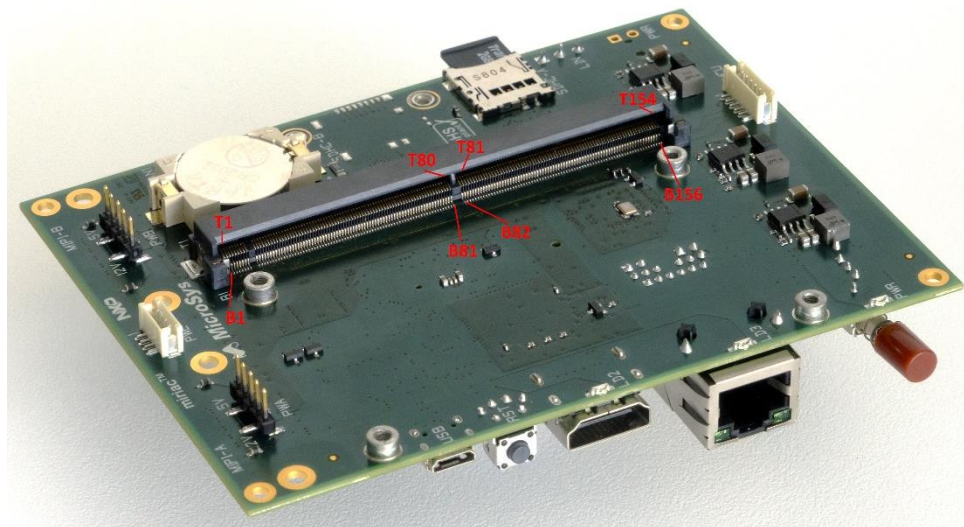

Figure 27: MXM-Connector

## 6.7 Module/Carrier Connections

| MPX-S32V |                  | IO      | CRX-S32V |                   |
|----------|------------------|---------|----------|-------------------|
| Pin      | Signal           | Voltage | Pin      | Signal            |
| B1       | IIC1-SDA         | 3.3V    | B1       | CSI1-SDA (MIPIB)  |
| T1       | GND              |         | T1       | GND               |
| B2       | GND              |         | B2       | GND               |
| T2       | CAN-FD0-TX       | 3.3V    | T2       | CAN-FD0-TX (CAN0) |
| B3       | IIC1-SCL         | 3.3V    | B3       | CSI1-SCL (MIPIB)  |
| T3       | CAN-FD0-RX       | 3.3V    | T3       | CAN-FD0-RX (CAN0) |
| B4       | JTAG-TCK         | 3.3V    | B4       | JTAG-TCK (JTAG)   |
| T4       | GND              |         | T4       | GND               |
| B5       | JTAG-TDI         | 3.3V    | B5       | JTAG-TDI (JTAG)   |
| T5       | CAN-FD1-TX       | 3.3V    | T5       | CAN-FD1-TX (CAN1) |
| B6       | JTAG-TRST#       | 3.3V    | B6       | JTAG-TRST# (JTAG) |
| T6       | CAN-FD1-RX       | 3.3V    | T6       | CAN-FD1-RX (CAN1) |
| B7       | JTAG-TMS         | 3.3V    | B7       | JTAG-TMS (JTAG)   |
| T7       | GND              |         | T7       | GND               |
| B8       | GND              |         | B8       | GND               |
| T8       | CSI1-DT0+        | 1.0V    | T8       | CSI1-DT0+ (MIPIB) |
| B9       | JTAG-TDO         | 3.3V    | B9       | JTAG-TDO (JTAG)   |
| T9       | CSI1-DT0-        | 1.0V    | T9       | CSI1-DT0- (MIPIB) |
| B10      | FLXR-TENB        | 3.3V    | B10      | FLXR-TENB (CAN1)  |
| T10      | GND              |         | T10      | GND               |
| B11      | FLXR-TENA        | 3.3V    | B11      | FLXR-TENA (CAN0)  |
| T11      | CSI1-DT1-        | 1.0V    | T11      | CSI1-DT1- (MIPIB) |
| B12      | FLXR-TXD         | 3.3V    | B12      | FLXR-TXD (LED2)   |
| T12      | CSI1-DT1+        | 1.0V    | T12      | CSI1-DT1+ (MIPIB) |
| B13      | FLXR-RXD         | 3.3V    | B13      | FLXR-RXD (LED3)   |
| T13      | GND              |         | T13      | GND               |
| B14      | GND              |         | B14      | GND               |
| T14      | CSI1-DT2+        | 1.0V    | T14      | CSI1-DT2+ (MIPIB) |
| B15      | 3.3V rail output |         | B15      | +3V3              |
| T15      | CSI1-DT2-        | 1.0V    | T15      | CSI1-DT2- (MIPIB) |
| B16      | 1.8V rail output |         | B16      | +1V8              |
| T16      | GND              |         | T16      | GND               |
| B17      | GND              |         | B17      | GND               |
| T17      | CSI1-DT3-        | 1.0V    | T17      | CSI1-DT3- (MIPIB) |
| B18      | CSI0-CLK+        | 1.0V    | B18      | CSI0-CLK+ (MIPIA) |
| T18      | CSI1-DT3+        | 1.0V    | T18      | CSI1-DT3+ (MIPIB) |
| B19      | CSI0-CLK-        | 1.0V    | B19      | CSI0-CLK- (MIPIA) |
| T19      | GND              |         | T19      | GND               |
| B20      | GND              |         | B20      | GND               |



|     |            |           |     |                   |
|-----|------------|-----------|-----|-------------------|
| T20 | CSI0-DT0+  | 1.0V      | T20 | CSI0-DT0+ (MIPIA) |
| B21 | CSI1-CLK+  | 1.0V      | B21 | CSI1-CLK+ (MIPIB) |
| T21 | CSI0-DT0-  | 1.0V      | T21 | CSI0-DT0- (MIPIA) |
| B22 | CSI1-CLK-  | 1.0V      | B22 | CSI1-CLK- (MIPIB) |
| T22 | GND        |           | T22 | GND               |
| B23 | GND        |           | B23 | GND               |
| T23 | CSI0-DT1-  | 1.0V      | T23 | CSI0-DT1- (MIPIA) |
| B24 | CSI0-DT2+  | 1.0V      | B24 | CSI0-DT2+ (MIPIA) |
| T24 | CSI0-DT1+  | 1.0V      | T24 | CSI0-DT1+ (MIPIA) |
| B25 | CSI0-DT2-  | 1.0V      | B25 | CSI0-DT2- (MIPIA) |
| T25 | GND        |           | T25 | GND               |
| B26 | CSI0-DT3-  | 1.0V      | B26 | CSI0-DT3- (MIPIA) |
| T26 | VIU0-D17   | 3.3V/1.8V | T26 |                   |
| B27 | CSI0-DT3+  | 1.0V      | B27 | CSI0-DT3+ (MIPIA) |
| T27 | VIU0-D18   | 3.3V/1.8V | T27 |                   |
| B28 | GND        |           | B28 | GND               |
| T28 | GND        |           | T28 | GND               |
| B29 | VIU0-D08   | 3.3V/1.8V | B29 |                   |
| T29 | VIU0-D19   | 3.3V/1.8V | T29 |                   |
| B30 | VIU0-D09   | 3.3V/1.8V | B30 |                   |
| T30 | VIU0-D20   | 3.3V/1.8V | T30 |                   |
| B31 | GND        |           | B31 | GND               |
| T31 | GND        |           | T31 | GND               |
| B32 | VIU0-D10   | 3.3V/1.8V | B32 |                   |
| T32 | VIU0-D21   | 3.3V/1.8V | T32 |                   |
| B33 | VIU0-D11   | 3.3V/1.8V | B33 |                   |
| T33 | VIU0-D22   | 3.3V/1.8V | T33 |                   |
| B34 | VIU0-D12   | 3.3V/1.8V | B34 |                   |
| T34 | GND        |           | T34 | GND               |
| B35 | VIU0-D13   | 3.3V/1.8V | B35 |                   |
| T35 | VIU0-D23   | 3.3V/1.8V | T35 |                   |
| B36 | GND        |           | B36 | GND               |
| T36 | VIU0-PCLK  | 3.3V/1.8V | T36 |                   |
| B37 | VIU0-D14   | 3.3V/1.8V | B37 |                   |
| T37 | GND        |           | T37 | GND               |
| B38 | VIU0-D15   | 3.3V/1.8V | B38 |                   |
| T38 | VIU0-VSYNC | 3.3V/1.8V | T38 |                   |
| B39 | VIU0-D16   | 3.3V/1.8V | B39 |                   |
| T39 | VIU0-HSYNC | 3.3V/1.8V | T39 |                   |
| B40 | VIU1-D08   | 3.3V/1.8V | B40 | VIU1-D08 (SDHC-B) |
| T40 | GND        |           | T40 | GND               |
| B41 | GND        |           | B41 | GND               |
| T41 | DCU-B0     | 1.8V      | T41 | DCU-B0 (HDMI)     |
| B42 | VIU1-D09   | 3.3V/1.8V | B42 | VIU1-D09 (SDHC-B) |
| T42 | DCU-B1     | 1.8V      | T42 | DCU-B1 (HDMI)     |
| B43 | VIU1-D10   | 3.3V/1.8V | B43 | VIU1-D10 (SDHC-B) |

|     |            |           |     |                     |
|-----|------------|-----------|-----|---------------------|
| T43 | GND        |           | T43 | GND                 |
| B44 | VIU1-D11   | 3.3V/1.8V | B44 | VIU1-D11 (SDHC-B)   |
| T44 | DCU-B2     | 1.8V      | T44 | DCU-B2 (HDMI)       |
| B45 | VIU1-D12   | 3.3V/1.8V | B45 |                     |
| T45 | DCU-B3     | 1.8V      | T45 | DCU-B3 (HDMI)       |
| B46 | VIU1-D13   | 3.3V/1.8V | B46 |                     |
| T46 | GND        |           | T46 | GND                 |
| B47 | VIU1-D14   | 3.3V/1.8V | B47 |                     |
| T47 | DCU-B4     | 1.8V      | T47 | DCU-B4 (HDMI)       |
| B48 | VIU1-D15   | 3.3V/1.8V | B48 |                     |
| T48 | DCU-B5     | 1.8V      | T48 | DCU-B5 (HDMI)       |
| B49 | VIU1-D16   | 3.3V/1.8V | B49 |                     |
| T49 | GND        |           | T49 | GND                 |
| B50 | GND        |           | B50 | GND                 |
| T50 | DCU-B6     | 1.8V      | T50 | DCU-B6 (HDMI)       |
| B51 | VIU1-D17   | 3.3V/1.8V | B51 |                     |
| T51 | DCU-B7     | 1.8V      | T51 | DCU-B7 (HDMI)       |
| B52 | VIU1-D18   | 3.3V/1.8V | B52 |                     |
| T52 | GND        |           | T52 | GND                 |
| B53 | VIU1-D19   | 3.3V/1.8V | B53 |                     |
| T53 | DCU-DE     | 1.8V      | T53 | DCU-DE (HDMI)       |
| B54 | VIU1-D20   | 3.3V/1.8V | B54 |                     |
| T54 | DCU-PCLK   | 1.8V      | T54 | DCU-PCLK (HDMI)     |
| B55 | GND        |           | B55 | GND                 |
| T55 | GND        |           | T55 | GND                 |
| B56 | VIU1-D21   | 3.3V/1.8V | B56 |                     |
| T56 | DCU-HSYNC  | 1.8V      | T56 | DCU-HSYNC (HDMI)    |
| B57 | VIU1-D22   | 3.3V/1.8V | B57 |                     |
| T57 | DCU-VSYNC  | 1.8V      | T57 | DCU-VSYNC (HDMI)    |
| B58 | VIU1-D23   | 3.3V/1.8V | B58 |                     |
| T58 | GND        |           | T58 | GND                 |
| B59 | VIU1-PCLK  | 3.3V/1.8V | B59 | VIU1-PCLK (SDHC-B)  |
| T59 | DCU-TAG    | 1.8V      | T59 | DCU-TAG (HDMI-EN)   |
| B60 | VIU1-HSYNC | 3.3V/1.8V | B60 | VIU1-HSYNC (SDHC-B) |
| T60 | DCU-G0     | 1.8V      | T60 | DCU-G0 (HDMI)       |
| B61 | VIU1-VSYNC | 3.3V/1.8V | B61 | VIU1-VSYNC (SDHC-B) |
| T61 | GND        |           | T61 | GND                 |
| B62 | DCU-R0     | 1.8V      | B62 | DCU-R0 (HDMI)       |
| T62 | DCU-G1     | 1.8V      | T62 | DCU-G1 (HDMI)       |
| B63 | DCU-R1     | 1.8V      | B63 | DCU-R1 (HDMI)       |
| T63 | DCU-G2     | 1.8V      | T63 | DCU-G2 (HDMI)       |
| B64 | DCU-R2     | 1.8V      | B64 | DCU-R2 (HDMI)       |
| T64 | GND        |           | T64 | GND                 |
| B65 | DCU-R3     | 1.8V      | B65 | DCU-R3 (HDMI)       |
| T65 | DCU-G3     | 1.8V      | T65 | DCU-G3 (HDMI)       |
| B66 | DCU-R4     | 1.8V      | B66 | DCU-R4 (HDMI)       |

|     |           |      |     |                       |
|-----|-----------|------|-----|-----------------------|
| T66 | DCU-G4    | 1.8V | T66 | DCU-G4 (HDMI)         |
| B67 | DCU-R5    | 1.8V | B67 | DCU-R5 (HDMI)         |
| T67 | GND       |      | T67 | GND                   |
| B68 | GND       |      | B68 | GND                   |
| T68 | DCU-G5    | 1.8V | T68 | DCU-G5 (HDMI)         |
| B69 | DCU-R6    | 1.8V | B69 | DCU-R6 (HDMI)         |
| T69 | DCU-G6    | 1.8V | T69 | DCU-G6 (HDMI)         |
| B70 | DCU-R7    | 1.8V | B70 | DCU-R7 (HDMI)         |
| T70 | GND       |      | T70 | GND                   |
| B71 | SDHC-D7   | 3.3V | B71 |                       |
| T71 | DCU-G7    | 1.8V | T71 | DCU-G7 (HDMI)         |
| B72 | SDHC-D6   | 3.3V | B72 |                       |
| T72 |           |      | T72 |                       |
| B73 | GND       |      | B73 | GND                   |
| T73 | GND       |      | T73 | GND                   |
| B74 | SDHC-D5   | 3.3V | B74 |                       |
| T74 | SDHC-D4   | 3.3V | T74 |                       |
| B75 | SDHC-CMD  | 3.3V | B75 | SDHC-CMD (SDHC-A)     |
| T75 | SDHC-D3   | 3.3V | T75 | SDHC-D3 (SDHC-A)      |
| B76 | GND       |      | B76 | GND                   |
| T76 | GND       |      | T76 | GND                   |
| B77 | SDHC-CLK  | 3.3V | B77 | SDHC-CLK (SDHC-A)     |
| T77 | SDHC-D2   | 3.3V | T77 | SDHC-D2 (SDHC-A)      |
| B78 | SDHC-WP   | 3.3V | B78 | SDHC-WP (SDHC-A)      |
| T78 | SDHC-D1   | 3.3V | T78 | SDHC-D1 (SDHC-A)      |
| B79 | GND       |      | B79 | GND                   |
| T79 | GND       |      | T79 | GND                   |
| B80 | SDHC-RST  | 3.3V | B80 |                       |
| T80 | SDHC-D0   | 3.3V | T80 | SDHC-D0 (SDHC-A)      |
| B81 | SDHC-VSEL | 3.3V | B81 |                       |
| T81 | GND       |      | T81 | GND                   |
| B82 | GND       |      | B82 | GND                   |
| T82 | PCIE-TX-  | 1.0V | T82 | PCIE-TX- (mPCIe)      |
| B83 | UART1-TXD | 1.8V | B83 | UART1-TXD (LIN)       |
| T83 | PCIE-TX+  | 1.0V | T83 | PCIE-TX+ (mPCIe)      |
| B84 | UART1-RXD | 1.8V | B84 | UART1-RXD (LIN)       |
| T84 | GND       |      | T84 | GND                   |
| B85 | GND       |      | B85 | GND                   |
| T85 | PCIE-RX-  | 1.0V | T85 | PCIE-RX- (mPCIe)      |
| B86 | UART0-TXD | 3.3V | B86 | UART0-TXD (USB)       |
| T86 | PCIE-RX+  | 1.0V | T86 | PCIE-RX+ (mPCIe)      |
| B87 | UART0-RXD | 3.3V | B87 | UART0-RXD (USB)       |
| T87 | GND       |      | T87 | GND                   |
| B88 | GND       |      | B88 | GND                   |
| T88 | PCIE-CLK+ | 1.0V | T88 | PCIE-CLK+ (mPCIe)     |
| B89 | I2C2-SDA  | 1.8V | B89 | I2C2-SDA (mPCIe,HDMI) |

|      |           |      |      |                       |
|------|-----------|------|------|-----------------------|
| T89  | PCIE-CLK- | 1.0V | T89  | PCIE-CLK- (mPCIe)     |
| B90  | I2C2-SCL  | 1.8V | B90  | I2C2-SCL (mPCIe,HDMI) |
| T90  | GND       |      | T90  | GND                   |
| B91  | SPI3-CS0# | 1.8V | B91  |                       |
| T91  | LFAST-TX- | 1.6V | T91  |                       |
| B92  | SPI3-SCK  | 1.8V | B92  |                       |
| T92  | LFAST-TX+ | 1.6V | T92  |                       |
| B93  | SPI3-SIN  | 1.8V | B93  |                       |
| T93  | GND       |      | T93  | GND                   |
| B94  | SPI3-SOUT | 1.8V | B94  |                       |
| T94  | LFAST-RX- | 1.6V | T94  |                       |
| B95  | SPI0-CS0# | 1.8V | B95  |                       |
| T95  | LFAST-RX+ | 1.6V | T95  |                       |
| B96  | SPI0-SCK  | 1.8V | B96  |                       |
| T96  | GND       |      | T96  | GND                   |
| B97  | SPI0-SIN  | 1.8V | B97  |                       |
| T97  | EMI-MDC   | 1.8V | T97  | EMI-MDC (LAN)         |
| B98  | SPI0-SOUT | 1.8V | B98  |                       |
| T98  | EMI-MDIO  | 1.8V | T98  | EMI-MDIO (LAN)        |
| B99  | SPI1-SIN  | 1.8V | B99  | CSIO-SYN (MIPIA)      |
| T99  | GND       |      | T99  | GND                   |
| B100 | SPI1-SOUT | 1.8V | B100 | CSI1-SYN (MIPIB)      |
| T100 | EC-COL    | 1.8V | T100 | EC-COL (LAN)          |
| B101 | GND       |      | B101 | GND                   |
| T101 | EC-TXCK   | 1.8V | T101 | EC-TXCK (LAN)         |
| B102 | SPI1-SCK  | 1.8V | B102 |                       |
| T102 | GND       |      | T102 | GND                   |
| B103 | SPI1-CS0# | 1.8V | B103 |                       |
| T103 | EC-TXD3   | 1.8V | T103 | EC-TXD3 (LAN)         |
| B104 | FXT0-CH0  | 1.8V | B104 |                       |
| T104 | EC-RXDV   | 1.8V | T104 | EC-RXDV (LAN)         |
| B105 | FXT0-CH1  | 1.8V | B105 | CSIO-RST# (MIPIA)     |
| T105 | GND       |      | T105 | GND                   |
| B106 | FXT0-CH2  | 1.8V | B106 |                       |
| T106 | EC-RXD1   | 1.8V | T106 | EC-RXD1 (LAN)         |
| B107 | GND       |      | B107 | GND                   |
| T107 | EC-TXD2   | 1.8V | T107 | EC-TXD2 (LAN)         |
| B108 | FXT0-CH3  | 1.8V | B108 |                       |
| T108 | GND       |      | T108 | GND                   |
| B109 | FXT1-CH0  | 1.8V | B109 | FXT1-CH0 (MIPIA/B)    |
| T109 | EC-RXD0   | 1.8V | T109 | EC-RXD0 (LAN)         |
| B110 | FXT1-CH1  | 1.8V | B110 | FXT1-CH1 (MIPIA/B)    |
| T110 | EC-CRS    | 1.8V | T110 | EC-CRS (LAN)          |
| B111 | SPI2-SOUT | 1.8V | B111 |                       |
| T111 | GND       |      | T111 | GND                   |
| B112 | GND       |      | B112 | GND                   |

|      |           |      |      |                   |
|------|-----------|------|------|-------------------|
| T112 | EC-RXER   | 1.8V | T112 |                   |
| B113 | SPI2-SCK  | 1.8V | B113 |                   |
| T113 | EC-TXER   | 1.8V | T113 |                   |
| B114 | SPI2-SIN  | 1.8V | B114 | CSI1-RST# (MIPIB) |
| T114 | GND       |      | T114 | GND               |
| B115 | GND       |      | B115 | GND               |
| T115 | EC-RXD3   | 1.8V | T115 | EC-RXD3 (LAN)     |
| B116 | SPI2-CS0# | 1.8V | B116 |                   |
| T116 | EC-TXEN   | 1.8V | T116 | EC-TXEN (LAN)     |
| B117 | ENET-T0   | 1.8V | B117 | CSI0-SDA (MIPIA)  |
| T117 | GND       |      | T117 | GND               |
| B118 | ENET-T1   | 1.8V | B118 | CSI0-SCL (MIPIA)  |
| T118 | EC-RXD2   | 1.8V | T118 | EC-RXD2 (LAN)     |
| B119 | ENET-T2   | 3.3V | B119 |                   |
| T119 | EC-TXD0   | 1.8V | T119 | EC-TXD0 (LAN)     |
| B120 | TRACE-D00 | 1.8V | B120 |                   |
| T120 | GND       |      | T120 | GND               |
| B121 | TRACE-D02 | 1.8V | B121 |                   |
| T121 | EC-RXCK   | 1.8V | T121 | EC-RXCK (LAN)     |
| B122 | TRACE-D04 | 1.8V | B122 |                   |
| T122 | EC-TXD1   | 1.8V | T122 | EC-TXD1 (LAN)     |
| B123 | TRACE-D06 | 1.8V | B123 |                   |
| T123 | GND       |      | T123 | GND               |
| B124 | GND       |      | B124 | GND               |
| T124 | TRACE-CLK | 1.8V | T124 |                   |
| B125 | TRACE-D08 | 1.8V | B125 |                   |
| T125 | TRACE-D01 | 1.8V | T125 |                   |
| B126 | TRACE-D10 | 1.8V | B126 |                   |
| T126 | GND       |      | T126 | GND               |
| B127 | TRACE-D12 | 1.8V | B127 |                   |
| T127 | TRACE-D03 | 1.8V | T127 |                   |
| B128 | TRACE-D14 | 1.8V | B128 |                   |
| T128 | TRACE-D05 | 1.8V | T128 |                   |
| B129 | GND       |      | B129 | GND               |
| T129 | GND       |      | T129 | GND               |
| B130 | BOOT-SEL1 | 3.3V | B130 | BOOT-SEL1 (MCU)   |
| T130 | TRACE-D07 | 1.8V | T130 |                   |
| B131 | BOOT-SEL2 | 3.3V | B131 | BOOT-SEL2 (MCU)   |
| T131 | TRACE-D09 | 1.8V | T131 |                   |
| B132 | RSTIN#    | 3.3V | B132 | RSTIN# (MCU)      |
| T132 | GND       |      | T132 | GND               |
| B133 | VRTC      | 3.3V | B133 | VRTC (RTC)        |
| T133 | TRACE-D11 | 1.8V | T133 |                   |
| B134 | GND       |      | B134 | GND               |
| T134 | TRACE-D13 | 1.8V | T134 |                   |
| B135 | I2C0-SCL  | 3.3V | B135 |                   |

|      |           |      |      |               |
|------|-----------|------|------|---------------|
| T135 | TRACE-D15 | 1.8V | T135 |               |
| B136 | I2C0-SDA  | 3.3V | B136 |               |
| T136 | RSTOUT#   | 3.3V | T136 | RSTOUT# (MCU) |
| B137 | MCU-DIO   | 3.3V | B137 | MCU-DIO (MCU) |
| T137 | GND       |      | T137 | GND           |
| B138 | MCU-CLK   | 3.3V | B138 | MCU-CLK (MCU) |
| T138 | GND       |      | T138 | GND           |
| B139 | GND       |      | B139 | GND           |
| T139 | GND       |      | T139 | GND           |
| B140 | GND       |      | B140 | GND           |
| T140 | GND       |      | T140 | GND           |
| B141 | GND       |      | B141 | GND           |
| T141 | GND       |      | T141 | GND           |
| B142 | GND       |      | B142 | GND           |
| T142 | GND       |      | T142 | GND           |
| B143 | GND       |      | B143 | GND           |
| T143 | GND       |      | T143 | GND           |
| B144 | GND       |      | B144 | GND           |
| T144 | GND       |      | T144 | GND           |
| B145 | GND       |      | B145 | GND           |
| T145 | GND       |      | T145 | GND           |
| B146 | GND       |      | B146 | GND           |
| T146 | +VIN      |      | T146 | +12V          |
| B147 | GND       |      | B147 | GND           |
| T147 | +VIN      |      | T147 | +12V          |
| B148 | +VIN      |      | B148 | +12V          |
| T148 | +VIN      |      | T148 | +12V          |
| B149 | +VIN      |      | B149 | +12V          |
| T149 | +VIN      |      | T149 | +12V          |
| B150 | +VIN      |      | B150 | +12V          |
| T150 | +VIN      |      | T150 | +12V          |
| B151 | +VIN      |      | B151 | +12V          |
| T151 | +VIN      |      | T151 | +12V          |
| B152 | +VIN      |      | B152 | +12V          |
| T152 | +VIN      |      | T152 | +12V          |
| B153 | +VIN      |      | B153 | +12V          |
| T153 | +VIN      |      | T153 | +12V          |
| B154 | +VIN      |      | B154 | +12V          |
| T154 | +VIN      |      | T154 | +12V          |
| B155 | +VIN      |      | B155 | +12V          |
| B156 | +VIN      |      | B156 | +12V          |

Table 4: MXM Connector

# 7 JTAG Chain

## 7.1.1 JTAG Devices

The JTAG chain of the SBC-S32V includes the S32V234 processor only. The JTAG port is directly connected to the connector “JTAG”.

## 7.1.2 JTAG Connector

The JTAG connector provides all standard JTAG signals for an ARM interface on a 2x5 pin header. Pin 7 of this header usually connects the return clock RTCK and is not used on the CRX-S32V. For boundary scan purposes, it can be used to control the TRST# signal. As this feature is not standard due to the 10 pin ARM interface, it can be disconnected by the header JRS. The header JRS is located directly behind the reset push button.

|               |                              |
|---------------|------------------------------|
| Manufacturer: | SAMTEC                       |
| Type:         | 2x5 Pin Header, 1.27mm Pitch |
| Mates with:   | SAMTEC FFSD-05-01-N          |

Table 5 JTAG Header

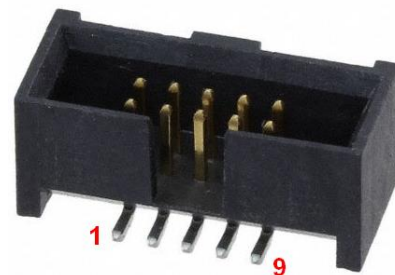
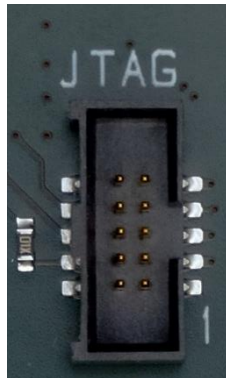
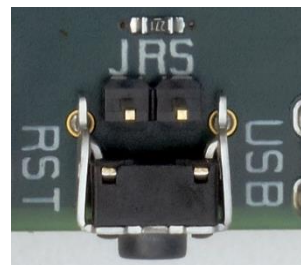

Figure 28: JTAG Connector



Figure 29: TRST Connect



### 7.1.3 JTAG Connector Pinout

| JTAG |        | S32V234 |       | I/O Level | Description |                   |                     |
|------|--------|---------|-------|-----------|-------------|-------------------|---------------------|
| Pin  | Signal | Pin     | Name  |           | Direction   | Function          | Termination         |
| 1    | +3,3V  |         |       |           | Output      | Reference voltage |                     |
| 2    | TMS    | → D9    | TMS   | LVTTTL    | Input       | Test mode select  | 4k7 pullup to +3,3V |
| 3    | GND    |         |       | LVTTTL    |             | Ground            |                     |
| 4    | TCK    | → B9    | TCK   | LVTTTL    | Input       | Clock             | 4k7 pullup to +3,3V |
| 5    | GND    |         |       | LVTTTL    |             | Ground            |                     |
| 6    | TDO    | ← E10   | TDO   | LVTTTL    | Output      | Data out          | 4k7 pullup to +3,3V |
| 7    | Option | → C9    | TRST# | LVTTTL    | Input       | Test Reset        | 4k7 pullup to +3,3V |
| 8    | TDI    | → A18   | TDI   | LVTTTL    | Input       | Data in           | 4k7 pullup to +3,3V |
| 9    | GND    |         |       | LVTTTL    |             | Ground            |                     |
| 10   | RSTIN# | →       |       | LVTTTL    | Input       | System Reset      | 4k7 pullup to +3,3V |



## 8 I<sup>2</sup>C Structure

The SBC-S32V operates on three different I<sup>2</sup>C busses.

I<sup>2</sup>C Bus 0 is only connected to the MIPI-CSI port A, while I<sup>2</sup>C Bus 1 covers the MIPI-CSI port B.

I<sup>2</sup>C Bus 2 controls all other devices on the module and carrier as well as the miniPCIe slot and the HDMI connected devices.

Due to the unpredictable access address of HDMI and miniPCIe slot devices, care must be taken to avoid double addressing with the other I<sup>2</sup>C devices on this bus.

### 8.1.1 Bus Map

I<sup>2</sup>C Bus 0:

| Address   | Reference | Device | Function         |
|-----------|-----------|--------|------------------|
| 0x00-0x7F | ---       | MIPIA  | External devices |

Table 6 I<sup>2</sup>C0 bus map

I<sup>2</sup>C Bus 1:

| Address   | Reference | Device | Function         |
|-----------|-----------|--------|------------------|
| 0x00-0x7F | ---       | MIPIB  | External devices |

Table 7 I<sup>2</sup>C1 bus map

I<sup>2</sup>C Bus 2:

| Address   | Reference        | Device         | Function         |
|-----------|------------------|----------------|------------------|
| 0x51      | J25 [module]     | PCF85263A      | Real Time Clock  |
| 0x3F      | J6 [carrier]     | TFP410P        | HDMI Transmitter |
| 0x00-0x7F | HDMI-A [carrier] | HDMI Connector | DDC              |
| 0x00-0x7F | PCIE-A [carrier] | miniPCIe Slot  | External devices |

Table 8 I<sup>2</sup>C2 bus map

### 8.1.2 I<sup>2</sup>C Devices

#### 8.1.2.1 RTC

The RTC PCF85263A provides year, month, day, weekday, hours, minutes, seconds and 100th seconds. It can be protected against data loss by the backup batterie located on the CRX-S32V carrier.

It is accessible via I<sup>2</sup>C Bus 2 at the 7bit address 0x51. It offers a time stamp input and an interrupt output, which are both connected to the MCU.

#### 8.1.2.2 RTC Backup Battery

The battery holder is designed for CR2032 batteries. The battery type should have a nominal voltage of 3.0V. The backup battery is necessary to keep time and date of the real-time clock on the MPX-S32V module.

|               |                      |
|---------------|----------------------|
| Manufacturer: | Würth                |
| Type:         | 79527141             |
| Used with:    | CR2032 batteries, 3V |



Figure 30: Battery Holder & Battery

### 8.1.3 Digital Visual Interface

The CRX-S32V uses a TFP410PAP as a digital display driver for its HDMI interface. The device is accessible via I<sup>2</sup>C bus 2 at the 7bit address 0x3F. The HDMI port contains a DDC interface which is also connected to the I<sup>2</sup>C bus 2. This DDC interface is disabled after RESET and must be enabled by a low output state of the CPU port PH11, i.e. GPIO[123] or DCU\_TAG. Care must be taken due to the fact, that access addresses of unknown external devices may collide with other devices located on the I<sup>2</sup>C bus 2

# 9 Peripherals

## 9.1 HDMI

The video output of the SBC-S32V is realized with a TFP410 DVI/HDMI interface.

It can be used with a standard type A plug and supports DDC via the I<sup>2</sup>C bus 2. The DDC function can be enabled or disabled via the state of port pin PH11 of the S32V234. Therefore the port PH11 must be configured as general-purpose output.

The hot plug detect feature of the HDMI interface is supported by the TFP410 transmitter through its I<sup>2</sup>C CTL\_2\_MODE register. The TFP410 responds on the I<sup>2</sup>C bus 2 at the address 0x3F.

The CEC feature on pin 13 of the HDMI connector is not supported.



Care must be taken to avoid collisions with other I<sup>2</sup>C devices on bus 2!

### 9.1.1 DDC Function

| PH11/GPIO[123]/DCU-TAG | Pin State | Function     |
|------------------------|-----------|--------------|
| Output                 | low       | DDC enabled  |
| Output                 | high      | DDC disabled |
| Input                  | high      | DDC disabled |
| Reset                  | high      | DDC disabled |

Table 9 DDC Function

### 9.1.2 HDMI Connector

|               |                  |
|---------------|------------------|
| Manufacturer: | Würth Elektronik |
| Type:         | 685119134923     |
| Mates with:   | HDMI Type A      |

Figure 31: HDMI Type A

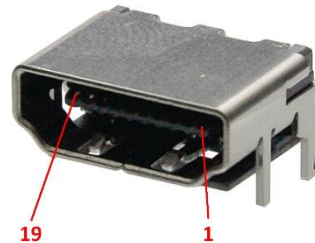

| Pin | Signal      | Description                |
|-----|-------------|----------------------------|
| 1   | TMDS D2+    | Data Pair 2                |
| 2   | TMDS Shield | Data Pair 2 Shield         |
| 3   | TMDS D2-    | Data Pair 2                |
| 4   | TMDS D1+    | Data Pair 1                |
| 5   | TMDS Shield | Data Pair 1 Shield         |
| 6   | TMDS D1-    | Data Pair 1                |
| 7   | TMDS D0+    | Data Pair 0                |
| 8   | TMDS Shield | Data Pair 0 Shield         |
| 9   | TMDS D0-    | Data Pair 0                |
| 10  | TMDS Clock+ | Clock Pair                 |
| 11  | TMDS Shield | Clock Pair Shield          |
| 12  | TMDS Clock- | Clock Pair                 |
| 13  | CEC         | not connected              |
| 14  | reserved.   | not connected              |
| 15  | DDC-SCL     | Display Data Channel Clock |
| 16  | DDC-SDA     | Display Data Channel Data  |
| 17  | GND         | Reference Ground           |
| 18  | +5V         | Supply for external DDC    |
| 19  | HPLG        | Hot Plug Detect            |

## 9.2 LAN Connection

The SBC-S32V system contains a Gigabit LAN interface with 10/100/1000BaseT capability based on the KSZ9031RNX netphy. It works with a RGMII connection and responds on the management address 0x01. The LAN jack contains two LEDs to indicated the actual link and transmit status.

The following picture shows the front view of the connector and its LEDs.

|               |   |
|---------------|---|
| Manufacturer: | Würth Elektronik                              |
| Type:         | 749 911 1221A                                 |
| Mates with:   | RJ45 patch cable, category depending on speed |

Figure 32: LAN-Jack



| Led  | Activity           |
|------|--------------------|
| Led1 | Transmit / Receive |
| Led2 | Link               |

### 9.3 PCIe Interface

The SBC-S32V system offers a single lanes x1 miniPCIe slot. The slot is supplied with +3.3V and +1.5V. Additional voltages, like +5.0V or +12V, are accessible by the power connector PWE1 located between power switch and LAN connector. The power rating for this connector is max.1A per pin.

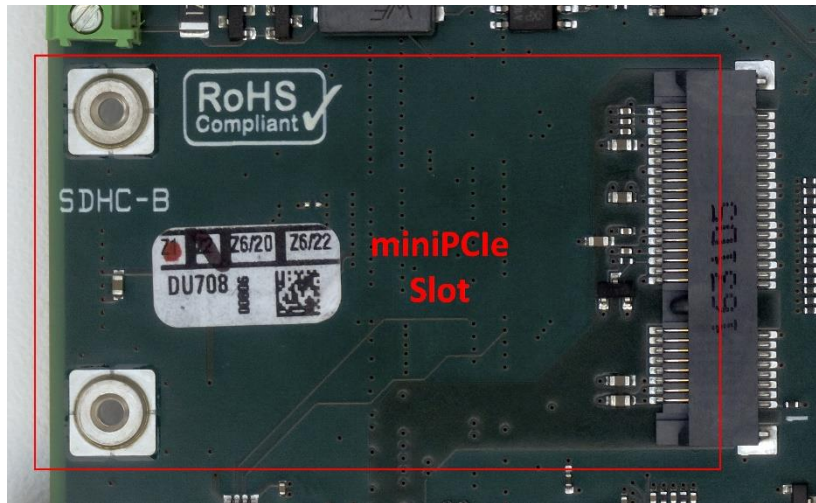

Figure 33: miniPCIe Slot

#### 9.3.1 Power Connector PWE1

|               |              |
|---------------|--------------|
| Manufacturer: | Würth        |
| Type:         | 679304124022 |
| mates with:   | 648004113322 |



Figure 35: Power Connector PWE1

### 9.3.2 The Mini-PCIe Slot

|               |                           |
|---------------|---------------------------|
| Manufacturer: | Tyco                      |
| Type:         | 2041119-1                 |
| Used with:    | Full size mini PCIe cards |

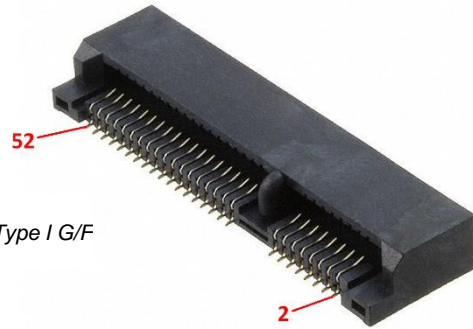

Figure 36: mini PCI-E 4H Type I G/F

| Pin:                  |          |                      | Pin: |
|-----------------------|----------|----------------------|------|
| 1                     | WAKE#    | +3.3V                | 2    |
| 3                     | COEX1    | GND                  | 4    |
| 5                     | COEX2    | +1.5V                | 6    |
| 7                     | CLKREQ#  | UIM-PWR              | 8    |
| 9                     | GND      | UIM-DAT              | 10   |
| 11                    | REFCLK-  | UIM-CLK              | 12   |
| 13                    | REFCLK+  | UIM-RST              | 14   |
| 15                    | GND      | UIM-VPP              | 16   |
| <b>MECHANICAL KEY</b> |          |                      |      |
| 17                    | Reserved | GND                  | 18   |
| 19                    | Reserved | WDIS#                | 20   |
| 21                    | GND      | PERST#               | 22   |
| 23                    | PER0+    | +3.3V                | 24   |
| 25                    | PER0-    | GND                  | 26   |
| 27                    | GND      | +1.5V                | 28   |
| 29                    | GND      | I <sup>2</sup> C-SCL | 30   |
| 31                    | PET0+    | I <sup>2</sup> C-DAT | 32   |
| 33                    | PET0-    | GND                  | 34   |
| 35                    | GND      | USB-D-               | 36   |
| 37                    | GND      | USB-D+               | 38   |
| 39                    | +3.3V    | GND                  | 40   |
| 41                    | +3.3V    | LED-WWAN#            | 42   |
| 43                    | GND      | LED_WLAN#            | 44   |
| 45                    | Reserved | LED_WPAN#            | 46   |
| 47                    | Reserved | +1.5V                | 48   |
| 49                    | Reserved | GND                  | 50   |
| 51                    | Reserved | +3.3V                | 52   |

Table 10 miniPCIe Slot pinout

## 9.4 MIPI CSI Interface

The SBC-S32V offers two serial camera interfaces via the connectors MIPIA and MIPIB (Samtec QSE-020-01-F-D). Each connector contains a four-lane physical layer, compliant with the MIPI Alliance Standard and a clock lane. It also supports multiple cameras using Maxim deserializers.

Both interfaces are supplied with 5.0V and can be configured also for a 12V supply via the two headers PWA and PWB. For more information about the power setting for MIPIA and MIPIB please refer to **4.15.7 MIPI Power**.



**Only a single link per header must be set at a time. More than one link installed may cause permanent damage to the board!**

MIPIA is controlled by I<sup>2</sup>C Bus 0 while MIPIB is handled by I<sup>2</sup>C Bus 1.

Each slot can be controlled by several digital IO lines according to following diagram.

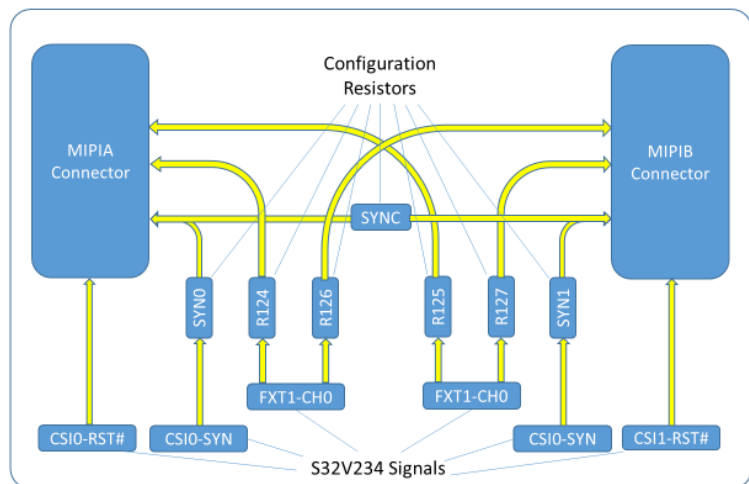
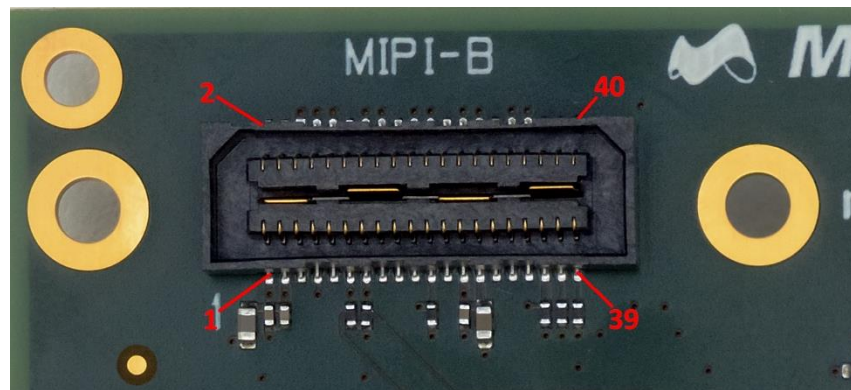
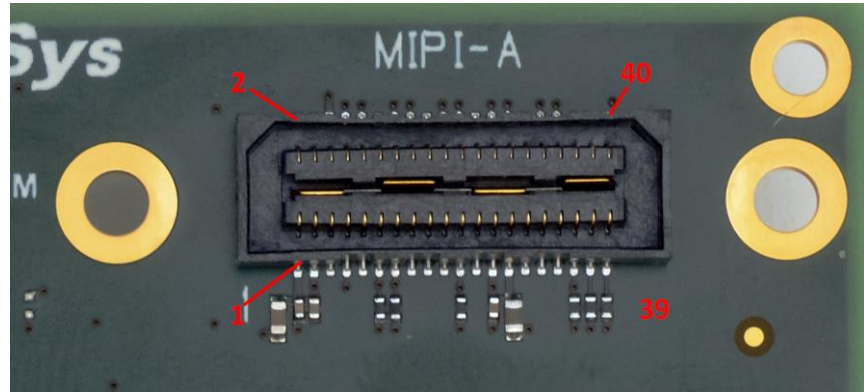

Figure 37: MIPI Configuration



### 9.4.1 MIPI Connectors

|               |                |
|---------------|----------------|
| Manufacturer: | Samtec         |
| Type:         | QSE-020-01-F-D |
| mates with:   | QTE-020-01-F-D |



## 9.4.2 MIPIA Connector

| MIPIA |           | IO      | Description            | S32V234 |
|-------|-----------|---------|------------------------|---------|
| Pin   | Signal    | Voltage |                        | Port    |
| 1     | +5.0V     |         | Supply                 |         |
| 2     | n.c.      |         |                        |         |
| 3     | +5.0V     |         | Supply                 |         |
| 4     | n.c.      |         |                        |         |
| 5     | GND       |         | Reference Ground       |         |
| 6     | GND       |         | Reference Ground       |         |
| 7     | CSIO-CLK  | 1.0V    | 27MHz Clock            |         |
| 8     | CSIO-DT2+ | 1.0V    | MIPI Lane 2            |         |
| 9     | GND       |         | Reference Ground       |         |
| 10    | CSIO-DT2- | 1.0V    | MIPI Lane 2            |         |
| 11    | CSIO-SDA  | 1.8V    | I <sup>2</sup> C Bus 0 | PG3     |
| 12    | GND       |         | Reference Ground       |         |
| 13    | CSIO-SCL  | 1.8V    | I <sup>2</sup> C Bus 0 | PG4     |
| 14    | CSIO-DT0+ | 1.0V    | MIPI Lane 0            |         |
| 15    | n.c.      |         |                        |         |
| 16    | CSIO-DT0- | 1.0V    | MIPI Lane 0            |         |
| 17    | n.c.      |         |                        |         |
| 18    | GND       |         | Reference Ground       |         |
| 19    | n.c.      |         |                        |         |
| 20    | CSIO-CLK+ | 1.0V    | MIPI Clock             |         |
| 21    | CSIO-RST# | 1.8V    | Reset Line             | PC6     |
| 22    | CSIO-CLK- | 1.0V    | MIPI Clock             |         |
| 23    | GND       |         | Reference Ground       |         |
| 24    | GND       |         | Reference Ground       |         |
| 25    | +5V/+12V  |         | Supply via PWA         |         |
| 26    | CSIO-DT1+ | 1.0V    | MIPI Lane 1            |         |
| 27    | +5V/+12V  |         | Supply via PWA         |         |
| 28    | CSIO-DT1- | 1.0V    | MIPI Lane 1            |         |
| 29    | GND       |         | Reference Ground       |         |
| 30    | GND       |         | Reference Ground       |         |
| 31    | n.c.      |         |                        |         |
| 32    | CSIO-DT3+ | 1.0V    | MIPI Lane 3            |         |
| 33    | n.c.      |         |                        |         |
| 34    | CSIO-DT3- | 1.0V    | MIPI Lane 3            |         |
| 35    | CSIO-SYN  | 1.8V    | Sync Line              | PB10    |
| 36    | n.c.      |         |                        |         |
| 37    | FXT1-CH0  | 1.8V    | t.b.d.                 | PC9     |
| 38    | n.c.      |         |                        |         |
| 39    | FXT1-CH1  | 1.8V    | t.b.d.                 | PC10    |
| 40    | n.c.      |         |                        |         |

### 9.4.3 MIPIB Connector

| MIPIB |           | IO      | Description            | S32V234 |
|-------|-----------|---------|------------------------|---------|
| Pin   | Signal    | Voltage |                        | Port    |
| 1     | +5.0V     |         | Supply                 |         |
| 2     | n.c.      |         |                        |         |
| 3     | +5.0V     |         | Supply                 |         |
| 4     | n.c.      |         |                        |         |
| 5     | GND       |         | Reference Ground       |         |
| 6     | GND       |         | Reference Ground       |         |
| 7     | CSI1-CLK  | 1.0V    | 27MHz Clock            |         |
| 8     | CSI1-DT2+ | 1.0V    | MIPI Lane 2            |         |
| 9     | GND       |         | Reference Ground       |         |
| 10    | CSI1-DT2- | 1.0V    | MIPI Lane 2            |         |
| 11    | CSI1-SDA  | 1.8V    | I <sup>2</sup> C Bus 1 | PG5     |
| 12    | GND       |         | Reference Ground       |         |
| 13    | CSI1-SCL  | 1.8V    | I <sup>2</sup> C Bus 1 | PG6     |
| 14    | CSI1-DT0+ | 1.0V    | MIPI Lane 0            |         |
| 15    | n.c.      |         |                        |         |
| 16    | CSI1-DT0- | 1.0V    | MIPI Lane 0            |         |
| 17    | n.c.      |         |                        |         |
| 18    | GND       |         | Reference Ground       |         |
| 19    | n.c.      |         |                        |         |
| 20    | CSI1-CLK+ | 1.0V    | MIPI Clock             |         |
| 21    | CSI1-RST# | 1.8V    | Reset Line             | PB15    |
| 22    | CSI1-CLK- | 1.0V    | MIPI Clock             |         |
| 23    | GND       |         | Reference Ground       |         |
| 24    | GND       |         | Reference Ground       |         |
| 25    | +5V/+12V  |         | Supply via PWB         |         |
| 26    | CSI1-DT1+ | 1.0V    | MIPI Lane 1            |         |
| 27    | +5V/+12V  |         | Supply via PWB         |         |
| 28    | CSI1-DT1- | 1.0V    | MIPI Lane 1            |         |
| 29    | GND       |         | Reference Ground       |         |
| 30    | GND       |         | Reference Ground       |         |
| 31    | n.c.      |         |                        |         |
| 32    | CSI1-DT3+ | 1.0V    | MIPI Lane 3            |         |
| 33    | n.c.      |         |                        |         |
| 34    | CSI1-DT3- | 1.0V    | MIPI Lane 3            |         |
| 35    | CSI1-SYN  | 1.8V    | Sync Line              | PB11    |
| 36    | n.c.      |         |                        |         |
| 37    | FXT1-CH0  | 1.8V    | t.b.d.                 | PC9     |
| 38    | n.c.      |         |                        |         |
| 39    | FXT1-CH1  | 1.8V    | t.b.d.                 | PC10    |
| 40    | n.c.      |         |                        |         |

## 9.5 MicroSD Card Slot

The SBC-S32V system offers two microSD Card interfaces. The microSD card A can also be configured as a boot device. Both SD cards work with 3.3V operation voltage. SD card slot B is a mounting option and not installed in the standard version.

|               |                |
|---------------|----------------|
| Manufacturer: | Yamaichi       |
| Type:         | PJS-008-2130-0 |
| Used with:    | microSD cards  |



Figure 38: micro SD-Card A

microSD card slot A interconnection:

| I/O Range | SDHCA |         |   | S32V234 |         |      |
|-----------|-------|---------|---|---------|---------|------|
|           | Pin   | Name    |   | Pin     | Signal  | Port |
| LVTTTL    | 1     | DAT2    | ↔ | V21     | SD_DAT2 | PK10 |
| LVTTTL    | 2     | CD/DAT3 | ↔ | V22     | SD_DAT3 | PK11 |
| LVTTTL    | 3     | CMD     | ← | U22     | SD_CMD  | PK7  |
|           | 4     | Vdd     |   |         |         |      |
| LVTTTL    | 5     | CLK     | ← | V25     | SD_CLK  | PK6  |
|           | 6     | Vss     |   |         |         |      |
| LVTTTL    | 7     | DAT0    | ↔ | V23     | SD_DAT0 | PK8  |
| LVTTTL    | 8     | DAT1    | ↔ | U23     | SD_DAT1 | PK9  |
| LVTTTL    | 9     | SW1     | → | U25     | SD_WP   | PK5  |

Table 11 microSD card slot pin assignment

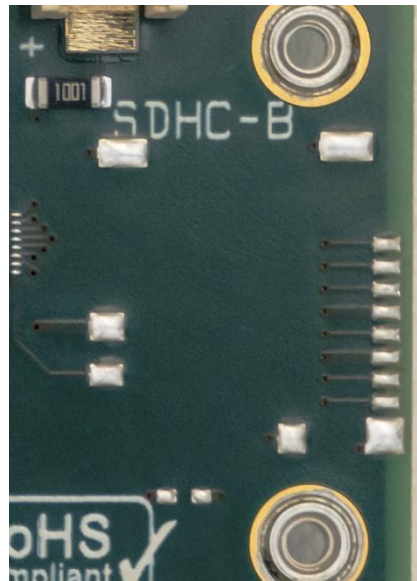

Figure 39: not fitted SDHC-B connector

microSD card slot B interconnection:

| I/O Range | SDHCA |         |   | S32V234 |         |      |
|-----------|-------|---------|---|---------|---------|------|
|           | Pin   | Name    |   | Pin     | Signal  | Port |
| LVTTTL    | 1     | DAT2    | ↔ | N20     | SD_DAT2 | PF5  |
| LVTTTL    | 2     | CD/DAT3 | ↔ | N25     | SD_DAT3 | PF6  |
| LVTTTL    | 3     | CMD     | ← | P22     | SD_CMD  | PF2  |
|           | 4     | Vdd     |   |         |         |      |
| LVTTTL    | 5     | CLK     | ← | P21     | SD_CLK  | PF1  |
|           | 6     | Vss     |   |         |         |      |
| LVTTTL    | 7     | DAT0    | ↔ | M20     | SD_DAT0 | PF3  |
| LVTTTL    | 8     | DAT1    | ↔ | N23     | SD_DAT1 | PF4  |
| LVTTTL    | 9     | SW1     | → | P23     | SD_WP   | PF0  |

Table 12 microSD card slot pin assignment

## 9.6 UART

The SBC-S32V system is provided with two serial UART interfaces.

UART1 is converted to USB 2.0 for easy console port connection with a PC.

UART2 is converted to the LIN 2.1 standard and available on a three-terminal wire connector.

### 9.6.1 UART1

|               |                         |
|---------------|-------------------------|
| Manufacturer: | Würth Elektronik        |
| Type:         | 629 105 150 521         |
| Mates with:   | Standard Micro USB plug |

Figure 40 micro USB

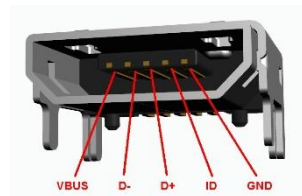

### 9.6.2 UART2

|               |                             |
|---------------|-----------------------------|
| Manufacturer: | Würth Elektronik            |
| Type:         | 691 214 110 003             |
| Mates with:   | 0.2-1.5mm <sup>2</sup> wire |

Figure 41 LIN Connector



## 9.7 CAN

The SBC-S32V system offers two CAN-FD interfaces. CAN0 and CAN1 are accessible via two 2-terminal wire connectors. The necessary 120 ohms end-point termination can be activated by two dip switches

### 9.7.1 CAN0

|               |                             |
|---------------|-----------------------------|
| Manufacturer: | Würth Elektronik            |
| Type:         | 691 214 110 002             |
| Mates with:   | 0.2-1.5mm <sup>2</sup> wire |

Figure 42: CAN0 Terminal Block

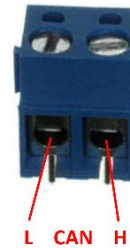

### 9.7.2 CAN1

|               |                             |
|---------------|-----------------------------|
| Manufacturer: | Würth Elektronik            |
| Type:         | 691 214 110 002             |
| Mates with:   | 0.2-1.5mm <sup>2</sup> wire |

Figure 43: CAN1 Terminal Block



### 9.7.3 Termination

The termination is located in the middle behind the terminal blocks. It is activated if the according dip switch is set to ON.

|               |                  |
|---------------|------------------|
| Manufacturer: | Würth Elektronik |
| Type:         | 416131160802     |

Figure 44: CAN Termination Switch

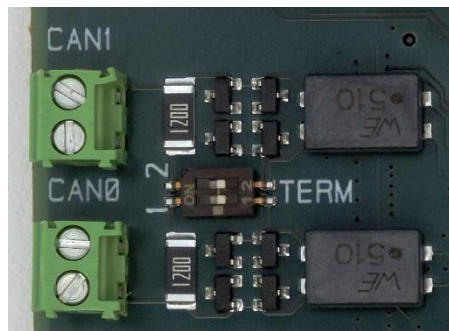

| Setting | TERM-1 | TERM-2 | CAN0             | CAN1             |
|---------|--------|--------|------------------|------------------|
|         | OFF    | OFF    | no termination   | no termination   |
|         | ON     | OFF    | 120R termination | no termination   |
|         | OFF    | ON     | no termination   | 120R termination |
|         | ON     | ON     | 120R termination | 120R termination |



## 9.8 LEDs

The CRX-S32V carrier contains 5 LEDs. There is one power led, two user LEDs and two ethernet traffic indicators. The green power led located underneath the power switch indicates the supply of +12V. The yellow user led, located under the HDMI connector, is connected to the CPU port PA8 and the red user led directly under the LAN jack uses CPU port PA9. The ethernet LEDs are integrated into the RJ45 jack and indicate link status and traffic.

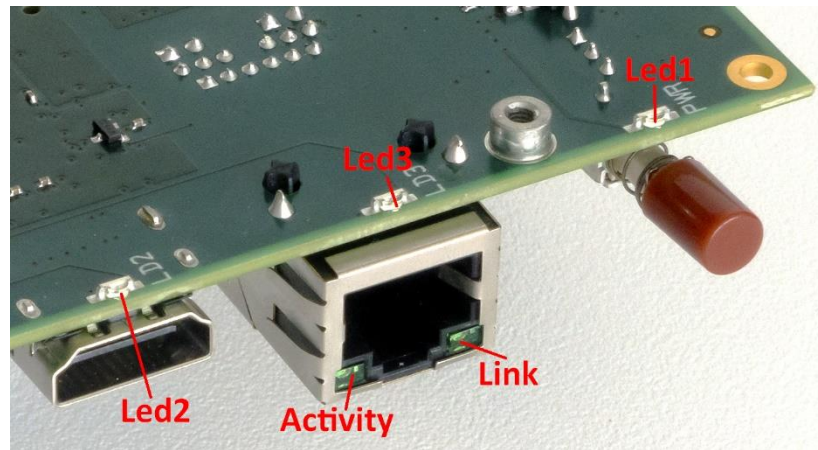

Figure 45: Carrier LEDs

| Led   | Color  | ON                 | OFF              | Description          |
|-------|--------|--------------------|------------------|----------------------|
| LD1   | green  | Power Switch On    | Power Switch Off | +12V applied         |
| LD2   | yellow | CPU-PA8=high       | CPU-PA8=low      | Uses FLXR-TXD signal |
| LD3   | red    | CPU-PA9=high       | CPU-PA9=low      | Uses FLXR-RXD signal |
| LAN-B | yellow | Receive / Transmit | no traffic       | KSZ9031 LED1 Control |
| LAN-C | yellow | Link active        | no link          | KSZ9031 LED2 Control |

## 9.9 Switches

The SBC-S32V contains five switches, three of them are located on the carrier and two on the module. The main power switch PWR, the boot mode switches BOOT and BMD, the CAN termination switch TERM and the GPU power enable switch.

The power switch is an alternate action pushbutton switch to enable or disable power on all power rails for the whole system. For more information refer to **4.15.3 Input Power Switch**.



The boot mode switch is used to select between 4 possible boot configurations, implemented in the MCU. For more information refer to **5.3 Boot Mode Switch** and **5.2 Power Up Configuration**

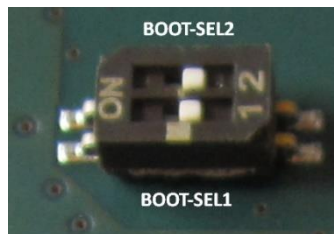

The CAN termination switch is used to enable or disable a 120R termination resistor for each CAN line. For more information refer to **9.7.3 Termination**



The GPU power enable switch is used to reduce power consumption, in case the GPU is not used. For more information refer to chapter **6.5 Switches**



## 9.10 Jumpers

There are three jumper blocks onboard the SBC-S32V.

Two 5 pin headers for MIPI power selection

Figure 46: MIPI-A Power Selection

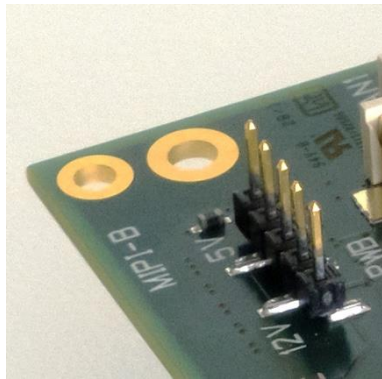
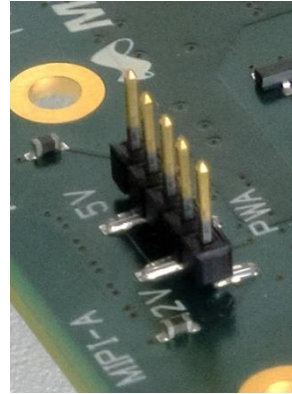

Figure 47: MIPI-B Power Selection



---

**Anyway, only a single link per header must be set at a time. More than one link installed may cause permanent damage to the board!**

---

One 2 pin header for the JTAG configuration

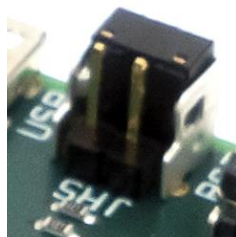

Figure 48: JRS Link

# 10 Appendix

## 10.1 Acronyms

These acronyms are being used within the document; note that this list does not claim to be complete or exhaustive:

|                       |   |
|-----------------------|---|
| ADAS.....             | Advanced Driver Assistance Systems              |
| ARM.....              | Advanced RISC Machine                           |
| BaseT.....            | Ethernet over twisted pair technologies         |
| BIST.....             | Built In Self-Test                              |
| CAN-FD.....           | Controller Area Network with flexible Data rate |
| CEC.....              | Consumer Electronics Control                    |
| Cortex-M4.....        | ARMv7E-M architecture                           |
| CPU.....              | Central Processing Unit                         |
| CR2032.....           | IEC standard button cell                        |
| CSI.....              | Camera Serial Interface                         |
| DDC.....              | Display Data Channel                            |
| eMMC.....             | embedded Multimedia Card                        |
| ESD.....              | Electrostatic Discharge                         |
| FR4.....              | flame retardant 4                               |
| GND.....              | Ground  |
| GPIO.....             | General Purpose IO                              |
| GPL.....              | General Public License                          |
| GPU.....              | Graphic Processing Unit                         |
| HDMI.....             | High-Definition Multimedia Interface            |
| I <sup>2</sup> C..... | Inter-Integrated Circuit                        |
| JTAG.....             | Joint Test Action Group                         |
| Kinetis.....          | ARM® Cortex-M0+ core                            |
| LAN.....              | Local Area Network                              |
| LED.....              | Light Emitting Diode                            |
| LIN.....              | Local Interconnect Network                      |
| MCU.....              | Microcontroller Unit                            |
| MIPI.....             | Mobile Industry Processor Interface             |
| MPX.....              | MicroSys miriac Module                          |
| MXM.....              | Mobile PCI Express Module                       |
| POL.....              | Point Of Load                                   |
| PPTC.....             | Polymeric Positive Temperature Coefficient      |
| RCON.....             | Reset Configuration                             |
| RJ45.....             | Registered Jack 45                              |
| RTC.....              | Real Time Clock                                 |
| SBC.....              | Single Board Computer                           |
| SOM.....              | System On Module                                |
| TFTP.....             | Trivial File Transfer Protocol                  |
| TVS.....              | Transient Voltage Suppressor                    |
| UART.....             | Universal Asynchronous Receiver Transmitter     |
| U-Boot.....           | The Universal Boot Loader                       |
| USB.....              | Universal Serial Bus                            |

## 10.2 Table of Figures

|  |    |
|--|----|
| Figure 1 Boot Switch .....                                   | 10 |
| Figure 2: BMD Switch .....                                   | 10 |
| Figure 3: GPU Switch.....                                    | 10 |
| Figure 4 USB Connector .....                                 | 10 |
| Figure 5 Power Switch Off.....                               | 11 |
| Figure 6 Power Jack .....                                    | 11 |
| Figure 7 Power Switch ON.....                                | 11 |
| Figure 8 Mechanical Dimensions .....                         | 17 |
| Figure 9: Module Side connectors (carrier CRX-S32V).....     | 19 |
| Figure 10 Non-Module Side connectors (carrier CRX-S32V)..... | 20 |
| Figure 11:PN12SHSA03QE .....                                 | 27 |
| Figure 12: G003-Series.....                                  | 27 |
| Figure 13 Power supply structure.....                        | 28 |
| Figure 14: Connector PWE1 & PWE2.....                        | 29 |
| Figure 15: Header PWA & PWB.....                             | 30 |
| Figure 16: BMD Switch .....                                  | 34 |
| Figure 17: Position BTM0=low .....                           | 34 |
| Figure 18: Position BTM1=low .....                           | 34 |
| Figure 19: Boot Mode Switch .....                            | 35 |
| Figure 20: Module MCU Connector.....                         | 37 |
| Figure 21: Carrier MCU Connector .....                       | 38 |
| Figure 22: MPX-Leds .....                                    | 45 |
| Figure 23: GPU switch .....                                  | 46 |
| Figure 24: GPU Power Off .....                               | 46 |
| Figure 25: GPU Power On .....                                | 46 |
| Figure 26: BMD Switch .....                                  | 46 |
| Figure 27: MXM-Connector.....                                | 47 |
| Figure 28: JTAG Connector .....                              | 55 |
| Figure 29: TRST Connect .....                                | 55 |
| Figure 30: Battery Holder & Battery .....                    | 58 |
| Figure 31: HDMI Type A .....                                 | 60 |
| Figure 32: LAN-Jack .....                                    | 61 |
| Figure 33: miniPCIe Slot .....                               | 62 |
| Figure 34: mini PCIe Slot .....                              | 62 |
| Figure 35:Power Conector PWE1 .....                          | 62 |
| Figure 36: mini PCI-E 4H Type I G/F .....                    | 63 |
| Figure 37: MIPI Configuration .....                          | 64 |
| Figure 38: micro SD-Card A.....                              | 68 |
| Figure 39: not fitted SDHC-B connector.....                  | 69 |
| Figure 40 micro USB.....                                     | 70 |
| Figure 41 LIN Connector.....                                 | 70 |
| Figure 42: CAN0 Terminal Block.....                          | 71 |
| Figure 43:CAN1 Terminal Block.....                           | 71 |
| Figure 44: CAN Termination Switch .....                      | 72 |

|   |    |
|---|----|
| Figure 45: Carrier Leds .....           | 73 |
| Figure 46: MIPI-A Power Selection ..... | 76 |
| Figure 47: MIPI-B Power Selection ..... | 76 |
| Figure 48: JRS Link.....                | 76 |

## 10.3 Table of Tables

|  |    |
|--|----|
| Table 1 Symbols .....                          | 6  |
| Table 2 Conventions .....                      | 6  |
| Table 3 Safety and Handling Precautions .....  | 7  |
| Table 4: MXM Connector .....                   | 54 |
| Table 5 JTAG Header .....                      | 55 |
| Table 6 I <sup>2</sup> C0 bus map.....         | 57 |
| Table 7 I <sup>2</sup> C1 bus map.....         | 57 |
| Table 8 I <sup>2</sup> C2 bus map.....         | 57 |
| Table 9 DDC Function.....                      | 59 |
| Table 10 miniPCIe Slot pinout.....             | 63 |
| Table 11 microSD card slot pin assignment..... | 68 |
| Table 12 microSD card slot pin assignment..... | 69 |
| Table 13 Document history .....                | 81 |



# 11 History

| Date       | Version | Change Description   |
|------------|---------|--|
| 2017-07-26 | 1.0     | Initial Release Version (preliminary)  |
| 2017-08-01 | 1.01    | MIPI Chapter and Rev, 2 photos added   |
| 2017-09-01 | 1.1     | Some review inputs implemented. Typos corrected.<br>Default setting for switches marked.<br>Preliminary watermark removed. |
|            |         |  |
|            |         |  |
|            |         |  |
|            |         |  |
|            |         |  |
|            |         |  |
|            |         |  |
|            |         |  |
|            |         |  |
|            |         |  |
|            |         |  |
|            |         |  |

Table 13 Document history



## Стандарт Электрон Связь

Мы молодая и активно развивающаяся компания в области поставок электронных компонентов. Мы поставляем электронные компоненты отечественного и импортного производства напрямую от производителей и с крупнейших складов мира.

Благодаря сотрудничеству с мировыми поставщиками мы осуществляем комплексные и плановые поставки широчайшего спектра электронных компонентов.

Собственная эффективная логистика и склад в обеспечивает надежную поставку продукции в точно указанные сроки по всей России.

Мы осуществляем техническую поддержку нашим клиентам и предпродажную проверку качества продукции. На все поставляемые продукты мы предоставляем гарантию .

Осуществляем поставки продукции под контролем ВП МО РФ на предприятия военно-промышленного комплекса России , а также работаем в рамках 275 ФЗ с открытием отдельных счетов в уполномоченном банке. Система менеджмента качества компании соответствует требованиям ГОСТ ISO 9001.

Минимальные сроки поставки, гибкие цены, неограниченный ассортимент и индивидуальный подход к клиентам являются основой для выстраивания долгосрочного и эффективного сотрудничества с предприятиями радиоэлектронной промышленности, предприятиями ВПК и научно-исследовательскими институтами России.

С нами вы становитесь еще успешнее!

### Наши контакты:

**Телефон:** +7 812 627 14 35

**Электронная почта:** [sales@st-electron.ru](mailto:sales@st-electron.ru)

**Адрес:** 198099, Санкт-Петербург,  
Промышленная ул, дом № 19, литера Н,  
помещение 100-Н Офис 331