



Three Phase Bridge (Power Modules), 90 A/110 A



MT-K

FEATURES

- Package fully compatible with the industry standard INT-A-PAK power modules series
- High thermal conductivity package, electrically insulated case
- Excellent power volume ratio, outline for easy connections to power transistor and IGBT modules
- 4000 V_{RMS} isolating voltage
- UL E78996 approved 
- Designed and qualified for industrial level
- Material categorization: For definitions of compliance please see www.vishay.com/doc?99912



RoHS COMPLIANT

| PRODUCT SUMMARY | |
|------------------|--------------------|
| I _O | 90 A to 110 A |
| V _{RRM} | 800 V to 1600 V |
| Package | MT-K |
| Circuit | Three phase bridge |

DESCRIPTION

A range of extremely compact, encapsulated three phase bridge rectifiers offering efficient and reliable operation. They are intended for use in general purpose and heavy duty applications.

| MAJOR RATINGS AND CHARACTERISTICS | | | | |
|-----------------------------------|-----------------|-------------|-----------|-------------------|
| SYMBOL | CHARACTERISTICS | 90MT.K | 110MT.K | UNITS |
| I _O | | 90 (120) | 110 (150) | A |
| | T _C | 90 (61) | 90 (57) | °C |
| I _{FSM} | 50 Hz | 770 | 950 | A |
| | 60 Hz | 810 | 1000 | |
| I ² t | 50 Hz | 3000 | 4500 | A ² s |
| | 60 Hz | 2700 | 4100 | |
| I ² √t | | 30 000 | 45 000 | A ² √s |
| V _{RRM} | Range | 800 to 1600 | | V |
| T _{Stg} | Range | -40 to 150 | | °C |
| T _J | | | | |

ELECTRICAL SPECIFICATIONS

| VOLTAGE RATINGS | | | | |
|-----------------|--------------|---|---|---|
| TYPE NUMBER | VOLTAGE CODE | V _{RRM} , MAXIMUM REPETITIVE PEAK REVERSE VOLTAGE V | V _{RSM} , MAXIMUM NON-REPETITIVE PEAK REVERSE VOLTAGE V | I _{RRM} MAXIMUM AT T _J = MAXIMUM mA |
| VS-90-110MT..K | 80 | 800 | 900 | 10 |
| | 100 | 1000 | 1100 | |
| | 120 | 1200 | 1300 | |
| | 140 | 1400 | 1500 | |
| | 160 | 1600 | 1700 | |



| FORWARD CONDUCTION | | | | | | | |
|---|---------------------|--|-----------------------------------|--|-----------|-------------------|------------------|
| PARAMETER | SYMBOL | TEST CONDITIONS | | 90MT.K | 110MT.K | UNITS | |
| Maximum DC output current at case temperature | I _O | 120° rect. conduction angle | | 90 (120) | 110 (150) | A | |
| | | | | 90 (61) | 90 (57) | °C | |
| Maximum peak, one-cycle forward, non-repetitive surge current | I _{FSM} | t = 10 ms | No voltage reappplied | Initial T _J = T _J maximum | 770 | 950 | A |
| | | t = 8.3 ms | | | 810 | 1000 | |
| | | t = 10 ms | 100 % V _{RRM} reappplied | | 650 | 800 | |
| | | t = 8.3 ms | | | 680 | 840 | |
| Maximum I ² t for fusing | I ² t | t = 10 ms | No voltage reappplied | Initial T _J = T _J maximum | 3000 | 4500 | A ² s |
| | | t = 8.3 ms | | | 2700 | 4100 | |
| | | t = 10 ms | 100 % V _{RRM} reappplied | | 2100 | 3200 | |
| | | t = 8.3 ms | | | 1900 | 2900 | |
| Maximum I ² √t for fusing | I ² √t | t = 0.1 ms to 10 ms, no voltage reappplied | | 30 000 | 45 000 | A ² √s | |
| Low level value of threshold voltage | V _{F(TO)1} | (16.7 % × π × I _{F(AV)} < I < π × I _{F(AV)}), T _J maximum | | 0.89 | 0.81 | V | |
| High level value of threshold voltage | V _{F(TO)2} | (I > π × I _{F(AV)}), T _J maximum | | 1.05 | 0.99 | | |
| Low level value of forward slope resistance | r _{f1} | (16.7 % × π × I _{F(AV)} < I < π × I _{F(AV)}), T _J maximum | | 5.11 | 4.37 | mΩ | |
| High level value of forward slope resistance | r _{f2} | (I > π × I _{F(AV)}), T _J maximum | | 4.64 | | | |
| Maximum forward voltage drop | V _{FM} | I _{pk} = 150 A, T _J = 25 °C t _p = 400 μs single junction | | 1.6 | 1.4 | V | |
| RMS isolation voltage | V _{ISOL} | T _J = 25 °C, all terminal shorted f = 50 Hz, t = 1 s | | 4000 | | | |

| THERMAL AND MECHANICAL SPECIFICATIONS | | | | | | |
|--|-----------------------------------|--|--|------------|---------|-------|
| PARAMETER | SYMBOL | TEST CONDITIONS | | 90MT.K | 110MT.K | UNITS |
| Maximum junction operating and storage temperature range | T _J , T _{Stg} | | | -40 to 150 | | °C |
| Maximum thermal resistance, junction to case | R _{thJC} | DC operation per module | | 0.21 | 0.18 | °C/W |
| | | DC operation per junction | | 1.26 | 1.07 | |
| | | 120° rect. conduction angle per module | | 0.25 | 0.21 | |
| | | 120° rect. conduction angle per junction | | 1.47 | 1.25 | |
| Maximum thermal resistance, case to heatsink per module | R _{thCS} | Mounting surface smooth, flat and greased | | 0.03 | | |
| Mounting torque ± 10 % | to heatsink to terminal | A mounting compound is recommended and the torque should be rechecked after a period of 3 hours to allow for the spread of the compound. Lubricated threads. | | 4 to 6 | | Nm |
| | | | | 3 to 4 | | |
| Approximate weight | | | | 176 | | g |

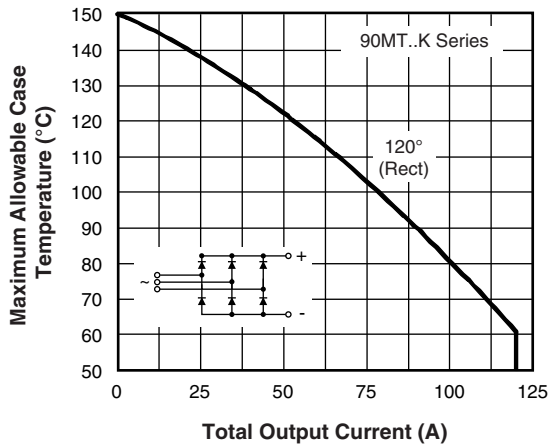

Fig. 1 - Current Ratings Characteristics

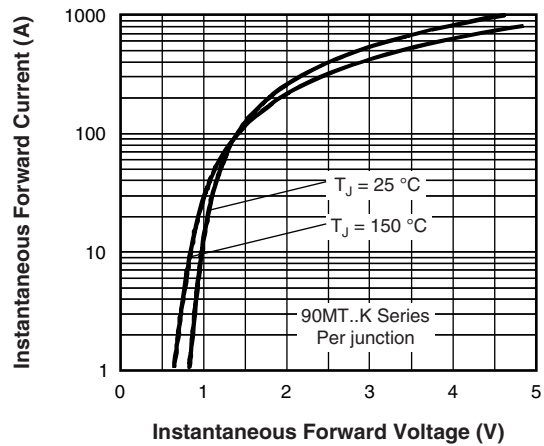

Fig. 2 - Forward Voltage Drop Characteristics

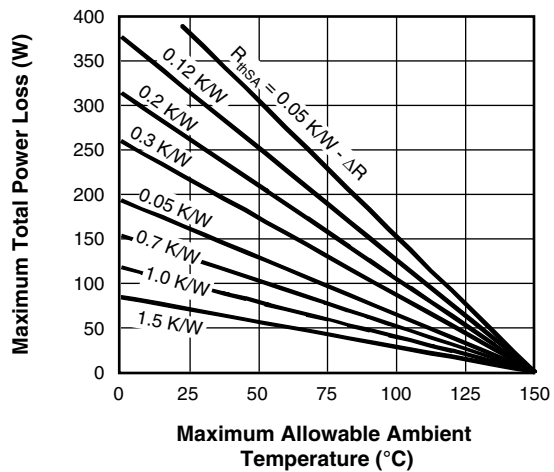
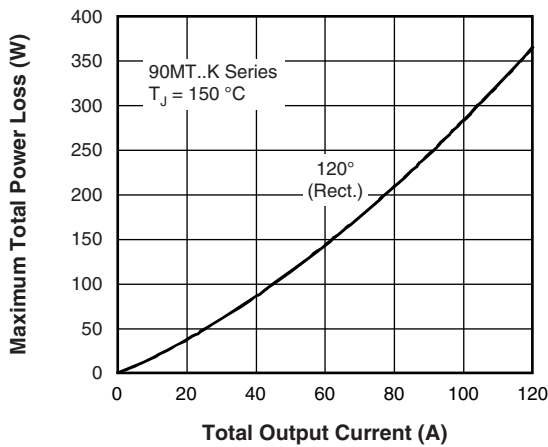

Fig. 3 - Total Power Loss Characteristics

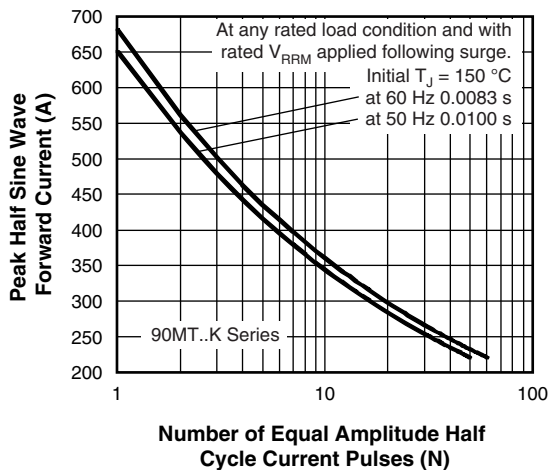

Fig. 4 - Maximum Non-Repetitive Surge Current

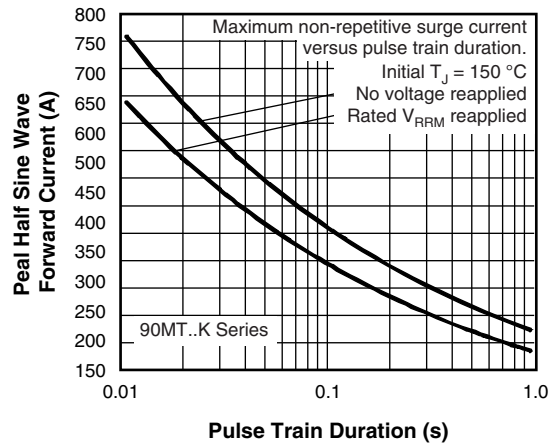

Fig. 5 - Maximum Non-Repetitive Surge Current

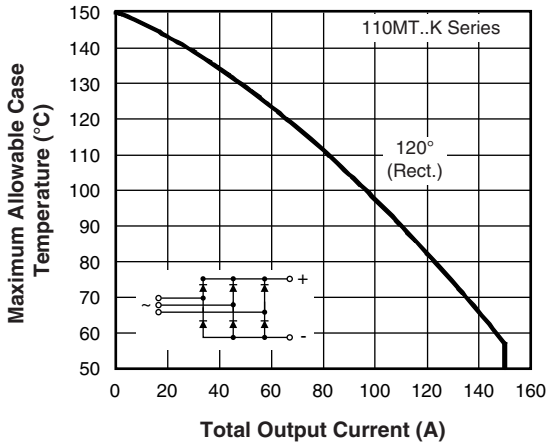

Fig. 6 - Current Ratings Characteristics

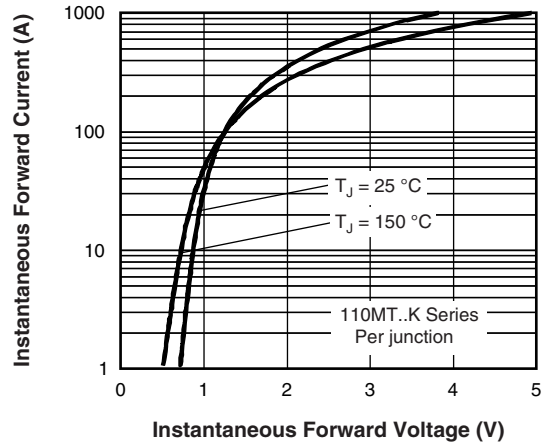

Fig. 7 - Forward Voltage Drop Characteristics

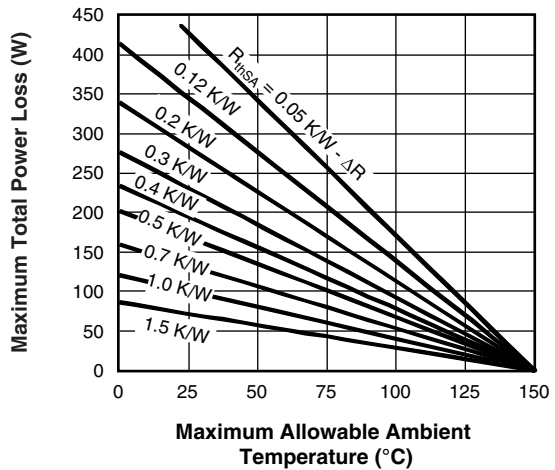
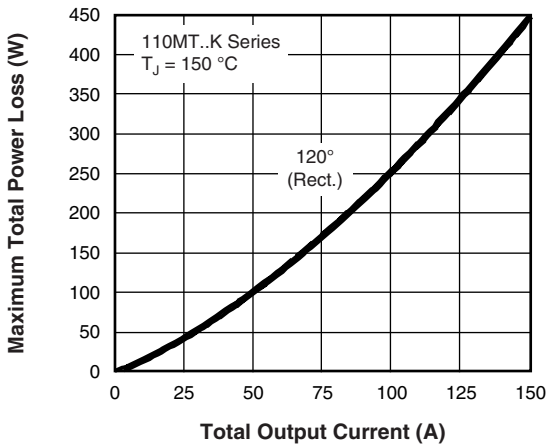

Fig. 8 - Total Power Loss Characteristics

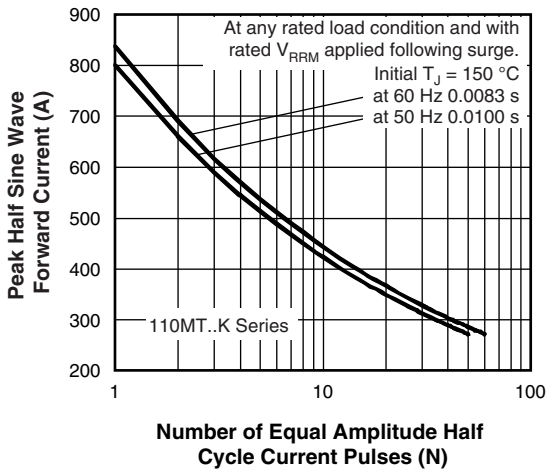

Fig. 9 - Maximum Non-Repetitive Surge Current

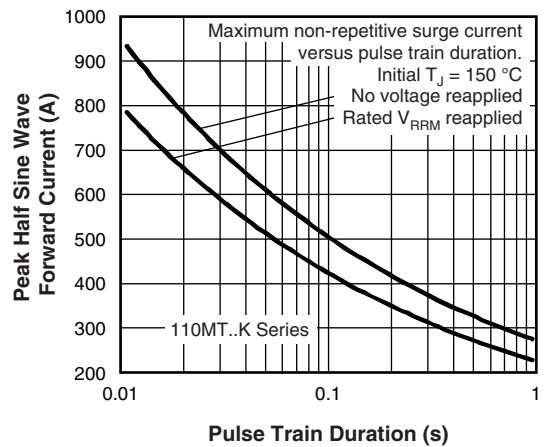

Fig. 10 - Maximum Non-Repetitive Surge Current

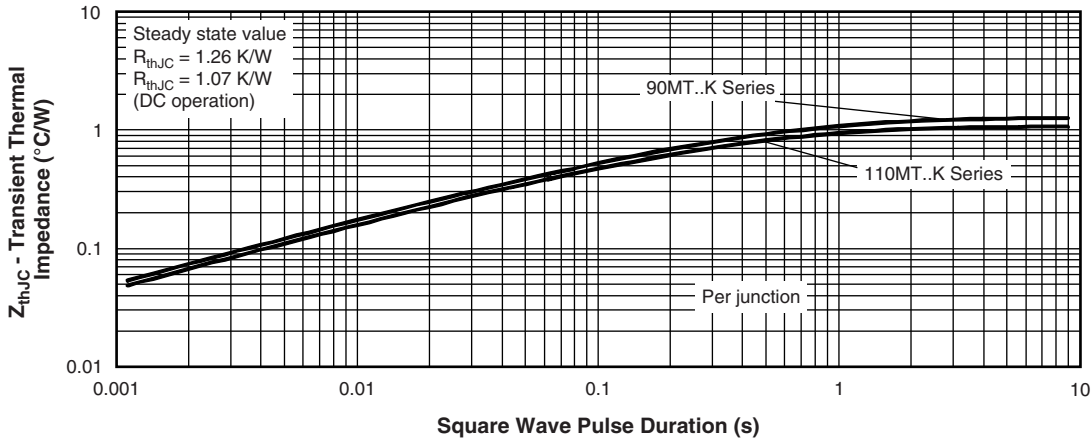

Fig. 11 - Thermal Impedance Z_{thJC} Characteristic

ORDERING INFORMATION TABLE

| | | | | | | | |
|-------------|------------|-----------|----------|-----------|------------|----------|------------|
| Device code | VS- | 11 | 0 | MT | 160 | K | PbF |
| | ① | ② | ③ | ④ | ⑤ | ⑥ | ⑥ |

- 1** - Vishay Semiconductors product
- 2** - Current rating code: 9 = 90 A (average)
11 = 110 A (average)
- 3** - Three phase diodes bridge
- 4** - Essential part number
- 5** - Voltage code x 10 = V_{RRM} (see Voltage Ratings table)
- 6** - PbF = Lead (Pb)-free

Note

- To order the optional hardware go to www.vishay.com/doc?95172

CIRCUIT CONFIGURATION

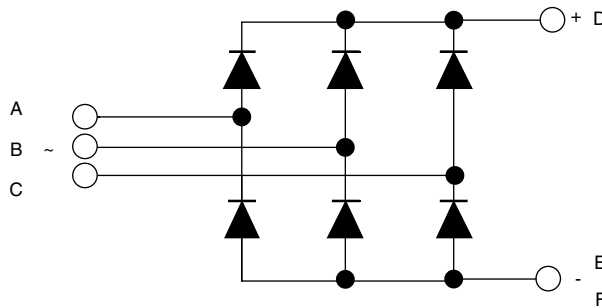

| LINKS TO RELATED DOCUMENTS | |
|----------------------------|--|
| Dimensions | www.vishay.com/doc?95004 |

MTK (with and without optional barrier)

DIMENSIONS WITH OPTIONAL BARRIERS in millimeters (inches)

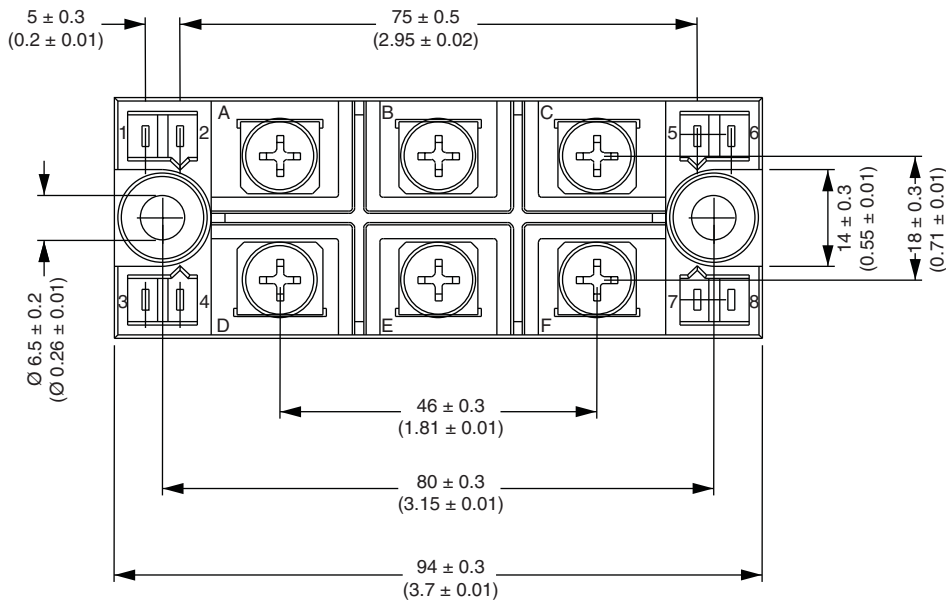
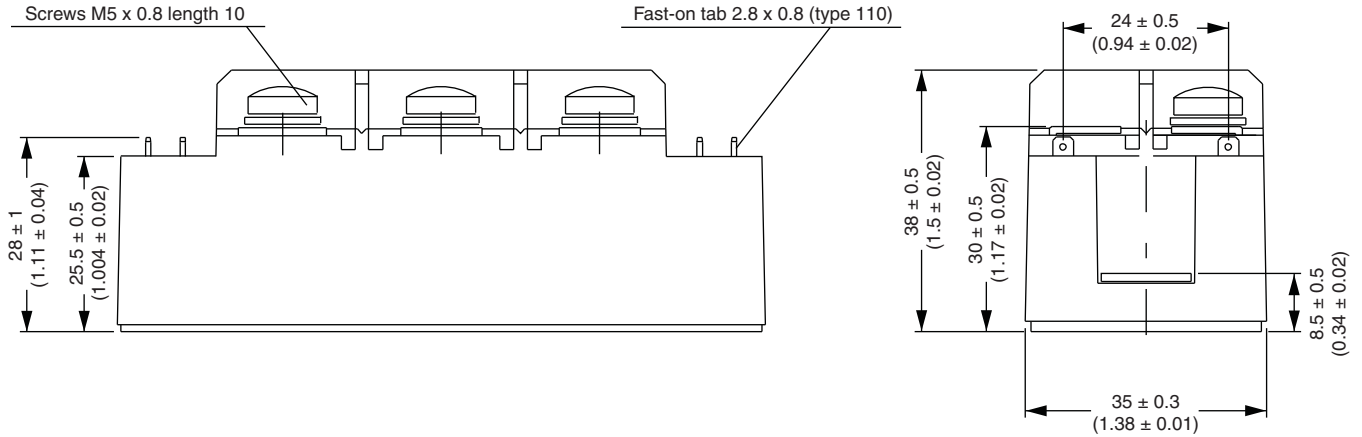

Outline Dimensions

Vishay Semiconductors MTK (with and without optional barrier)



DIMENSIONS WITHOUT OPTIONAL BARRIERS in millimeters (inches)





Disclaimer

ALL PRODUCT, PRODUCT SPECIFICATIONS AND DATA ARE SUBJECT TO CHANGE WITHOUT NOTICE TO IMPROVE RELIABILITY, FUNCTION OR DESIGN OR OTHERWISE.

Vishay Intertechnology, Inc., its affiliates, agents, and employees, and all persons acting on its or their behalf (collectively, "Vishay"), disclaim any and all liability for any errors, inaccuracies or incompleteness contained in any datasheet or in any other disclosure relating to any product.

Vishay makes no warranty, representation or guarantee regarding the suitability of the products for any particular purpose or the continuing production of any product. To the maximum extent permitted by applicable law, Vishay disclaims (i) any and all liability arising out of the application or use of any product, (ii) any and all liability, including without limitation special, consequential or incidental damages, and (iii) any and all implied warranties, including warranties of fitness for particular purpose, non-infringement and merchantability.

Statements regarding the suitability of products for certain types of applications are based on Vishay's knowledge of typical requirements that are often placed on Vishay products in generic applications. Such statements are not binding statements about the suitability of products for a particular application. It is the customer's responsibility to validate that a particular product with the properties described in the product specification is suitable for use in a particular application. Parameters provided in datasheets and/or specifications may vary in different applications and performance may vary over time. All operating parameters, including typical parameters, must be validated for each customer application by the customer's technical experts. Product specifications do not expand or otherwise modify Vishay's terms and conditions of purchase, including but not limited to the warranty expressed therein.

Except as expressly indicated in writing, Vishay products are not designed for use in medical, life-saving, or life-sustaining applications or for any other application in which the failure of the Vishay product could result in personal injury or death. Customers using or selling Vishay products not expressly indicated for use in such applications do so at their own risk. Please contact authorized Vishay personnel to obtain written terms and conditions regarding products designed for such applications.

No license, express or implied, by estoppel or otherwise, to any intellectual property rights is granted by this document or by any conduct of Vishay. Product names and markings noted herein may be trademarks of their respective owners.

Material Category Policy

Vishay Intertechnology, Inc. hereby certifies that all its products that are identified as RoHS-Compliant fulfill the definitions and restrictions defined under Directive 2011/65/EU of The European Parliament and of the Council of June 8, 2011 on the restriction of the use of certain hazardous substances in electrical and electronic equipment (EEE) - recast, unless otherwise specified as non-compliant.

Please note that some Vishay documentation may still make reference to RoHS Directive 2002/95/EC. We confirm that all the products identified as being compliant to Directive 2002/95/EC conform to Directive 2011/65/EU.

Vishay Intertechnology, Inc. hereby certifies that all its products that are identified as Halogen-Free follow Halogen-Free requirements as per JEDEC JS709A standards. Please note that some Vishay documentation may still make reference to the IEC 61249-2-21 definition. We confirm that all the products identified as being compliant to IEC 61249-2-21 conform to JEDEC JS709A standards.



**Стандарт
Электрон
Связь**

Мы молодая и активно развивающаяся компания в области поставок электронных компонентов. Мы поставляем электронные компоненты отечественного и импортного производства напрямую от производителей и с крупнейших складов мира.

Благодаря сотрудничеству с мировыми поставщиками мы осуществляем комплексные и плановые поставки широчайшего спектра электронных компонентов.

Собственная эффективная логистика и склад в обеспечивает надежную поставку продукции в точно указанные сроки по всей России.

Мы осуществляем техническую поддержку нашим клиентам и предпродажную проверку качества продукции. На все поставляемые продукты мы предоставляем гарантию .

Осуществляем поставки продукции под контролем ВП МО РФ на предприятия военно-промышленного комплекса России , а также работаем в рамках 275 ФЗ с открытием отдельных счетов в уполномоченном банке. Система менеджмента качества компании соответствует требованиям ГОСТ ISO 9001.

Минимальные сроки поставки, гибкие цены, неограниченный ассортимент и индивидуальный подход к клиентам являются основой для выстраивания долгосрочного и эффективного сотрудничества с предприятиями радиоэлектронной промышленности, предприятиями ВПК и научно-исследовательскими институтами России.

С нами вы становитесь еще успешнее!

Наши контакты:

Телефон: +7 812 627 14 35

Электронная почта: sales@st-electron.ru

Адрес: 198099, Санкт-Петербург,
Промышленная ул, дом № 19, литера Н,
помещение 100-Н Офис 331