

# Analog Devices Welcomes Hittite Microwave Corporation

NO CONTENT ON THE ATTACHED DOCUMENT HAS CHANGED



**THIS PAGE INTENTIONALLY LEFT BLANK**

### Typical Applications

The HMC6147ALC5A is ideal for:

- Point-to-Point and Point-to-Multi-Point Radio
- Military Radar, EW & ELINT
- Satellite Communications
- Sensors

### Features

- Conversion Gain: 13 dB
- Excellent Image Rejection: 25 dB
- Output IP3: +12 dBm
- 16 Lead 5x5 mm SMT Ceramic Package: 25 mm<sup>2</sup>

### Functional Diagram

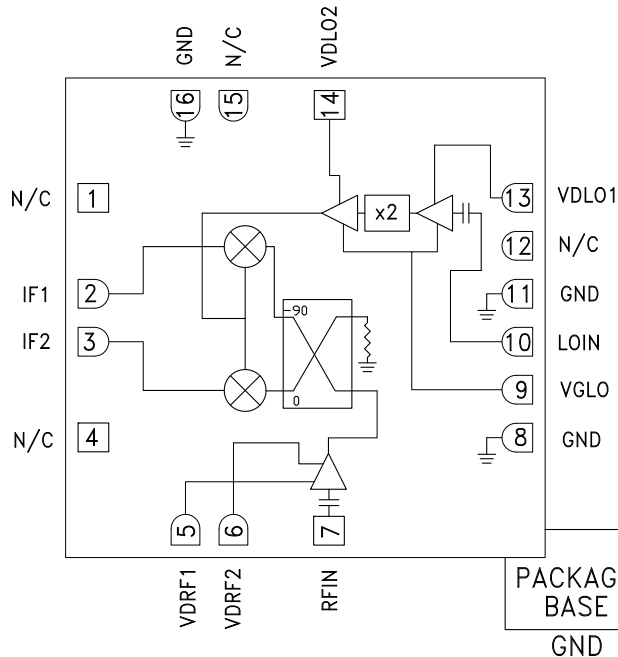

### General Description

The HMC6147ALC5A is a compact GaAs MMIC I/Q downconverter in a leadless RoHS compliant SMT package. This device provides a small signal conversion gain of 13 dB with 25 dBc of sideband rejection. The HMC6147ALC5A utilizes a low noise amplifier to drive the I/Q mixer where the LO is driven by a X2 multiplier. IF1 and IF2 mixer inputs are provided and an external 90° hybrid is needed to select the required sideband. The I/Q mixer topology reduces the need for filtering of the unwanted sideband. The HMC6147ALC5A is a much smaller alternative to hybrid style single sideband converter assemblies and it eliminates the need for wire bonding by allowing the use of surface mount manufacturing techniques.

**Electrical Specifications** <sup>[1][2]</sup>,  $T_A = +25^\circ\text{C}$ ,  $IF = 1000\text{ MHz}$ ,  
 $LO = +3\text{ dBm}$ ,  $VDLO1,2 = +3V$ ,  $IDLO1,2 = 150\text{ mA}$ ,  $VDRF1,2 = +3V$ ,  $IDRF1,2 = 75\text{ mA}$ ,  $USB$  <sup>[1][2]</sup>

Parameter	Min.	Typ.	Max.	Units
Frequency Range, RF		37 - 44		GHz
Frequency Range, LO		16.5 - 22		GHz
Frequency Range, IF		0 - 4		GHz
Conversion Gain	10	13		dB
Image Rejection	15	25		dBc
1 dB Compression (Output)		1		dBm
IP3 (Input)		2		dBm
Noise Figure		3.5		dB
Supply Current IDLO1 + IDLO2 quiescent <sup>[2]</sup>		150		mA
Supply Current IDRFB1 + IDRFB2		75		mA

[1] Unless otherwise noted all measurements performed with low side LO, IF = 1000 MHz and external IF 90° hybrid.

[2] Adjust Vgg between -2 to 0V to achieve IDLO1 + IDLO2 = 150 mA Typical with RF turned off.



**GaAs MMIC I/Q DOWNCONVERTER  
37 - 44 GHz**

*Data Taken as SSB Downconverter with External IF 90° Hybrid, IF = 1000 MHz*

**Conversion Gain, USB vs. Temperature**

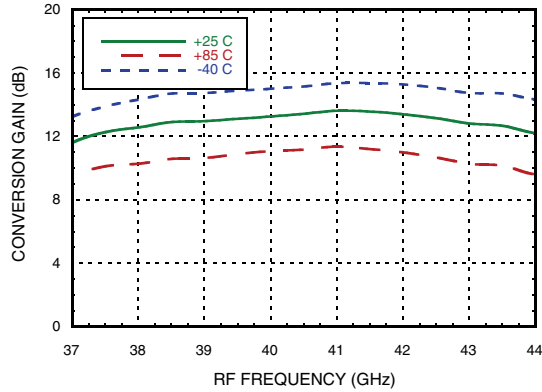

**Conversion Gain, USB vs. LO Drive**

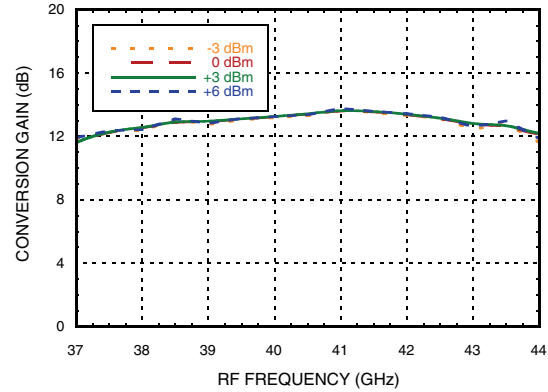

**Image Rejection vs. Temperature**

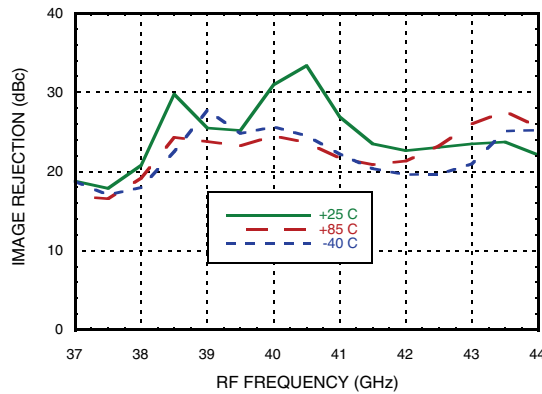

**RF Return Loss**

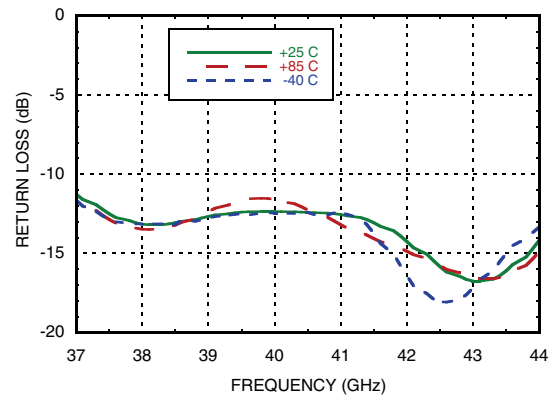

**LO Return Loss vs. Temperature**

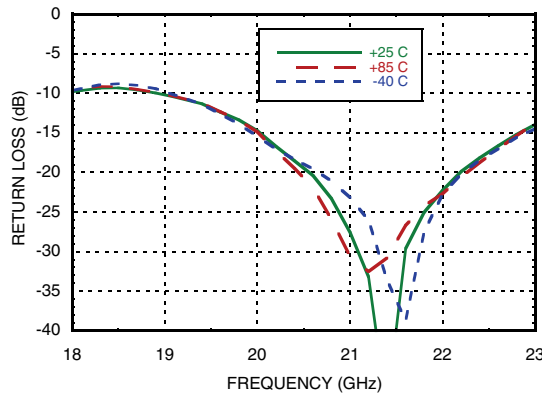

**IF Return Loss [1]**

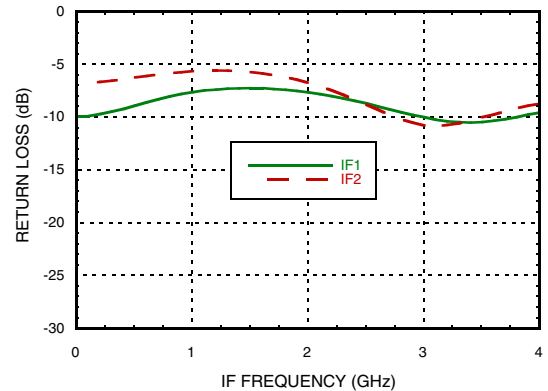

[1] Data taken without external IF 90° hybrid



## GaAs MMIC I/Q DOWNCONVERTER 37 - 44 GHz

Data Taken as SSB Downconverter with External IF 90° Hybrid, IF = 1000 MHz

**LO Isolation**

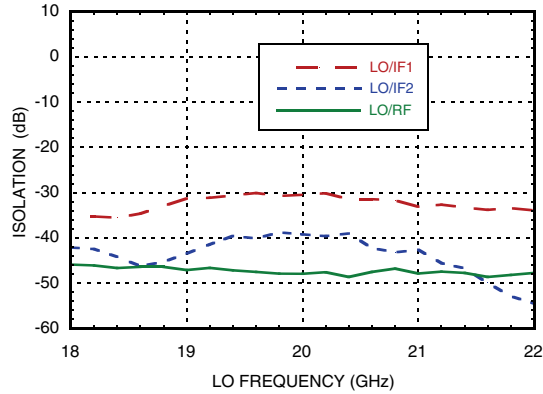

**2LO Isolation**

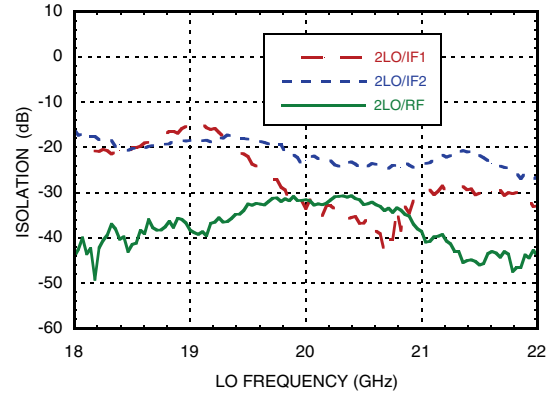

**Input P1dB, USB vs. Temperature**

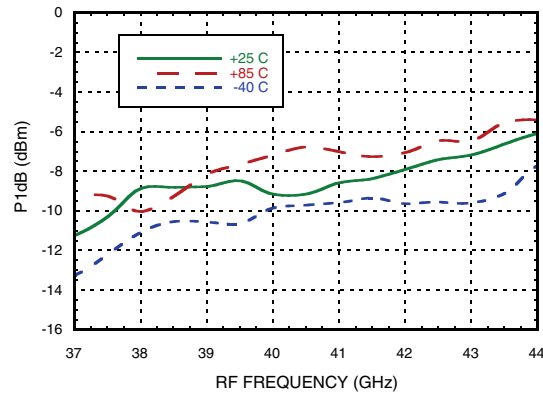

**Output P1dB, USB vs. Temperature**

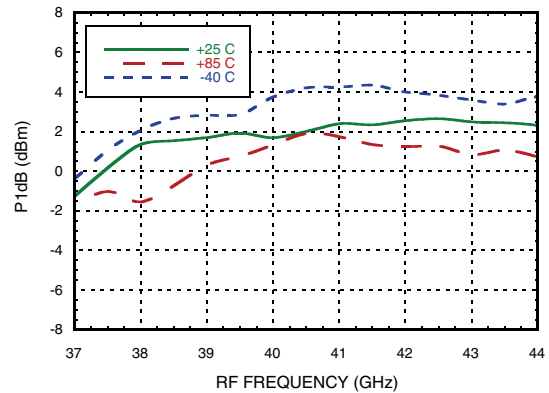

**Input IP3, USB vs. Temperature**

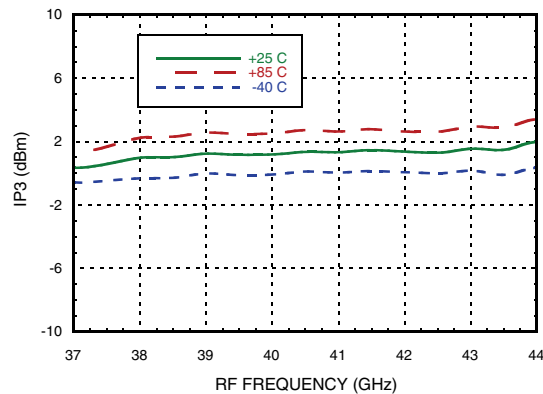

**Output IP3, USB vs. Temperature**

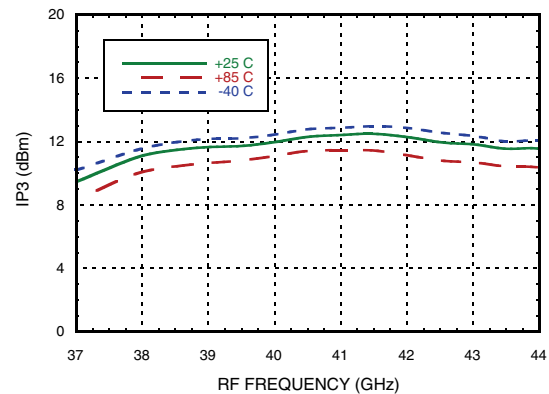



## GaAs MMIC I/Q DOWNCONVERTER 37 - 44 GHz

Data Taken as SSB Downconverter with External IF 90° Hybrid, IF = 1000 MHz

**Input IP3, USB vs. LO Power**

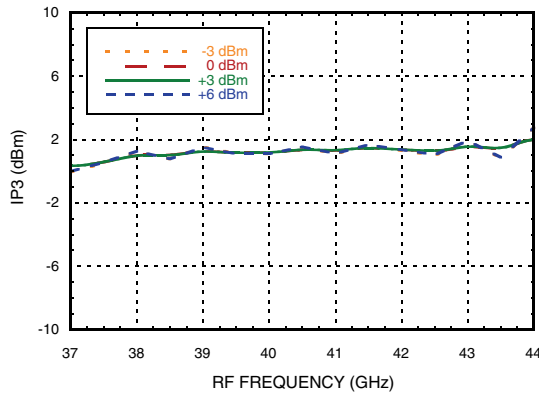

**Output IP3, USB vs. LO Power**

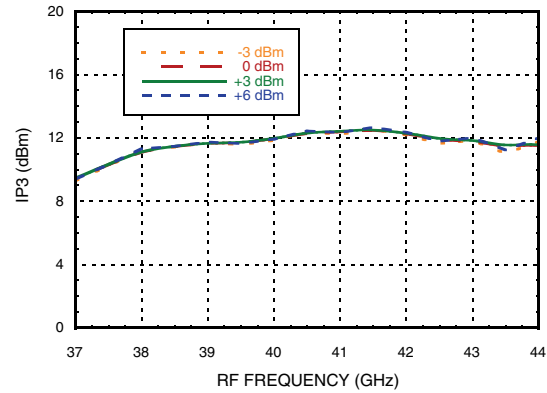

**IF Bandwidth [1]**

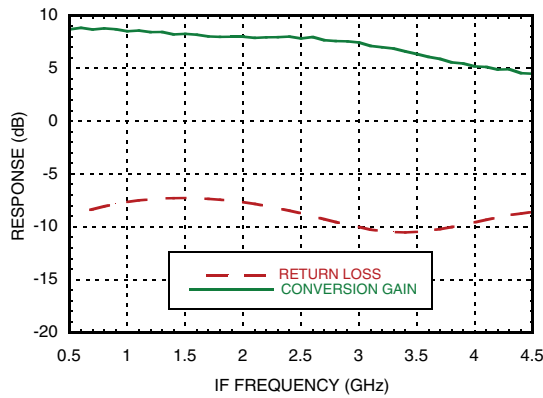

**Noise Figure vs. Temperature**

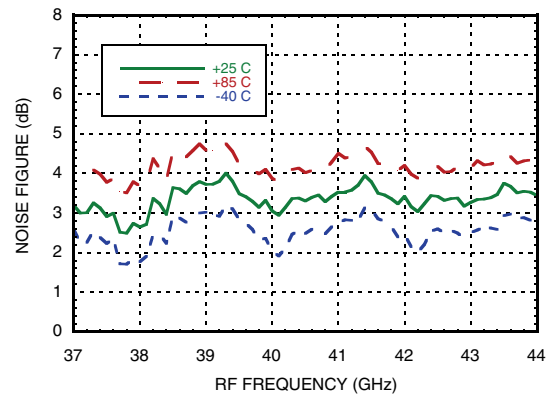

**Amplitude Balance vs. LO Drive**

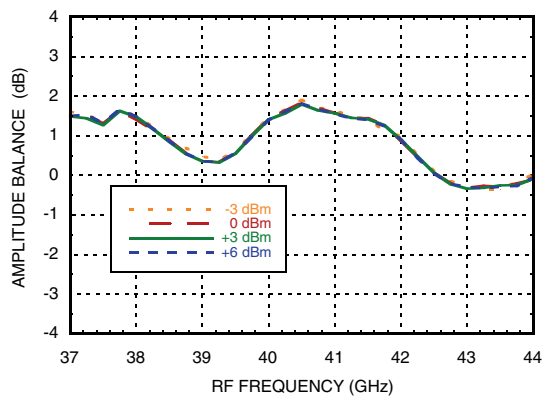

**Phase Balance vs. LO Drive**

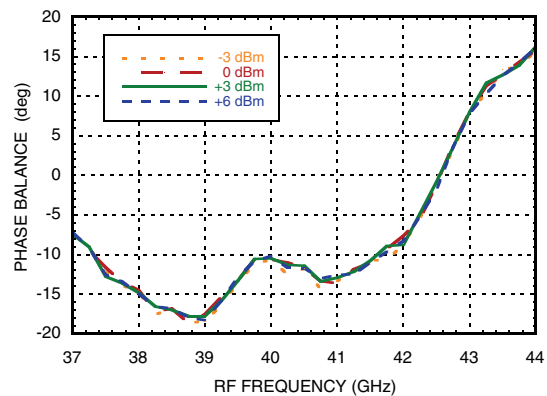

[1] LO = 18GHz



## GaAs MMIC I/Q DOWNCONVERTER 37 - 44 GHz

Data Taken as SSB Downconverter with External IF 90° Hybrid, IF = 2000 MHz

Conversion Gain, USB vs. Temperature

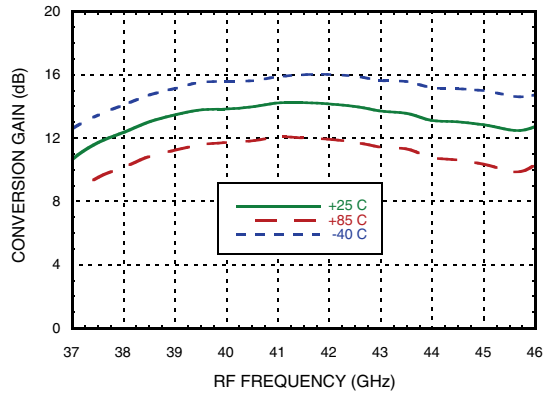

Conversion Gain, USB vs. LO Drive

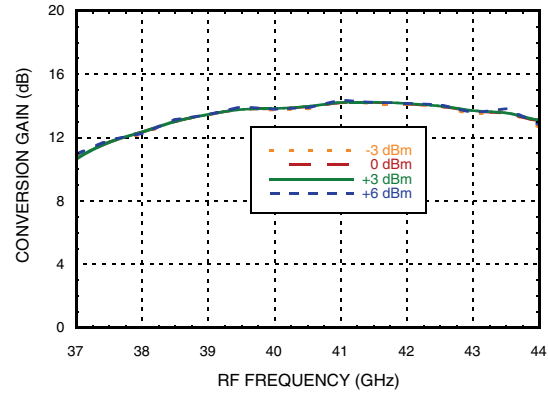
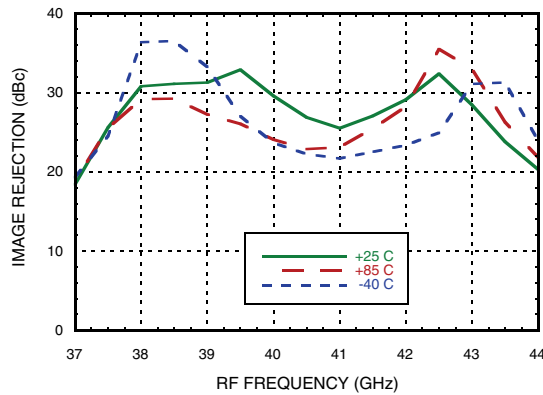
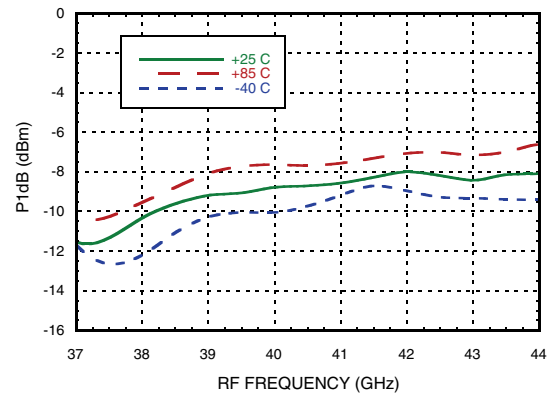

Image Rejection vs. Temperature



Input P1dB, USB vs. Temperature



Output P1dB, USB vs. Temperature

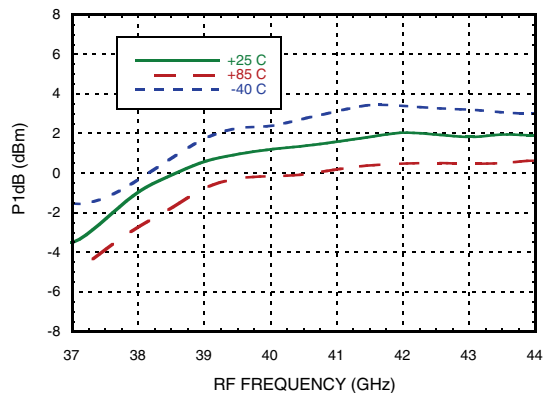

Input IP3, USB vs. Temperature

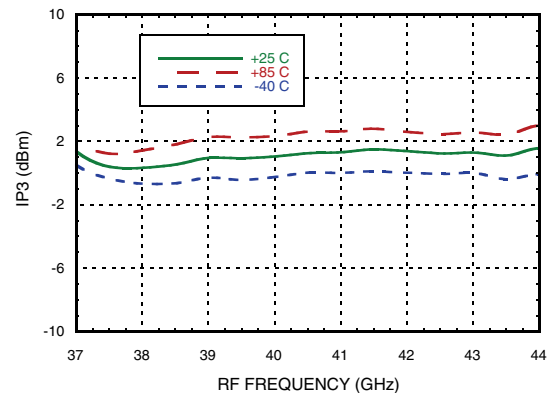



## GaAs MMIC I/Q DOWNCONVERTER 37 - 44 GHz

Data Taken as SSB Downconverter with External IF 90° Hybrid, IF = 2000 MHz

**Output IP3, USB vs. Temperature**

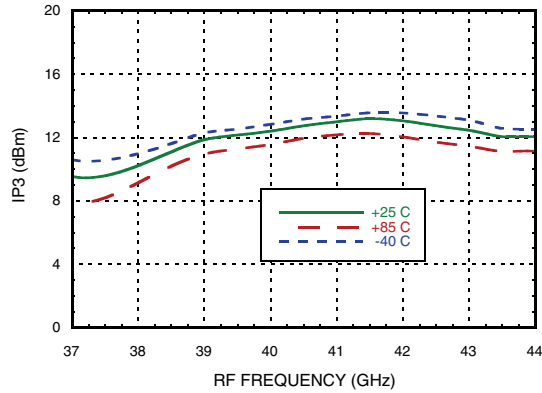

**Noise Figure vs. Temperature**

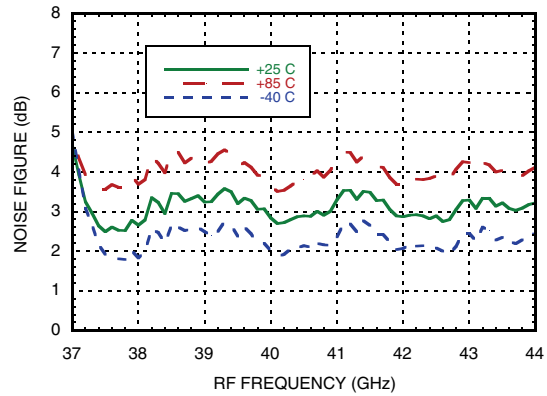

**MxN Spurious Outputs [1][2]**

mRF	nLO				
	0	1	2	3	4
0	xx	38	21		
1	17	48	0		
2	xx	xx	47		
3					
4					
5					

RF = 40 GHz @ -8 dBm  
LO = 19.5 GHz @ +4 dBm

**MxN Spurious Outputs [1][2]**

mRF	nLO				
	0	1	2	3	4
0	xx	42	16		
1	17	47	0		
2	xx	xx	43		
3					
4					
5					

RF = 40 GHz @ -8 dBm  
LO = 19.0 GHz @ +4 dBm

**MxN Spurious Outputs [1][2]**

mRF	nLO				
	0	1	2	3	4
0	xx	44	20		
1	17	41	0		
2	xx	xx	50		
3					
4					
5					

RF = 40 GHz @ -8 dBm  
LO = 18.5 GHz @ +4 dBm

[1] Data taken without external IF 90° hybrid  
[2] All values in dBc below RF power level (2LO + IF) USB





## GaAs MMIC I/Q DOWNCONVERTER 37 - 44 GHz

Data Taken as SSB Downconverter with External IF 90° Hybrid, IF = 3000 MHz

**Conversion Gain, USB vs. Temperature**

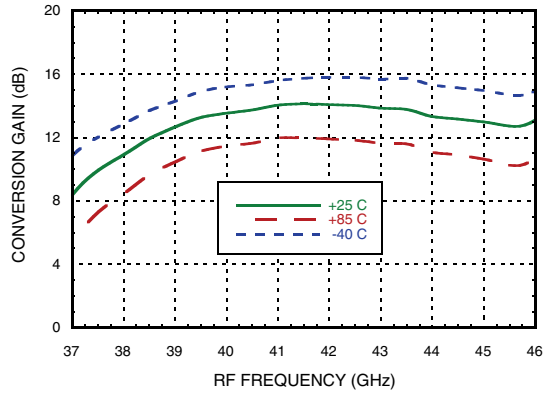

**Conversion Gain, USB vs. LO Drive**

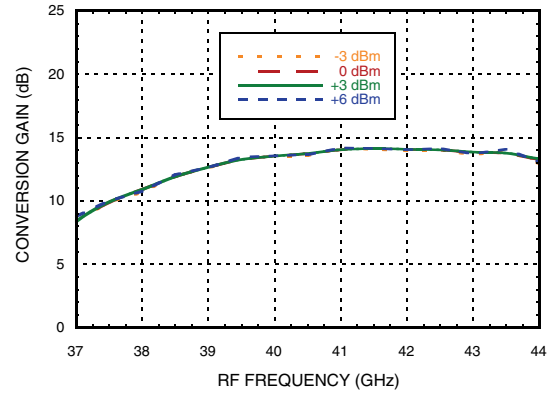

**Image Rejection vs. Temperature**

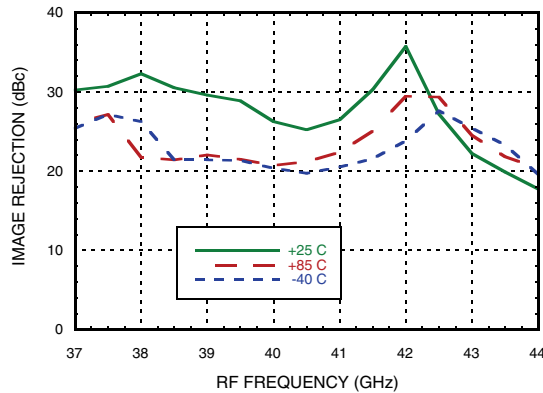

**Input P1dB, USB vs. Temperature**

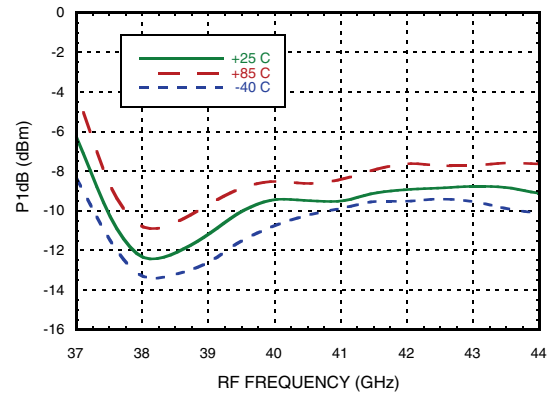

**Output P1dB, USB vs. Temperature**

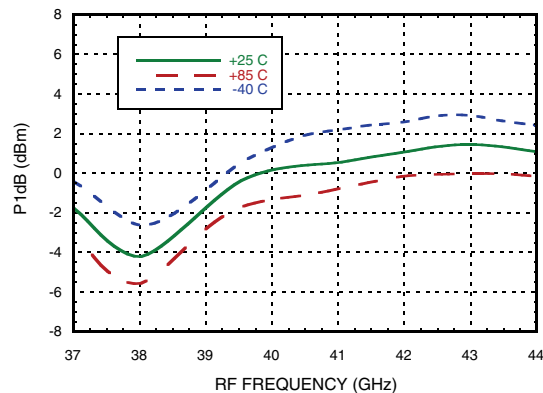

**Input IP3, USB vs. Temperature**

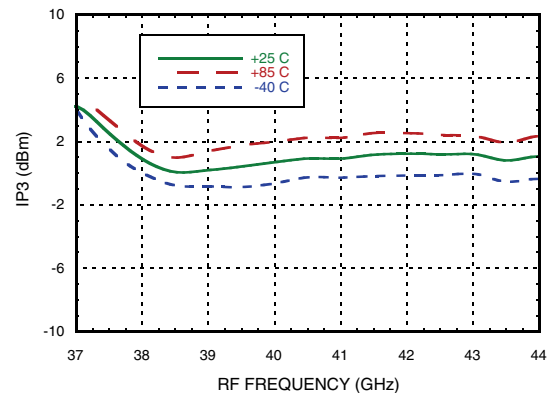

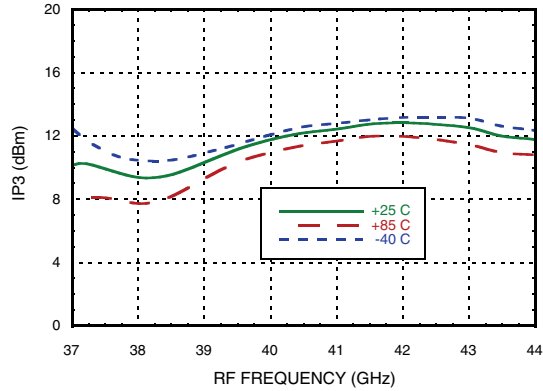
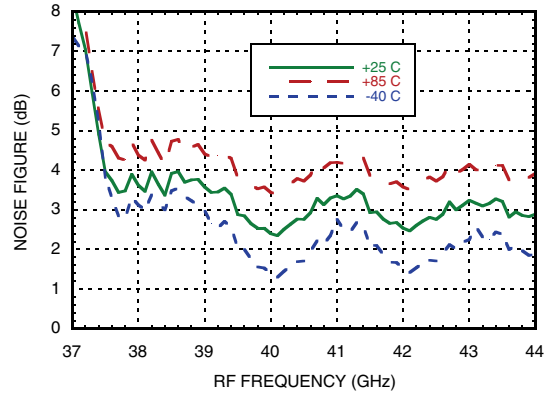

*Data Taken as SSB Downconverter with External IF 90° Hybrid, IF = 3000 MHz*

**Output IP3, USB vs. Temperature**

**Noise Figure vs. Temperature**

**Absolute Maximum Ratings**

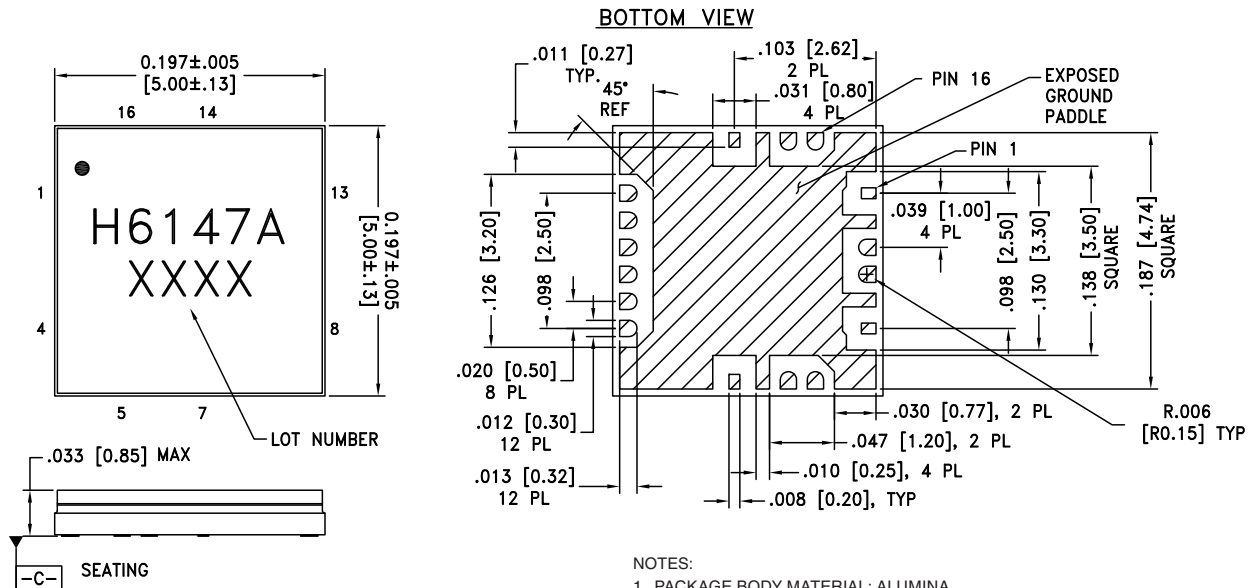
RF Input	+8 dBm
LO Input	+10 dBm
Bias Voltage, VDLO and VDRF	+3.5V
Channel Temperature	175 °C
Continuous Pdiss (T = 85°C) (derate 17.8 mW/°C above 85°C)	1.6 W
Thermal Resistance (channel to ground paddle)	56 °C/W
Storage Temperature	-65 to +150 °C
Operating Temperature	-40 to +85 °C
ESD Sensitivity (HBM)	Class1A

**ELECTROSTATIC SENSITIVE DEVICE  
OBSERVE HANDLING PRECAUTIONS**
**Outline Drawing**

**NOTES:**

1. PACKAGE BODY MATERIAL: ALUMINA
2. LEAD AND GROUND PADDLE PLATING: 30 - 80 MICROINCHES GOLD OVER 50 MICROINCHES MINIMUM NICKLE
3. DIMENSIONS ARE IN INCHES [MILLIMETERS]
4. LEAD SPACING TOLERANCE IS NON-CUMULATIVE
5. PACKAGE WARP SHALL NOT EXCEED 0.05mm DATUM
6. ALL GROUND LEADS AND GROUND PADDLE MUST BE SOLDERED TO PCB RF GROUND



**Package Information**

Part Number	Package Body Material	Lead Finish	MSL Rating	Package Marking <sup>[2]</sup>
HMC6147ALC5A	Alumina, White	Gold over Nickel	MSL3 <sup>[1]</sup>	6147A XXXX

[1] Max peak reflow temperature of 260 °C

[2] 4-Digit lot number XXXX

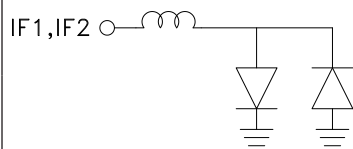
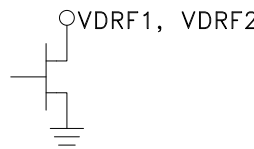
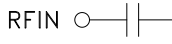
**Pin Descriptions**

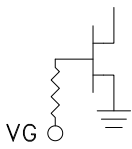
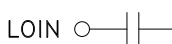
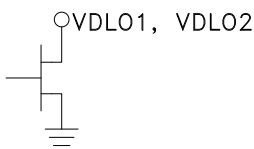
Pin Number	Function	Description	Interface Schematic
1, 4, 12,15	N/C	No connection required. The pins are not connected internally; however, all data shown herein was measured with these pins connected to RF/DC ground externally.	
2	IF1	These pins are DC coupled. For applications not requiring operation to DC this port should be DC blocked externally using a series capacitor whose value has been chosen to pass the necessary frequency range. For operation to DC, this pin must not sink / source more than 3 mA of current or part non-function and possible failure will result.	
3	IF2		
5	VDRF1	Bias for LNA. The recommended DC voltage is 3V	
6	VDRF2		
7	RFIN	This pin is AC coupled and matched to 50 Ohms.	
8,11, 16	GND	These pins and exposed ground paddle must be connected to RF/DC ground.	
9	VG	Adjust VGLO for -1V to 0V to set the multiplier quiescent current to 150mA	
10	LOIN	LO Input Port. The recommended LO Power is 0 to 6 dBm	
13	VDLO1	Bias for Multiplier input Buffer Amp. The recommended DC voltage is 3V	
14	VDLO2	Bias for Multiplier output Buffer Amp. The recommended DC voltage is 3V	

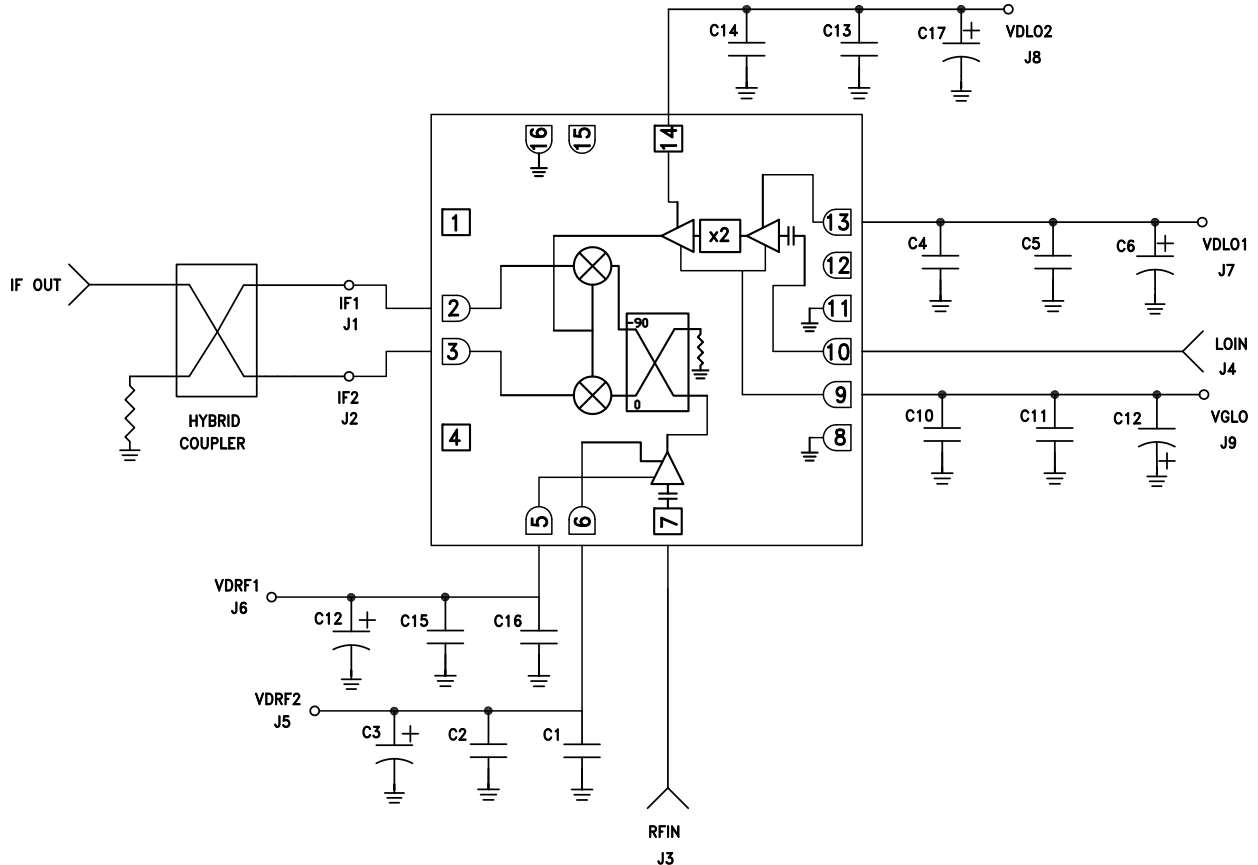
**Typical Application**

C1, C4, C10, C14, C16	100 pF Capacitor, 0402 Pkg.
C2, C5, C11, C13, C15	0.1uF Capacitor, 0402 Pkg.
C3, C6, C12, C17, C19	4.7 $\mu$ F Capacitor, Case A Pkg.

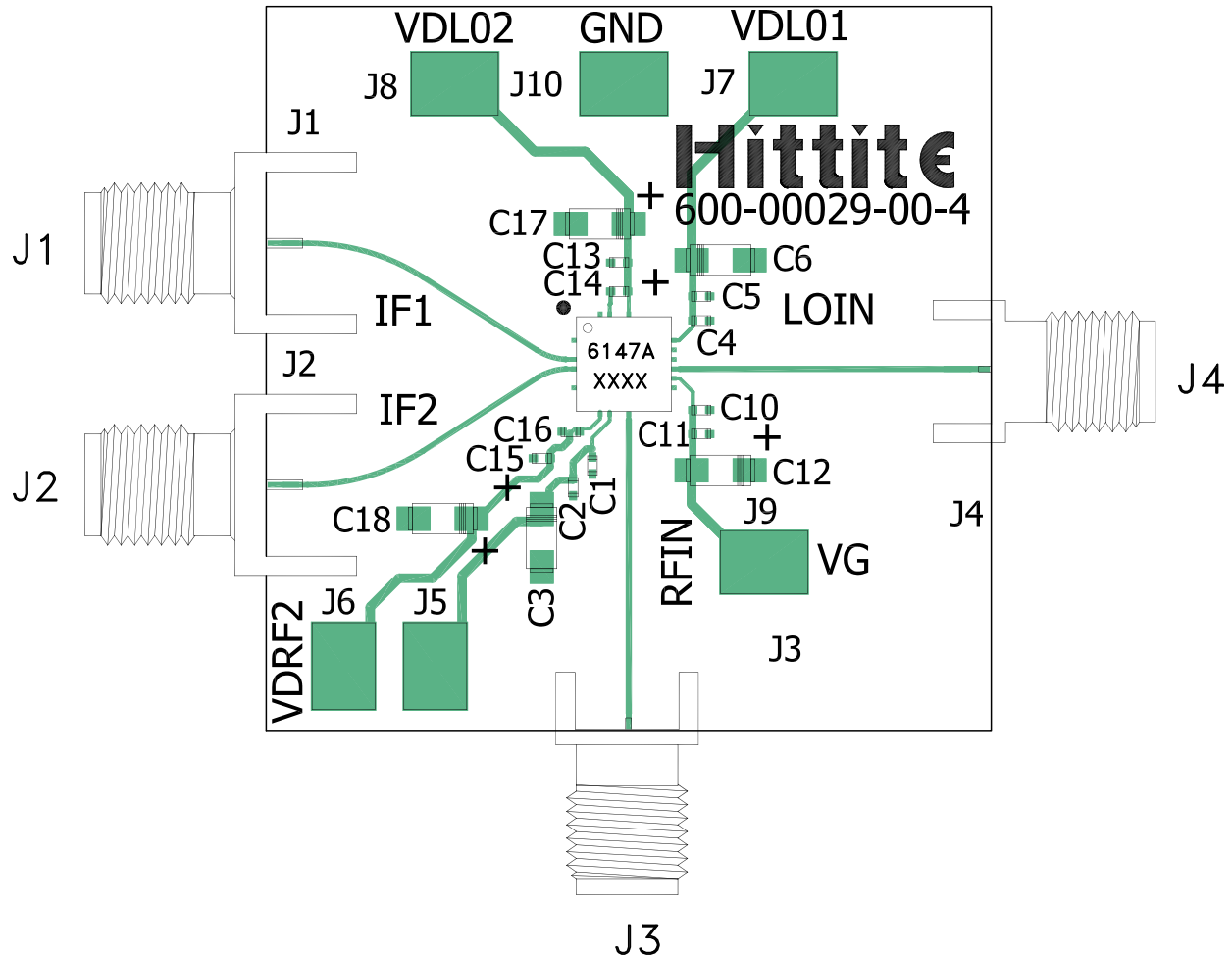
**Evaluation PCB**

**List of Materials for Evaluation PCB Eval01-HMC6147ALC5A <sup>[1]</sup>**

Item	Description
J1, J2	SMA Connector
J3, J4	K-Connector SRI
J5 - J10	DC Pins
C1, C4, C10, C14, C16	100 pF Capacitor, 0402 Pkg.
C2, C5, C11, C13, C15	0.1 uF Capacitor, 0402 Pkg.
C3, C6, C12, C17, C18	4.7 uF Capacitor, Case A
U1	HMC6147ALC5A Downconverter
PCB [2]	600-00029-00 Evaluation Board

[1] Reference this number when ordering complete evaluation PCB

[2] Circuit Board Material: Arlon 25FR, FR4 or Rogers 4350

The circuit board used in the application should use RF circuit design techniques. Signal lines should have 50 Ohm impedance while the package ground leads and exposed paddle should be connected directly to the ground plane similar to that shown. A sufficient number of via holes should be used to connect the top and bottom ground planes. The evaluation circuit board shown is available from Hittite upon request.



## Стандарт Электрон Связь

Мы молодая и активно развивающаяся компания в области поставок электронных компонентов. Мы поставляем электронные компоненты отечественного и импортного производства напрямую от производителей и с крупнейших складов мира.

Благодаря сотрудничеству с мировыми поставщиками мы осуществляем комплексные и плановые поставки широчайшего спектра электронных компонентов.

Собственная эффективная логистика и склад в обеспечивает надежную поставку продукции в точно указанные сроки по всей России.

Мы осуществляем техническую поддержку нашим клиентам и предпродажную проверку качества продукции. На все поставляемые продукты мы предоставляем гарантию .

Осуществляем поставки продукции под контролем ВП МО РФ на предприятия военно-промышленного комплекса России , а также работаем в рамках 275 ФЗ с открытием отдельных счетов в уполномоченном банке. Система менеджмента качества компании соответствует требованиям ГОСТ ISO 9001.

Минимальные сроки поставки, гибкие цены, неограниченный ассортимент и индивидуальный подход к клиентам являются основой для выстраивания долгосрочного и эффективного сотрудничества с предприятиями радиоэлектронной промышленности, предприятиями ВПК и научно-исследовательскими институтами России.

С нами вы становитесь еще успешнее!

### Наши контакты:

**Телефон:** +7 812 627 14 35

**Электронная почта:** [sales@st-electron.ru](mailto:sales@st-electron.ru)

**Адрес:** 198099, Санкт-Петербург,  
Промышленная ул, дом № 19, литера Н,  
помещение 100-Н Офис 331