

Analog Devices Welcomes Hittite Microwave Corporation

NO CONTENT ON THE ATTACHED DOCUMENT HAS CHANGED



THIS PAGE INTENTIONALLY LEFT BLANK

Typical Applications

The HMC646LP2(E) is ideal for:

- LNA Protection & T/R Switching
- TD-SCDMA / 3G Infrastructure
- Satellite Subscriber Terminals
- Private Mobile Radio & Public Safety Handsets
- Automotive Telematics

Features

- High Input P0.1dB: +46 dBm Tx
- Low Insertion Loss: 0.4 dB
- High IIP3: +74 dBm
- Single Positive Control: 0/+3V to 0/+8V
- Failsafe operation; Tx 'On' when unpowered
- 2x2mm DFN SMT Package

Functional Diagram

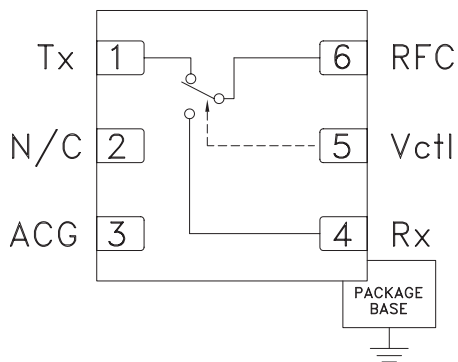

General Description

The HMC646LP2(E) is an SPDT switch in a leadless DFN surface mount plastic package for use in transmit / receive and LNA protection applications which require very low distortion and high power handling of up to 40 watts with less than 10% duty cycle. This robust switch can control signals from 100 - 2100 MHz* and is ideal for TD-SCDMA / 3G repeaters, PMR, automotive telematics, and satellite subscriber terminal applications. The design provides exceptional P0.1dB of +46 dBm and +74 dBm IIP3 on the Transmit (Tx) port. The failsafe topology provides a low loss path from Tx to RFC, when no DC power is available.

Electrical Specifications, $T_A = +25^\circ\text{C}$, $V_{dd} = 5\text{V}$, $V_{ctl} = 0/+5\text{Vdc}$, 50 Ohm System*

Parameter	Min.	Typ.	Max.	Min.	Typ.	Max.	Min.	Typ.	Max.	Units
Frequency Range	869 - 960			1525 - 1661			2010 - 2025			MHz
Insertion Loss	Tx - RFC	0.3	0.6		0.6	0.9		0.7	1.0	dB
	RFC - Rx	0.4	0.7		0.8	1.1		1.3	1.7	dB
Isolation	Tx - RFC	20	27		15	22		12	17	dB
	RFC - Rx	28	38		20	30		25	32	dB
Return Loss	Tx - RFC		17			27			25	dB
	RFC - Rx		25			20			12	dB
Input Power for 0.1 dB Compression	Tx - RFC		44			46			46	dBm
	RFC - Rx		20			20			20	dBm
Input Third Order Intercept (Two-tone input power = +17 dBm each tone)	Tx - RFC		71			74			74	dBm
	RFC - Rx		41			42			34	dBm
Switching Characteristics	tRISE, tFALL (10/90% RF)		100			100			100	ns
	tON, (50% CTL to 90% RF)		320			320			320	ns
	tOFF (50% CTL to 10% RF)		320			320			320	ns

* Specifications and data reflect HMC646LP2(E) measured using the respective application circuits for each designated frequency band found herein



Insertion Loss vs. Temperature, Tx with 915 MHz Tuning

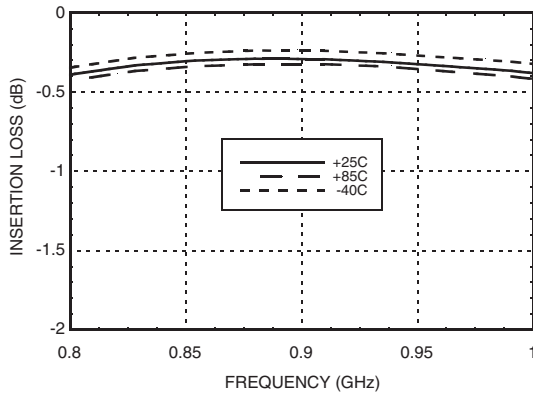

Insertion Loss vs. Temperature, Rx with 915 MHz Tuning

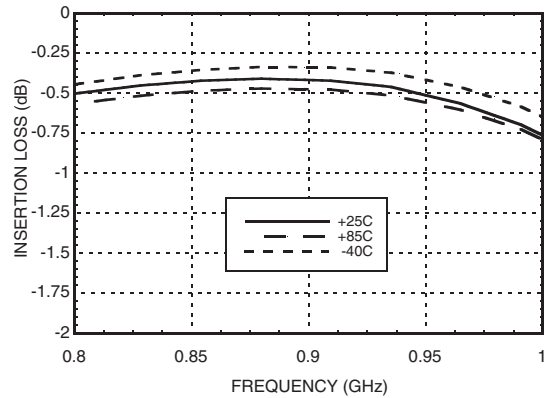

Isolation with 915 MHz Tuning

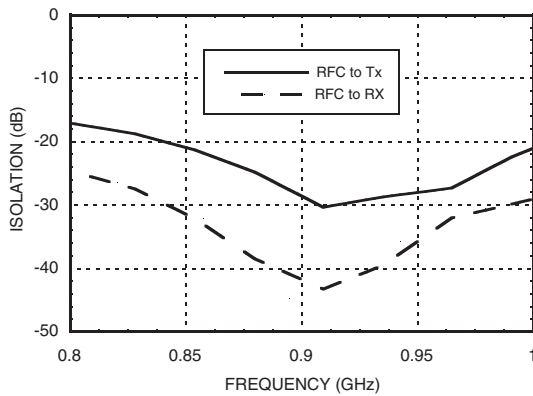

Return Loss with 915 MHz Tuning

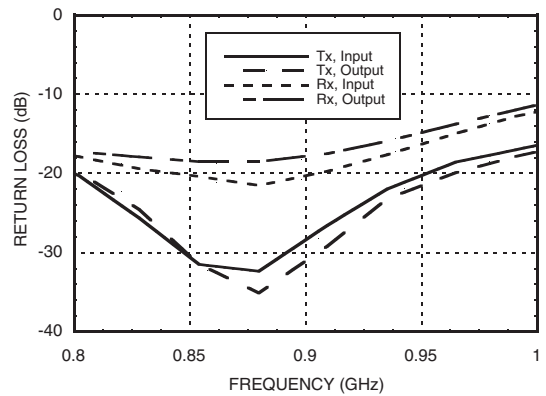

Input IP3 vs. Voltage with 915 MHz Tuning

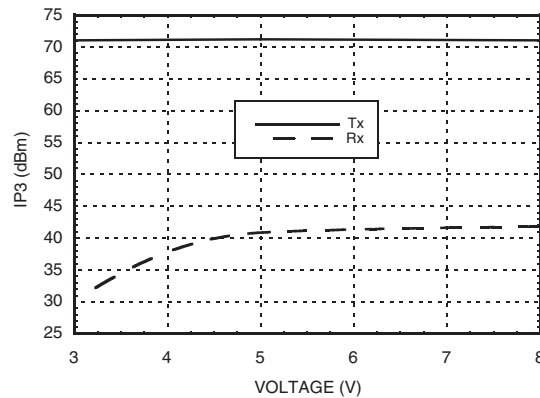



GaAs MMIC 40W FAILSAFE SWITCH, 0.1 - 2.1 GHz

Insertion Loss vs. Temperature, Tx with 1600 MHz Tuning

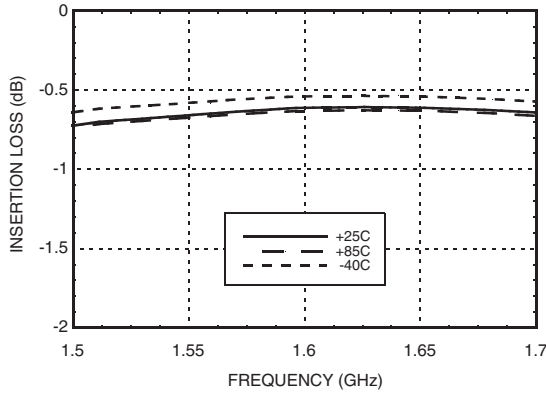

Insertion Loss vs. Temperature, Rx with 1600 MHz Tuning

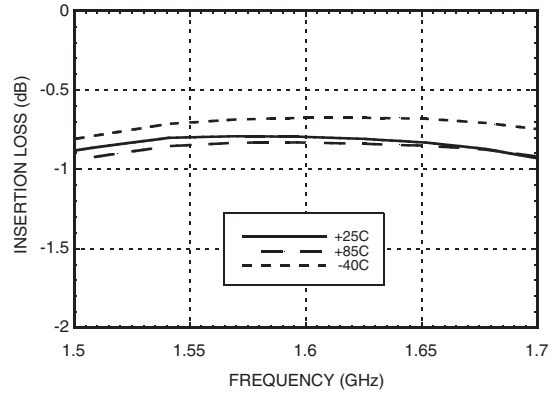

Isolation with 1600 MHz Tuning

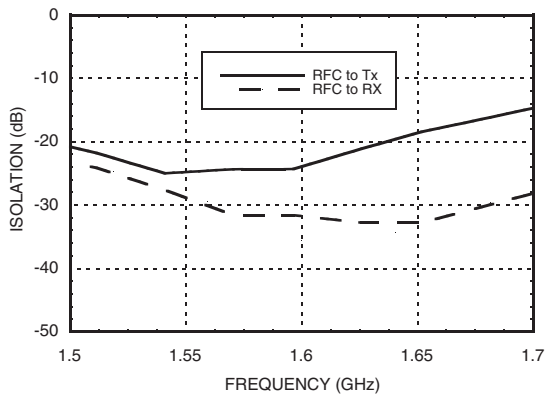

Return Loss with 1600 MHz Tuning

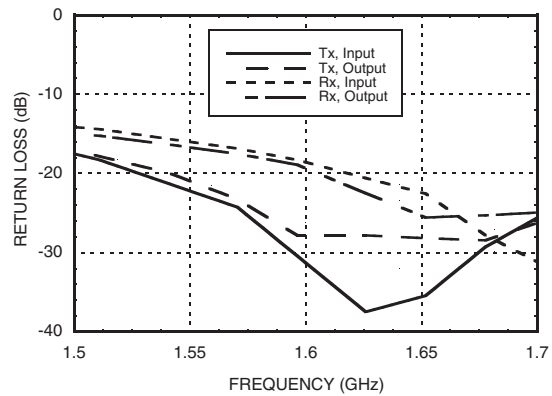

Input IP3 vs. Voltage with 1600 MHz Tuning

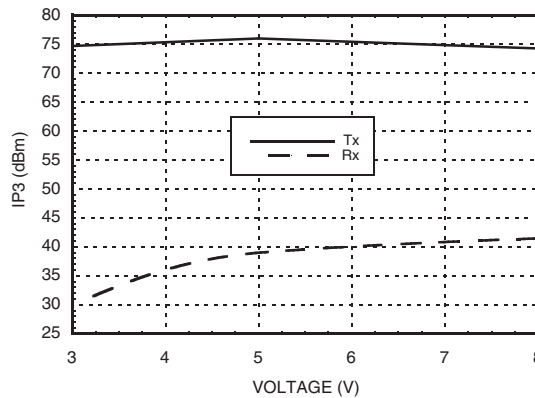



Insertion Loss vs. Temperature, Tx with 2015 MHz Tuning

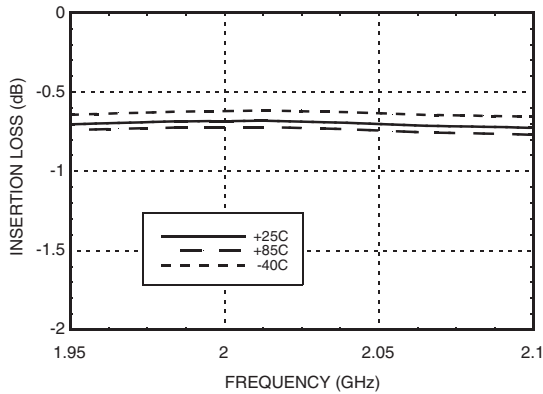

Insertion Loss vs. Temperature, Rx with 2015 MHz Tuning

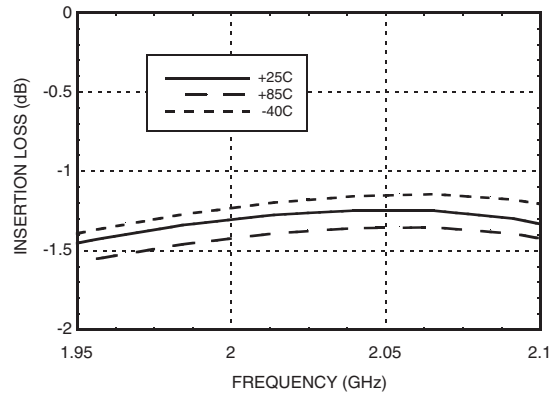

Isolation with 2015 MHz Tuning

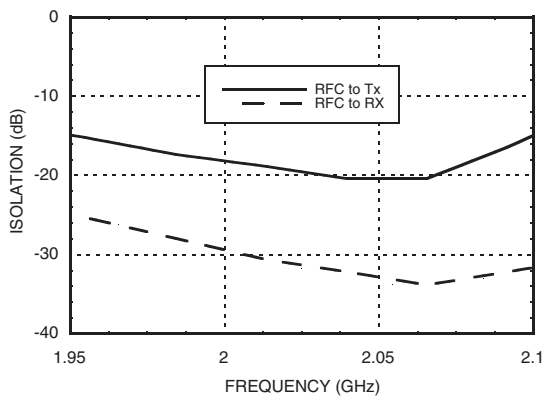

Return Loss with 2015 MHz Tuning

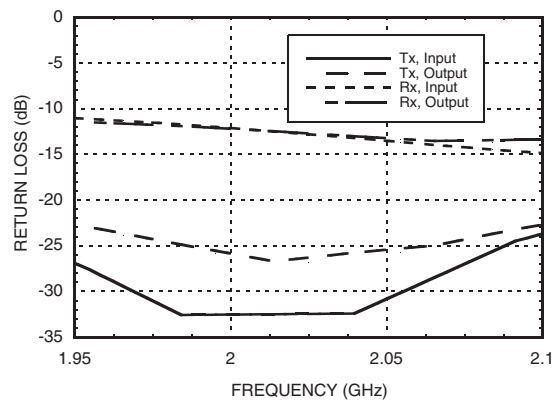

Input IP3 vs. Voltage with 2015 MHz Tuning

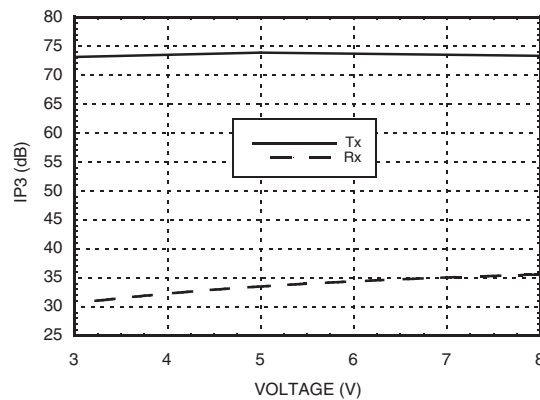

Absolute Maximum Ratings

		Vdd = 5V
Max. CW Input Power	Tx Port	+44.00 dBm
	Rx Port	+36.75 dBm
Max Channel Temp.		150 °C
Thermal Resistance	Tx Port	14.75 °C/W
	Rx Port	14.75 °C/W
Continuous Dissipated Power	Tx Port	4.4 W
	Rx Port	4.4 W
Supply Voltage (Vdd)		+10V Vdc
Control Voltage Range (Vctl)		-0.2 to Vdd + 1.0 Vdc
Storage Temperature		-65 to +150 °C
Operating Temperature		-40 to +85 °C

Truth Table

Control Input		Signal Path State	
Vctl	Vdd	RFC To Tx	RFC to Rx
0.0	0.0	ON	OFF
0.0	Vdd	OFF	ON
Vdd	Vdd	ON	OFF

Vdd = +3V to +8V
Control Input Voltage Tolerances are ± 0.2 Vdc.

DC blocking capacitors are required at ports RFC, Tx and Rx.



**ELECTROSTATIC SENSITIVE DEVICE
OBSERVE HANDLING PRECAUTIONS**

Outline Drawing

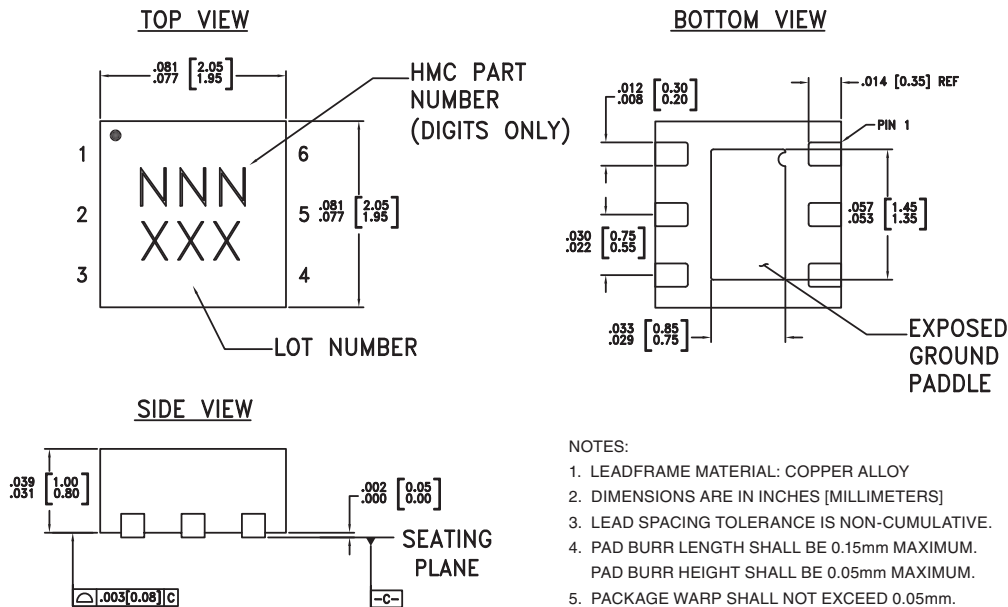

NOTES:

- LEADFRAME MATERIAL: COPPER ALLOY
- DIMENSIONS ARE IN INCHES [MILLIMETERS]
- LEAD SPACING TOLERANCE IS NON-CUMULATIVE.
- PAD BURR LENGTH SHALL BE 0.15mm MAXIMUM. PAD BURR HEIGHT SHALL BE 0.05mm MAXIMUM.
- PACKAGE WARP SHALL NOT EXCEED 0.05mm.
- ALL GROUND LEADS AND GROUND PADDLE MUST BE SOLDERED TO PCB RF GROUND.
- REFER TO HITTITE APPLICATION NOTE FOR SUGGESTED LAND PATTERN.

Package Information

Part Number	Package Body Material	Lead Finish	MSL Rating	Package Marking ^[3]
HMC646LP2	Low Stress Injection Molded Plastic	Sn/Pb Solder	MSL1 ^[1]	646 XXX
HMC646LP2E	RoHS-compliant Low Stress Injection Molded Plastic	100% matte Sn	MSL1 ^[2]	646 XXX

[1] Max peak reflow temperature of 235 °C



[2] Max peak reflow temperature of 260 °C

[3] 3-Digit lot number XXX

For price, delivery, and to place orders, please contact Hittite Microwave Corporation:
20 Alpha Road, Chelmsford, MA 01824 Phone: 978-250-3343 Fax: 978-250-3373
Order On-line at www.hittite.com

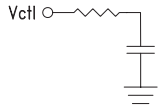

Pin Descriptions

Pin Number	Function	Description	Interface Schematic
1	Tx	This pin is DC coupled and matched to 50 Ohms.	
2	N/C	Not Connected	
3	ACG	External capacitor to ground is required. See application circuit herein.	
4	Rx	This pin is DC coupled and matched to 50 Ohms.	
5	Vctl	See truth table.	
6	RFC	This pin is DC coupled and matched to 50 Ohms.	
	GND	Package bottom has exposed metal paddle that must be connected to PCB RF ground.	

Application Circuit

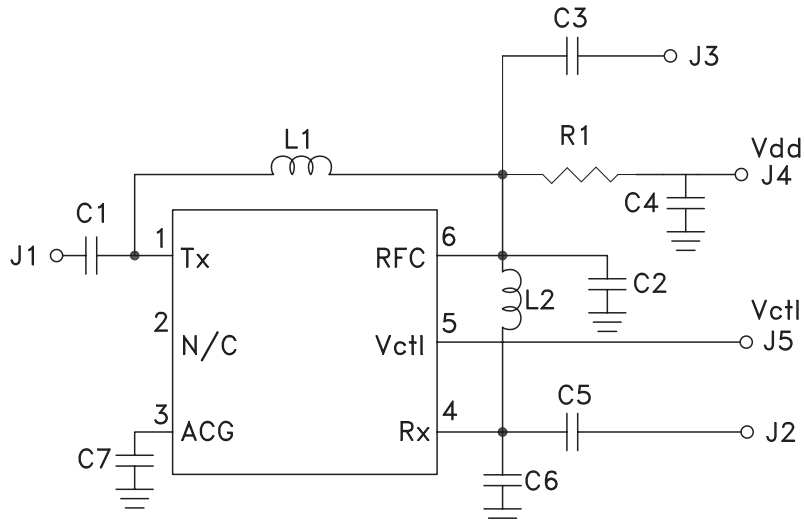

Components for Selected Frequencies

Tuned Frequency	915 MHz	1600 MHz	2015 MHz
Evaluation PCB Number	118098	118099	118100
C1, C3, C5 ^[1]	1000 pF	330 pF	330 pF
C2	2.7 pF	1.5 pF	1.1 pF
C4	1000 pF	100 pF	100 pF
C6	1.8 pF	0.5 pF	0.5 pF
C7	15 pF	4.7 pF	2.7 pF
L1	15 nH	3.9 nH	1.8 nH
L2	9 nH	4.3 nH	3.3 nH
R1	10 k	10 k	10 k

[1] DC blocking capacitors

Evaluation PCB

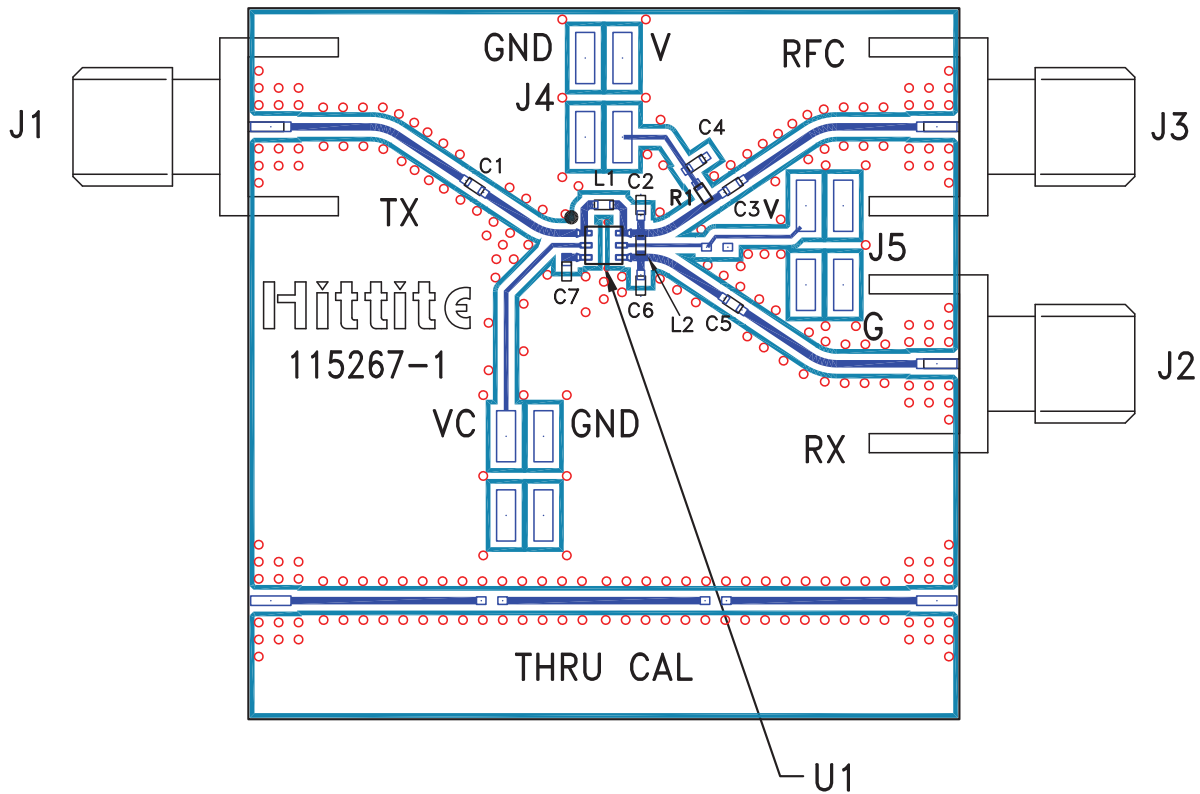

List of Materials for Evaluation PCB [1]

Item	Description
J1 - J3	PCB Mount SMA RF Connector
J4 - J5	2mm DC Header
C1 - C7 [2]	Capacitor, 0402 Pkg.
L1 - L2 [2]	Inductor, 0402 Pkg.
R1 [2]	Resistor, 0402 Pkg.
U1	HMC646LP2(E) T/R Switch
PCB [3]	110780 Evaluation PCB

[1] When requesting an evaluation board, please reference the appropriate evaluation PCB number listed in the table "Components for Selected Frequencies."

[2] Please refer to "Components for Selected Frequencies" table for values.

[3] Circuit Board Material: Rogers 4350

The circuit board used in the final application should be generated with proper RF circuit design techniques. Signal lines at the RF port should have 50 ohm impedance and the package ground leads and exposed paddle should be connected directly to the ground plane similar to that shown above. The evaluation circuit board shown above is available from Hittite Microwave Corporation upon request.



Стандарт Электрон Связь

Мы молодая и активно развивающаяся компания в области поставок электронных компонентов. Мы поставляем электронные компоненты отечественного и импортного производства напрямую от производителей и с крупнейших складов мира.

Благодаря сотрудничеству с мировыми поставщиками мы осуществляем комплексные и плановые поставки широчайшего спектра электронных компонентов.

Собственная эффективная логистика и склад в обеспечивает надежную поставку продукции в точно указанные сроки по всей России.

Мы осуществляем техническую поддержку нашим клиентам и предпродажную проверку качества продукции. На все поставляемые продукты мы предоставляем гарантию .

Осуществляем поставки продукции под контролем ВП МО РФ на предприятия военно-промышленного комплекса России , а также работаем в рамках 275 ФЗ с открытием отдельных счетов в уполномоченном банке. Система менеджмента качества компании соответствует требованиям ГОСТ ISO 9001.

Минимальные сроки поставки, гибкие цены, неограниченный ассортимент и индивидуальный подход к клиентам являются основой для выстраивания долгосрочного и эффективного сотрудничества с предприятиями радиоэлектронной промышленности, предприятиями ВПК и научно-исследовательскими институтами России.

С нами вы становитесь еще успешнее!

Наши контакты:

Телефон: +7 812 627 14 35

Электронная почта: sales@st-electron.ru

Адрес: 198099, Санкт-Петербург,
Промышленная ул, дом № 19, литера Н,
помещение 100-Н Офис 331