

DATA SHEET

# SKY12236-11: High IIP3, 2.6 to 5.0 GHz Voltage-Controlled Variable Attenuator

## Applications

- Automatic power leveling/gain control circuits in cellular base stations and point-to-point radio IF chains
- General wireless systems including WiMAX, LTE, WCDMA, VSAT, and military communications

## Features

- Broadband operating range: 2.6 to 5.0 GHz
- Maximum attenuation: 25 dB
- Control voltage range: 0 to 5 V
- High IIP3: +43 dBm
- Low current consumption: <2 mA @ maximum attenuation
- Small, MCM (8-pin, 4.9 x 3.2 mm) package (MSL3, 260 °C per JEDEC J-STD-020)



Skyworks Green™ products are compliant with all applicable legislation and are halogen-free. For additional information, refer to *Skyworks Definition of Green™*, document number SQ04-0074.

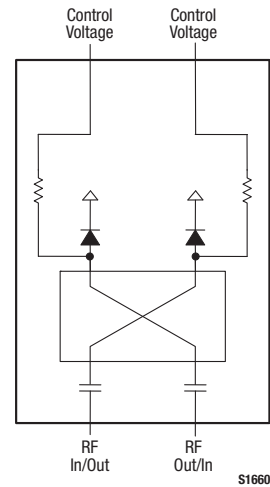

Figure 1. SKY12236-11 Block Diagram

## Description

The SKY12236-11 is a voltage-controlled variable attenuator from Skyworks series of high 3<sup>rd</sup> Order Input Intercept Point (IIP3) components. The device has been designed to operate over the 2.6 to 5.0 GHz frequency band, but is specifically optimized for use as a wide dynamic range, low distortion attenuator.

The SKY12236-11 provides monotonic attenuation performance over its entire control voltage range. This attenuator is comprised of a pair of matched PIN diodes that terminate two ports of its internal 90-degree hybrid coupler. The diodes are biased using an external control voltage signal. The attenuator requires no external components. It operates with a control voltage range of 0 to 5 V and a 1.7 mA typical control current at maximum attenuation.

A functional block diagram is shown in Figure 1. The pin configuration and package are shown in Figure 2. Signal pin assignments and functional pin descriptions are provided in Table 1.

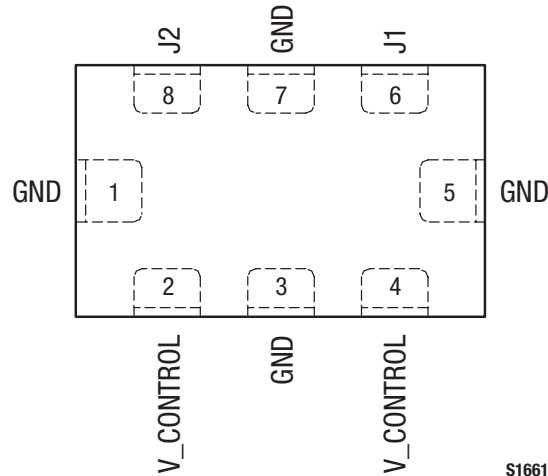

S1661

**Figure 2. SKY12236-11 Pinout – 8-Pin MCM (Top View)**

**Table 1. SKY12236-11 Signal Descriptions**

Pin	Name	Description	Pin	Name	Description
1	GND	Ground. Must be connected to PCB ground using lowest possible inductance path.	5	GND	Ground. Must be connected to PCB ground using lowest possible inductance path.
2	V_CONTROL	Control voltage input (voltage applied is nominally equal to the voltage applied to pin 4)	6	J1	RF input/output
3	GND	Ground. Must be connected to PCB ground using lowest possible inductance path.	7	GND	Ground. Must be connected to PCB ground using lowest possible inductance path.
4	V_CONTROL	Control voltage input (voltage applied is nominally equal to the voltage applied to pin 2)	8	J2	RF output/input

### Technical Description

The SKY12236-11 is a 50 Ω matched voltage-controlled variable attenuator with monotonic attenuation performance from 2.6 to 5.0 GHz over its entire control voltage range. This attenuator requires no external biasing or RF matching components.

Monotonic performance means the attenuation increases as the applied DC voltage increases. This attenuator is comprised of a pair of matched PIN diodes that terminate two ports of an internal 90-degree hybrid coupler.

The diodes are biased using an external control voltage signal that sets the bias current through a resistive network. The attenuator operates with a control voltage range of 0 to 5 V and a 1.7 mA typical control current at maximum attenuation. As the control voltage increases, the bias current through each of the PIN diodes

also increases. This increased bias current lowers the resistance of the PIN diodes. Maximum attenuation occurs when the resistance of the PIN diodes equals the characteristic impedance of the hybrid coupler ports, which they terminate. This occurs at a control voltage of approximately 5 VDC.

### Electrical and Mechanical Specifications

The absolute maximum ratings of the SKY12236-11 are provided in Table 2. Electrical specifications are provided in Table 3.

Performance characteristics for the SKY12236-11 are illustrated in Figures 3 through 8.

**Table 2. SKY12236-11 Absolute Maximum Ratings**

Parameter	Symbol	Minimum	Maximum	Units
Control voltage	V <sub>DC</sub>		10	V
RF input power (CW)	P <sub>IN</sub>		4	W
Control current	I <sub>CC</sub>		50	mA
Diode reverse bias voltage			50	V
Storage temperature	T <sub>STG</sub>	-40	+85	°C
Operating temperature	T <sub>OP</sub>	-40	+85	°C
Electrostatic discharge:	ESD			
Charged-Device Model (CDM), Class 3			500	V
Human Body Model (HBM), Class 1A			250	V
Machine Model (MM), Class A			50	V

**Note:** Exposure to maximum rating conditions for extended periods may reduce device reliability. There is no damage to device with only one parameter set at the limit and all other parameters set at or below their nominal value. Exceeding any of the limits listed here may result in permanent damage to the device.

**CAUTION:** Although this device is designed to be as robust as possible, Electrostatic Discharge (ESD) can damage this device. This device must be protected at all times from ESD. Static charges may easily produce potentials of several kilovolts on the human body or equipment, which can discharge without detection. Industry-standard ESD precautions should be used at all times.

**Table 3. SKY12236-11 Electrical Specifications (Note 1)**

(T<sub>OP</sub> = +25 °C, V<sub>CONTROL</sub> = 0 to 5 V, P<sub>IN</sub> = 0 dBm, Characteristic Impedance [Z<sub>0</sub>] = 50 Ω, Unless Otherwise Noted)

Parameter	Symbol	Test Condition	Min	Typical	Max	Units
Attenuation	Attn	f = 3.5 GHz, V <sub>CONTROL</sub> = 5 V	22	25		dB
Control current	I <sub>CC</sub>	V <sub>CONTROL</sub> = 5 V		1.7		mA
Insertion loss	IL	V <sub>CONTROL</sub> = 0 V, f = 2.6 to 5.0 GHz		2.5		dB
		V <sub>CONTROL</sub> = 0 V, f = 3.5 GHz		1.7	2.1	dB
Return loss	RL	V <sub>CONTROL</sub> = 0 V, f = 2.6 to 5.0 GHz		20		dB
3 <sup>rd</sup> Order Input Intercept Point	IIP3	P <sub>IN</sub> = +8 dBm each tone, V <sub>CONTROL</sub> = 0 V, f1 = 3.50 GHz, f2 = 3.51 GHz		+43		dBm

**Note 1:** Performance is guaranteed only under the conditions listed in this table.

### Typical Performance Characteristics

( $T_{OP} = +25\text{ }^{\circ}\text{C}$ ,  $V_{CONTROL} = 0\text{ to }5\text{ V}$ ,  $P_{IN} = 0\text{ dBm}$ , Characteristic Impedance [ $Z_0$ ] =  $50\text{ }\Omega$ , J1 = Input Port, J2 = Output Port, Unless Otherwise Noted)

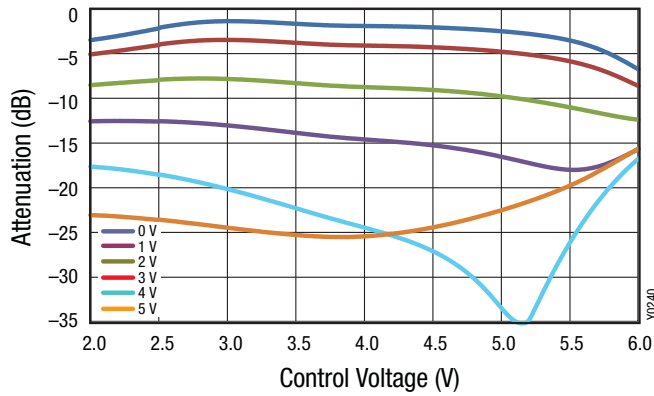

Figure 3. Attenuation vs Frequency Over Control Voltage

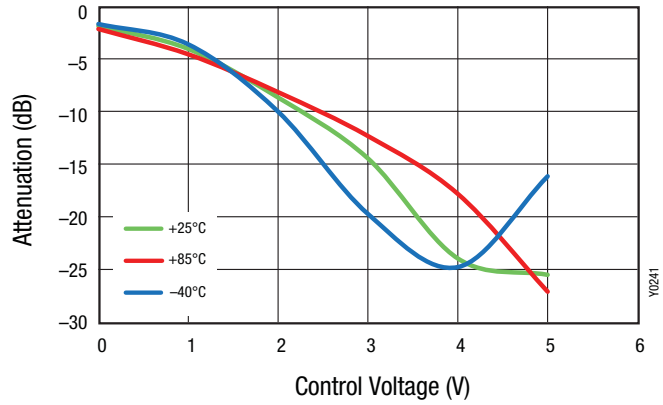

Figure 4. Attenuation vs Control Voltage Over Temperature (f = 3.8 GHz)

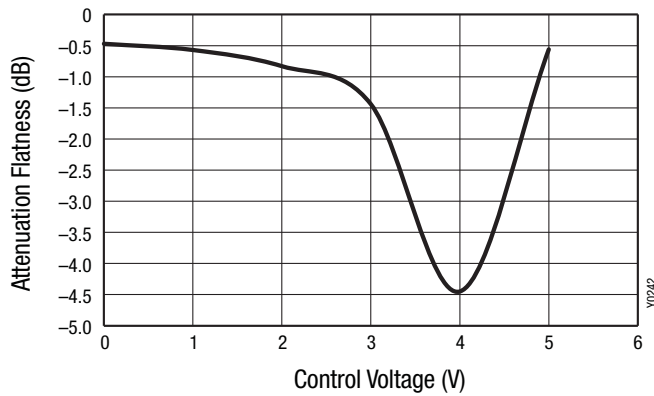

Figure 5. Attenuation Flatness vs Control Voltage (f = 3.3 to 4.3 GHz)

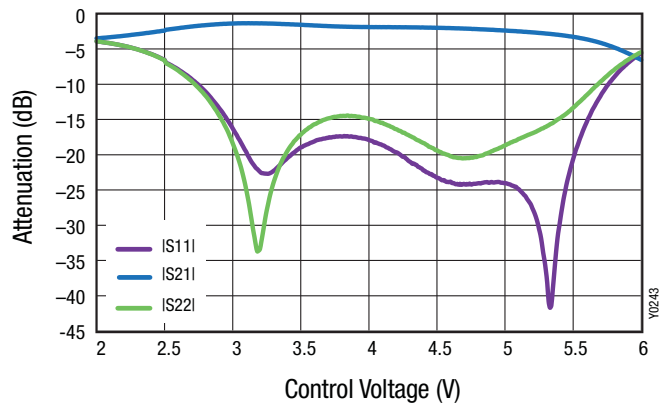

Figure 6. S-Parameters vs Frequency

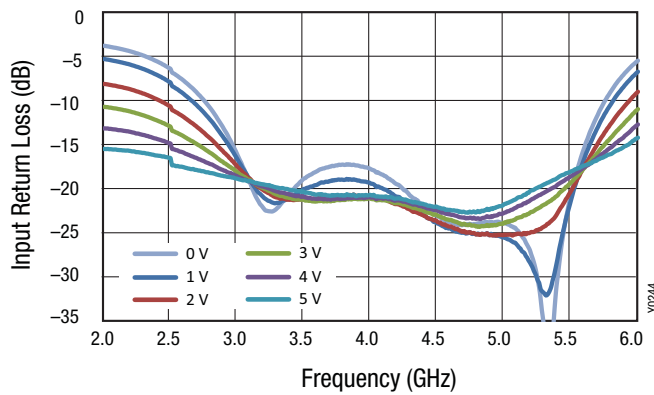

Figure 7. Input Return Loss vs Frequency Over Control Voltage

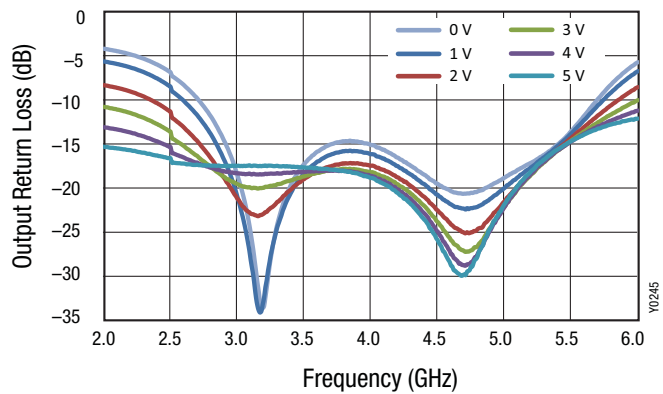

Figure 8. Output Return Loss vs Frequency Over Control Voltage

### Evaluation Board Description

The SKY12236-11 Evaluation Board is used to test the performance of the SKY12236-11 variable attenuator. An assembly drawing for the Evaluation Board is shown in Figure 9. The Evaluation Board layer detail is shown in Figure 10.

The attenuation level of the SKY12236-11 is controlled by applying 0 to 5 V to the V\_CONTROL pins.

### Package Dimensions

The PCB layout footprint for the SKY12236-11 is shown in Figure 11. Typical case markings are shown in Figure 12. Package dimensions for the 8-pin MCM are shown in Figure 13, and tape and reel dimensions are provided in Figure 14.

### Package and Handling Information

Since the device is sensitive to moisture absorption, it is baked and vacuum packed before shipping. Instructions on the shipping container label regarding exposure to moisture after the container seal is broken must be followed. Otherwise, problems related to moisture absorption may occur when the part is subjected to high temperature during solder assembly.

The SKY12236-11 is rated to Moisture Sensitivity Level 3 (MSL3) at 260 °C. It can be used for lead or lead-free soldering. For additional information, refer to the Skyworks Application Note, *PCB Design & SMT Assembly/Rework Guidelines for MCM-L Packages*, document number 101752.

Care must be taken when attaching this product, whether it is done manually or in a production solder reflow environment. Production quantities of this product are shipped in a standard tape and reel format.

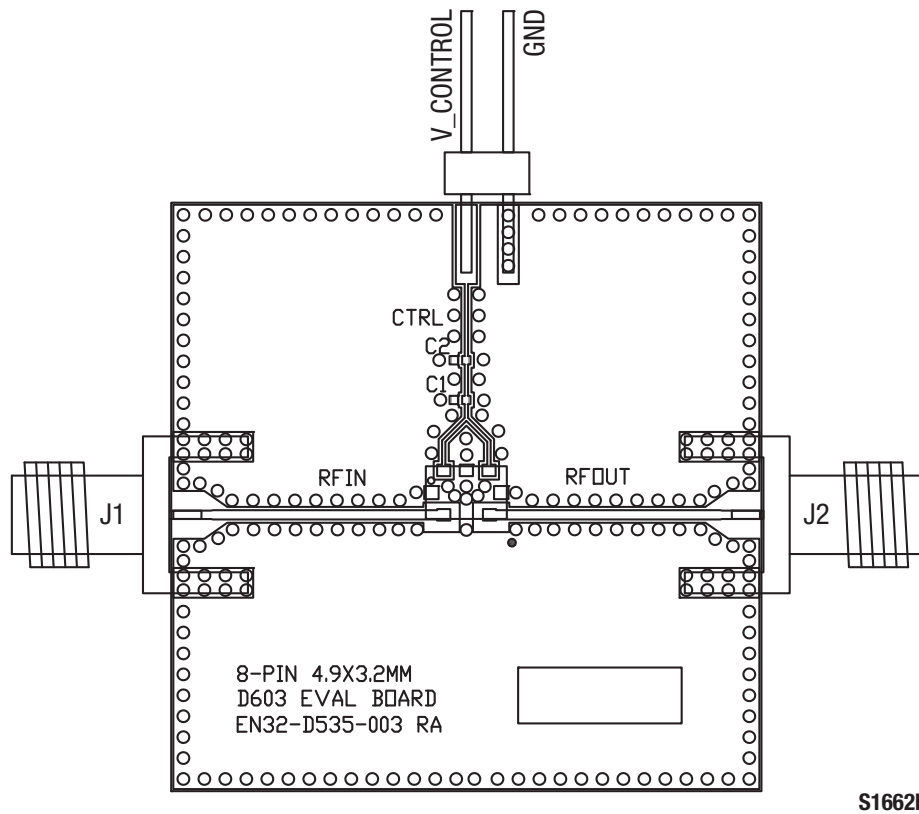

Figure 9. SKY12236-11 Evaluation Board Assembly Diagram

Cross Section	Name	Thickness (in)	Material
	Top Soldermask		
	L1	(0.0028)	Cu foil
	Laminate	0.012 ± 0.0006	Rogers R04003C Core
	L2	(0.0014)	Cu foil
	Laminate	(Note 1)	FR4 Prepreg
	L3	(0.0014)	Cu foil
	Laminate	0.010 ± 0.0006	FR4 Core
	L4	(0.0028)	Cu foil
	Bottom Soldermask		

*Note 1: Adjust this thickness to meet total thickness goal of 0.062 ± 0.005 inches.*

S2531

**Figure 10. Layer Detail Physical Characteristics**

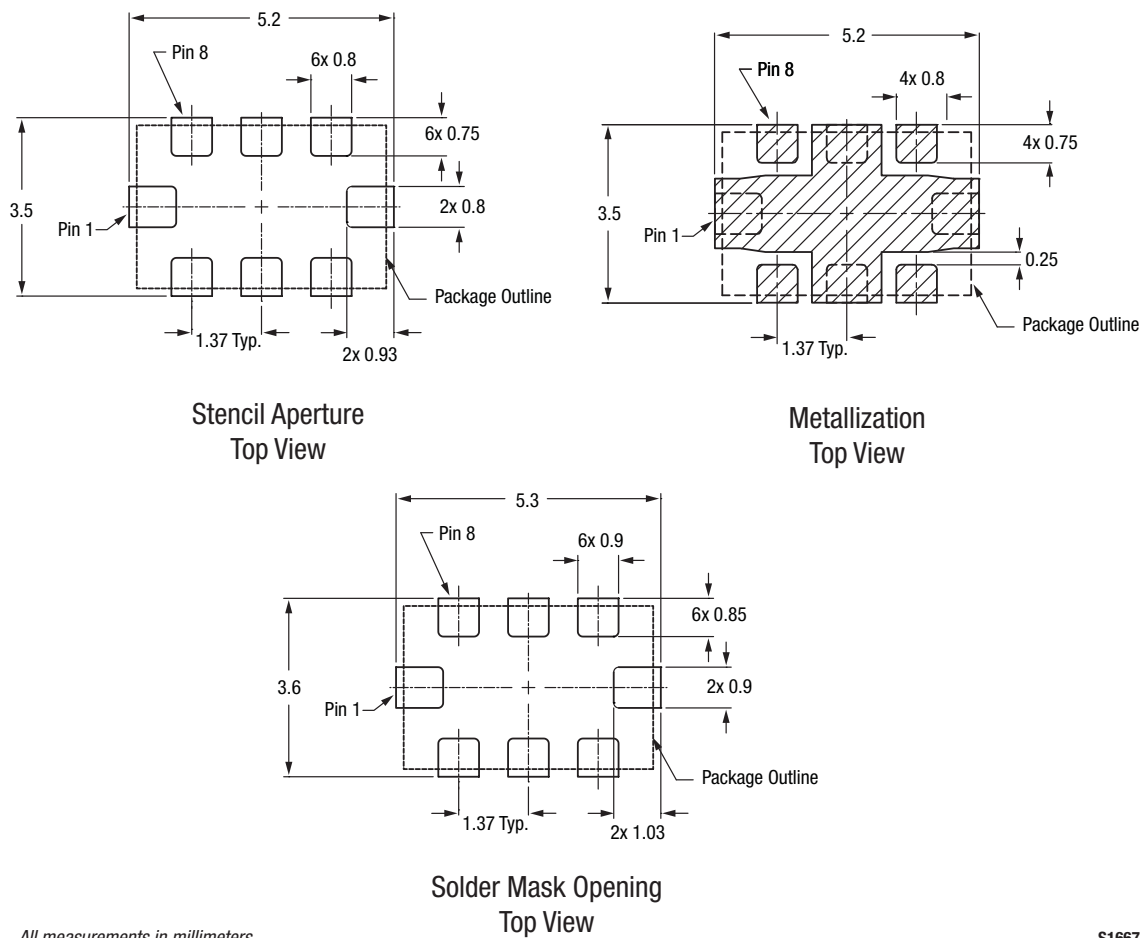

**Figure 11. SKY12236-11 PCB Layout Footprint**

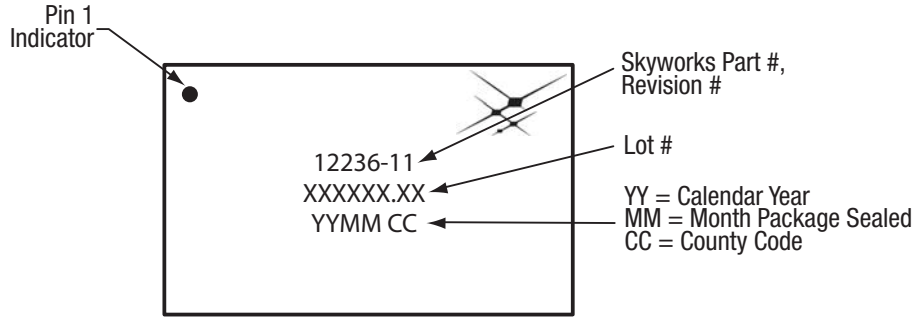

**Figure 12. Typical Part Markings (Top View)**

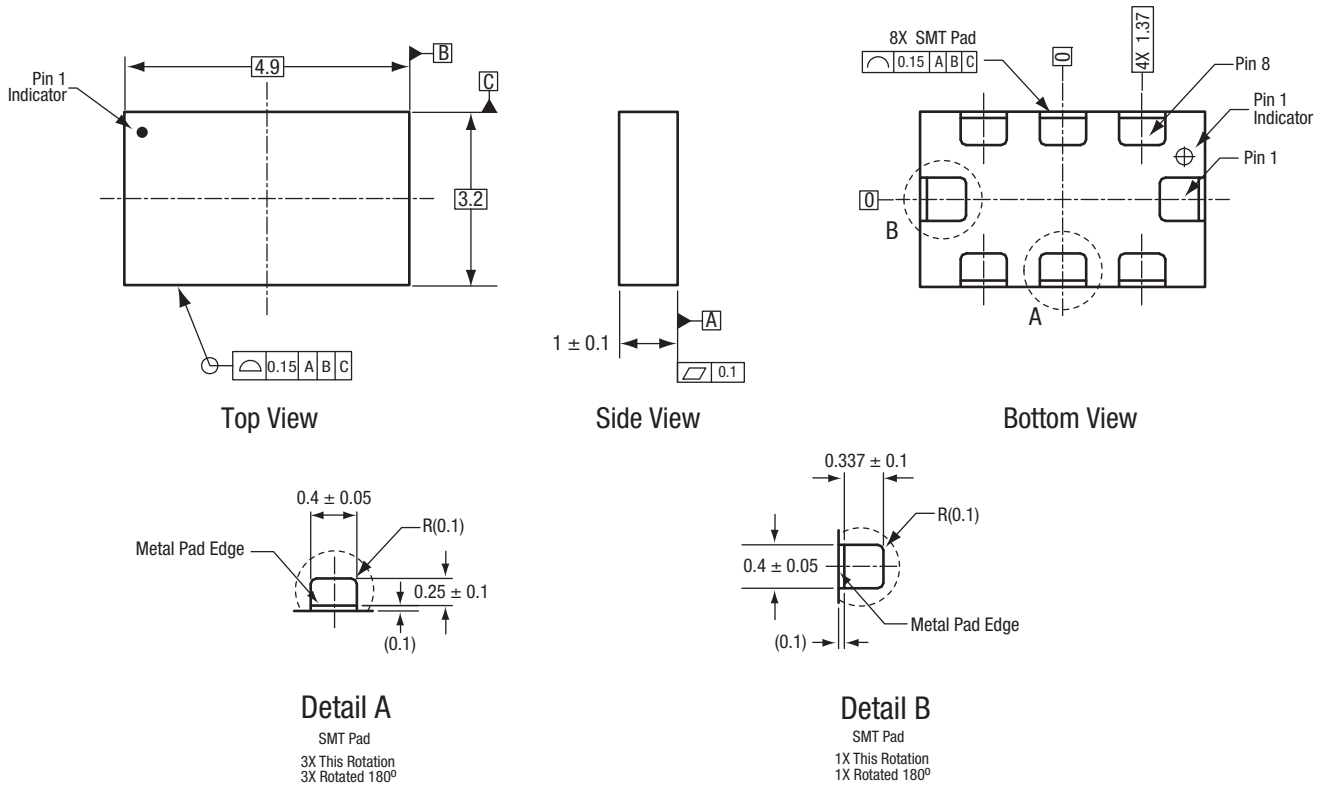

All measurements are in millimeters.

Dimensioning and tolerancing according to ASME Y14.5M-1994.

S1554

**Figure 13. SKY12236-11 8-Pin MCM Package Dimensions**

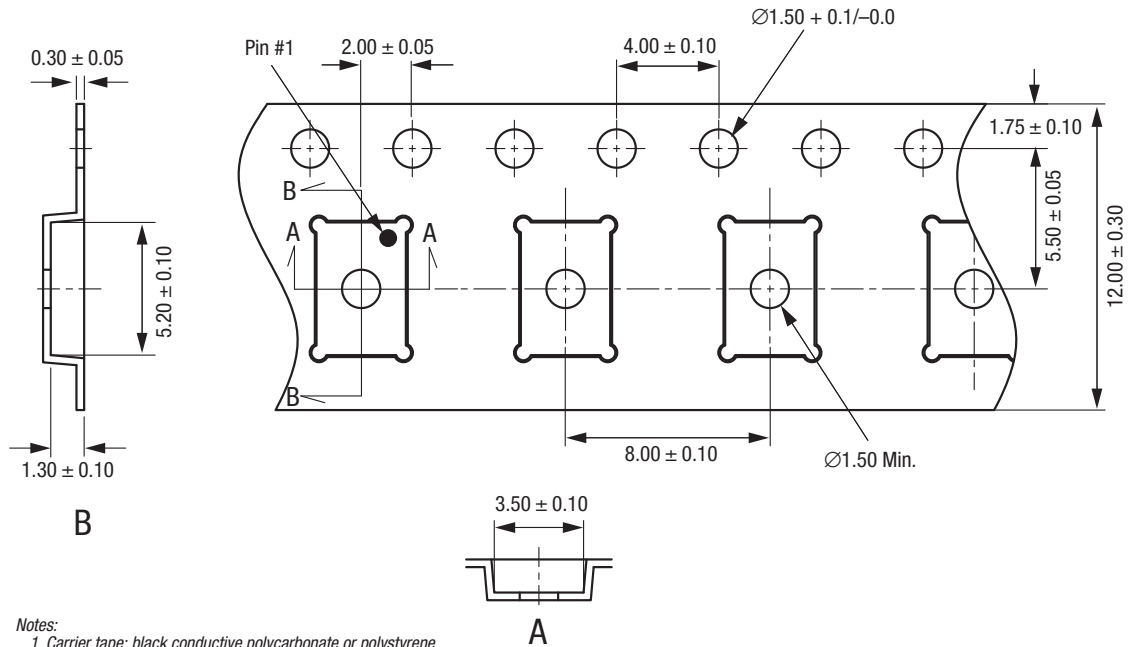

- Notes:
1. Carrier tape: black conductive polycarbonate or polystyrene.
  2. Cover tape material: transparent conductive PSA.
  3. Cover tape size: 9.30 mm width.
  4. Sprocket hole (10) pitch cumulative tolerance:  $\pm 0.20$  mm.
  5. All measurements are in millimeters.

S1680

Figure 14. SKY12236-11 Tape and Reel Dimensions



**Ordering Information**

Model Name	Manufacturing Part Number	Evaluation Board Part Number
SKY12236-11: Voltage Controlled Variable Attenuator	SKY12236-11	SKY12236-11-EVB

Copyright © 2012-2014 Skyworks Solutions, Inc. All Rights Reserved.

Information in this document is provided in connection with Skyworks Solutions, Inc. ("Skyworks") products or services. These materials, including the information contained herein, are provided by Skyworks as a service to its customers and may be used for informational purposes only by the customer. Skyworks assumes no responsibility for errors or omissions in these materials or the information contained herein. Skyworks may change its documentation, products, services, specifications or product descriptions at any time, without notice. Skyworks makes no commitment to update the materials or information and shall have no responsibility whatsoever for conflicts, incompatibilities, or other difficulties arising from any future changes.

No license, whether express, implied, by estoppel or otherwise, is granted to any intellectual property rights by this document. Skyworks assumes no liability for any materials, products or information provided hereunder, including the sale, distribution, reproduction or use of Skyworks products, information or materials, except as may be provided in Skyworks Terms and Conditions of Sale.

THE MATERIALS, PRODUCTS AND INFORMATION ARE PROVIDED "AS IS" WITHOUT WARRANTY OF ANY KIND, WHETHER EXPRESS, IMPLIED, STATUTORY, OR OTHERWISE, INCLUDING FITNESS FOR A PARTICULAR PURPOSE OR USE, MERCHANTABILITY, PERFORMANCE, QUALITY OR NON-INFRINGEMENT OF ANY INTELLECTUAL PROPERTY RIGHT; ALL SUCH WARRANTIES ARE HEREBY EXPRESSLY DISCLAIMED. SKYWORKS DOES NOT WARRANT THE ACCURACY OR COMPLETENESS OF THE INFORMATION, TEXT, GRAPHICS OR OTHER ITEMS CONTAINED WITHIN THESE MATERIALS. SKYWORKS SHALL NOT BE LIABLE FOR ANY DAMAGES, INCLUDING BUT NOT LIMITED TO ANY SPECIAL, INDIRECT, INCIDENTAL, STATUTORY, OR CONSEQUENTIAL DAMAGES, INCLUDING WITHOUT LIMITATION, LOST REVENUES OR LOST PROFITS THAT MAY RESULT FROM THE USE OF THE MATERIALS OR INFORMATION, WHETHER OR NOT THE RECIPIENT OF MATERIALS HAS BEEN ADVISED OF THE POSSIBILITY OF SUCH DAMAGE.

Skyworks products are not intended for use in medical, lifesaving or life-sustaining applications, or other equipment in which the failure of the Skyworks products could lead to personal injury, death, physical or environmental damage. Skyworks customers using or selling Skyworks products for use in such applications do so at their own risk and agree to fully indemnify Skyworks for any damages resulting from such improper use or sale.

Customers are responsible for their products and applications using Skyworks products, which may deviate from published specifications as a result of design defects, errors, or operation of products outside of published parameters or design specifications. Customers should include design and operating safeguards to minimize these and other risks. Skyworks assumes no liability for applications assistance, customer product design, or damage to any equipment resulting from the use of Skyworks products outside of stated published specifications or parameters.

Skyworks, the Skyworks symbol, and "Breakthrough Simplicity" are trademarks or registered trademarks of Skyworks Solutions, Inc., in the United States and other countries. Third-party brands and names are for identification purposes only, and are the property of their respective owners. Additional information, including relevant terms and conditions, posted at [www.skyworksinc.com](http://www.skyworksinc.com), are incorporated by reference.



## Стандарт Электрон Связь

Мы молодая и активно развивающаяся компания в области поставок электронных компонентов. Мы поставляем электронные компоненты отечественного и импортного производства напрямую от производителей и с крупнейших складов мира.

Благодаря сотрудничеству с мировыми поставщиками мы осуществляем комплексные и плановые поставки широчайшего спектра электронных компонентов.

Собственная эффективная логистика и склад в обеспечивает надежную поставку продукции в точно указанные сроки по всей России.

Мы осуществляем техническую поддержку нашим клиентам и предпродажную проверку качества продукции. На все поставляемые продукты мы предоставляем гарантию .

Осуществляем поставки продукции под контролем ВП МО РФ на предприятия военно-промышленного комплекса России , а также работаем в рамках 275 ФЗ с открытием отдельных счетов в уполномоченном банке. Система менеджмента качества компании соответствует требованиям ГОСТ ISO 9001.

Минимальные сроки поставки, гибкие цены, неограниченный ассортимент и индивидуальный подход к клиентам являются основой для выстраивания долгосрочного и эффективного сотрудничества с предприятиями радиоэлектронной промышленности, предприятиями ВПК и научно-исследовательскими институтами России.

С нами вы становитесь еще успешнее!

### Наши контакты:

**Телефон:** +7 812 627 14 35

**Электронная почта:** [sales@st-electron.ru](mailto:sales@st-electron.ru)

**Адрес:** 198099, Санкт-Петербург,  
Промышленная ул, дом № 19, литера Н,  
помещение 100-Н Офис 331