



VNQ5050AK-E

Quad channel high side driver with analog current sense for automotive applications

Features

Parameters	Symbol	Value
Max supply voltage	V_{CC}	41 V
Operating voltage range	V_{CC}	4.5 to 36 V
Max on-state resistance (per ch.)	R_{ON}	50 m Ω
Current limitation (typ)	I_{LIMH}	19 A
Off-state supply current	I_S	2 $\mu A^{(1)}$

1. Typical value with all loads connected.

■ General features:

- Inrush current active management by power limitation
- Very low standby current
- 3.0V CMOS compatible input
- Optimized electromagnetic emission
- Very low electromagnetic susceptibility
- In compliance with the 2002/95/EC European directive

■ Diagnostic functions:

- Proportional load current sense
- High current sense precision for wide current range
- Current sense disable
- Thermal shutdown indication
- Very low current sense leakage

■ Protection:

- Undervoltage shutdown
- Overvoltage clamp
- Load current limitation
- Self limiting of fast thermal transients
- Protection against loss of ground and loss of V_{CC}
- Thermal shutdown



- Reverse battery protection (see [Figure 25](#))
- Electrostatic discharge protection

Application

- All types of resistive, inductive and capacitive loads.
- Suitable as LED driver.

Description

The VNQ5050AK-E is a monolithic device made using STMicroelectronics VIPower M0-5 technology. It is intended for driving resistive or inductive loads with one side connected to ground. Active V_{CC} pin voltage clamp protects the device against low energy spikes (see ISO7637 transient compatibility table).

This device integrates an analog current sense which delivers a current proportional to the load current (according to a known ratio) when CS_DIS is driven low or left open. When CS_DIS is driven high, the CURRENT SENSE pin is in a high impedance condition.

Output current limitation protects the device in overload condition. In case of long overload duration, the device limits the dissipated power to a safe level up to thermal shutdown intervention. Thermal shutdown with automatic restart allows the device to recover normal operation as soon as the fault condition disappears.

Table 1. Device summary

Package	Order codes	
	Tube	Tape and Reel
PowerSSO-24	VNQ5050AK-E	VNQ5050AKTR-E

Contents

- 1 Block diagram and pin configuration 5**

- 2 Electrical specifications 7**
 - 2.1 Absolute maximum ratings 7
 - 2.2 Thermal data 8
 - 2.3 Electrical characteristics 9
 - 2.4 Electrical characteristics curves 17

- 3 Application information 20**
 - 3.1 GND protection network against reverse battery 20
 - 3.1.1 Solution 1: resistor in the ground line (RGND only) 20
 - 3.1.2 Solution 2: a diode (DGND) in the ground line. 21
 - 3.2 Load dump protection 21
 - 3.3 Microcontroller I/Os protection 21
 - 3.4 Maximum demagnetization energy (VCC = 13.5V) 23

- 4 Package and PC board thermal data 24**
 - 4.1 PowerSSO-24 thermal data 24

- 5 Package and packing information 27**
 - 5.1 ECOPACK® packages 27
 - 5.2 PowerSSO-24™ mechanical data 27
 - 5.3 Packing information 29

- 6 Revision history 30**



List of tables

Table 1.	Device summary	1
Table 2.	Pin functions	5
Table 3.	Suggested connections for unused and not connected pins	6
Table 4.	Absolute maximum ratings	7
Table 5.	Thermal data	8
Table 6.	Power section	9
Table 7.	Switching ($V_{CC}=13V$)	9
Table 8.	Current sense ($8V < V_{CC} < 16V$)	10
Table 9.	Protection	11
Table 10.	Logic input	12
Table 11.	Truth table.	15
Table 12.	Electrical transient requirements (part 1/3).	16
Table 13.	Electrical transient requirements (part 2/3).	16
Table 14.	Electrical transient requirements (part 3/3).	16
Table 15.	Thermal parameters	26
Table 16.	PowerSSO-24™ mechanical data	27
Table 17.	Document revision history	30

List of figures

Figure 1.	Block diagram	5
Figure 2.	Configuration diagram (top view)	6
Figure 3.	Current and voltage conventions	7
Figure 4.	Current sense delay characteristics	12
Figure 5.	Delay response time between rising edge of output current and rising edge of current sense (CS enabled)	13
Figure 6.	Switching characteristics	13
Figure 7.	I_{OUT}/I_{SENSE} vs I_{OUT}	14
Figure 8.	Maximum current sense ratio drift vs load current	14
Figure 9.	Output voltage drop limitation	15
Figure 10.	Off-state output current	17
Figure 11.	High level input current	17
Figure 12.	Input clamp voltage	17
Figure 13.	Input low level	17
Figure 14.	Input high level	17
Figure 15.	Input hysteresis voltage	17
Figure 16.	On-state resistance vs T_{case}	18
Figure 17.	On-state resistance vs V_{CC}	18
Figure 18.	Undervoltage shutdown	18
Figure 19.	Turn-on voltage slope	18
Figure 20.	I_{LIMH} vs T_{case}	18
Figure 21.	Turn-off voltage slope	18
Figure 22.	CS_DIS high level voltage	19
Figure 23.	CS_DIS clamp voltage	19
Figure 24.	CS_DIS low level voltage	19
Figure 25.	Application schematic	20
Figure 26.	Waveforms	22
Figure 27.	Maximum turn-off current versus inductance (for each channel)	23
Figure 28.	PowerSSO-24 PC board	24
Figure 29.	$R_{thj-amb}$ vs PCB copper area in open box free air condition (one channel on)	24
Figure 30.	PowerSSO-24 thermal impedance junction ambient single pulse (one channel on)	25
Figure 31.	Thermal fitting model of a double channel HSD in PowerSSO-24	25
Figure 32.	PowerSSO-24™ package dimensions	28
Figure 33.	PowerSSO-24 tube shipment (no suffix)	29
Figure 34.	PowerSSO-24 tape and reel shipment (suffix "TR")	29

1 Block diagram and pin configuration

Figure 1. Block diagram

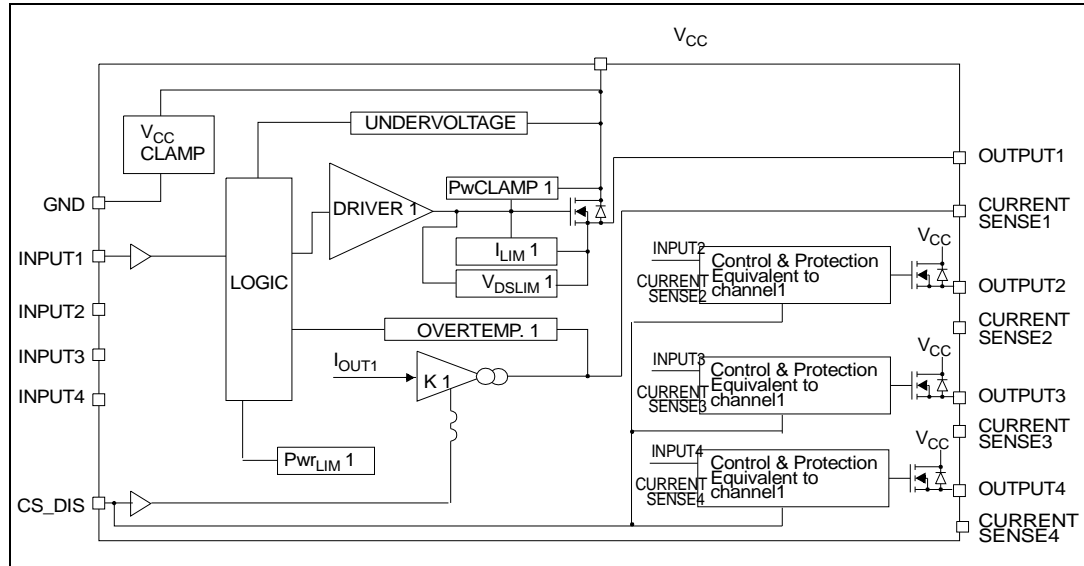

Table 2. Pin functions

Name	Function
V _{CC}	Battery connection
OUTPUT _n	Power output
GND	Ground connection. Must be reverse battery protected by an external diode/resistor network
INPUT _n	Voltage controlled input pin with hysteresis, CMOS compatible. Controls output switch state
CURRENT SENSE _n	Analog current sense pin, delivers a current proportional to the load current
CS_DIS	Active high CMOS compatible pin, to disable the current sense pin

Figure 2. Configuration diagram (top view)

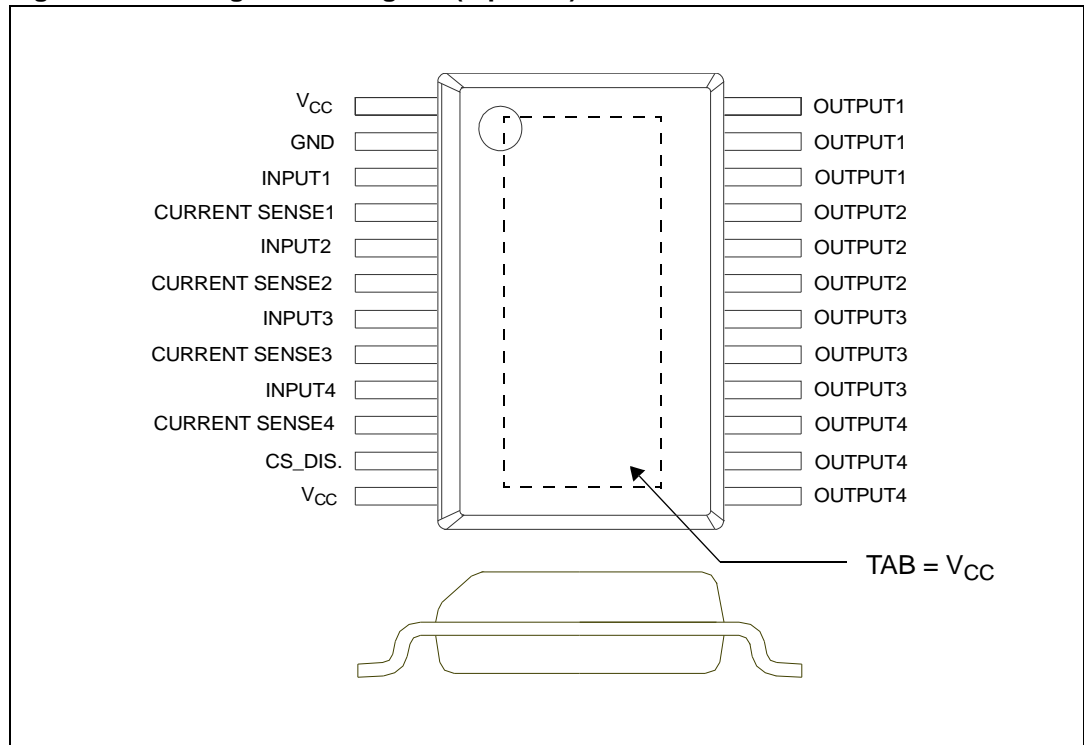

Table 3. Suggested connections for unused and not connected pins

Connection/pin	Current sense	N.C.	Output	Input	CS_DIS
Floating	N.R. ⁽¹⁾	X	X	X	X
To ground	Through 1 kΩ resistor	X	N.R.	Through 10 kΩ resistor	Through 10 kΩ resistor

1. Not recommended.

2 Electrical specifications

Figure 3. Current and voltage conventions

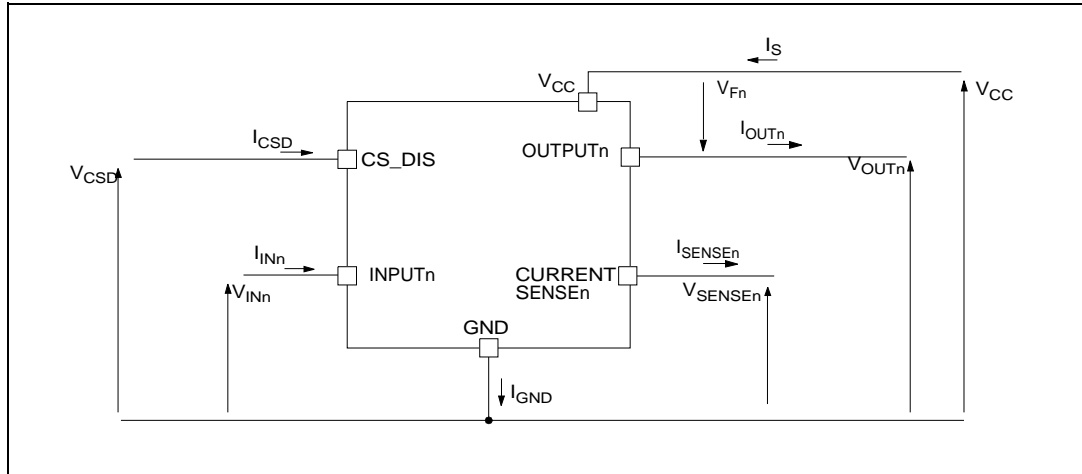

Note: $V_{Fn} = V_{OUTn} - V_{CC}$ during reverse battery condition.

2.1 Absolute maximum ratings

Stress values that exceed those listed in the “Absolute maximum ratings” table can cause permanent damage to the device. These are stress ratings only, and operation of the device at these, or any other conditions greater than those, indicated in the operating sections of this specification is not implied. Exposure to absolute maximum rating conditions for extended periods may affect device reliability. Refer also to the STMicroelectronics sure program and other relevant quality documents.

Table 4. Absolute maximum ratings

Symbol	Parameter	Value	Unit
V_{CC}	DC supply voltage	41	V
$-V_{CC}$	Reverse DC supply voltage	0.3	V
$-I_{GND}$	DC reverse ground pin current	200	mA
I_{OUT}	DC output current	Internally limited	A
$-I_{OUT}$	Reverse DC output current	20	A
I_{IN}	DC input current	-1 to 10	mA
I_{CSD}	DC current sense disable input current	-1 to 10	mA
$-I_{CSENSE}$	DC reverse CS pin current	200	mA
V_{CSENSE}	Current sense maximum voltage	$V_{CC}-41$ $+V_{CC}$	V V
E_{MAX}	Maximum switching energy (single pulse) ($L=3$ mH; $R_L=0$ Ω ; $V_{bat}=13.5$ V; $T_{jstart}=150$ $^{\circ}C$; $I_{OUT} = I_{limL}(Typ.)$)	104	mJ

Table 4. Absolute maximum ratings (continued)

Symbol	Parameter	Value	Unit
V _{ESD}	Electrostatic discharge (human body model: R=1.5KΩ; C=100pF)		
	– Input	4000	V
	– Current sense	2000	V
	– CS_DIS	4000	V
	– Output	5000	V
	– V _{CC}	5000	V
V _{ESD}	Charge device model (CDM-AEC-Q100-011)	750	V
T _j	Junction operating temperature	-40 to 150	°C
T _{stg}	Storage temperature	-55 to 150	°C

2.2 Thermal data

Table 5. Thermal data

Symbol	Parameter	Max value	Unit
R _{thj-case}	Thermal resistance junction-case (With one channel ON)	2.8	°C/W
R _{thj-amb}	Thermal resistance junction-ambient	See Figure 29	°C/W

2.3 Electrical characteristics

Values specified in this section are for $8\text{ V} < V_{CC} < 36\text{ V}$, $-40\text{ °C} < T_j < 150\text{ °C}$, unless otherwise stated.

Table 6. Power section

Symbol	Parameter	Test conditions	Min.	Typ.	Max.	Unit
V_{CC}	Operating supply voltage		4.5	13	36	V
V_{USD}	Undervoltage shutdown		-	3.5	4.5	V
$V_{USDhyst}$	Undervoltage shutdown hysteresis		-	0.5	-	V
R_{ON}	On-state resistance	$I_{OUT}=2\text{ A}$; $T_j=25\text{ °C}$ $I_{OUT}=2\text{ A}$; $T_j=150\text{ °C}$ $I_{OUT}=2\text{ A}$; $V_{CC}=5\text{ V}$; $T_j=25\text{ °C}$	-	-	50 100 65	mΩ mΩ mΩ
V_{clamp}	Clamp voltage	$I_S=20\text{ mA}$	41	46	52	V
I_S	Supply current	Off-State; $V_{CC}=13\text{ V}$; $T_j=25\text{ °C}$; $V_{IN}=V_{OUT}=V_{SENSE}=V_{CSD}=0\text{ V}$ On-State; $V_{CC}=13\text{ V}$; $V_{IN}=5\text{ V}$; $I_{OUT}=0\text{ A}$	-	2 ⁽¹⁾ 8	5 ⁽¹⁾ 14	μA mA
$I_{L(off)}$	Off-state output current ⁽²⁾	$V_{IN}=V_{OUT}=0\text{ V}$; $V_{CC}=13\text{ V}$; $T_j=25\text{ °C}$ $V_{IN}=V_{OUT}=0\text{ V}$; $V_{CC}=13\text{ V}$; $T_j=125\text{ °C}$	0 0	0.01	3 5	μA
V_F	Output - V_{CC} diode voltage ⁽²⁾	$-I_{OUT}=2\text{ A}$; $T_j=150\text{ °C}$	-	-	0.7	V

1. PowerMOS leakage included.

2. For each channel.

Table 7. Switching ($V_{CC}=13\text{V}$)

Symbol	Parameter	Test conditions	Min.	Typ.	Max.	Unit
$t_{d(on)}$	Turn-on delay time	$R_L=6.5\text{ Ω}$ (see Figure 6)	-	20	-	μs
$t_{d(off)}$	Turn-off delay time	$R_L=6.5\text{ Ω}$ (see Figure 6)	-	45	-	μs
$(dV_{OUT}/dt)_{on}$	Turn-on voltage slope	$R_L=6.5\text{ Ω}$	-	See Figure 19	-	V/μs
$(dV_{OUT}/dt)_{off}$	Turn-off voltage slope	$R_L=6.5\text{ Ω}$	-	See Figure 21	-	V/μs
W_{ON}	Switching energy losses during t_{won}	$R_L=6.5\text{ Ω}$ (see Figure 6)	-	0.15	-	mJ
W_{OFF}	Switching energy losses during t_{woff}	$R_L=6.5\text{ Ω}$ (see Figure 6)	-	0.3	-	mJ

Table 8. Current sense ($8V < V_{CC} < 16V$)

Symbol	Parameter	Test conditions	Min.	Typ.	Max.	Unit
K_0	I_{OUT}/I_{SENSE}	$I_{OUT} = 0.05 A$; $V_{SENSE} = 0.5 V$; $V_{CSD} = 0 V$; $T_j = -40 ^\circ C \dots 150 ^\circ C$	1340	2420	3460	
K_1	I_{OUT}/I_{SENSE}	$I_{OUT} = 1 A$; $V_{SENSE} = 0.5 V$; $V_{CSD} = 0 V$; $T_j = -40 ^\circ C \dots 150 ^\circ C$ $T_j = 25 ^\circ C \dots 150 ^\circ C$	1370 1510	1860 1860	2510 2210	
$dK_1/K_1^{(1)}$	Current sense ratio drift	$I_{OUT} = 1 A$; $V_{SENSE} = 0.5 V$; $V_{CSD} = 0 V$; $T_j = -40 ^\circ C$ to $150 ^\circ C$	-10	-	10	%
K_2	I_{OUT}/I_{SENSE}	$I_{OUT} = 2 A$; $V_{SENSE} = 4 V$; $V_{CSD} = 0 V$; $T_j = -40 ^\circ C \dots 150 ^\circ C$ $T_j = 25 ^\circ C \dots 150 ^\circ C$	1590 1600	1760 1760	2140 1930	
$dK_2/K_2^{(1)}$	Current sense ratio drift	$I_{OUT} = 2 A$; $V_{SENSE} = 4 V$; $V_{CSD} = 0 V$; $T_j = -40 ^\circ C$ to $150 ^\circ C$	-8	-	8	%
K_3	I_{OUT}/I_{SENSE}	$I_{OUT} = 4 A$; $V_{SENSE} = 4 V$; $V_{CSD} = 0 V$; $T_j = -40 ^\circ C \dots 150 ^\circ C$ $T_j = 25 ^\circ C \dots 150 ^\circ C$	1650 1650	1740 1740	1950 1830	-
$dK_3/K_3^{(1)}$	Current sense ratio drift	$I_{OUT} = 4 A$; $V_{SENSE} = 4 V$; $V_{CSD} = 0 V$; $T_j = -40 ^\circ C$ to $150 ^\circ C$	-5	-	5	%
I_{SENSE0}	Analog sense leakage current	$I_{OUT} = 0 A$; $V_{SENSE} = 0 V$; $V_{CSD} = 5 V$; $V_{IN} = 0 V$; $T_j = -40 ^\circ C \dots 150 ^\circ C$	0	-	1	μA
		$V_{CSD} = 0 V$; $V_{IN} = 5 V$; $T_j = -40 ^\circ C \dots 150 ^\circ C$	0	-	2	μA
		$I_{OUT} = 2 A$; $V_{SENSE} = 0 V$; $V_{CSD} = 5 V$; $V_{IN} = 5 V$; $T_j = -40 ^\circ C \dots 150 ^\circ C$	0	-	1	μA
I_{OL}	Openload ON state current detection threshold	$V_{IN} = 5 V$, $I_{SENSE} = 5 \mu A$	4	-	20	mA
V_{SENSE}	Max analog sense output voltage	$I_{OUT} = 4 A$; $V_{CSD} = 0 V$	5	-	-	V
V_{SENSEH}	Analog sense output voltage in over temperature condition	$V_{CC} = 13 V$; $R_{SENSE} = 10 K\Omega$	-	9	-	V

Table 8. Current sense (8V<V_{CC}<16V) (continued)

Symbol	Parameter	Test conditions	Min.	Typ.	Max.	Unit
I _{SENSEH}	Analog sense output current in over temperature condition	V _{CC} = 13 V; V _{SENSE} = 5 V	-	8	-	mA
t _{DSENSE1H}	Delay response time from falling edge of CS_DIS pin	V _{SENSE} <4 V, 0.5 A<I _{out} <4 A I _{SENSE} = 90 % of I _{SENSE max} (see Figure 4)	-	50	100	μs
t _{DSENSE1L}	Delay response time from rising edge of CS_DIS pin	V _{SENSE} <4 V, 0.5 A<I _{out} <4 A I _{SENSE} =10 % of I _{SENSE max} (see Figure 4)	-	5	20	μs
t _{DSENSE2H}	Delay response time from rising edge of INPUT pin	V _{SENSE} <4 V, 0.5 A<I _{out} <4 A I _{SENSE} =90 % of I _{SENSE max} (see Figure 4)	-	80	250	μs
Δt _{DSENSE2H}	Delay response time between rising edge of output current and rising edge of current sense	V _{SENSE} <4 V, I _{SENSE} =90 % of I _{SENSEMAX} , I _{OUT} =90 % of I _{OUTMAX} I _{OUTMAX} =2 A (see Figure 5)	-	-	65	μs
t _{DSENSE2L}	Delay response time from falling edge of INPUT pin	V _{SENSE} <4 V, 0.5 A<I _{out} <4 A I _{SENSE} =10 % of I _{SENSE max} (see Figure 4)	-	100	250	μs

1. Parameter guaranteed by design; it is not tested.

Table 9. Protection⁽¹⁾

Symbol	Parameter	Test conditions	Min.	Typ.	Max.	Unit
I _{limH}	DC short circuit current	V _{CC} =13 V 5 V<V _{CC} <36 V	13.5	19	26.5 26.5	A A
I _{limL}	Short circuit current during thermal cycling	V _{CC} =13 V; T _R <T _j <T _{TSD}	-	7	-	A
T _{TSD}	Shutdown temperature		150	175	200	°C
T _R	Reset temperature		T _{RS} + 1	T _{RS} + 5	-	°C
T _{RS}	Thermal reset of STATUS		135	-	-	°C
T _{HYST}	Thermal hysteresis (T _{TSD} -T _R)		-	7	-	°C
V _{DEMAG}	Turn-off output voltage clamp	I _{OUT} =2 A; V _{IN} =0; L=6 mH	V _{CC} -41	V _{CC} -46	V _{CC} -52	V
V _{ON}	Output voltage drop limitation	I _{OUT} =0.1 A; T _j =-40 °C...150 °C (see Figure 9)	-	25	-	mV

1. To ensure long term reliability under heavy overload or short circuit conditions, protection and related diagnostic signals must be used together with a proper software strategy. If the device is subjected to abnormal conditions, this software must limit the duration and number of activation cycles.

Table 10. Logic input

Symbol	Parameter	Test conditions	Min.	Typ.	Max.	Unit
V_{IL}	Input low level voltage		-	-	0.9	V
I_{IL}	Low level input current	$V_{IN} = 0.9\text{ V}$	1	-	-	μA
V_{IH}	Input high level voltage		2.1	-	-	V
I_{IH}	High level input current	$V_{IN} = 2.1\text{ V}$	-	-	10	μA
$V_{I(hyst)}$	Input hysteresis voltage		0.25	-	-	V
V_{ICL}	Input clamp voltage	$I_{IN} = 1\text{ mA}$ $I_{IN} = -1\text{ mA}$	5.5	-0.7	7	V V
V_{CSDL}	CS_DIS low level voltage		-	-	0.9	V
I_{CSDL}	Low level CS_DIS current	$V_{CSD} = 0.9\text{ V}$	1	-	-	μA
V_{CSDH}	CS_DIS high level voltage		2.1	-	-	V
I_{CSDH}	High level CS_DIS current	$V_{CSD} = 2.1\text{ V}$	-	-	10	μA
$V_{CSD(hyst)}$	CS_DIS hysteresis voltage		0.25	-	-	V
V_{CSCL}	CS_DIS clamp voltage	$I_{CSD} = 1\text{ mA}$ $I_{CSD} = -1\text{ mA}$	5.5	-0.7	7	V V

Figure 4. Current sense delay characteristics

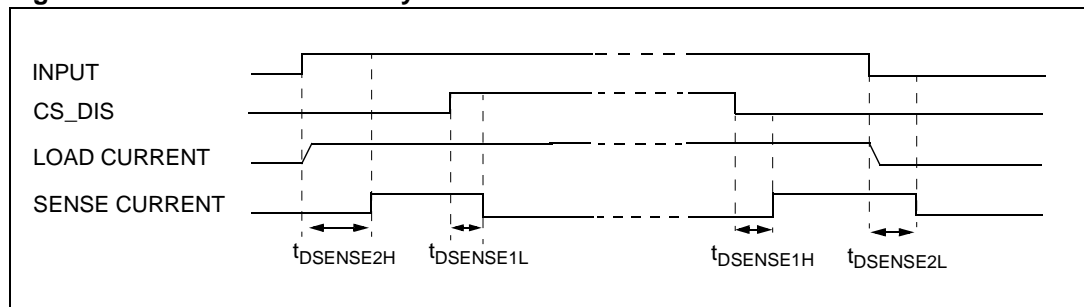

Figure 5. Delay response time between rising edge of output current and rising edge of current sense (CS enabled)

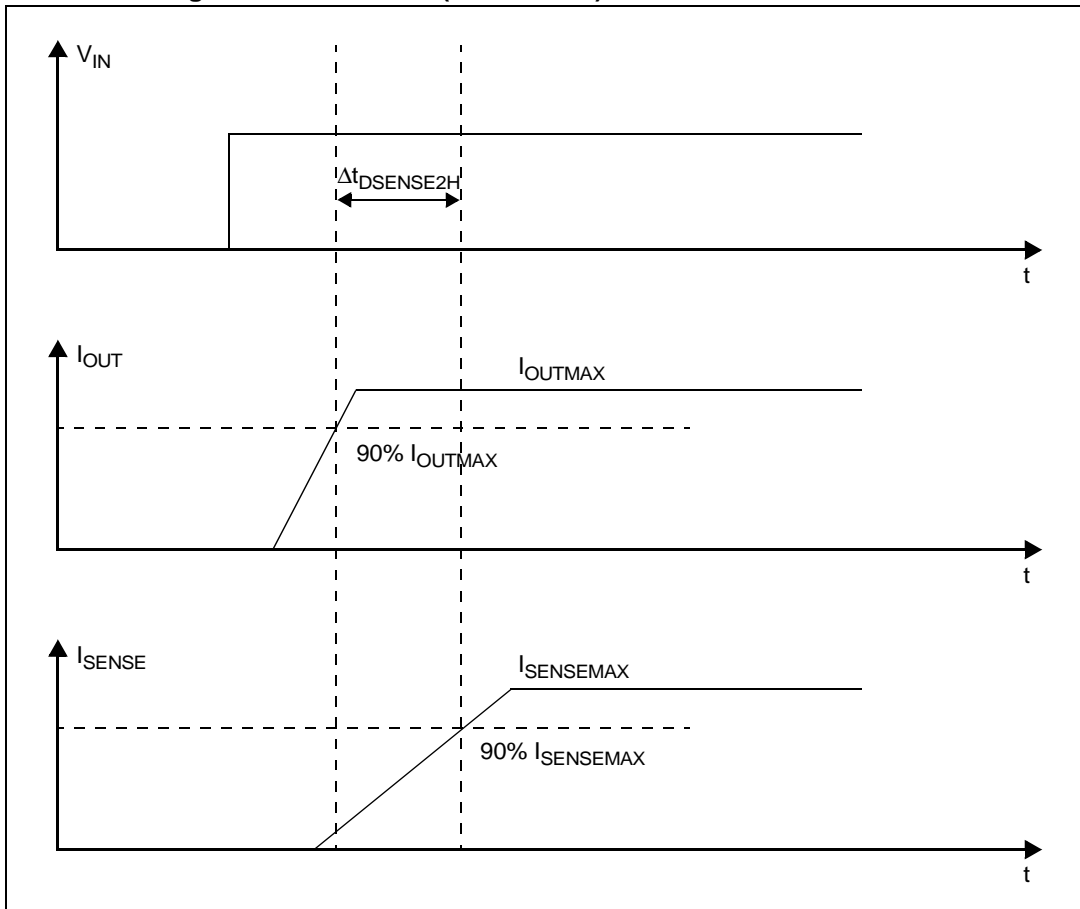

Figure 6. Switching characteristics

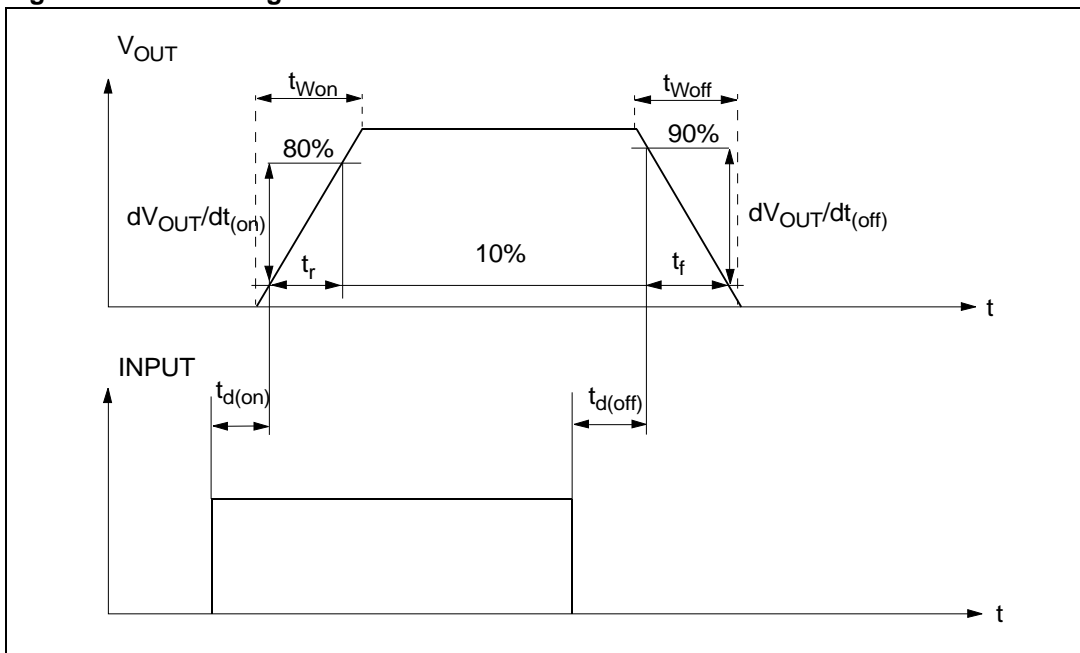

Figure 7. I_{OUT}/I_{SENSE} vs I_{OUT}

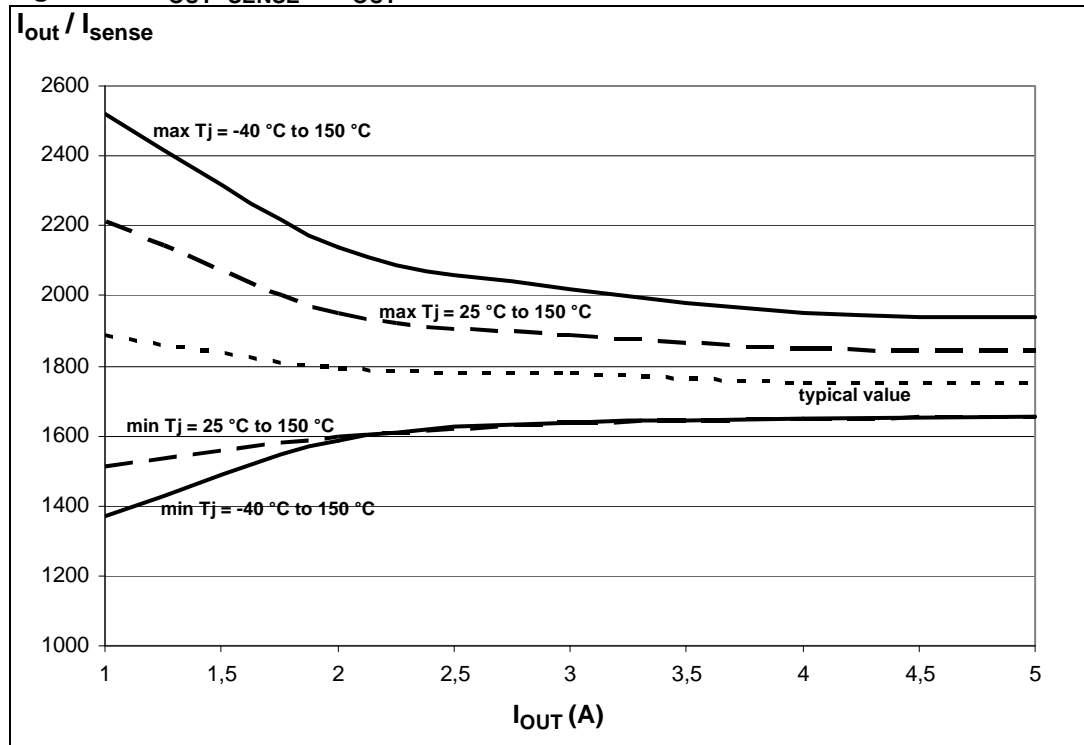
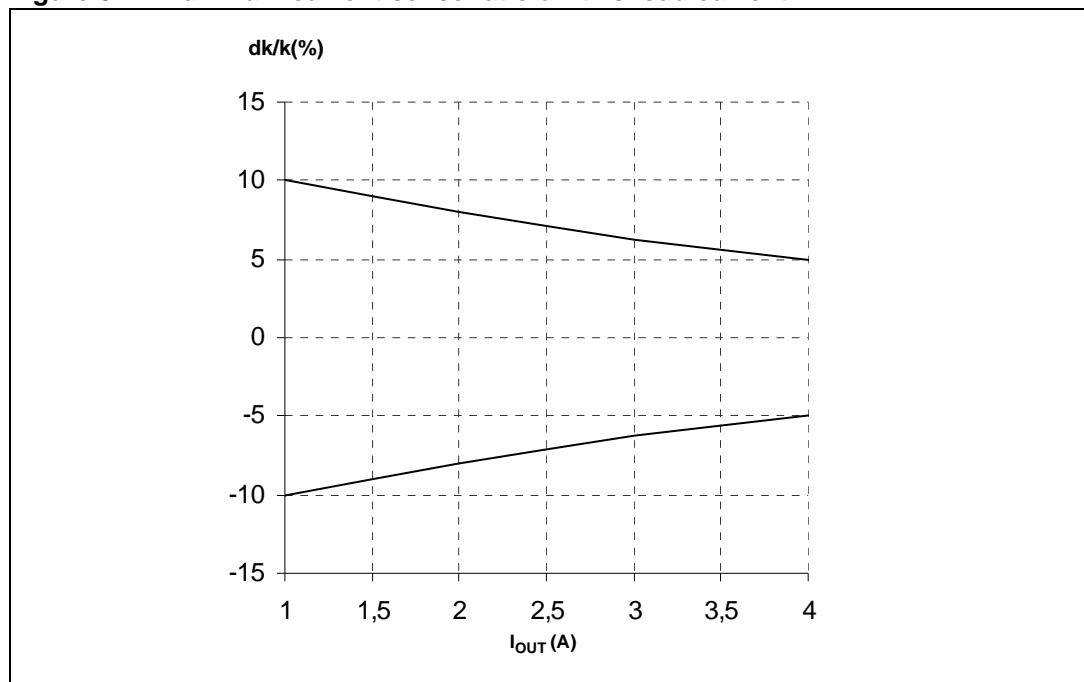

Figure 8. Maximum current sense ratio drift vs load current



Note: Parameter guaranteed by design; it is not tested.

Table 11. Truth table

Conditions	Input	Output	Sense ($V_{CSD}=0\text{ V}$) ⁽¹⁾
Normal operation	L	L	0
	H	H	Nominal
Over temperature	L	L	0
	H	L	V_{SENSEH}
Undervoltage	L	L	0
	H	L	0
Short circuit to GND ($R_{sc} \leq 10\text{ m}\Omega$)	L	L	0
	H	L	0 if $T_j < T_{TSD}$
	H	L	V_{SENSEH} if $T_j > T_{TSD}$
Short circuit to V_{CC}	L	H	0
	H	H	< Nominal
Negative output voltage clamp	L	L	0

1. If the V_{CSD} is high, the SENSE output is at a high impedance, its potential depends on leakage currents and external circuit.

Figure 9. Output voltage drop limitation

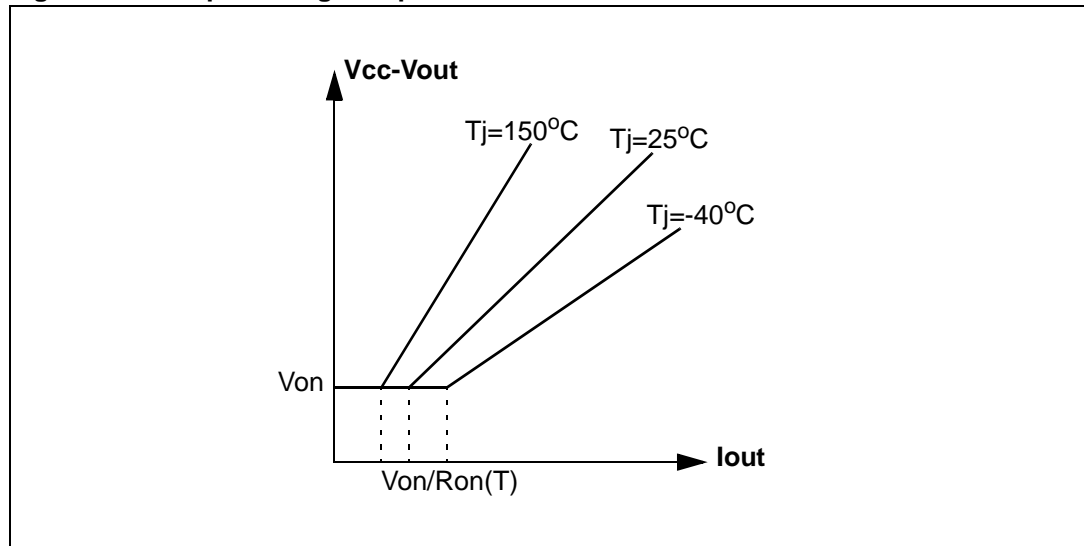

Table 12. Electrical transient requirements (part 1/3)

ISO 7637-2: 2004(E) test pulse	Test levels		Number of pulses or test times	Burst cycle/pulse repetition time		Delays and Impedance
	III	IV				
1	-75 V	-100 V	5000 pulses	0.5 s	5 s	2 ms, 10 Ω
2a	+37 V	+50 V	5000 pulses	0.2 s	5 s	50 μs, 2 Ω
3a	-100 V	-150 V	1h	90 ms	100 ms	0.1 μs, 50 Ω
3b	+75 V	+100 V	1h	90 ms	100 ms	0.1 μs, 50 Ω
4	-6 V	-7 V	1 pulse	-		100 ms, 0.01 Ω
5b ⁽²⁾	+65 V	+87 V	1 pulse	-		400 ms, 2 Ω

Table 13. Electrical transient requirements (part 2/3)

ISO 7637-2: 2004(E) test pulse	Test level results ⁽¹⁾	
	III	IV
1	C	C
2a	C	C
3a	C	C
3b	C	C
4	C	C
5b ⁽²⁾	C	C

1. The above test levels must be considered referred to Vcc = 13.5V except for pulse 5b.
2. Valid in case of external load dump clamp: 40V maximum referred to ground.

Table 14. Electrical transient requirements (part 3/3)

Class	Contents
C	All functions of the device are performed as designed after exposure to disturbance.
E	One or more functions of the device are not performed as designed after exposure to disturbance and cannot be returned to proper operation without replacing the device.

2.4 Electrical characteristics curves

Figure 10. Off-state output current

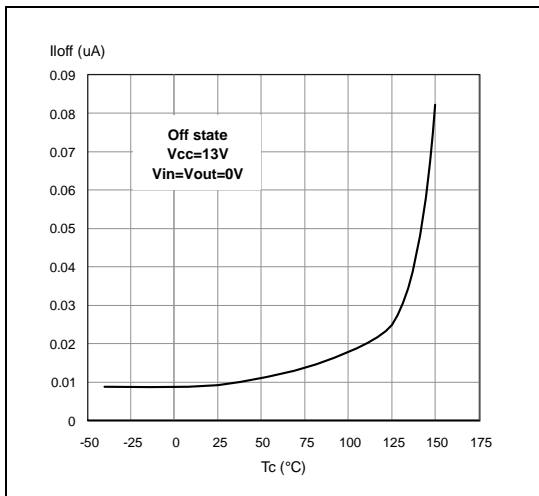

Figure 11. High level input current

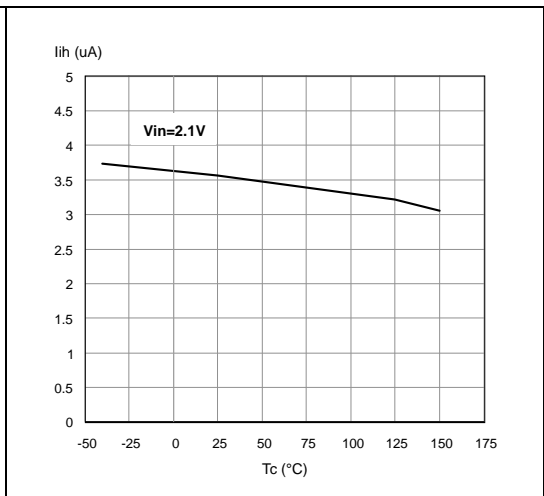

Figure 12. Input clamp voltage

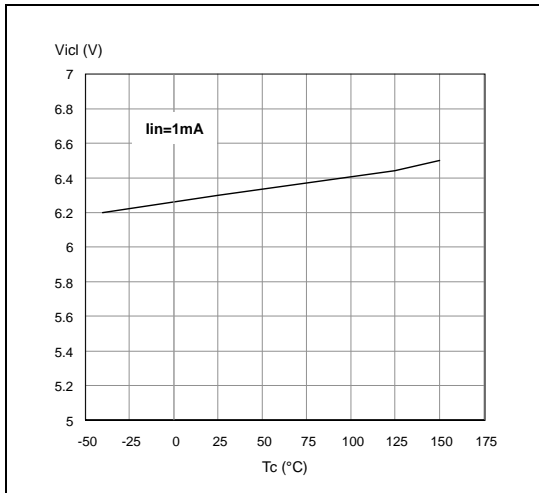

Figure 13. Input low level

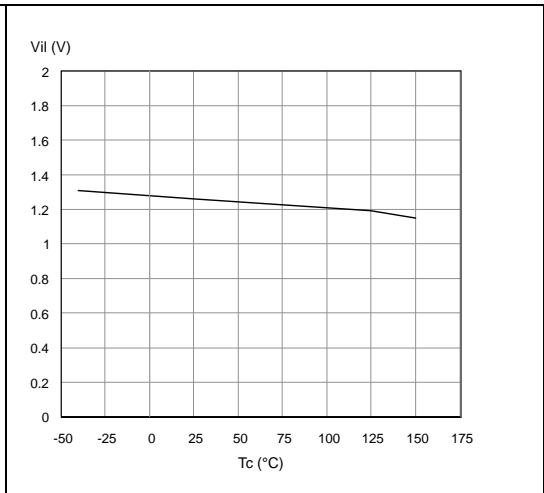

Figure 14. Input high level

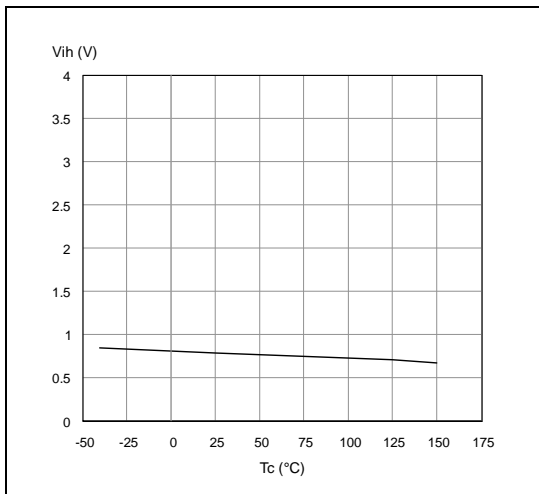

Figure 15. Input hysteresis voltage

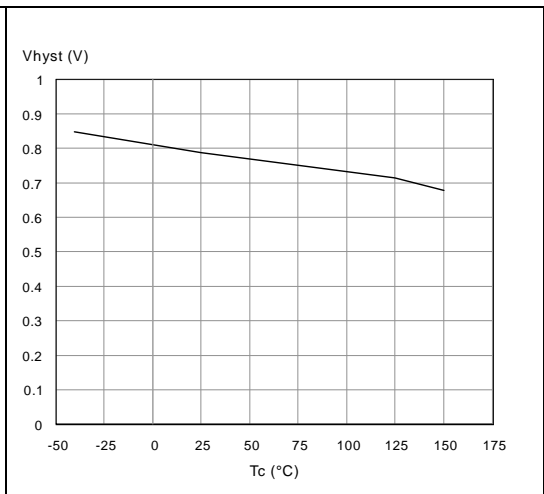

Figure 16. On-state resistance vs T_{case}

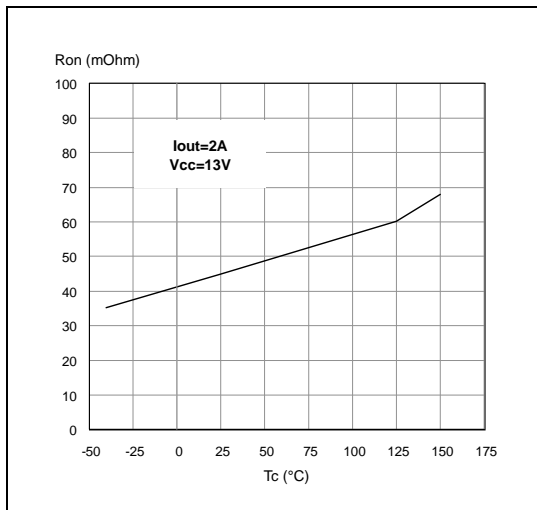

Figure 17. On-state resistance vs V_{CC}

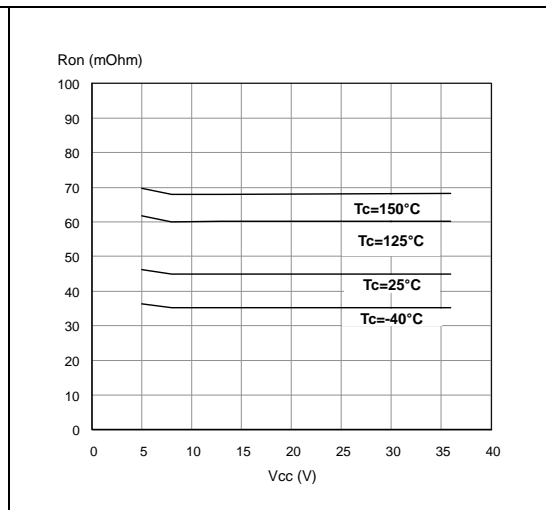

Figure 18. Undervoltage shutdown

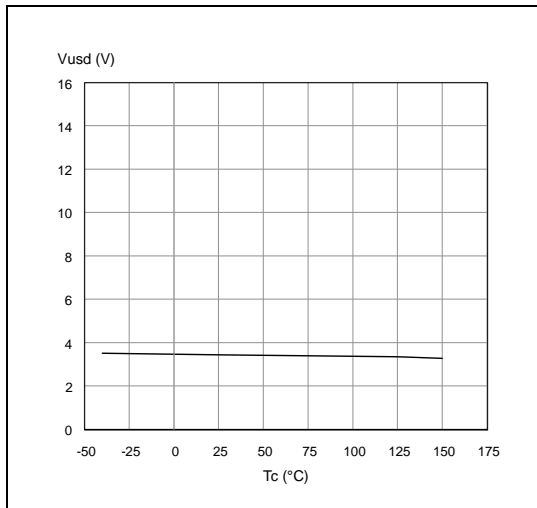

Figure 19. Turn-on voltage slope

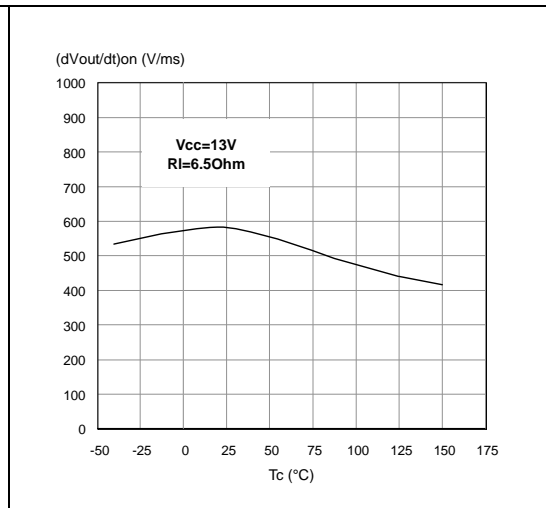

Figure 20. I_{LIMH} vs T_{case}

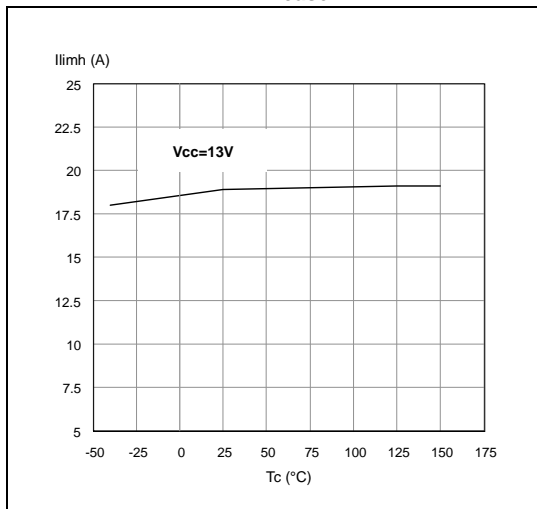

Figure 21. Turn-off voltage slope

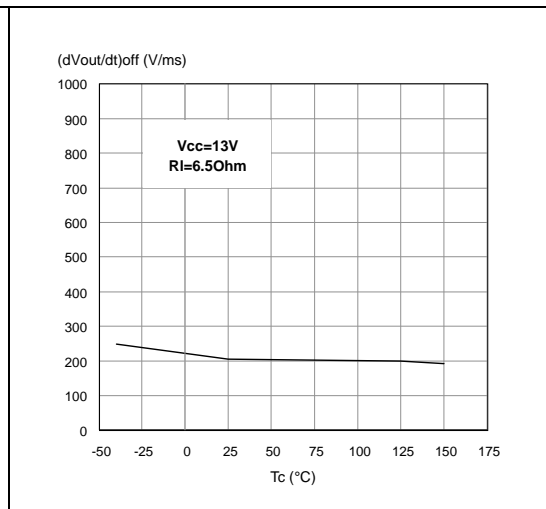

Figure 22. CS_DIS high level voltage

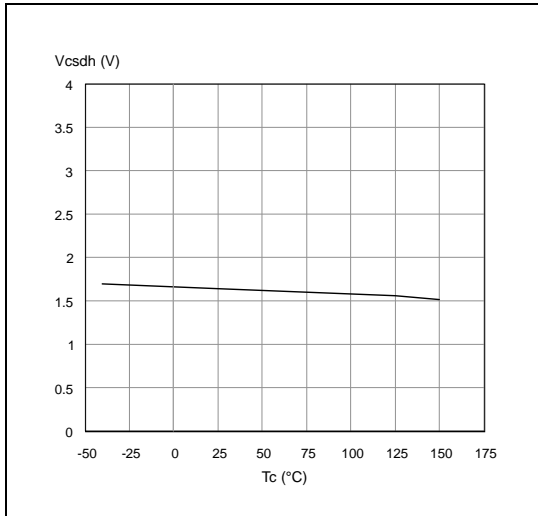

Figure 23. CS_DIS clamp voltage

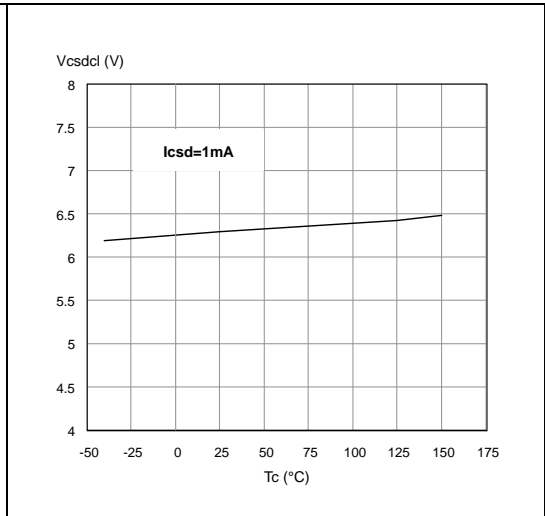
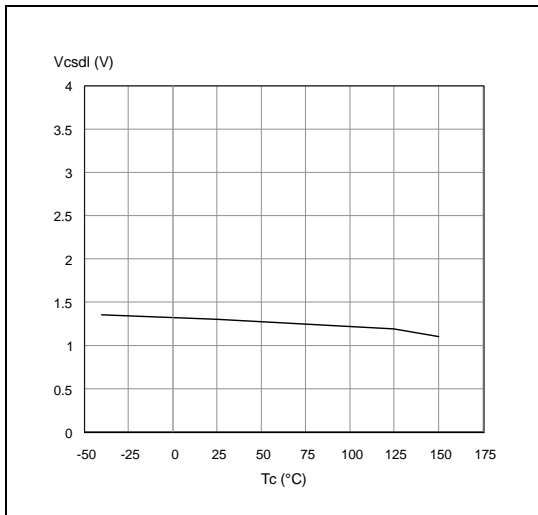
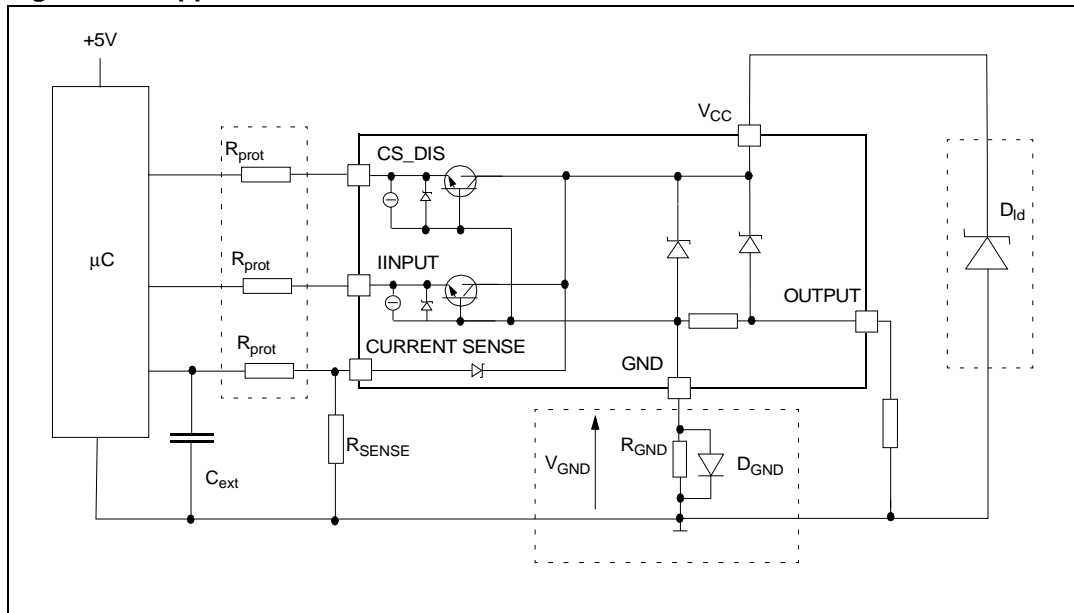

Figure 24. CS_DIS low level voltage



3 Application information

Figure 25. Application schematic



Note: Channel 2, 3, 4 have the same internal circuit as channel 1.

3.1 GND protection network against reverse battery

3.1.1 Solution 1: resistor in the ground line (R_GND only)

This can be used with any type of load.

The following is an indication on how to dimension the R_GND resistor.

1. $R_{GND} \leq 600 \text{ mV} / (I_{S(on)max})$.
2. $R_{GND} \geq (-V_{CC}) / (-I_{GND})$

where $-I_{GND}$ is the DC reverse ground pin current and can be found in the absolute maximum rating section of the device datasheet.

Power Dissipation in R_GND (when $V_{CC} < 0$: during reverse battery situations) is:

$$P_D = (-V_{CC})^2 / R_{GND}$$

This resistor can be shared amongst several different HSDs. Please note that the value of this resistor should be calculated with formula (1) where $I_{S(on)max}$ becomes the sum of the maximum on-state currents of the different devices.

Please note that if the microprocessor ground is not shared by the device ground then the R_GND will produce a shift ($I_{S(on)max} * R_{GND}$) in the input thresholds and the status output values. This shift will vary depending on how many devices are ON in the case of several high side drivers sharing the same R_GND.

If the calculated power dissipation leads to a large resistor or several devices have to share the same resistor then ST suggests to utilize Solution 2 (see below).

3.1.2 Solution 2: a diode (D_{GND}) in the ground line.

A resistor ($R_{GND} = 1 \text{ k}\Omega$) should be inserted in parallel to D_{GND} if the device drives an inductive load.

This small signal diode can be safely shared amongst several different HSDs. Also in this case, the presence of the ground network will produce a shift ($\approx 600\text{mV}$) in the input threshold and in the status output values if the microprocessor ground is not common to the device ground. This shift will not vary if more than one HSD shares the same diode/resistor network.

3.2 Load dump protection

D_{ld} is necessary (Voltage Transient Suppressor) if the load dump peak voltage exceeds the V_{CC} max DC rating. The same applies if the device is subject to transients on the V_{CC} line that are greater than the ones shown in the ISO T/R 7637/1 table.

3.3 Microcontroller I/Os protection

If a ground protection network is used and negative transients are present on the V_{CC} line, the control pins will be pulled negative. ST suggests to insert a resistor (R_{prot}) in line to prevent the μC I/Os pins to latch-up.

The value of these resistors is a compromise between the leakage current of μC and the current required by the HSD I/Os (Input levels compatibility) with the latch-up limit of μC I/Os.

$$-V_{CCpeak}/I_{latchup} \leq R_{prot} \leq (V_{OH\mu C} - V_{IH} - V_{GND}) / I_{IHmax}$$

Calculation example:

For $V_{CCpeak} = -100 \text{ V}$ and $I_{latchup} \geq 20 \text{ mA}$; $V_{OH\mu C} \geq 4.5 \text{ V}$

$$5 \text{ k}\Omega \leq R_{prot} \leq 180 \text{ k}\Omega.$$

Recommended values: $R_{prot} = 10 \text{ k}\Omega$, $C_{EXT} = 10 \text{ nF}$.

Figure 26. Waveforms

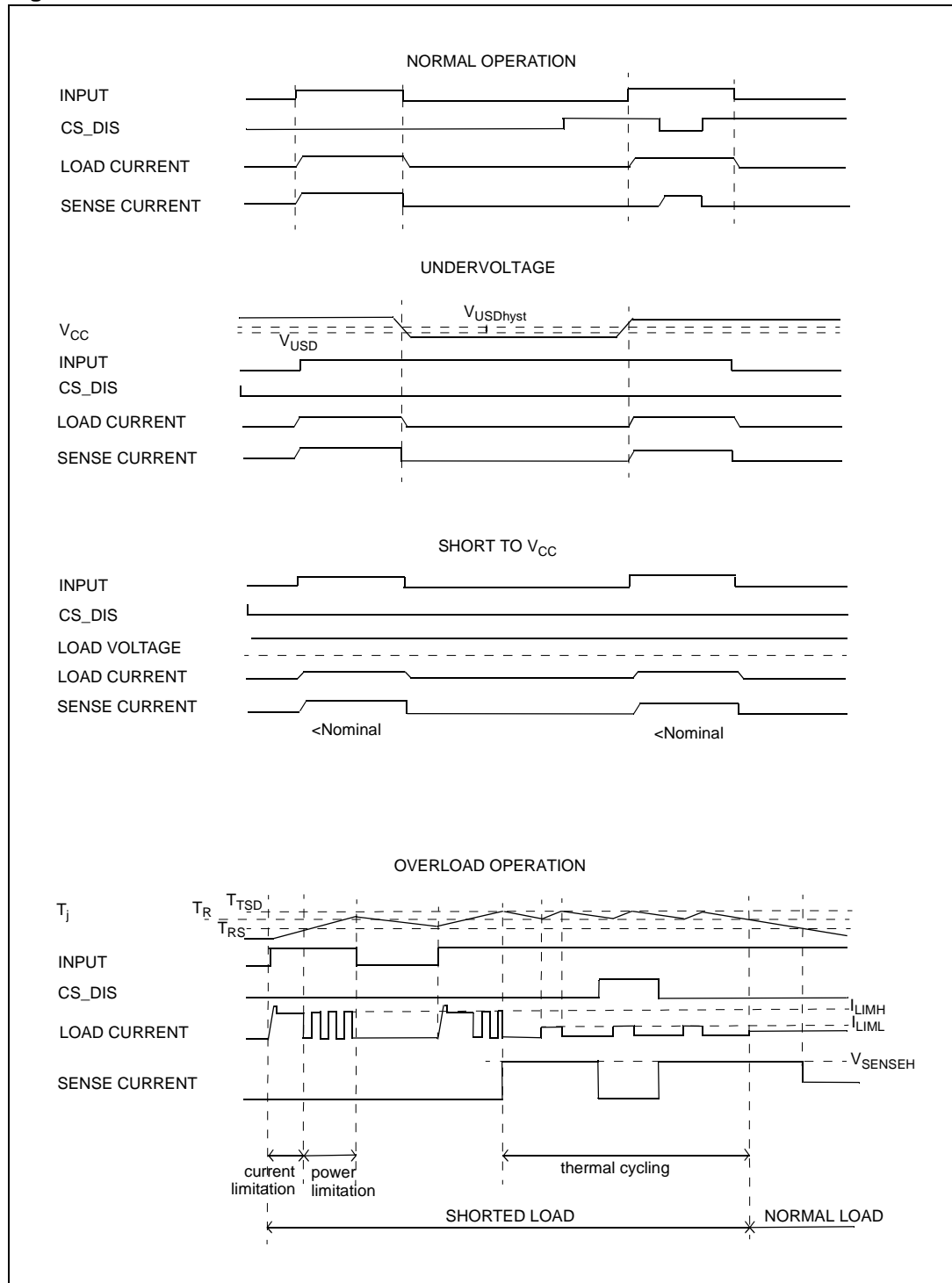

3.4 Maximum demagnetization energy ($V_{CC} = 13.5V$)

Figure 27. Maximum turn-off current versus inductance (for each channel)

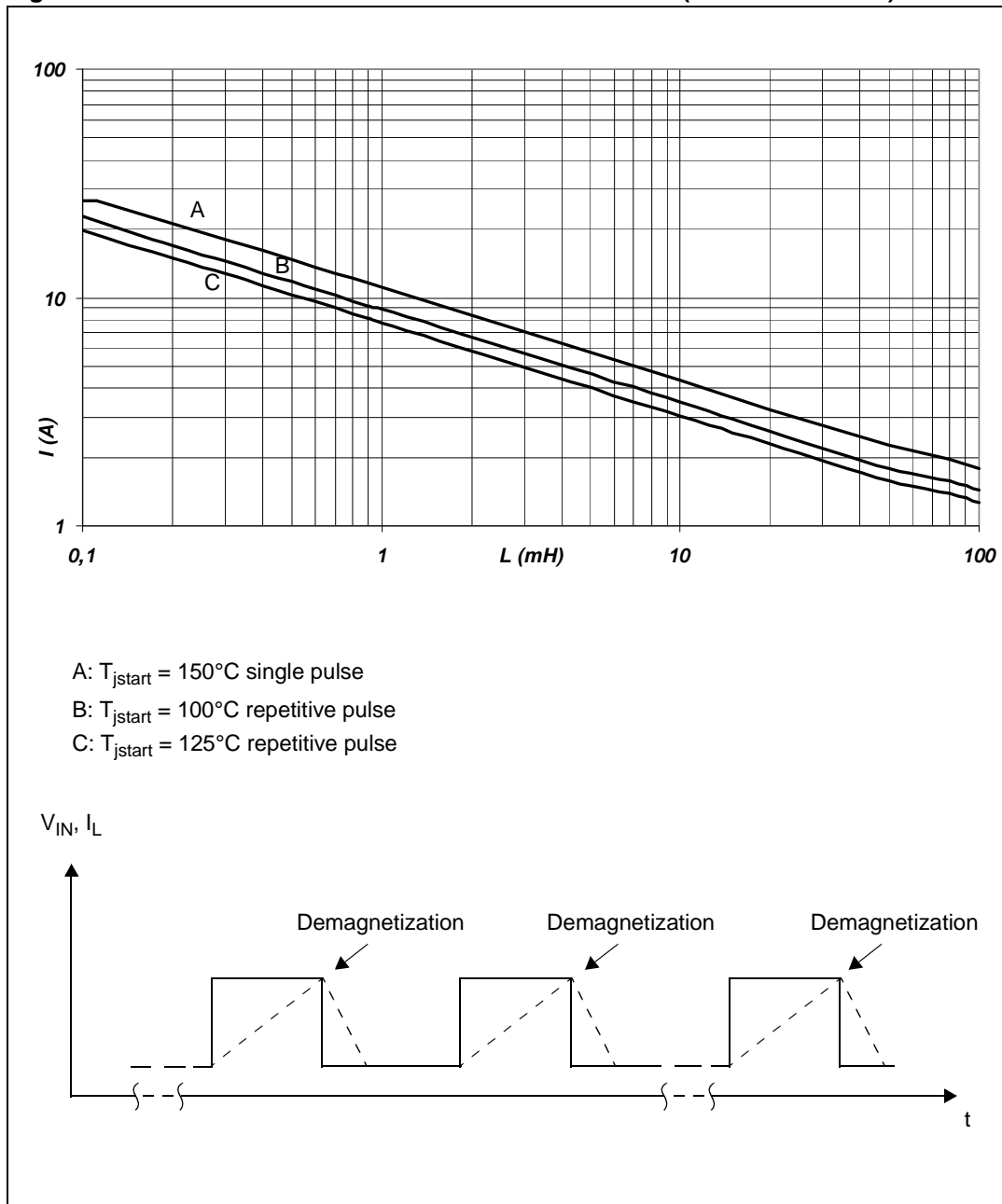

Note: Values are generated with $R_L = 0 \Omega$.
 In case of repetitive pulses, T_{jstart} (at beginning of each demagnetization) of every pulse must not exceed the temperature specified above for curves A and B.

4 Package and PC board thermal data

4.1 PowerSSO-24 thermal data

Figure 28. PowerSSO-24 PC board

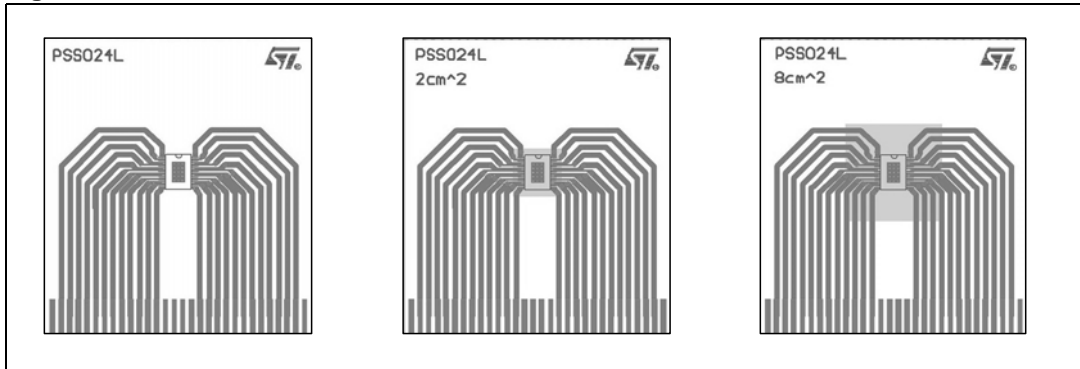

Note: Layout condition of R_{th} and Z_{th} measurements (PCB: Double layer, Thermal Vias, FR4 area= 77 mm x 86 mm, PCB thickness=1.6mm, Cu thickness=70 μ m (front and back side), Copper areas: from minimum pad lay-out to 8 cm²).

Figure 29. $R_{thj-amb}$ vs PCB copper area in open box free air condition (one channel on)

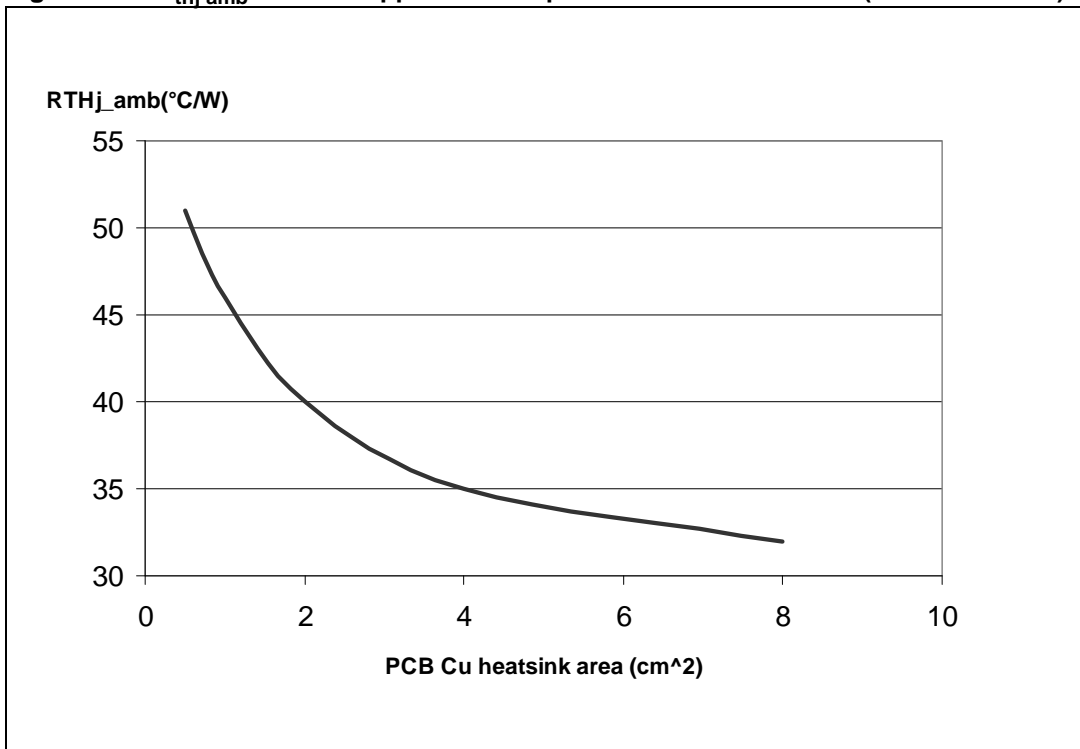

Figure 30. PowerSSO-24 thermal impedance junction ambient single pulse (one channel on)

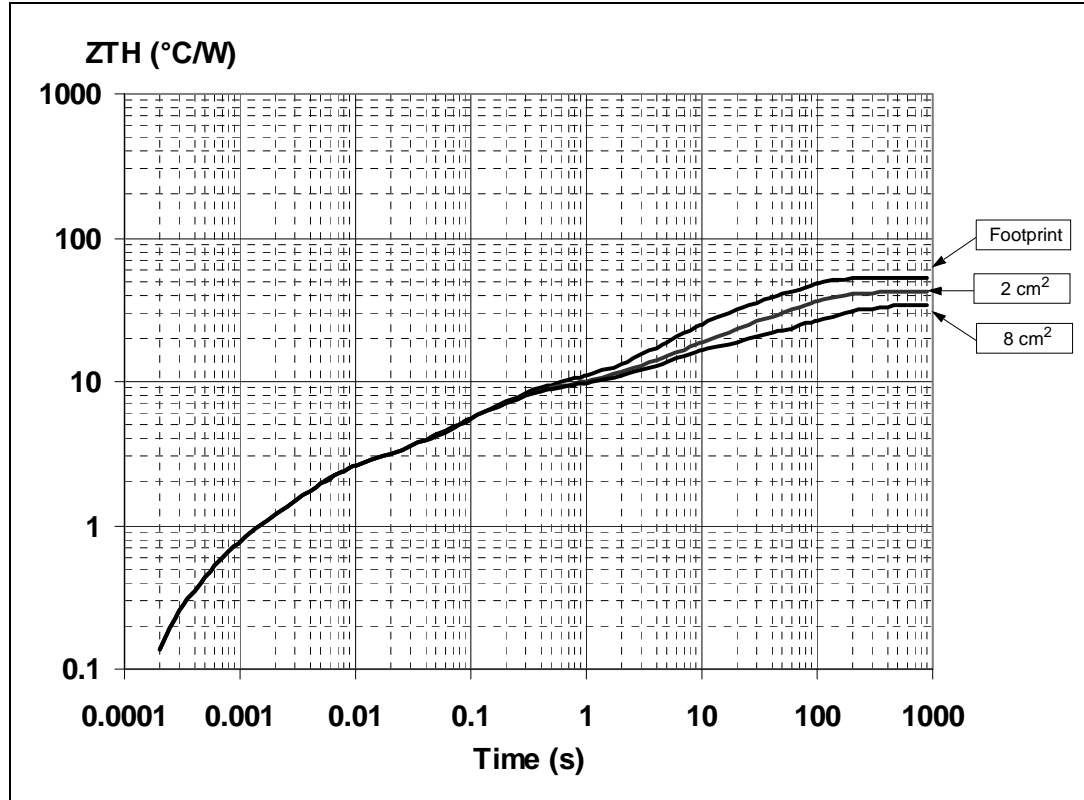
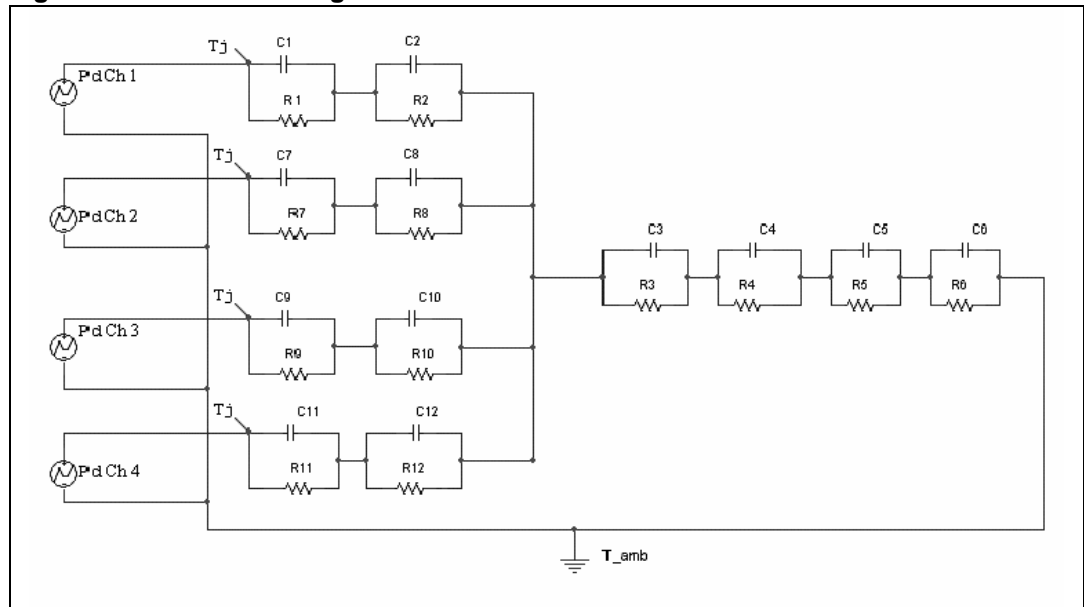

Figure 31. Thermal fitting model of a double channel HSD in PowerSSO-24^(a)



a. The fitting model is a simplified thermal tool and is valid for transient evolutions where the embedded protections (power limitation or thermal cycling during thermal shutdown) are not triggered.

Equation 1: pulse calculation formula

$$Z_{TH\delta} = R_{TH} \cdot \delta + Z_{THtp}(1 - \delta)$$

where $\delta = t_p/T$

Table 15. Thermal parameters

Area/island (cm ²)	Footprint	2	8
R1=R7=R9=R11 (°C/W)	0.4	-	-
R2=R8=R10=R12 (°C/W)	2	-	-
R3 (°C/W)	6	-	-
R4 (°C/W)	7.7	-	-
R5 (°C/W)	9	9	8
R6 (°C/W)	28	17	10
C1=C7=C9=C11 (W.s/°C)	0.001	-	-
C2=C8=C10=C12 (W.s/°C)	0.0022	-	-
C3 (W.s/°C)	0.025	-	-
C4 (W.s/°C)	0.75	-	-
C5 (W.s/°C)	1	4	9
C6 (W.s/°C)	2.2	5	17

5 Package and packing information

5.1 ECOPACK® packages

In order to meet environmental requirements, ST offers these devices in different grades of ECOPACK® packages, depending on their level of environmental compliance. ECOPACK® specifications, grade definitions and product status are available at: www.st.com.

ECOPACK® is an ST trademark.

5.2 PowerSSO-24™ mechanical data

Table 16. PowerSSO-24™ mechanical data

Symbol	Millimeters		
	Min.	Typ.	Max.
A	-	-	2.45
A2	2.15	-	2.35
a1	0	-	0.10
b	0.33	-	0.51
c	0.23	-	0.32
D	10.10	-	10.50
E	7.4	-	7.6
e	-	0.8	-
e3	-	8.8	-
G	-	-	0.1
G1	-	-	0.06
H	10.1	-	10.5
h	-	-	0.4
k	0°	-	8°
L	0.55	-	0.85
N	-	-	10°
X	4.1	-	4.7
Y	6.5	-	7.1

Figure 32. PowerSSO-24™ package dimensions

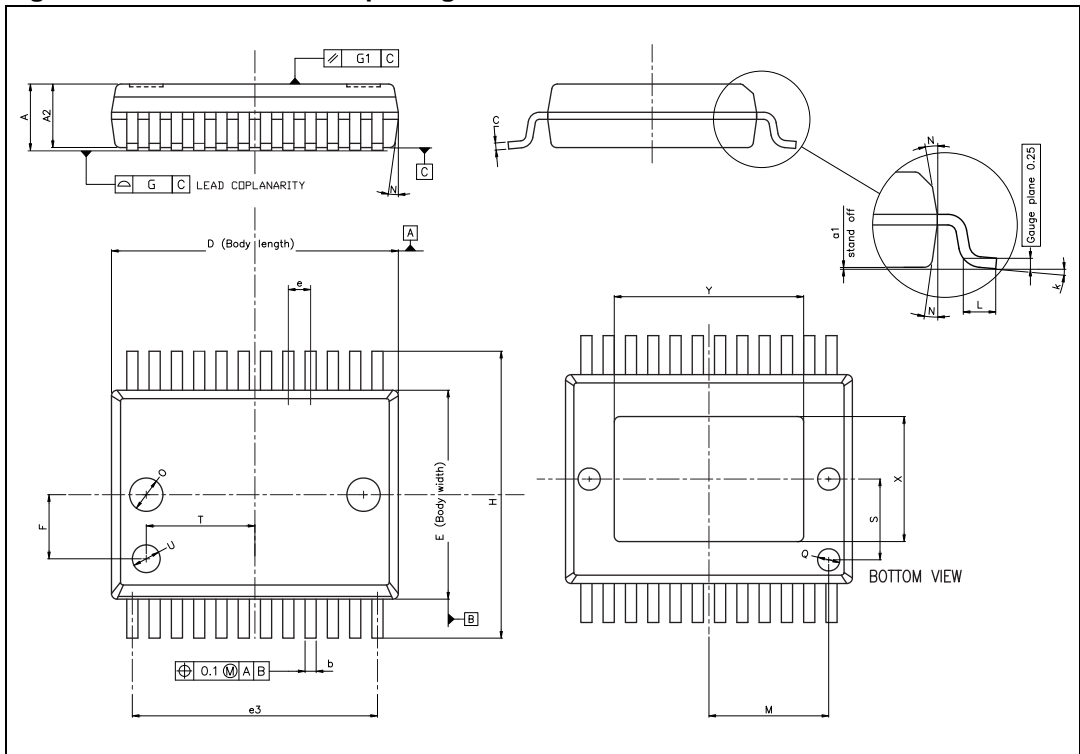

5.3 Packing information

Figure 33. PowerSSO-24 tube shipment (no suffix)

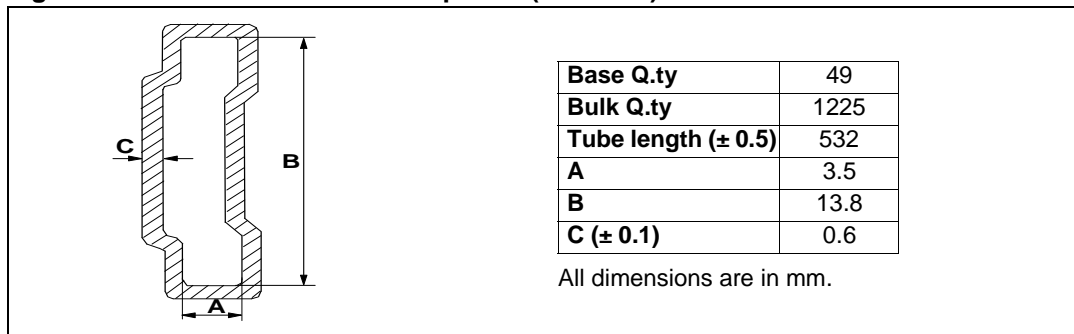
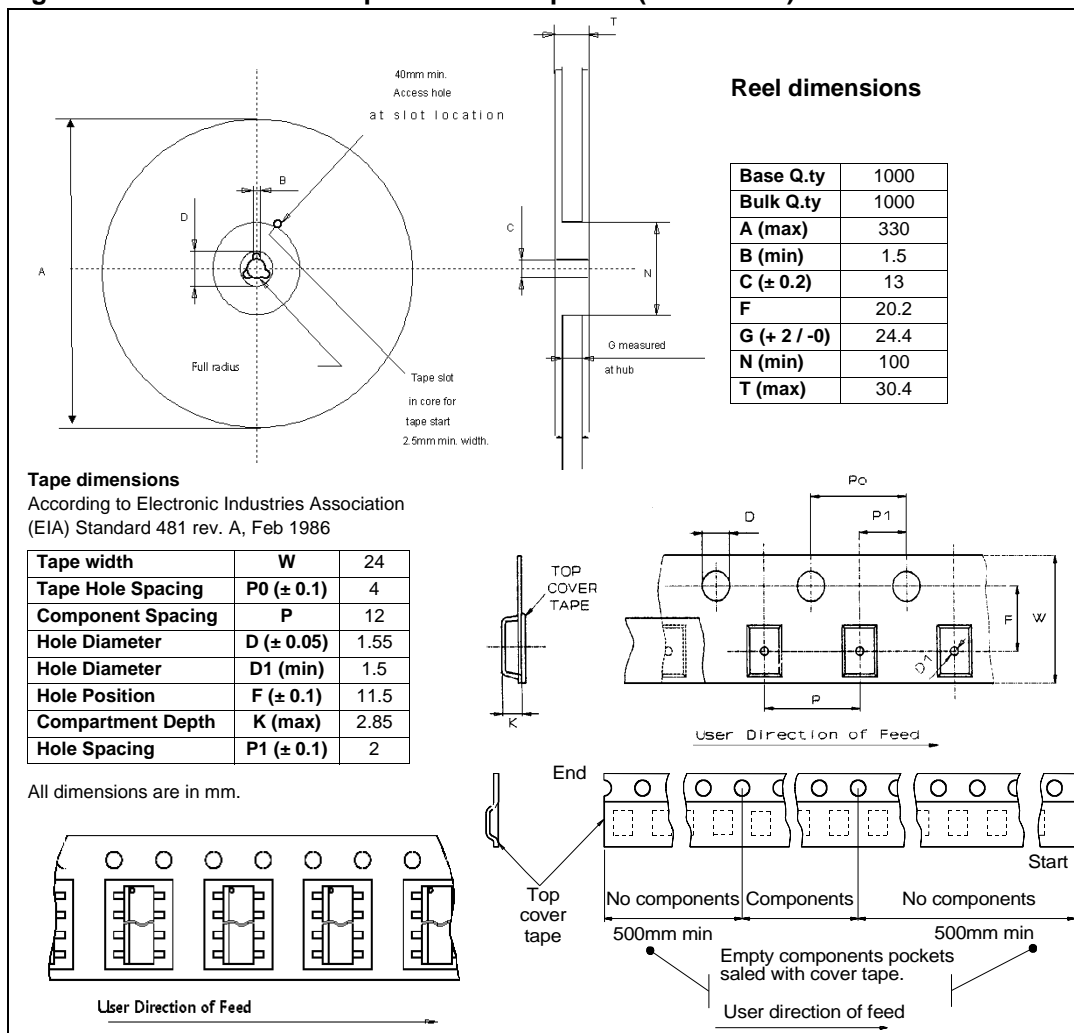

Figure 34. PowerSSO-24 tape and reel shipment (suffix “TR”)



6 Revision history

Table 17. Document revision history

Date	Revision	Changes
14-Sep-2004	1	Initial release.
12-Jan-2006	2	Major general update.
9-Mar-2007	3	Reformatted and restructured. Added contents, lists of tables and list of figures. Added Section 3.4: Maximum demagnetization energy (VCC = 13.5V) . Added ECOPACK® packages information. Added new disclaimer.
22-Aug-2007	4	Figure 14: Input high level and Figure 15: Input hysteresis voltage corrected.
01-Oct-2007	5	Table 4: Absolute maximum ratings : changed E _{MAX} value from 51 to 104 mJ. Table 8: Current sense (8V < V_{CC} < 16V) : added dk1/k1, dk2/k2, dk3/k3, Δt _{DSENSE2H} . Added Figure 5: Delay response time between rising edge of output current and rising edge of current sense (CS enabled) . Updated Figure 7: I_{OUT}/I_{SENSE} vs I_{OUT} . Added Figure 8: Maximum current sense ratio drift vs load current . Table 12: Electrical transient requirements (part 1/3) : added notes. Figure 31: Thermal fitting model of a double channel HSD in PowerSSO-24 , added note.
04-Dec-2007	6	Updated Table 8: Current sense (8V < V_{CC} < 16V) : – changed t _{DSENSE2H} max value from 300 μs to 250 μs. – added I _{OL} parameter.
12-Feb-2008	7	Corrected typing error in Table 8: Current sense (8V < V_{CC} < 16V) : changed I _{OL} test condition from V _{IN} = 0V to V _{IN} = 5V.
14-May-2009	8	Table 16: PowerSSO-24™ mechanical data : – Updated a1 (max) from 0.075 to 0.10.
29-May-2009	9	Table 16: PowerSSO-24™ mechanical data : – Updated A (min) from 2.15 to - and A (max) from 2.47 to 2.45 – Updated A2 (max) from 2.40 to 2.35 – Updated k (min) from - to 0°, k (typ) from 5° to - and k (max) from - to 8°
22-Sep-2013	10	Updated Disclaimer.

Please Read Carefully:

Information in this document is provided solely in connection with ST products. STMicroelectronics NV and its subsidiaries ("ST") reserve the right to make changes, corrections, modifications or improvements, to this document, and the products and services described herein at any time, without notice.

All ST products are sold pursuant to ST's terms and conditions of sale.

Purchasers are solely responsible for the choice, selection and use of the ST products and services described herein, and ST assumes no liability whatsoever relating to the choice, selection or use of the ST products and services described herein.

No license, express or implied, by estoppel or otherwise, to any intellectual property rights is granted under this document. If any part of this document refers to any third party products or services it shall not be deemed a license grant by ST for the use of such third party products or services, or any intellectual property contained therein or considered as a warranty covering the use in any manner whatsoever of such third party products or services or any intellectual property contained therein.

UNLESS OTHERWISE SET FORTH IN ST'S TERMS AND CONDITIONS OF SALE ST DISCLAIMS ANY EXPRESS OR IMPLIED WARRANTY WITH RESPECT TO THE USE AND/OR SALE OF ST PRODUCTS INCLUDING WITHOUT LIMITATION IMPLIED WARRANTIES OF MERCHANTABILITY, FITNESS FOR A PARTICULAR PURPOSE (AND THEIR EQUIVALENTS UNDER THE LAWS OF ANY JURISDICTION), OR INFRINGEMENT OF ANY PATENT, COPYRIGHT OR OTHER INTELLECTUAL PROPERTY RIGHT.

ST PRODUCTS ARE NOT DESIGNED OR AUTHORIZED FOR USE IN: (A) SAFETY CRITICAL APPLICATIONS SUCH AS LIFE SUPPORTING, ACTIVE IMPLANTED DEVICES OR SYSTEMS WITH PRODUCT FUNCTIONAL SAFETY REQUIREMENTS; (B) AERONAUTIC APPLICATIONS; (C) AUTOMOTIVE APPLICATIONS OR ENVIRONMENTS, AND/OR (D) AEROSPACE APPLICATIONS OR ENVIRONMENTS. WHERE ST PRODUCTS ARE NOT DESIGNED FOR SUCH USE, THE PURCHASER SHALL USE PRODUCTS AT PURCHASER'S SOLE RISK, EVEN IF ST HAS BEEN INFORMED IN WRITING OF SUCH USAGE, UNLESS A PRODUCT IS EXPRESSLY DESIGNATED BY ST AS BEING INTENDED FOR "AUTOMOTIVE, AUTOMOTIVE SAFETY OR MEDICAL" INDUSTRY DOMAINS ACCORDING TO ST PRODUCT DESIGN SPECIFICATIONS. PRODUCTS FORMALLY ESCC, QML OR JAN QUALIFIED ARE DEEMED SUITABLE FOR USE IN AEROSPACE BY THE CORRESPONDING GOVERNMENTAL AGENCY.

Resale of ST products with provisions different from the statements and/or technical features set forth in this document shall immediately void any warranty granted by ST for the ST product or service described herein and shall not create or extend in any manner whatsoever, any liability of ST.

ST and the ST logo are trademarks or registered trademarks of ST in various countries.

Information in this document supersedes and replaces all information previously supplied.

The ST logo is a registered trademark of STMicroelectronics. All other names are the property of their respective owners.

© 2013 STMicroelectronics - All rights reserved

STMicroelectronics group of companies

Australia - Belgium - Brazil - Canada - China - Czech Republic - Finland - France - Germany - Hong Kong - India - Israel - Italy - Japan - Malaysia - Malta - Morocco - Philippines - Singapore - Spain - Sweden - Switzerland - United Kingdom - United States of America

www.st.com



Стандарт Электрон Связь

Мы молодая и активно развивающаяся компания в области поставок электронных компонентов. Мы поставляем электронные компоненты отечественного и импортного производства напрямую от производителей и с крупнейших складов мира.

Благодаря сотрудничеству с мировыми поставщиками мы осуществляем комплексные и плановые поставки широчайшего спектра электронных компонентов.

Собственная эффективная логистика и склад в обеспечивает надежную поставку продукции в точно указанные сроки по всей России.

Мы осуществляем техническую поддержку нашим клиентам и предпродажную проверку качества продукции. На все поставляемые продукты мы предоставляем гарантию .

Осуществляем поставки продукции под контролем ВП МО РФ на предприятия военно-промышленного комплекса России , а также работаем в рамках 275 ФЗ с открытием отдельных счетов в уполномоченном банке. Система менеджмента качества компании соответствует требованиям ГОСТ ISO 9001.

Минимальные сроки поставки, гибкие цены, неограниченный ассортимент и индивидуальный подход к клиентам являются основой для выстраивания долгосрочного и эффективного сотрудничества с предприятиями радиоэлектронной промышленности, предприятиями ВПК и научно-исследовательскими институтами России.

С нами вы становитесь еще успешнее!

Наши контакты:

Телефон: +7 812 627 14 35

Электронная почта: sales@st-electron.ru

Адрес: 198099, Санкт-Петербург,
Промышленная ул, дом № 19, литера Н,
помещение 100-Н Офис 331