



# THERMOMARK LINE

The easy way of printing

# PHOENIX CONTACT – In dialog with customers and partners worldwide

Phoenix Contact is one of the leading manufacturers of electrical connection and industrial automation technology. Founded over 80 years ago, the company now employs 9900 people all over the world, more than 5500 of whom are based in Germany. A sales network with over 46 subsidiaries and more than 30 additional sales partners guarantees customer proximity directly on site, anywhere in the world.

The product range comprises first-class components, systems and services for a wide range of applications – the offer ranges right from modular terminal blocks to interface technology, PCB connection methods, solutions for surge protection all the way to hardware and software solutions for the automation of industrial systems.



## Global player with personal customer contact

Company independence is an integral part of our corporate policy. Phoenix Contact therefore relies on in-house competence and expertise in a range of contexts: the design and development departments constantly come up with innovative product ideas, developing special solutions to meet customer requirements. Numerous patents emphasize the fact that many products are own-grown Phoenix Contact developments.

## THERMOMARK LINE

THERMOMARK LINE from Phoenix Contact is the intelligent solution for the quick and easy labeling of terminal blocks, conductors and devices. The system comprises two different thermal transfer printers, the THERMOMARK CARD and the THERMOMARK ROLL, a high-quality notebook with pre-installed CLIP PROJECT planning and marking software and a wide range of marking materials in card, sheet and roll format.



### Table of contents

#### **THERMOMARK LINE –**

a seamless system from planning through to the finished printed application

Page 4

---

#### **THERMOMARK LINE –**

marking expertise

Page 10

---

#### **THERMOMARK CARD –**

labeling material in card and sheet format for terminal block, conductor and device marking

Page 18

---

#### **THERMOMARK ROLL –**

labeling material in roll and continuous format for terminal block, conductor and device marking

Page 26

---

#### **Marker carriers for terminal block, conductor and device marking**

Page 36

---

#### **Matrix –**

assignment of the marking material to the individual terminal blocks and devices from Phoenix Contact and other manufacturers

Page 42

---

#### **Register**

Page 64

---

# THERMOMARK LINE –

a seamless system from planning through to the finished printed application



**Software**

**Printer**



THERMOMARK LINE - software and hardware made to match for quick and easy labeling of your applications. A wide range of software-controlled terminal block, conductor and device marking materials are available for the labeling of your entire application, irrespective of which printer system you opt for.

## THERMOMARK CARD



## THERMOMARK ROLL



## Marker carriers



## Matrix

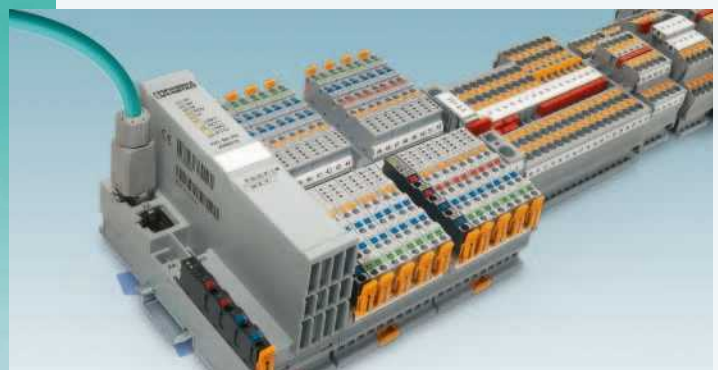

**Material**

## THERMOMARK CARD

This thermal transfer printer prints marking materials in card and sheet format. You can mark your terminal blocks, conductors and devices easily and to a high quality. The low weight and compact design of the printer also allow for mobile use on-site.



| Technical data  | Description   | Type                       | Order No.       |
|---|---|----------------------------|-----------------|
| Print resolution 300 dpi<br>Speed 8 sec/sheet<br>Interfaces USB and Ethernet<br>Power supply 100 - 240 V ~<br>50/60Hz, PFC<br>Operation Touch screen<br>Printable material Plastic sheets, UCT<br>and US format<br>Dimensions (W x H x D) 253 x 189 x 320 mm<br>Weight approx. 6 kg | <b>THERMOMARK CARD</b> , thermal transfer printer for card and sheet material, incl. Euro mains cable, US mains cable, USB cable, CLIP PROJECT advanced software, CD with multi-language usermanual, driver and firmware, DIN A5 manual German/English, magazine for UCT-TM materials, magazine for US materials, one UCT-TM 5, one US-EMP (85.6 x 54), one ink ribbon (50-meter sample roll) | THERMOMARK CARD            | <b>5146464</b>  |
|   | <b>THERMOMARK CARD SET</b> , consisting of THERMOMARK CARD and MARKING NOTEBOOK with German keyboard and the CLIP PROJECT professional software   | THERMOMARK CARD SET        | <b>5147200</b>  |
|   | <b>THERMOMARK CARD SET EN</b> , consisting of THERMOMARK CARD and MARKING NOTEBOOK with English keyboard and the CLIP PROJECT professional software   | THERMOMARK CARD SET EN     | <b>5147201</b>  |
| THERMOMARK CARD accessories   | Description   | Type                       | Order No.       |
|   | Magazine for US cards   | THERMOMARK CARD - US-MAG1  | <b>5146451</b>  |
|   | Magazine for UCT sheets [UCT-TM..., UCT1-TM..., UCT5-TM...]   | THERMOMARK CARD - UCT-MAG1 | <b>5146480</b>  |
|   | Magazine for UCT sheets [UCT-TMF...]  | THERMOMARK CARD - UCT-MAG2 | <b>5146563</b>  |
|   | Magazine for UCT sheets [UCT-WMS...]  | THERMOMARK CARD - UCT-MAG3 | <b>5146613</b>  |
|   | Magazine for UCT sheets [UCT1-TMF...]   | THERMOMARK CARD - UCT-MAG4 | <b>5146614</b>  |
|   | Magazine for UCT sheets [UCT2-TM...]  | THERMOMARK CARD - UCT-MAG5 | <b>5146615</b>  |
|   | Magazine for UCT sheets [UCT3-TM...]  | THERMOMARK CARD - UCT-MAG6 | <b>5146616</b>  |
|   | Ink ribbon, ink color: black, length 300 m, width 110 mm  | THERMOMARK-RIBBON 110-TC   | <b>080137 1</b> |
|   | Stable transport case with aluminum edges for printers and accessories  | TL CASE                    | <b>0800613</b>  |

## THERMOMARK ROLL

This thermal transfer printer has been designed for printing rolls and continuous media. You can easily create accurately printed labels, markers and shrink sleeves for terminal block, conductor and device marking. The compact printer is also suitable for mobile use.



| Technical data              |   | Description  | Type                          | Order No.      |
|-----------------------------|---|--|-------------------------------|----------------|
| Print resolution            | 300 dpi                                 | <b>THERMOMARK ROLL</b> , thermal transfer-printer for roll material, incl. Euro mains cable, US mains cable, USB cable, CLIP PROJECT advanced software, CD with multi-language user manual, driver and firmware, DIN A5 manual German/English, one roll of labels EML (20x8) with 1000 labels, one ink ribbon (50-meter sample roll) | THERMOMARK ROLL               | <b>5146477</b> |
| Interfaces                  | USB and Ethernet                        |  |                               |                |
| Power supply                | 100 - 240 V ~<br>50/60Hz, PFC           |  |                               |                |
| Operation                   | Touch screen                            |  |                               |                |
| Printable material          | Labels and shrink sleeve in roll format | <b>THERMOMARK ROLL SET</b> , consisting of THERMOMARK ROLL and MARKING NOTEBOOK with German keyboard and the CLIP PROJECT professional software  | THERMOMARK ROLL SET           | <b>5147300</b> |
| Dimensions (W x H x D)      | 253 x 189 x 320 mm                      | <b>THERMOMARK ROLL SET EN</b> , consisting of THERMOMARK ROLL and MARKING NOTEBOOK with English keyboard and the CLIP PROJECT professional software  | THERMOMARK ROLL SET EN        | <b>5147301</b> |
| Weight                      | approx. 3.5 kg                          |  |                               |                |
| THERMOMARK ROLL accessories |   | Description  | Type                          | Order No.      |
|                             |   | External media hub, for rolls of 150 to 305 mm outside diameter (RL rolls)   | THERMOMARK ROLL-ERH           | <b>5146448</b> |
|                             |   | External media hub, for rolls of up to 500 mm outside diameter (RXL rolls)   | THERMOMARK-ERH 500            | <b>5146309</b> |
|                             |   | Cutter, can be assembled later, for cutting continuous media precisely to length   | THERMOMARK ROLL-CUTTER        | <b>5146422</b> |
|                             |   | Perforation device, can be assembled later, for perforating continuous media   | THERMOMARK ROLL-CUTTER/P      | <b>5146435</b> |
|                             |   | Ink ribbon, ink color: black, length 300 m, width 110 mm   | THERMOMARK-RIBBON 110         | <b>5145384</b> |
|                             |   | Ink ribbon, ink color: blue, length 300 m, width 110 mm  | THERMOMARK-RIBBON 110 BU      | <b>0829544</b> |
|                             |   | Ink ribbon, ink color: green, length 300 m, width 110 mm   | THERMOMARK-RIBBON 110 GN      | <b>0829542</b> |
|                             |   | Ink ribbon, ink color: red, length 300 m, width 110 mm   | THERMOMARK-RIBBON 110 RD      | <b>0829543</b> |
|                             |   | Ink ribbon, ink color: black, length 300 m, width 110 mm, for high-temperature labels  | THERMOMARK-RIBBON 110-EMLHT   | <b>0800342</b> |
|                             |   | Ink ribbon for labeling shrink sleeves, ink color: black, length 300 m, width 110 mm   | THERMOMARK-RIBBON 110-WMSU    | <b>0801358</b> |
|                             |   | Ink ribbon for labeling shrink sleeves, ink color: white, length 300 m, width 110 mm   | THERMOMARK-RIBBON 110-WMSU WH | <b>0801359</b> |
|                             |   | Stable transport case with aluminum edges for printers and accessories   | TL CASE                       | <b>0800613</b> |

## CLIP PROJECT software and MARKING NOTEBOOK

### CLIP PROJECT...

The high-performance planning and marking software enables quick configuration and labeling for the control cabinet and in the field. With the click of a mouse, the software retrieves all data from electrical planning systems and automatically places the correct products and their markings in graphics and parts lists. CLIP PROJECT... supports all output devices from Phoenix Contact and, thanks to automatic Internet updates, is always up-to-date.



| Technical data                  |  | Description   | Type                      | Order No.      |
|---------------------------------|--|---|---------------------------|----------------|
| CPU                             | Pentium II > 400 MHz                     | <b>CLIP PROJECT advanced</b> , planning and marking software in German, English, French, Italian, Spanish, Russian, Polish, Hungarian, Czech, Portuguese, Chinese | CLIP PROJECT ADVANCED     | <b>5146040</b> |
| Main memory/<br>hard disk space | 128 MB/2GB                               |   |                           |                |
| Drive                           | CD-ROM                                   | Software is included in the scope of supply of the THERMOMARK CARD and THERMOMARK ROLL.   |                           |                |
| Monitor resolution              | 1024x768                                 |   |                           |                |
| Operating equipment             | Mouse recommended                        |   |                           |                |
| Operating systems               | Windows Vista<br>Windows XP<br>Windows 7 | <b>CLIP PROJECT professional</b> , extended version of CLIP PROJECT advanced with additional template designer, for designing your own marking material.          | CLIP PROJECT PROFESSIONAL | <b>5146053</b> |
|                                 |  | Software is included in the scope of supply of the MARKING BOX and is pre-installed on the MARKING Notebook.  |                           |                |



## MARKING BOX

### MARKING BOX...

This is the complete labeling system for all applications in terminal block, conductor and device marking.

The box contains the THERMOMARK CARD and THERMOMARK ROLL thermal transfer printers, plus a high-performance notebook with the CLIP PROJECT professional planning and marking software pre-installed. The system guarantees quick startup without the need for installation or configuration work (Plug'n'Print).



| Description   | Type                   | Order No. |
|---|------------------------|-----------|
| <b>MARKING BOX</b> , consisting of the THERMOMARK CARD and THERMOMARK ROLL printers, plus the MARKING NOTEBOOK with German keyboard     | MARKING BOX            | 5147100   |
| <b>MARKING BOX EN</b> , consisting of the THERMOMARK CARD and THERMOMARK ROLL printers, plus the MARKING NOTEBOOK with English keyboard | MARKING BOX EN         | 5147101   |
| <b>THERMOMARK CARD SET</b> , consisting of THERMOMARK CARD and MARKING NOTEBOOK with German keyboard                                    | THERMOMARK CARD SET    | 5147200   |
| <b>THERMOMARK CARD SET EN</b> , consisting of THERMOMARK CARD and MARKING NOTEBOOK with English keyboard                                | THERMOMARK CARD SET EN | 5147201   |
| <b>THERMOMARK ROLL SET</b> , consisting of THERMOMARK ROLL and MARKING NOTEBOOK with German keyboard                                    | THERMOMARK ROLL SET    | 5147300   |
| <b>THERMOMARK ROLL SET EN</b> , consisting of THERMOMARK ROLL and MARKING NOTEBOOK with English keyboard                                | THERMOMARK ROLL SET EN | 5147301   |

### MARKING NOTEBOOK

The notebook from the Dell Latitude TM E range transforms the new THERMOMARK printers into a complete marking system. It is characterized by reliability, a long service life and a professional design. Windows 7, CLIP PROJECT professional marking software and all of the required drivers are pre-installed and guarantee a quick startup of the entire system. Simply connect the notebook and printer via USB and you're done (Plug'n'Print).



| Technical data |                                    |  |
|----------------|------------------------------------|--|
| Processor      | One Intel®Core TM i3               | The information describes the configuration at the time of going to print. Subject to modifications in the interest of technical progress or product improvements. |
| Display        | 14" WXGA widescreen                |  |
| Hard disk      | 160 GB with 5,400 rpm (serial ATA) |  |
| Main memory    | DDR 3 with 2 GB and 1333 MHz       |  |
| Battery        | Li-ION battery with 37 Wh          |  |

# THERMOMARK LINE – marking expertise



# Test procedure for marking material in accordance with recognized standards



## Material properties

### Polyamide (PA)

Even at high operating temperatures, polyamide has excellent electrical, mechanical, chemical and thermal properties. Brief peak temperatures of up to 200°C are permissible as a result of heat aging stabilization. Polyamide absorbs moisture from its surroundings, on average 2.8%. However, this moisture is not crystallization water in the plastic itself, but chemically bonded H<sub>2</sub>O groups in the molecular structure. This makes the plastic flexible and resistant to breakage, even at temperatures as low as -60°C. PA belongs to inflammability class V2 to V0 as per UL 94. Polyamide, used by Phoenix Contact, is silicone- and halogen-free and is suitable for use in temperatures between -60°C and +125°C.

### Polycarbonate (PC)

Polycarbonate has a high mechanical strength and chemical resistance. Rigidity, dimensional stability and good heat distortion resistance are further distinguishing features of this material. Polycarbonate is used to manufacture particularly smooth and stable marking materials. Polycarbonate, used by Phoenix

Contact, absorbs little moisture, is silicone- and halogen-free and is suitable for use in temperatures between -40°C and +125°C.

### Polyvinyl chloride (PVC)

PVC has a long service life. It is characterized by its high mechanical strength and chemical resistance. Neither oxygen nor ozone affects PVC. The material is resistant to corrosive salt solutions and most acids. Polyvinyl chloride, used by Phoenix Contact, is silicone-free and is suitable for use in temperatures between -30°C and +80°C.

### Polyester

Polyester is a chemical-resistant material. It is ideally suited to printing, shaping and punching. Polyester is resistant to UV radiation and absorbs little moisture. Polyester, used by Phoenix Contact, is silicone- and halogen-free. Depending on its composition, it is suitable for use in temperatures between -40°C and +150°C.

### Polyolefins

Polyolefins are semi-crystalline thermoplastics, which can be easily processed as extrusion profiles (shrink sleeves).

They are characterized by good chemical resistance. Silicone-free, temperature range: -55°C to +125°C.

### Polyethylene (PE)

Polyethylene is a thermoplastic material which is highly resistant to acids, alkalis and other solvents. PE absorbs hardly any moisture and has a high durability and breaking elongation. Silicone- and halogen-free, temperature range: -40°C to +80°C.

### Halogen-free

The term halogen-free, based on international standards for the basic materials for PCBs (e.g. IEC 61249-2-21, IPC 4101 C), relates to the elements chlorine and bromine in flame protection agents. This also forbids the use of flame protection agents containing halogen in accordance with DIN EN ISO 1043-4. This means that, according to the definition in the ZVEI position paper (requirements for the use of halogen-free products in the electrical and electronics industry), no flame protection agents containing halogen or PVC are present in the components.

## Inflammability classification

### ► UL 94

UL 94 describes inflammability tests that have gained particular importance in the field of electrotechnology. Behavior in fire is the main focus. Items are classified according to either UL 94 HB (Horizontal Burn) or UL 94 V (Vertical Burn). The test setup is such that the 94 V0/1/2 classifications are stricter than the 94 HB classification.

#### UL 94 V0/1/2

After conditioning, the test bar is vertically clamped and flame-treated several times for 10 seconds each.

Between the flame treatments, the time until the test bar is extinguished is measured. The afterglow time and dripping properties are then assessed.

The performance of the test as per this standard is not suitable for foils and/or very thin test objects that shrink under the thermal aging of the flame.

The plastic used for Phoenix Contact products fulfills the higher-grade criteria.



#### Classification

|   | UL 94 V0 | UL 94 V1 | UL 94 V2 | UL 94 HB |
|---|----------|----------|----------|----------|
| Burning time after each flame treatment               | ≤ 10 s   | ≤ 30 s   | ≤ 30 s   | –        |
| Total burning time after 10 flame treatments          | ≤ 50 s   | ≤ 250 s  | ≤ 250 s  | –        |
| Glowing time after the 2nd flame treatment            | ≤ 30 s   | ≤ 60 s   | ≤ 60 s   | –        |
| Complete burn-off                                     | No       | No       | No       | Yes      |
| Inflammation of the absorbent cotton under the sample | No       | No       | Yes      | –        |

## Halogen-free protection against flames

### ► DIN EN ISO 1043-4

Halogens are the chemical elements astatine, fluorine, chlorine, bromine and iodine. One characteristic of the halogen compounds of bromine and chlorine relates to the reduction in the degree of inflammability when plastics are used. In the event of fire, poisonous corrosive gases are formed, which can also lead to secondary damage as a result of the extinguishing water. For this reason, Phoenix Contact does not use any flame protection agents which contain halogen or other additives. Polyamide, polycarbonate, polycarbonate/acrylnitrile butadiene styrene, acrylnitrile butadiene styrene, and polyolefins feature halogen-free flame protection systems.



## UV light resistance

### ► DIN EN ISO 4892-2 and DIN EN ISO 60068-2-5

In addition to infrared radiation, the solar radiation affecting the surface of the earth has radiation ranges from the UV-A and UV-B spectrum. Depending on the plastic used, the UV-B part of the wavelength of 320 nm induces a more or less strong molecular decomposition that is responsible for a considerable restriction of the plastic's mechanical property profile. Even the properties of printings and labelings can undergo damage to a greater or lesser extent due to this UV radiation, resulting in fading which can even lead to complete illegibility.

If plastics and their printings and labelings are often subjected to day/night cycles outdoors, condensation may appear on the surface in the form of water droplets, which can act similarly to magnifying glasses when the sunshine returns, thus intensifying the radiation effect. The UV-B part of the solar spectrum in particular

leads to an impairment of the plastic's mechanical property profile.

Marking materials from Phoenix Contact can be stored in dry as well as humid atmospheres under UV radiation and are tested in accordance with the aforementioned standards. The properties of the plastic and the legibility of the printings and labelings are checked after the test.



## Aging test

### ► IEC 60947-7-1/-2

Modular terminal blocks are characterized, among other things, by long life cycles and their ability to safely withstand continuous temperatures of +125°C. In order to ensure that the labeling of these terminal blocks also meets these requirements, Phoenix Contact uses labeling materials with heat stabilizers.

To simulate usage over several years, the marking materials are subjected to temperature cycles together with the terminal blocks or conductors in the climate cabinet. The minimum temperature in the climate cabinet is set to 20°C and the maximum temperature to 120°C (80°C with PVC). The test objects reach the maximum permissible operating temperature during the warming phase and the 10-minute pause phase. The cooling down phase follows. The test comprises a total of 192 cycles.

Phoenix Contact marking materials are, without exception, tested in accordance with IEC 60947-7-1/-2. All plastics used also have sufficient safety reserves.



Temperature in relation to time

## Resistance to oil and chemicals

### ► DIN EN ISO 175

Physical and/or chemical processes/reactions can occur as a result of external media, such as liquids or gases. This can result in a change to the plastic's properties, the plastic becoming damaged or even destroyed. The printings and labelings can also be affected by these changes.

In order to prevent this from happening, Phoenix Contact uses only plastics and printing/labeling materials which have been tested in accordance with DIN EN ISO 175.



| Chemical  | Weight % |
|---|----------|
| <b>Alkalis</b>  |          |
| Sodium hydroxide solution                                 | 3        |
| Potassium hydroxide solution                              | 3        |
| Ammonium hydroxide (ammonia water)                        | 25       |
| <b>Alcohols</b>   |          |
| Ethanol   | 100      |
| 1-propanol  | 100      |
| 2-propanol  | 100      |
| Diethylene glycol   | 100      |
| <b>Aldehyde/ketones</b>                                   |          |
| Ethyl acetate   | 100      |
| <b>Oils, greases, aliphatic and aromatic hydrocarbons</b> |          |
| IRM 902   | 100      |
| IRM 903   | 100      |
| ASTM No. 1  | 100      |
| Xylol   | 100      |
| Test benzene (180/220)                                    | 100      |
| Hycut SU 68   | 100      |
| Hycut SET 46  | 100      |
| Shell Tellus 92   | 100      |
| <b>Aqueous salt solutions</b>                             |          |
| Sodium chloride   | 5        |
| Potassium chloride  | 5        |
| Ammonium chloride (ammonia solution)                      | 100      |

## Resistance to solvents

### ► EN 60464-2:2001

Printings and labelings must be resistant to solvent vapors. Therefore, in accordance with the aforementioned standard, exposure to solvents is continued over 10 days in the following atmospheres:

- Acetone
- n-hexane
- Ethanol

The labelings and printings must still be legible after the 10-day exposure.

Phoenix Contact marking materials are solvent-resistant and fulfill the stringent requirements.



## Corrosion test

### ► DIN 50018

Extreme ambient influences impose demanding requirements on components and their labeling and marking.

The following test method, based on DIN 50018, describes the corrosion test in an alternating condensation climate with an atmosphere that contains sulphur dioxide.

Two liters of distilled water and one liter of SO<sub>2</sub> gas are introduced into a climate cabinet. During the test and at a test temperature of 40°C, an acidic atmosphere is formed, which affects the material surfaces of the test objects. After eight hours of testing, the test objects dry for 16 hours with an open door. A microscopic visual check is finally performed.

All marking materials used by Phoenix Contact comply with this demanding standard and are resistant to aggressive media.



## Salt spray

### ► IEC 60068-2-11/-52

Particularly in shipbuilding, technical components have to be marked and must remain permanently legible in corrosive atmospheres. The salt content of the air in combination with the increased humidity places high demands on the labelings and materials used. On the basis of IEC 60068-2-11/-52, it is possible to simulate the influence of a sea climate.

The resistance of the materials in a corrosive atmosphere is tested using salt spray. The test objects are placed in the test chamber and subjected to a finely dosed spray of 5% sodium chloride solution (NaCl; pH-value 6.5 - 7.2) at a temperature of +35°C for a period of 96 hours. A microscopic inspection is performed after the test. In IEC 60068-2-52, testing is also performed using 5% sodium chloride, but under conditions with different specifications.

Phoenix Contact marking materials fulfill these stringent requirements and can be used even in extreme climatic conditions.



## Scratch resistance

### ► DIN EN ISO 1518

Labelings and printings must also be resistant to external, point and/or linear mechanical loads. For this reason, Phoenix Contact tests all labelings and printings for scratch resistance in accordance with the aforementioned standard. Here a scratching tool with a hemispherical tip ( $\varnothing 1 \text{ mm}$ ) is applied to the test object with 2 - 6 N, depending on the printing procedure. A visual and microscopic inspection of the test objects is then performed.

Phoenix Contact marking materials fulfill these demanding mechanical requirements.



## Grid test

### ► DIN EN ISO 2409

A "Sellotape test" is conducted in accordance with this standard. A transparent self-adhesive tape (e.g. Sellotape) with an adhesive force of  $10 \pm 1 \text{ N}$  is applied to the labeling or printing to be tested and is then removed from the surface with an angle of  $60^\circ$  to the pull-out direction with a speed of approx. 1 cm/s.

There should be no marks from the printing on the adhesive tape after the test.

Phoenix Contact marking materials are tough and resistant to peeling.



## Adhesive strength test

### ► based on FINAT test method No. 2

The purpose of this test is to compare the adhesive strength of labels on various basic materials. To this end, a strip of labels (25 mm x 175 mm) is applied to the respective basic material with a specified force. After a defined storage period, the strip is removed from the basic material at

an angle of  $90^\circ$  and with a speed of 300 mm/min. The adhesive strength is specified in N/25 mm. The test thus enables the selection of the most suitable label for the application.

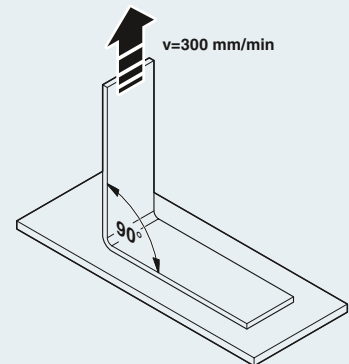



## Resistance to abrasion

### ► KIMW 003, Part 1 In-house standard of the Lüdenscheid Plastics Institute

Labelings and printings must be resistant to externally applied surface loads. Therefore at Phoenix Contact, labelings and printings are subjected to various numbers of strokes (1000, 10,000, 30,000) using a felt disk (hardness H1 as per

DIN 61200) with a specific pressure force (1 N, 2 N and/or 4 N). Classification into the various load classes presented in the standard depends on the pressure force that leads to damage to the printing with reference to the number of strokes.

The printings and labelings at Phoenix Contact fulfill the highest load class K9 (30,000 strokes with 4 N pressure force).

## Abrasion and wipe resistance

### ► DIN EN 61010-1

Labelings and printings must be resistant to the standard cleaning agents used in the industry. Therefore at Phoenix Contact, the labelings and printings are rubbed using a soft cloth with water, isopropyl alcohol, petroleum ether and n-hexane. The labelings and printings must still be legible after the test.

Phoenix Contact marking materials fulfill the stringent requirements as regards abrasion and wipe resistance and can thus be used in all applications.



## Vibration test

### ► DIN EN 61373 – Broadband noise (intensity as per DIN EN 50155)

In many applications and especially in traffic engineering, labeling materials are subjected to vibrations and shocks. For a practical simulation of the vibration stress, the test objects are tested for vibration resistance at increasing and decreasing frequencies and amplitudes. In accordance

with DIN EN 61373, the objects run through a frequency range of 5 Hz to 150 Hz during the test. The true r.m.s. value of the acceleration is up to 42.5 m/s<sup>2</sup>. The test objects are tested for five hours on each of the three axes (x, y, z). The components and marking materials must not be damaged in

such a way that would impair their continued use.

All Phoenix Contact marking materials fulfill these stringent vibration requirements.

### ► IEC 60068-2-6 – Vibration resistance

This test demonstrates the vibration resistance and the secure seating of the marking materials under the influence of continuous vibrations. Harmonic, sinusoidal vibrations are applied to the test object to simulate rotating, pulsating or oscillating forces. The test is performed on each of the three spatial axes (x, y, z). In the test, the object runs through a frequency range of 5 Hz to 150 Hz at a speed of one octave per minute. The true r.m.s. value of the acceleration is up to 50 m/s<sup>2</sup>. The test objects are tested in the three axes for two hours each. The

marking materials must not be damaged in such a way that would impair their continued use. All marking materials fulfill the requirements of the standard. They are therefore particularly suited to demanding applications in which a reliable functioning of the marking materials has to be ensured, even when subjected to vibrations.

Phoenix Contact marking materials fulfill these stringent vibration requirements.



# THERMOMARK CARD –

## The perfect printer for marking materials in card and sheet format

The THERMOMARK CARD uses the tried-and-tested thermal transfer procedure to print plastic markers in UniCard and UniSheet format.

The UniCard format is characterized by:

- simple handling
- simple separation
- simple mounting

The UniSheet format has the following advantages:

- low price
- simple separation

The comprehensive range includes markers for terminal block, conductor and device marking applications.

You can create the perfect labeling quickly and easily with the CLIP PROJECT software.



## Phoenix Contact terminal block marking for high and flat marker grooves

### UniCard UCT-TM.../UCT-TMF...

The UCT-TM... range is ideal for the quick and precise labeling of modular terminal blocks with a high marker groove. The UCT-TMF... markers can be used for modular terminal blocks with a flat marker groove. Both markers are available in all standard pitches and colors.<sup>1) 2)</sup>

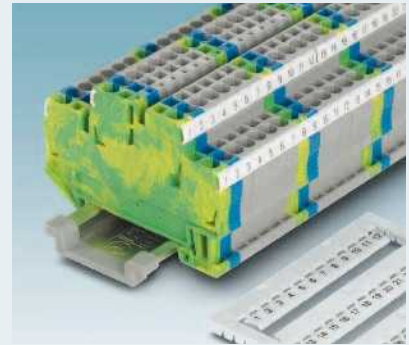
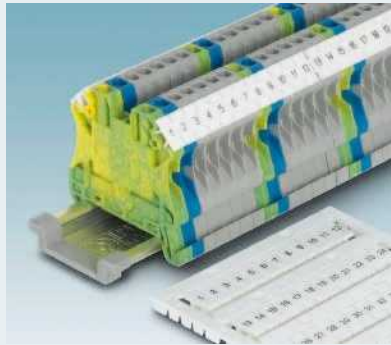

|   | Terminal block width [mm] | Markers per sheet | Pcs./Pkt. | Type        | Order No. |
|---|---------------------------|-------------------|-----------|-------------|-----------|
|   |                           |                   |           |             | WH        |
|  | 3.5                       | 102               | 10        | UCT-TM 3,5  | 0829484   |
|   | 4.2                       | 84                | 10        | UCT-TM 4    | 0828732   |
|   | 5.2                       | 72                | 10        | UCT-TM 5    | 0828734   |
|   | 6.2                       | 60                | 10        | UCT-TM 6    | 0828736   |
|   | 7.62                      | 48                | 10        | UCT-TM 7,62 | 0828738   |
|   | 8.2                       | 42                | 10        | UCT-TM 8    | 0828740   |
|   | 10.2                      | 36                | 10        | UCT-TM 10   | 0829142   |
|   | 12                        | 30                | 10        | UCT-TM 12   | 0829144   |
|   | 16                        | 18                | 10        | UCT-TM 16   | 0829146   |

| Terminal block width [mm] | Markers per sheet | Type            | Order No. |         |         |         |         |         |
|---------------------------|-------------------|-----------------|-----------|---------|---------|---------|---------|---------|
|                           |                   |                 | RD        | OG      | YE      | VT      | BU      | GN      |
| 3.5                       | 102               | UCT-TM 3,5 ...  | 0829505   | 0829506 | 0829485 | 0829507 | 0829508 | 0829509 |
| 4.2                       | 84                | UCT-TM 4 ...    | 0829149   | 0829150 | 0828733 | 0829151 | 0829152 | 0829153 |
| 5.2                       | 72                | UCT-TM 5 ...    | 0829154   | 0829155 | 0828735 | 0829156 | 0829157 | 0829158 |
| 6.2                       | 60                | UCT-TM 6 ...    | 0829159   | 0829160 | 0828737 | 0829161 | 0829162 | 0829163 |
| 7.62                      | 48                | UCT-TM 7,62 ... | 0829510   | 0829511 | 0828739 | 0829512 | 0829513 | 0829514 |
| 8.2                       | 42                | UCT-TM 8 ...    | 0829164   | 0829165 | 0828741 | 0829166 | 0829167 | 0829168 |
| 10.2                      | 36                | UCT-TM 10 ...   | 0829169   | 0829170 | 0829143 | 0829171 | 0829172 | 0829173 |
| 12                        | 30                | UCT-TM 12 ...   | 0829174   | 0829175 | 0829145 | 0829176 | 0829177 | 0829178 |
| 16                        | 18                | UCT-TM 16 ...   | 0829179   | 0829180 | 0829147 | 0829181 | 0829182 | 0829183 |

|   | Terminal block width [mm] | Markers per sheet | Pcs./Pkt. | Type        | Order No.  |
|---|---------------------------|-------------------|-----------|-------------|------------|
|   |                           |                   |           |             | WH         |
|  | 3.5                       | 108               | 10        | UCT-TMF 3,5 | 0829486    |
|   | 4.2                       | 90                | 10        | UCT-TMF 4   | 0828742    |
|   | 5.2                       | 72                | 10        | UCT-TMF 5   | 0828744    |
|   | 6.2                       | 60                | 10        | UCT-TMF 6   | 0828746    |
|   | 8.2                       | 42                | 10        | UCT-TMF 8   | 0828748    |
|   | 10.2                      | 36                | 10        | UCT-TMF 10  | 0829204    |
|   | 12                        | 30                | 10        | UCT-TMF 12  | 0829214    |
|   |                           | 16                | 18        | 10          | UCT-TMF 16 |

| Terminal block width [mm] | Markers per sheet | Type            | Order No. |         |         |         |         |         |
|---------------------------|-------------------|-----------------|-----------|---------|---------|---------|---------|---------|
|                           |                   |                 | RD        | OG      | YE      | VT      | BU      | GN      |
| 3.5                       | 108               | UCT-TMF 3.5 ... | 0829515   | 0829516 | 0829487 | 0829517 | 0829518 | 0829519 |
| 4.2                       | 90                | UCT-TMF 4 ...   | 0829184   | 0829185 | 0828743 | 0829186 | 0829187 | 0829188 |
| 5.2                       | 72                | UCT-TMF 5 ...   | 0829189   | 0829185 | 0828745 | 0829191 | 0829192 | 0829193 |
| 6.2                       | 60                | UCT-TMF 6 ...   | 0829194   | 0829195 | 0828747 | 0829196 | 0829197 | 0829198 |
| 8.2                       | 42                | UCT-TMF 8 ...   | 0829199   | 0829200 | 0828749 | 0829201 | 0829202 | 0829203 |
| 10.2                      | 36                | UCT-TMF 10 ...  | 0829205   | 0829206 | 0829207 | 0829208 | 0829209 | 0829210 |
| 12                        | 30                | UCT-TMF 12 ...  | 0829212   | 0829213 | 0829211 | 0829215 | 0829216 | 0829217 |
| 16                        | 18                | UCT-TMF 16 ...  | 0829219   | 0829220 | 0829221 | 0829222 | 0829223 | 0829224 |

<sup>1)</sup> In order to label this material you will need a suitable magazine. See page 6.

<sup>2)</sup> For the assignment of these materials to the appropriate products, see page 42 onwards.

## Phoenix Contact terminal block marking for high and flat marker grooves

### UniSheet US-TM.../US-TMF...

US-TMF 100 for the easy and low-cost labeling of modular terminal blocks with high and flat marker grooves. US-TM 100 has been specially designed for the labeling of terminal blocks with universal marker grooves, such as the PIT...<sup>1)</sup>

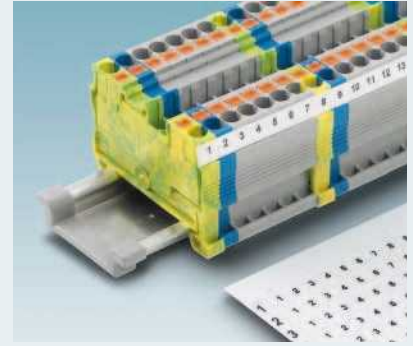
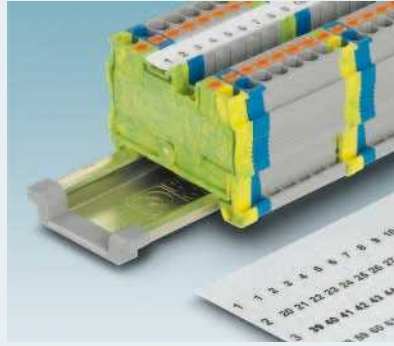

|   | Material width [mm] | Markers per card | Pcs./Pkt. | Type       | Order No.      |
|---|---------------------|------------------|-----------|------------|----------------|
|   |                     |                  |           |            | WH             |
|  | Unperforated 104    | 13               | 10        | US-TM 100  | <b>0829255</b> |
|   | Unperforated 104    | 20               | 10        | US-TMF 100 | <b>0829260</b> |

## Terminal block marking for Weidmüller/Conta Clip and Klemsan for high and flat marker grooves

### UniCard UCT1-TM.../UCT1-TMF...

UniCard markers are also available in a variety of common pitches and colors for the individual labeling of modular terminal blocks made by other manufacturers.<sup>1) 2)</sup>



|   | Terminal block width [mm] | Markers per sheet | Pcs./Pkt. | Type      | Order No.      |
|---|---------------------------|-------------------|-----------|-----------|----------------|
|   |                           |                   |           |           | WH             |
|  | 5.2                       | 72                | 10        | UCT1-TM 5 | <b>0829482</b> |
|   | 6.2                       | 60                | 10        | UCT1-TM 6 | <b>0829483</b> |

| Terminal block width [mm] | Markers per sheet | Type          | Order No.      |                |                |                |                |
|---------------------------|-------------------|---------------|----------------|----------------|----------------|----------------|----------------|
|                           |                   |               | RD             | OG             | YE             | BU             | GN             |
| 5.2                       | 72                | UCT1-TM 5 ... | <b>0829226</b> | <b>0829227</b> | <b>0829228</b> | <b>0829229</b> | <b>0829230</b> |
| 6.2                       | 60                | UCT1-TM 6 ... | <b>0829232</b> | <b>0829233</b> | <b>0829234</b> | <b>0829235</b> | <b>0829236</b> |

|   | Terminal block width [mm] | Markers per sheet | Pcs./Pkt. | Type       | Order No.      |
|---|---------------------------|-------------------|-----------|------------|----------------|
|   |                           |                   |           |            | WH             |
|  | 5.2                       | 72                | 10        | UCT1-TMF 5 | <b>0829237</b> |
|   | 6.2                       | 60                | 10        | UCT1-TMF 6 | <b>0829243</b> |

| Terminal block width [mm] | Markers per sheet | Type           | Order No.      |                |                |                |                |
|---------------------------|-------------------|----------------|----------------|----------------|----------------|----------------|----------------|
|                           |                   |                | RD             | OG             | YE             | BU             | GN             |
| 5.2                       | 72                | UCT1-TMF 5 ... | <b>0829238</b> | <b>0829239</b> | <b>0829240</b> | <b>0829241</b> | <b>0829242</b> |
| 6.2                       | 60                | UCT1-TMF 6 ... | <b>0829244</b> | <b>0829245</b> | <b>0829246</b> | <b>0829247</b> | <b>0829248</b> |

<sup>1)</sup> In order to label this material you will need a suitable magazine. See page 6.

<sup>2)</sup> For the assignment of these materials to the appropriate products, see page 49 onwards.

## Terminal block marking for Wieland/Cabur and Wago for high marker grooves

### UniCard UCT3-TM... and UCT5-TM...

UniCard markers are also available in a variety of common pitches for the individual labeling of modular terminal blocks made by other manufacturers. <sup>1) 2)</sup>



|  | Terminal block width [mm] | Markers per sheet | Pcs./Pkt. | Type      | Order No.<br>WH |
|--|---------------------------|-------------------|-----------|-----------|-----------------|
| <br>Terminal block marking, Wieland | 5                         | 72                | 10        | UCT3-TM 5 | 0829251         |
|  | 6                         | 60                | 10        | UCT3-TM 6 | 0829252         |
|  | Terminal block width [mm] | Markers per sheet | Pcs./Pkt. | Type      | Order No.<br>WH |
| <br>Terminal block marking, Cabur   | 5                         | 66                | 10        | UCT5-TM 5 | 0828750         |
|  | 6                         | 54                | 10        | UCT5-TM 6 | 0828752         |

### UniCard UCT2-TM5/6 and UniSheet US2-TM 100

UniCard and UniSheet markers are also available in a variety of pitches for the individual labeling of modular terminal blocks made by other manufacturers. <sup>1)</sup>



|   | Terminal block width [mm] | Markers per sheet | Pcs./Pkt. | Type       | Order No.<br>WH |
|---|---------------------------|-------------------|-----------|------------|-----------------|
| <br>Terminal block marking, Wago | 5.0 - 6.0                 | 72                | 10        | UCT2-TM5/6 | 0829249         |
|   | Material width [mm]       | Markers per card  | Pcs./Pkt. | Type       | Order No.<br>WH |
| <br>Terminal block marking, Wago | Unperforated 104          | 12                | 10        | US2-TM 100 | 0829268         |

<sup>1)</sup> In order to label this material you will need a suitable magazine. See page 6.

<sup>2)</sup> For the assignment of these materials to the appropriate products, see page 49 onwards.

## Conductor marking for threading and for insertion into marking collars

### UniCard UCT-WMS... and UniSheet US-WMT...

The UCT-WMS markers are simply threaded onto the conductors and held securely in place by three internal studs. The US-WMT markers have been specially designed for conductor marking with marking collars. The collars protect against environmental influences (see page 39).<sup>\*)</sup>



|   | Conductor diameter [mm] | Lettering field size [mm] | Markers per sheet | Pcs./Pkt. | Type                      | Order No. |         |
|---|-------------------------|---------------------------|-------------------|-----------|---------------------------|-----------|---------|
|   |                         |                           |                   |           |                           | WH        | YE      |
|  | 1.5 - 3.2               | 12 x 4                    | 55                | 5         | UCT-WMS 3,2 (12 x 4) ...  | 0828570   | 0828572 |
|   | 2.5 - 4.7               | 12 x 5.5                  | 45                | 5         | UCT-WMS 4,7 (12 x 5,5)... | 0828571   | 0828573 |

|  | Conductor diameter [mm]                   | Lettering field size [mm] | Markers per card | Pcs./Pkt. | Type            | Order No. |
|--|---|---------------------------|------------------|-----------|-----------------|-----------|
|  |   |                           |                  |           |                 |           |
|  | Depends on marking collars<br>See page 39 | 10 x 4                    | 112              | 10        | US-WMT (10 x 4) | 0828765   |
|  |   | 12 x 4                    | 98               | 10        | US-WMT (12 x 4) | 0828766   |
|  |   | 15 x 4                    | 84               | 10        | US-WMT (15 x 4) | 0828767   |
|  |   | 18 x 4                    | 70               | 10        | US-WMT (18 x 4) | 0828768   |
|  |   | 23 x 4                    | 56               | 10        | US-WMT (23 x 4) | 0828769   |
|  |   | 30 x 4                    | 42               | 10        | US-WMT (30 x 4) | 0828770   |

| Conductor diameter [mm]                   | Lettering field size [mm] | Type                | Order No. |         |         |         |         |         |
|---|---------------------------|---------------------|-----------|---------|---------|---------|---------|---------|
|   |                           |                     | RD        | OG      | YE      | VT      | BU      | GN      |
| Depends on marking collars<br>See page 39 | 10 x 4                    | US-WMT (10 x 4) ... | 0829273   | 0829274 | 0828952 | 0829276 | 0829277 | 0829278 |
|   | 12 x 4                    | US-WMT (12 x 4) ... | 0829280   | 0829281 | 0828953 | 0829283 | 0829284 | 0829285 |
|   | 15 x 4                    | US-WMT (15 x 4) ... | 0829287   | 0829288 | 0828954 | 0829290 | 0829291 | 0829292 |
|   | 18 x 4                    | US-WMT (18 x 4) ... | 0829294   | 0829295 | 0828955 | 0829297 | 0829298 | 0829299 |
|   | 23 x 4                    | US-WMT (23 x 4) ... | 0829301   | 0829302 | 0828956 | 0829304 | 0829305 | 0829306 |
|   | 30 x 4                    | US-WMT (30 x 4) ... | 0829308   | 0829309 | 0828957 | 0829311 | 0829312 | 0829313 |

<sup>\*)</sup> In order to label this material you will need a suitable magazine. See page 6.

## Conductor marking for cable binder mounting and with self-adhesive labels

### UniSheet US-WMTB.../US-WML...

The US-WMTB markers are ideally suited to reliable conductor marking with cable binders (see page 38). The US-WML labels are simply wound around the cables. The transparent protective foil provides support and protection against contamination and abrasion.<sup>\*)</sup>



|   | Conductor diameter [mm] | Lettering field size [mm] | Markers per card | Pcs./Pkt. | Type              | Order No.      |
|---|-------------------------|---------------------------|------------------|-----------|-------------------|----------------|
|   |                         |                           |                  |           |                   | WH             |
|  | > 4                     | 24 x 5                    | 35               | 10        | US-WMTB (24 x 5)  | <b>0828771</b> |
|   | > 6                     | 29 x 8                    | 24               | 10        | US-WMTB (29 x 8)  | <b>0828772</b> |
|   | > 6                     | 44 x 15                   | 12               | 10        | US-WMTB (44 x 15) | <b>0828773</b> |

| Conductor diameter [mm] | Lettering field size [mm] | Type                  | Order No.      |                |                |                |                |                |
|-------------------------|---------------------------|-----------------------|----------------|----------------|----------------|----------------|----------------|----------------|
|                         |                           |                       | RD             | OG             | YE             | VT             | BU             | GN             |
| > 4                     | 24 x 5                    | US-WMTB (24 x 5) ...  | <b>0829320</b> | <b>0829321</b> | <b>0828958</b> | <b>0829323</b> | <b>0829324</b> | <b>0829325</b> |
| > 6                     | 29 x 8                    | US-WMTB (29 x 8) ...  | <b>0829327</b> | <b>0829328</b> | <b>0828959</b> | <b>0829330</b> | <b>0829331</b> | <b>0829332</b> |
| > 6                     | 44 x 15                   | US-WMTB (44 x 15) ... | <b>0829334</b> | <b>0829335</b> | <b>0828960</b> | <b>0829337</b> | <b>0829338</b> | <b>0829339</b> |

|   | Conductor diameter [mm] | Lettering field size [mm] | Markers per card | Pcs./Pkt. | Type                | Order No.      |
|---|-------------------------|---------------------------|------------------|-----------|---------------------|----------------|
|   |                         |                           |                  |           |                     | WH             |
|  | < 6                     | 13 x 13                   | 32               | 10        | US-WML 6 (13 x 13)  | <b>0800472</b> |
|   | < 14                    | 25 x 19                   | 8                | 10        | US-WML 14 (25 x 19) | <b>0800473</b> |
|   | < 36                    | 25 x 25                   | 4                | 10        | US-WML 36 (25 x 25) | <b>0800474</b> |

<sup>\*)</sup> In order to label this material you will need a suitable magazine. See page 6.

## Device marking for snapping into marker carriers and for rivet or screw mounting

### UniSheet US-EMP... and US-EMSP...

The US-EMP markers are ideally suited to labeling with marker carriers (see page 38–41). The markers are mounted simply by snapping them into place. The US-EMSP markers are securely fitted by means of mounting with rivets or screws.<sup>1) 2)</sup>



|   | Lettering field size [mm] | Markers per card | Pcs./Pkt.          | Type                | Order No. |         |         |
|---|---------------------------|------------------|--------------------|---------------------|-----------|---------|---------|
|   |                           |                  |                    |                     | WH        | YE      | SR      |
|    | 17 x 15                   | 54               | 10                 | US-EMP (17 x 15)    | 0828774   | 0828774 | 0828843 |
|   | 20 x 9                    | 70               | 10                 | US-EMP (20 x 9)     | 0829439   |         |         |
|   | 25 x 6                    | 84               | 10                 | US-EMP (25 x 6)     | 0829435   |         |         |
|   | 27 x 8                    | 51               | 10                 | US-EMP (27 x 8)     | 0828775   | 0828844 | 0828845 |
|   | 27 x 12.5                 | 30               | 10                 | US-EMP (27 x 12.5)  | 0828776   | 0828846 | 0828847 |
|   | 27 x 15                   | 27               | 10                 | US-EMP (27 x 15)    | 0828777   | 0828848 | 0828849 |
|   | 27 x 18                   | 21               | 10                 | US-EMP (27 x 18)    | 0828778   | 0828850 | 0828851 |
|   | 27 x 27                   | 15               | 10                 | US-EMP (27 x 27)    | 0828779   | 0828852 | 0828853 |
|   | 29 x 8                    | 48               | 10                 | US-EMP (29 x 8)     | 0829436   | 0829440 |         |
|   | 40 x 17                   | 16               | 10                 | US-EMP (40 x 17)    | 0829437   |         |         |
|   | 44 x 7                    | 36               | 10                 | US-EMP (44 x 7)     | 0829438   |         |         |
|   | 49 x 15                   | 18               | 10                 | US-EMP (49 x 15)    | 0828780   | 0828854 | 0828854 |
|   | 60 x 15                   | 9                | 10                 | US-EMP (60 x 15)    | 0828781   | 0828856 | 0828857 |
|   | 60 x 30                   | 4                | 10                 | US-EMP (60 x 30)    | 0828782   | 0828858 | 0828859 |
| 85.6 x 54   | 2                         | 10               | US-EMP (85,6 x 54) | 0828783             | 0828860   | 0828861 |         |
| 100 x 15  | 1                         | 10               | US-EMP (100 x 15)  | 0829521             | 0829522   | 0829523 |         |
|  | 50 x 30                   | 4                | 10                 | US-EMSP (50 x 30)   | 0828786   | 0828927 | 0828928 |
|   | 75.6 x 54                 | 2                | 10                 | US-EMSP (75,6 x 54) | 0828787   | 0828929 | 0828930 |
|   | 90 x 60                   | 2                | 10                 | US-EMSP (90 x 60)   | 0828788   | 0828931 | 0828932 |

<sup>1)</sup> In order to label this material you will need a suitable magazine. See page 6.

<sup>2)</sup> For the assignment of these materials to the appropriate products, see page 61 onwards.



## UniSheet US-EMLP../US-EML... and US-EMLC

The US-EMLP markers guarantee a secure fit simply by being glued into marker carriers (see page 41). The US-EML labels are ideal for labeling without marker carriers.

The US-EMLC range can be glued over edges and curves.<sup>\*)</sup>



|           | Lettering field size [mm] | Markers per card | Pcs./Pkt.           | Type                | Order No. |         |         |
|-----------|---------------------------|------------------|---------------------|---------------------|-----------|---------|---------|
|           |                           |                  |                     |                     | WH        | YE      | SR      |
|           | 11 x 9                    | 135              | 10                  | US-EMLP (11 x 9)    | 0828789   | 0828871 | 0828872 |
|           | 15 x 5                    | 189              | 10                  | US-EMLP (15 x 5)    | 0828790   | 0828873 | 0828874 |
|           | 17 x 7                    | 108              | 10                  | US-EMLP (17 x 7)    | 0828792   | 0828877 | 0828878 |
|           | 17 x 15                   | 54               | 10                  | US-EMLP (17 x 15)   | 0828793   | 0828879 | 0828880 |
|           | 20 x 9                    | 75               | 10                  | US-EMLP (20 x 9)    | 0828795   | 0828883 | 0828884 |
|           | 22 x 22                   | 24               | 10                  | US-EMLP (22 x 22)   | 0828796   | 0828885 | 0828886 |
|           | 27 x 8                    | 51               | 10                  | US-EMLP (27 x 8)    | 0828797   | 0828889 | 0828890 |
|           | 27 x 12,5                 | 30               | 10                  | US-EMLP (27 x 12,5) | 0828798   | 0828891 | 0828892 |
|           | 27 x 15                   | 27               | 10                  | US-EMLP (27 x 15)   | 0828799   | 0828893 | 0828894 |
|           | 27 x 18                   | 21               | 10                  | US-EMLP (27 x 18)   | 0828800   | 0828895 | 0828896 |
|           | 27 x 27                   | 15               | 10                  | US-EMLP (27 x 27)   | 0828801   | 0828897 | 0828898 |
|           | 35 x 9                    | 45               | 10                  | US-EMLP (35 x 9)    | 0828802   | 0828899 | 0829430 |
|           | 49 x 15                   | 18               | 10                  | US-EMLP (49 x 15)   | 0828803   | 0828901 | 0828902 |
|           | 60 x 15                   | 9                | 10                  | US-EMLP (60 x 15)   | 0828804   | 0828903 | 0828904 |
|           | 60 x 30                   | 4                | 10                  | US-EMLP (60 x 30)   | 0828805   | 0828905 | 0828906 |
| 85,6 x 54 | 2                         | 10               | US-EMLP (85,6 x 54) | 0828806             | 0828907   | 0828908 |         |
| 100 x 60  | 2                         | 10               | US-EMLP (100 x 60)  | 0828807             | 0828909   | 0828910 |         |

|  | Lettering field size [mm] | Markers per card | Pcs./Pkt. | Type               | Order No. |         |         |
|--|---------------------------|------------------|-----------|--------------------|-----------|---------|---------|
|  |                           |                  |           |                    | WH        | YE      | SR      |
|  | <b>Polyester labels</b>   |                  |           |                    |           |         |         |
|  | 17,5 x 8                  | 80               | 10        | US-EML (17,5 x 8)  | 0800461   | 0800463 |         |
|  | 20 x 8                    | 64               | 10        | US-EML (20 x 8)    | 0800458   | 0800460 |         |
|  | 104 x 3,8                 | 34               | 10        | US-EML (104 x 3,8) | 0800464   |         |         |
|  | 104 x 140                 | 1                | 10        | US-EML (104 x 140) | 0800465   | 0800467 | 0800466 |
|  | <b>Textile labels</b>     |                  |           |                    |           |         |         |
|  | 20 x 8                    | 64               | 10        | US-EMLC (20 x 8)   | 0800468   | 0800469 |         |
|  | 40 x 8                    | 32               | 10        | US-EMLC (40 x 8)   | 0800470   | 0800471 |         |

<sup>\*)</sup> In order to label this material you will need a suitable magazine. See page 6.

# THERMOMARK ROLL –

## The perfect printer for marking materials in roll and continuous format

The THERMOMARK ROLL uses the tried-and-tested thermal transfer procedure to print labels and shrink sleeves in roll or continuous format.

The advantage of these formats is the quick and easy labeling of large quantities of the same material, with a significantly reduced need for handling.

The comprehensive range includes markers in a vast range of designs for terminal block, conductor and device marking applications.

You can create the perfect labeling with the CLIP PROJECT software.



## Phoenix Contact terminal block marking for high and flat marker grooves

### Roll material TMT..., TML... and SK...

The TMT markers are pre-perforated and are simply inserted into the marking grooves. With the TML self-adhesive marker strips, unlabeled terminal blocks can be marked quickly and the self-adhesive SK label material allows PCB terminal blocks to be labeled individually.

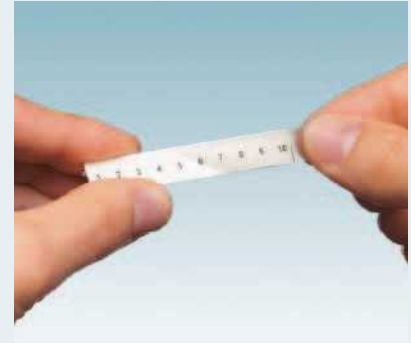

|  | Terminal block width [mm] | Markers per strip | Pcs./Pkt.       | Type      | Order No. |
|--|---------------------------|-------------------|-----------------|-----------|-----------|
|  |                           |                   |                 |           | WH        |
|  | 4.2                       | 24                | 1 <sup>1)</sup> | TMT 4 R   | 0816375   |
|  | 5.2                       | 19                | 1 <sup>1)</sup> | TMT 5 R   | 0816430   |
|  | 6.2                       | 16                | 1 <sup>1)</sup> | TMT 6 R   | 0816498   |
|  | 8.2                       | 12                | 1 <sup>1)</sup> | TMT 8 R   | 0816553   |
|  | 10.2                      | 10                | 1 <sup>1)</sup> | TMT 10 R  | 0816210   |
|  | Unperforated 101.5        | 1                 | 1 <sup>1)</sup> | TMT 100 R | 0816605   |
|  | Locking tool              |                   |                 |           | TMT TOOL  |

| Terminal block width [mm] | Markers per strip | Type          | Order No. |         |         |         |         |
|---------------------------|-------------------|---------------|-----------|---------|---------|---------|---------|
|                           |                   |               | RD        | OG      | YE      | BU      | GN      |
| 4.2                       | 24                | TMT 4 R ...   | 0816362   | 0816359 | 0816388 | 0816333 | 0816346 |
| 5.2                       | 19                | TMT 5 R ...   | 0816427   | 0816414 | 0816443 | 0816391 | 0816401 |
| 6.2                       | 16                | TMT 6 R ...   | 0816485   | 0816472 | 0816508 | 0816456 | 0816469 |
| 8.2                       | 12                | TMT 8 R ...   | 0816540   | 0816537 | 0816566 | 0816511 | 0816524 |
| 101.5                     | 1                 | TMT 100 R ... | 0816595   | 0816582 | 0816618 | 0816223 | 0816579 |

|  | Strip height [mm] | Pcs./Pkt.       | Type                 | Order No. |
|--|-------------------|-----------------|----------------------|-----------|
|  |                   |                 |                      | TR        |
|  | 4.2               | 1 <sup>2)</sup> | TML (101 x 4,2) R TR | 0816621   |
|  | 9.5               | 1 <sup>1)</sup> | TML (101 x 9,5) R TR | 0816647   |
|  | 4.2               | 1 <sup>3)</sup> | TML (E x 4,2) R TR   | 0816715   |
|  | 9.5               | 1 <sup>2)</sup> | TML (E x 9,5) R TR   | 0816634   |

|  | Strip height [mm] | Pcs./Pkt.       | Strips per roll | Type           | Order No. |
|--|-------------------|-----------------|-----------------|----------------|-----------|
|  |                   |                 |                 |                | WH        |
|  | 2.8               | 1 <sup>4)</sup> | 14              | SK 2,8 WH:REEL | 0805205   |
|  | 3.8               | 1 <sup>4)</sup> | 12              | SK 3,8 WH:REEL | 0805218   |
|  | 5                 | 1 <sup>4)</sup> | 10              | SK 5,0 WH:REEL | 0805221   |
|  | 10                | 1 <sup>4)</sup> | 6               | SK10,0 WH:REEL | 0812188   |

<sup>1)</sup> 1 roll = 1000 strips

<sup>3)</sup> 1 roll = 40 m

<sup>2)</sup> 1 roll = 2500 strips

<sup>4)</sup> 1 roll = 90 m

## Conductor marking with self-adhesive labels and for insertion into marking collars

### Roll material WML...

The conductor marker labels consist of a labeling field and a transparent protective foil. This is wound over the labeling and protects it permanently against contamination and abrasion.



|   | Conductor diameter [mm] | Lettering field size [mm] | Markers per roll | Type                | Order No.      |                |
|---|-------------------------|---------------------------|------------------|---------------------|----------------|----------------|
|   |                         |                           |                  |                     | WH             | YE             |
|  | < 3                     | 13 x 10                   | 5000             | WML 3 (13 x 10) R   | <b>0800073</b> |                |
|   | < 5                     | 25 x 10                   | 3000             | WML 5 (25 x 10) R   | <b>0817523</b> |                |
|   | < 6                     | 13 x 13                   | 7000             | WML 6 (13 x 13) R   | <b>0816252</b> |                |
|   | < 7.5                   | 13 x 13                   | 4000             | WML 7,5 (13 x 13) R | <b>0800074</b> |                |
|   | < 7.5                   | 17 x 9                    | 1500             | WML 7,5 (17 x 9) R  | <b>0828444</b> |                |
|   | < 7.5                   | 25 x 13                   | 2100             | WML 7,5 (25 x 13) R | <b>0800075</b> |                |
|   | < 12                    | 25 x 19                   | 1000             | WML 12 (25 x 19) R  | <b>0800076</b> |                |
|   | < 14                    | 25 x 19                   | 1500             | WML 14 (25 x 19) R  | <b>0817536</b> | <b>0817549</b> |
|   | < 14                    | 38 x 19                   | 1000             | WML 14 (38 x 19) R  | <b>0817552</b> |                |
|   | < 18                    | 12 x 12                   | 2500             | WML 18 (12 x 12) R  | <b>0817507</b> |                |
|   | < 20                    | 31 x 25                   | 500              | WML 20 (31 x 25) R  | <b>0828457</b> |                |
|   | < 22                    | 25 x 25                   | 900              | WML 22 (25 x 25) R  | <b>0800078</b> |                |
|   | < 36                    | 25 x 38                   | 500              | WML 36 (25 x 38) R  | <b>0817510</b> |                |
|   | < 46                    | 25 x 38                   | 250              | WML 46 (25 x 38) R  | <b>0800067</b> |                |

### Roll material EMT...

The EMT markers are used to label conductors in connection with marking collars (see page 39). The labeled markers are pushed into the appropriate marker carrier and are thus protected against environmental influences.<sup>\*)</sup>

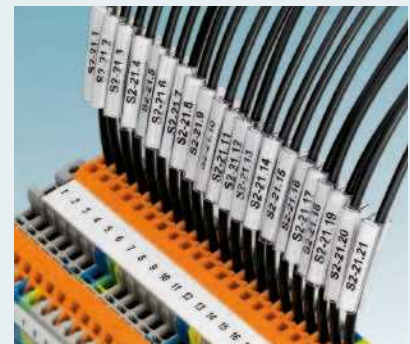

|   | Lettering field size [mm] | Markers per roll | Pcs./ Pkt. | Type            | Order No.      |                |                |                |
|---|---------------------------|------------------|------------|-----------------|----------------|----------------|----------------|----------------|
|   |                           |                  |            |                 | WH             | YE             | RD             | BU             |
|  | 10 x 4                    | 7500             | 1          | EMT (10 x 4) R  | <b>0816235</b> |                |                |                |
|   | 15 x 4                    | 7500             | 1          | EMT (15 x 4) R  | <b>0817329</b> | <b>0817358</b> | <b>0816249</b> | <b>0817332</b> |
|   | 23 x 4                    | 5000             | 1          | EMT (23 x 4) R  | <b>0817361</b> | <b>0817374</b> |                |                |
|   | 24 x 4                    | 5000             | 1          | EMT (24 x 4) R  | <b>0816265</b> |                |                |                |
|   | 25 x 6                    | 5000             | 1          | EMT (25 x 6) R  | <b>0817264</b> |                |                |                |
|   | 29 x 8                    | 5400             | 1          | EMT (29 x 8) R  | <b>0817277</b> | <b>0817280</b> |                |                |
|   | 40 x 17                   | 2300             | 1          | EMT (40 x 17) R | <b>0817293</b> |                |                |                |
|   | 44 x 7                    | 2500             | 1          | EMT (44 x 7) R  | <b>0819275</b> |                |                |                |

<sup>\*)</sup> For the assignment of this material to the appropriate products, see page 37 onwards.

## Conductor marking for threading and for cable binder mounting

### Roll material WMT...

The WMT markers, made of polyester foil, are used to label conductors. The printed individual markers are easy to slide onto the conductor and are captively mounted.



|   | Conductor diameter [mm] | Lettering field size [mm] | Markers per roll | Type                | Order No.      |
|---|-------------------------|---------------------------|------------------|---------------------|----------------|
|   |                         |                           |                  |                     | WH             |
|  | 1.0 - 2.4               | 15 x 4                    | 4000             | WMT 2.4 (15 x 4) R  | <b>0816281</b> |
|   | 2.0 - 3.5               | 15 x 5                    | 4000             | WMT 3.5 (15 x 5) R  | <b>0817222</b> |
|   | 3.0 - 4.2               | 15 x 6                    | 4000             | WMT 4.2 (15 x 6) R  | <b>0817235</b> |
|   | 4.0 - 5.5               | 15 x 8                    | 4000             | WMT 5.5 (15 x 8) R  | <b>0817248</b> |
|   | 5.0 - 8.4               | 17 x 10                   | 4000             | WMT 8.4 (17 x 10) R | <b>0817251</b> |

### Roll material WMTB...

WMTB conductor marking is ideally suited to marking and also bundling conductors in indoor areas. This marker is made of tear-free polyester foil with fixing loops and is fastened to the conductor with cable binders (see page 38).



|   | Conductor diameter [mm] | Lettering field size [mm] | Markers per roll | Pcs./Pkt. | Type             | Order No.      |
|---|-------------------------|---------------------------|------------------|-----------|------------------|----------------|
|   |                         |                           |                  |           |                  | WH             |
|  | > 6                     | 24 x 8                    | 4000             | 1         | WMTB (24 x 8) R  | <b>0816278</b> |
|   | > 6                     | 35 x 15                   | 1700             | 1         | WMTB (35 x 15) R | <b>0817316</b> |

## Conductor marking with marking/shrink sleeves

### Roll material WMS... (pre-assembled)

The shrinkable WMS... marker sleeves are ideally suited to captive cable and conductor marking. The halogen-free, perforated material can be easily separated into smaller sections. They are attached to the conductor by simply threading them on and removing them from the carrier. <sup>1) 2)</sup>



|   | Conductor diameter [mm] | Lettering field size [mm] | Markers per roll     | Type                 | Order No. |         |
|---|-------------------------|---------------------------|----------------------|----------------------|-----------|---------|
|   |                         |                           |                      |                      | WH        | YE      |
|  | 0.8 - 2.4               | 15 x 4                    | 1000                 | WMS 2,4 (15 x 4) R   | 0800379   | 0800412 |
|   | 0.8 - 2.4               | 15 x 4                    | 4000                 | WMS 2,4 (15 x 4) RL  | 0800389   |         |
|   | 0.8 - 2.4               | 15 x 4                    | 10,000               | WMS 2,4 (15 x 4) RXL | 0800396   |         |
|   | 0.8 - 2.4               | 30 x 4                    | 500                  | WMS 2,4 (30 x 4) R   | 0800373   | 0800407 |
|   | 0.8 - 2.4               | 30 x 4                    | 2000                 | WMS 2,4 (30 x 4) RL  | 0800386   |         |
|   | 0.8 - 2.4               | 30 x 4                    | 5000                 | WMS 2,4 (30 x 4) RXL | 0800394   |         |
|   | 0.8 - 2.4               | 60 x 4                    | 250                  | WMS 2,4 (60 x 4) R   | 0800363   | 0800398 |
|   | 0.8 - 2.4               | 60 x 4                    | 1000                 | WMS 2,4 (60 x 4) RL  | 0800383   |         |
|   | 0.8 - 2.4               | 60 x 4                    | 2500                 | WMS 2,4 (60 x 4) RXL | 0800392   |         |
|   | 1.0 - 3.2               | 15 x 5                    | 1000                 | WMS 3,2 (15 x 5) R   | 0800380   | 0800413 |
|   | 1.0 - 3.2               | 15 x 5                    | 4000                 | WMS 3,2 (15 x 5) RL  | 0800390   |         |
|   | 1.0 - 3.2               | 30 x 5                    | 500                  | WMS 3,2 (30 x 5) R   | 0800374   | 0800408 |
|   | 1.0 - 3.2               | 30 x 5                    | 2000                 | WMS 3,2 (30 x 5) RL  | 0800387   |         |
|   | 1.0 - 3.2               | 60 x 5                    | 250                  | WMS 3,2 (60 x 5) R   | 0800364   | 0800399 |
|   | 1.0 - 3.2               | 60 x 5                    | 1000                 | WMS 3,2 (60 x 5) RL  | 0800384   |         |
|   | 1.6 - 4.8               | 15 x 9                    | 1000                 | WMS 4,8 (15 x 9) R   | 0800382   | 0800414 |
|   | 1.6 - 4.8               | 15 x 9                    | 4000                 | WMS 4,8 (15 x 9) RL  | 0800391   |         |
|   | 1.6 - 4.8               | 15 x 9                    | 10,000               | WMS 4,8 (15 x 9) RXL | 0800397   |         |
|   | 1.6 - 4.8               | 30 x 9                    | 500                  | WMS 4,8 (30 x 9) R   | 0800375   | 0800409 |
|   | 1.6 - 4.8               | 30 x 9                    | 2000                 | WMS 4,8 (30 x 9) RL  | 0800388   |         |
|   | 1.6 - 4.8               | 30 x 9                    | 5000                 | WMS 4,8 (30 x 9) RXL | 0800395   |         |
|   | 1.6 - 4.8               | 60 x 9                    | 250                  | WMS 4,8 (60 x 9) R   | 0800366   | 0800400 |
|   | 1.6 - 4.8               | 60 x 9                    | 1000                 | WMS 4,8 (60 x 9) RL  | 0800385   |         |
|   | 1.6 - 4.8               | 60 x 9                    | 2500                 | WMS 4,8 (60 x 9) RXL | 0800393   |         |
|   | 2.1 - 6.4               | 30 x 10                   | 500                  | WMS 6,4 (30 x 10) R  | 0800376   | 0800410 |
|   | 2.1 - 6.4               | 60 x 10                   | 250                  | WMS 6,4 (60 x 10) R  | 0800367   | 0800401 |
|   | 3.1 - 9.5               | 30 x 16                   | 500                  | WMS 9,5 (30 x 16) R  | 0800377   | 0800411 |
|   | 3.1 - 9.5               | 60 x 16                   | 250                  | WMS 9,5 (60 x 16) R  | 0800368   | 0800402 |
|   | 4.2 - 12.7              | 60 x 20                   | 250                  | WMS 12,7 (60 x 20) R | 0800369   | 0800403 |
|   | 6.4 - 19.1              | 60 x 30                   | 250                  | WMS 19,1 (60 x 30) R | 0800370   | 0800404 |
| 8.5 - 25.4  | 60 x 40                 | 250                       | WMS 25,4 (60 x 40) R | 0800371              | 0800405   |         |
| 12.7 - 38.1   | 60 x 60                 | 250                       | WMS 38,1 (60 x 60) R | 0800372              | 0800406   |         |

<sup>1)</sup> For RL and RXL rolls, an external media hub is required (see page 7).

<sup>2)</sup> For the labeling of WMS material, a special ink ribbon is required (see page 7).

## Conductor marking with continuous marking/shrink sleeves

### Roll material WMS... (continuous)

The shrinkable WMS... marker sleeves are perfectly suited to captive cable and conductor marking. The halogen-free, thin-walled sleeves can be cut to any length using the perforation knife and are then easy to separate. <sup>2) 3) 4)</sup>



|  | Conductor diameter [mm] | Sleeve length [m] | Markers per roll    | Type                 | Order No. |         |         |
|--|-------------------------|-------------------|---------------------|----------------------|-----------|---------|---------|
|  |                         |                   |                     |                      | WH        | YE      | BK      |
|  | 0.8 - 2.4               | 30                | 1                   | WMS 2.4 (E x 4) R    | 0800289   | 0800300 | 0800415 |
|  | 0.8 - 2.4               | 120               | 1                   | WMS 2.4 (E x 4) RL   | 0800319   | 0800328 | 0800427 |
|  | 1.0 - 3.2               | 30                | 1                   | WMS 3.2 (E x 5) R    | 0800290   | 0800301 | 0800416 |
|  | 1.0 - 3.2               | 120               | 1                   | WMS 3.2 (E x 5) RL   | 0800320   | 0800329 | 0800428 |
|  | 1.6 - 4.8               | 30                | 1                   | WMS 4.8 (E x 8) R    | 0800291   | 0800302 | 0800418 |
|  | 1.6 - 4.8               | 120               | 1                   | WMS 4.8 (E x 8) RL   | 0800321   | 0800330 | 0800429 |
|  | 2.1 - 6.4               | 25                | 1                   | WMS 6.4 (E x 10) R   | 0800292   | 0800303 | 0800419 |
|  | 2.1 - 6.4               | 100               | 1                   | WMS 6.4 (E x 10) RL  | 0800322   | 0800331 | 0800430 |
|  | 3.1 - 9.5               | 20                | 1                   | WMS 9.5 (E x 16) R   | 0800293   | 0800304 | 0800421 |
|  | 3.1 - 9.5               | 80                | 1                   | WMS 9.5 (E x 16) RL  | 0800324   | 0800332 | 0800431 |
|  | 4.2 - 12.7              | 20                | 1                   | WMS 12.7 (E x 20) R  | 0800294   | 0800305 | 0800422 |
|  | 4.2 - 12.7              | 80                | 1                   | WMS 12.7 (E x 20) RL | 0800325   | 0800333 | 0800432 |
|  | 6.4 - 19.1              | 20                | 1                   | WMS 19.1 (E x 30) R  | 0800295   | 0800306 | 0800423 |
|  | 6.4 - 19.1              | 80                | 1                   | WMS 19.1 (E x 30) RL | 0800326   | 0800334 | 0800434 |
|  | 8.5 - 25.4              | 15                | 1                   | WMS 25.4 (E x 40) R  | 0800296   | 0800308 | 0800424 |
|  | 8.5 - 25.4              | 60                | 1                   | WMS 25.4 (E x 40) RL | 0800327   | 0800335 | 0800435 |
|  | 12.7 - 38.1             | 15                | 1                   | WMS 38.1 (E x 60) R  | 0800298   | 0800309 | 0800425 |
| 16.9 - 50.8  | 15                      | 1                 | WMS 50.8 (E x 80) R | 0800299              | 0800311   | 0800426 |         |

<sup>2)</sup> For the labeling of WMS material, a special ink ribbon is required (see page 7).

<sup>3)</sup> For all continuous marker sleeves, an external media hub with an outside diameter of up to 305 is required (see page 7).

<sup>4)</sup> For perforating and cutting the continuous material to length, a cutter is required (see page 7).

## Device marking with self-adhesive labels

### Roll material EML...

The self-adhesive EML... device markers made of high-grade polyester have been developed for the marking of operating equipment in control, system and control cabinet engineering. The device markers are characterized by their high adhesive strength and an accurate printing quality that is resistant to solvents.

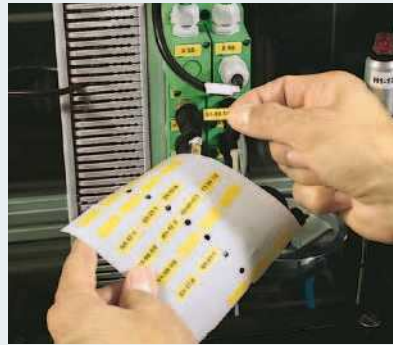

|  | Lettering field size [mm] | Markers per roll | Pcs./ Pkt. | Type                     | Order No. |         |         |         |
|--|---------------------------|------------------|------------|--------------------------|-----------|---------|---------|---------|
|  |                           |                  |            |                          | WH        | YE      | SR      | TR      |
|  | 10 x 4                    | 10,000           | 1          | EML (10 x 4) R           | 0815583   |         |         |         |
|  | 10 x 7                    | 10,000           | 1          | EML (10 x 7) R ...       | 0816663   | 0816676 |         |         |
|  | 15 x 6                    | 2500             | 1          | EML (15 x 6) R YE        |           | 0819288 |         |         |
|  | 15 x 9                    | 2500             | 1          | EML (15 x 9) R ...       | 0815677   | 0816045 | 0816032 |         |
|  | 16,5 x 5                  | 2500             | 1          | EML (16,5 x 5) R ...     | 0816702   | 0816728 |         |         |
|  | 16,5 x 5                  | 10,000           | 1          | EML (16,5 x 5) RL        | 0816113   | 0816126 |         |         |
|  | 16 x 7                    | 2500             | 1          | EML (16 x 7) R ...       | 0818001   | 0816731 |         |         |
|  | 17,5 x 8                  | 2500             | 1          | EML (17,5 x 8) R ...     | 0816744   | 0816757 |         |         |
|  | 17,5 x 8                  | 10,000           | 1          | EML (17,5 x 8) RL        |           | 0816139 |         |         |
|  | 18 x 6                    | 10,000           | 1          | EML (18 x 6) RL YE       |           | 0828460 |         |         |
|  | 19 x 6                    | 2500             | 1          | EML (19 x 6) R           | 0816760   |         |         |         |
|  | 20 x 7                    | 2500             | 1          | EML (20 x 7) R YE        |           | 0816773 |         |         |
|  | 20 x 8                    | 2500             | 1          | EML (20 x 8) R...        | 0816786   | 0816799 |         |         |
|  | 21,5 x 21,5               | 2500             | 1          | EML (21,5 x 21,5) R SR   |           |         | 0816812 |         |
|  | 24 x 4                    | 2500             | 1          | EML (24 x 4) R           | 0800061   |         |         |         |
|  | 25,4 x 12,7               | 2500             | 1          | EML (25,4 x 12,7) R ...  | 0816825   | 0816838 |         |         |
|  | 25,4 x 12,7               | 10,000           | 1          | EML (25,4 x 12,7) RL     | 0816087   |         |         |         |
|  | 26,5 x 7,5                | 1000             | 1          | EML (26,5 x 7,5) R ...   |           |         | 0816841 |         |
|  | 26,5 x 12                 | 2500             | 1          | EML (26,5 x 12) R ...    |           |         | 0816854 |         |
|  | 26,5 x 17,5               | 2500             | 1          | EML (26,5 x 17,5) R ...  |           | 0816896 | 0816883 |         |
|  | 26,5 x 18,5               | 2500             | 1          | EML (26,5 x 18,5) R ...  |           |         | 0816906 |         |
|  | 26,5 x 26,5               | 2500             | 1          | EML (26,5 x 26,5) R ...  |           |         | 0816919 |         |
|  | 30 x 20                   | 2500             | 1          | EML (30 x 20) R ...      | 0816922   | 0816935 |         |         |
|  | 32 x 25                   | 1500             | 1          | EML (32 x 25) R YE       |           | 0800020 |         |         |
|  | 38 x 17                   | 2500             | 1          | EML (38 x 17) R          | 0816951   |         |         |         |
|  | 38,1 x 19                 | 10,000           | 1          | EML (38,1 x 19) RL       | 0816171   |         |         |         |
|  | 40 x 8                    | 1000             | 1          | EML (40 x 8) R           | 0816980   |         |         |         |
|  | 40 x 15                   | 2500             | 1          | EML (40 x 15) R SR       |           |         | 0815729 |         |
|  | 40 x 25                   | 1000             | 1          | EML (40 x 25) R ...      | 0818027   | 0816977 |         |         |
|  | 50,8 x 25,4               | 3000             | 1          | EML (50,8 x 25,4) RL     | 0816184   |         |         |         |
|  | 51 x 12,5                 | 1000             | 1          | EML (51 x 12,5) R TR     |           |         |         | 0815745 |
|  | 51 x 25                   | 1000             | 1          | EML (51 x 25) R ...      | 0817028   | 0817031 | 0817002 |         |
|  | 69,8 x 31,8               | 10,000           | 1          | EML (69,8 x 31,8) RL     | 0816197   |         |         |         |
|  | 70 x 32                   | 1000             | 1          | EML (70 x 32) R ...      | 0817060   | 0817073 | 0817057 |         |
|  | 70 x 50                   | 400              | 1          | EML (70 x 50) R ...      | 0817099   |         | 0817086 |         |
|  | 76,2 x 6,5                | 10,000           | 1          | EML (76,2 x 6,5) RL YE   |           | 0816207 |         |         |
|  | 90 x 5                    | 2500             | 1          | EML (90 x 5) R           | 0817109   |         |         |         |
|  | 100 x 40                  | 300              | 1          | EML (100 x 40) R         | 0800286   |         |         |         |
|  | 100 x 73                  | 300              | 1          | EML (100 x 73) R ...     | 0817125   | 0817138 | 0817112 |         |
|  | 100 x 90                  | 250              | 1          | EML (100 x 90) R ...     | 0817154   |         | 0817141 |         |
|  | 101,6 x 25,4              | 10,000           | 1          | EML (101,6 x 25,4) RL SR |           |         | 0815790 |         |



## Device marking with self-adhesive labels

### Roll material EML...

The self-adhesive EMLHT markers have been specially developed for high temperatures and can be used continuously under temperatures ranging from  $-40^{\circ}\text{C}$  to  $180^{\circ}\text{C}$ , and up to  $300^{\circ}\text{C}$  for 60 seconds. The textile EMLC makes gluing over edges possible. The particularly flexible EMLF material is ideal for uneven surfaces.



| Lettering field size [mm]   | Markers per roll | Pcs./ Pkt.      | Type                    | Order No.      |                |                |                |
|---|------------------|-----------------|-------------------------|----------------|----------------|----------------|----------------|
|   |                  |                 |                         | WH             | YE             | SR             | TR             |
| <b>High-temperature labels</b>  |                  |                 |                         |                |                |                |                |
| 8 x 8   | 4000             | 1               | EMLHT (8 x 8) R         | <b>0800340</b> |                |                |                |
| 15 x 15   | 4000             | 1               | EMLHT (15 x 15) R       | <b>0800341</b> |                |                |                |
| 40 x 15   | 1000             | 1               | EMLHT (40 x 15) R       | <b>0800339</b> |                |                |                |
| 45 x 5  | 2500             | 1               | EMLHT (45 x 5) R        | <b>0800337</b> |                |                |                |
| 50 x 10   | 1000             | 1               | EMLHT (50 x 10) R       | <b>0800338</b> |                |                |                |
| Ø 12  | 1000             | 1               | EMLHT (D12) R           | <b>0801376</b> |                |                |                |
| For high-temperature labels, the EMLHT ink ribbon is required. See page 7 |                  |                 |                         |                |                |                |                |
| <b>Textile labels</b>   |                  |                 |                         |                |                |                |                |
| 15 x 9  | 2500             | 1               | EMLC (15 x 9) R YE      |                | <b>0800236</b> |                |                |
| 17.5 x 8  | 2500             | 1               | EMLC (17.5 x 8) R YE    |                | <b>0800237</b> |                |                |
| 20 x 8  | 2500             | 1               | EMLC (20 x 8) R YE      |                | <b>0800235</b> |                |                |
| 25 x 8  | 2500             | 1               | EMLC (25 x 8) R YE      |                | <b>0800240</b> |                |                |
| 25.4 x 12.7   | 2500             | 1               | EMLC (25.4 x 12.7) R YE |                | <b>0800238</b> |                |                |
| 38 x 17   | 1000             | 1               | EMLC (38 x 17) R YE     |                | <b>0800557</b> |                |                |
| 40 x 8  | 1000             | 1               | EMLC (40 x 8) R ...     | <b>0800554</b> | <b>0800555</b> |                |                |
| 51 x 25   | 750              | 1               | EMLC (51 x 25) R YE     |                | <b>0800558</b> |                |                |
| <b>Flexible PVC labels</b>  |                  |                 |                         |                |                |                |                |
| 108 x E   | 1                | 2 <sup>2)</sup> | EMLF (108 x E) R ...    | <b>0800549</b> | <b>0800550</b> | <b>0800551</b> | <b>0800552</b> |
| <b>Continuous polyester labels</b>  |                  |                 |                         |                |                |                |                |
| 37 x E  | 1                | 1 <sup>1)</sup> | EML (37 x E) R TR       |                |                |                | <b>0815716</b> |
| 100 x E   | 1                | 1 <sup>1)</sup> | EML (100 x E) RL SR     |                |                | <b>0815787</b> |                |
| <b>Round polyester labels</b>   |                  |                 |                         |                |                |                |                |
| Ø 17.5  | 2500             | 1               | EML (D17.5) R           | <b>0815774</b> |                |                |                |

<sup>1)</sup> 1 roll = 90 m

<sup>2)</sup> 1 roll = 40 m

## Device marking with self-adhesive labels

### Roll material EMLP...

The self-adhesive EMLP labels have a high-quality appearance and a high resistance to chemical and mechanical influences. The markers are used to label components, devices and buttons.<sup>\*)</sup>



|   | Lettering field size [mm] | Markers per roll | Pcs./ Pkt.       | Type                  | Order No.      |                |
|---|---------------------------|------------------|------------------|-----------------------|----------------|----------------|
|   |                           |                  |                  |                       | WH             | SR             |
|  | 13 x 9                    | 500              | 1                | EMLP (13 x 9) R       | <b>0819453</b> |                |
|   | 17.5 x 12                 | 500              | 1                | EMLP (17,5 x 12) R    | <b>0819466</b> |                |
|   | 17 x 7                    | 500              | 1                | EMLP (17 x 7) R       | <b>0826844</b> |                |
|   | 20 x 7                    | 500              | 1                | EMLP (20 x 7) R       | <b>0819479</b> |                |
|   | 20 x 8                    | 500              | 1                | EMLP (20 x 8) R       | <b>0819482</b> |                |
|   | 22 x 12                   | 500              | 1                | EMLP (22 x 12) R      | <b>0819495</b> |                |
|   | 22 x 22                   | 500              | 1                | EMLP (22 x 22) R SR   |                | <b>0825528</b> |
|   | 27 x 8                    | 500              | 1                | EMLP (27 x 8) R SR    |                | <b>0819518</b> |
|   | 27 x 12.5                 | 500              | 1                | EMLP (27 x 12,5) R SR |                | <b>0819521</b> |
|   | 27 x 18                   | 500              | 1                | EMLP (27 x 18) R SR   |                | <b>0819534</b> |
|   | 27 x 27                   | 500              | 1                | EMLP (27 x 27) R SR   |                | <b>0827467</b> |
|   | 45 x 15                   | 500              | 1                | EMLP (45 x 15) R SR   |                | <b>0819547</b> |
| 60 x 30   | 250                       | 1                | EMLP (60 x 30) R | <b>0817510</b>        |                |                |

|   | Lettering field size [mm] | Markers per roll | Pcs./ Pkt. | Type                    | Order No.      |                |
|---|---------------------------|------------------|------------|-------------------------|----------------|----------------|
|   |                           |                  |            |                         | WH             | SR             |
|  | 30 x 12                   | 500              | 1          | EMLP 24 (30 x 12) R ... | <b>0819550</b> | <b>0819563</b> |

<sup>\*)</sup> For the assignment of these materials to the appropriate products, see page 62.

## Device marking with self-adhesive safety labels and for snapping in

### Roll material EMLS...

When this tamper-proof label is detached (can be used, e.g., as a rating plate or security label), a part of the metal-plated layer is also detached and leaves a triangular pattern on the label and the background.



|   | Lettering field size [mm] | Markers per roll | Pcs./Pkt.           | Type                  | Order No.      |  |  |
|---|---------------------------|------------------|---------------------|-----------------------|----------------|--|--|
|   |                           |                  |                     |                       | SR             |  |  |
|  | 15 x 9                    | 2500             | 1                   | EMLS (15 x 9) R SR    | <b>0800347</b> |  |  |
|   | 19 x 6                    | 2500             | 1                   | EMLS (19 x 6) R SR    | <b>0800343</b> |  |  |
|   | 20 x 20                   | 1000             | 1                   | EMLS (20 x 20) R SR   | <b>0800344</b> |  |  |
|   | 26.5 x 12                 | 1000             | 1                   | EMLS (26.5 x 12) R SR | <b>0800353</b> |  |  |
|   | 38.1 x 19                 | 1000             | 1                   | EMLS (38.1 x 19) R SR | <b>0800354</b> |  |  |
|   | 40 x 8                    | 1000             | 1                   | EMLS (40 x 8) R SR    | <b>0800348</b> |  |  |
|   | 45 x 15                   | 1000             | 1                   | EMLS (45 x 15) R SR   | <b>0800345</b> |  |  |
|   | 60 x 30                   | 500              | 1                   | EMLS (60 x 30) R SR   | <b>0800355</b> |  |  |
|   | 70 x 32                   | 500              | 1                   | EMLS (70 x 32) R SR   | <b>0800346</b> |  |  |
|   | 70 x 150                  | 100              | 1                   | EMLS (70 x 150) R SR  | <b>0800351</b> |  |  |
| 76 x 51   | 250                       | 1                | EMLS (76 x 51) R SR | <b>0800350</b>        |                |  |  |
| 85 x 32   | 250                       | 1                | EMLS (85 x 32) R SR | <b>0800356</b>        |                |  |  |

### Roll material EMT...

A range of EMT markers in various sizes and colors is available for the labeling of controllers and modules, including those from other manufacturers.\*)



|   | Lettering field size [mm] | Markers per roll | Pcs./Pkt. | Type                   | Order No.      |                |                |
|---|---------------------------|------------------|-----------|------------------------|----------------|----------------|----------------|
|   |                           |                  |           |                        | WH             | YE             | TQ             |
|  | 50 x 13                   | 500              | 1         | EMT (50/28 x 13) R ... | <b>0800049</b> | <b>0800438</b> | <b>0800050</b> |
|   | 50 x 26                   | 500              | 1         | EMT (50 x 26) R ...    | <b>0800052</b> | <b>0800054</b> | <b>0800053</b> |
|   | 62 x 10                   | 500              | 1         | EMT (62 x 10) R ...    | <b>0800057</b> | <b>0800477</b> |                |
|   | 62 x 46                   | 250              | 1         | EMT (62 x 46) R ...    | <b>0800059</b> | <b>0800478</b> |                |
|   | 103 x 17                  | 500              | 1         | EMT (103 x 17) R ...   | <b>0800039</b> | <b>0800436</b> | <b>0800041</b> |
|   | 103 x 23                  | 500              | 1         | EMT (103 x 23) R ...   | <b>0800040</b> | <b>0800437</b> | <b>0800437</b> |

\*) For the assignment of this material to the appropriate products, see page 60 onwards.

## Shock protection labels and covers

### Transparent covers EMLPR... and EMPPR...

The very thick yet flexible EMLPR... shock protection is simply bonded over the labeled markers and provides a high degree of protection against chemical and mechanical influences. The EMPPR... range has the same function, but these are snapped over the labels into the CARRIERS provided.



|  | Cover size [mm] | Foils per card | Type                | Order No.      |
|--|-----------------|----------------|---------------------|----------------|
|  | 26.5 x 14.5     | 51             | EMLPR (26,5 x 14,5) | <b>0800546</b> |
|  | 26.5 x 17.5     | 42             | EMLPR (26,5 x 17,5) | <b>0800360</b> |
|  | 26.5 x 26.5     | 30             | EMLPR (26,5 x 26,5) | <b>0800361</b> |
|  | 30 x 40         | 14             | EMLPR (30 x 40)     | <b>0800359</b> |
|  | 80 x 42         | 6              | EMLPR (80 x 42)     | <b>0800357</b> |
|  | 80 x 60         | 4              | EMLPR (80 x 60)     | <b>0800358</b> |
|  | 100 x 30        | 9              | EMLPR (100 x 30)    | <b>0800362</b> |

|  | Cover size [mm] | For marker carriers                        | Type            | Order No.      |
|--|-----------------|--|-----------------|----------------|
|  | 27 x 15         | CARRIER-EMP 22<br>(27 x 15)<br>See page 41 | EMPPR (27 x 15) | <b>0829535</b> |
|  | 27 x 18         | CARRIER-EMP 22<br>(27 x 18)<br>See page 41 | EMPPR (27 x 18) | <b>0829536</b> |

## Marker carriers for terminal marking

### Marker carriers STP...

The marker carriers help in the labeling of wired multi-level terminal blocks. Depending on the design, the carriers are either plugged into the sockets of the upper terminal level or are snapped into the uppermost marking groove where available.



|   | Terminal block width [mm] | Type       | Order No.      | Pcs./Pkt. | Can be labeled with type | Order No.      |
|---|---------------------------|------------|----------------|-----------|--------------------------|----------------|
| <p>STP 3,5-2<br/>STP 4-2<br/>STP 5-2</p> <p>STP 3,5-3<br/>STP 5-3</p> <p>STP 5-2/S</p> <p>STP 4-2-ZB<br/>STP 5-2-ZB</p> | > 3.5                     | STP 3,5-2  | <b>0830131</b> | 100       | UCT-TM 3,5               | <b>0829484</b> |
|   | > 3.5                     | STP 3,5-3  | <b>0830132</b> | 100       | UCT-TM 3,5               | <b>0829484</b> |
|   | > 4                       | STP 4-2    | <b>0810575</b> | 100       | UCT-TM 4                 | <b>0828732</b> |
|   | > 5                       | STP 5-2    | <b>0800967</b> | 100       | UCT-TM 5                 | <b>0828734</b> |
|   | > 5                       | STP 5-3    | <b>0810562</b> | 100       | UCT-TM 5                 | <b>0828734</b> |
|   | > 5                       | STP 5-2/S  | <b>0800970</b> | 100       | UCT-TM 5                 | <b>0828734</b> |
|   | > 4                       | STP 4-2-ZB | <b>3038613</b> | 100       | UCT-TM 4                 | <b>0828732</b> |
|   | > 5                       | STP 5-2-ZB | <b>3037643</b> | 100       | UCT-TM 5                 | <b>0828734</b> |

### Terminal block group marking

Terminal block groups are marked using marking labels that are snapped into the high marker groove of the terminal blocks. The foot of the marking labels is designed in such a way that the actual terminal point labeling is thoroughly retained.



|                                      | Type          | Order No.      | Pcs./Pkt. | Can be labeled with type | Order No.      |
|--------------------------------------|---------------|----------------|-----------|--------------------------|----------------|
| <p>GBS 5-25 x 5    GBS 5-25 x 12</p> | GBS 5-25 x 5  | <b>0829126</b> | 100       | UCT-TM 5                 | <b>0828734</b> |
|                                      |               |                |           | UCT-TM 6                 | <b>0828736</b> |
| <p>GBS 5-25 x 12</p>                 | GBS 5-25 x 12 | <b>0810588</b> | 100       | UCT-TM 5                 | <b>0828734</b> |
|                                      |               |                |           | UCT-TM 6                 | <b>0828736</b> |
| <p>GBS-ZB/26 x 6</p>                 | GBS-ZB/26 x 6 | <b>0809298</b> | 100       | EML (24 x 4)R            | <b>0800061</b> |
|                                      |               |                |           | EML (25,4 x 12,7) R      | <b>0816825</b> |
| <p>AK-DST/UK    AK-DST/DIK</p>       | AK-DST/UK     | <b>1000708</b> | 50        | UCT-TM...                |                |
|                                      |               |                |           | EMT (25 x 6) R           | <b>0817264</b> |
| <p>AK-DST/UK    AK-DST/DIK</p>       | AK-DST/UK     | <b>1000708</b> | 50        | US-EMP (25 x 6)          | <b>0829435</b> |
|                                      |               |                |           | EMT (24 x 4) R           | <b>0816265</b> |
| <p>UBE</p>                           | AK-DST/DIK    | <b>1000779</b> | 50        | UCT-TM 5                 | <b>0828734</b> |
|                                      |               |                |           | EMT (24 x 4) R           | <b>0816265</b> |
| <p>UBE    UBE/D</p>                  | UBE           | <b>0800310</b> | 10        | US-EMP (40 x 17)         | <b>0829437</b> |
|                                      |               |                |           | EMT (40 x 17) R          | <b>0817293</b> |
| <p>UBE    UBE/D</p>                  | UBE/D         | <b>0800307</b> | 10        | US-EMP (40 x 17)         | <b>0829437</b> |
|                                      |               |                |           | EMT (40 x 17) R          | <b>0817293</b> |

## Marker carriers for terminal strip marking

### Terminal strip marking KLM

Terminal strip markers are used for labeling both groups and partitions. The markers can be mounted on various end brackets.



|  | Type  | Pcs./Pkt. | Order No.      | Can be labeled with type | Order No.      |
|--|---|-----------|----------------|--------------------------|----------------|
|  | KLM (for end brackets CLIPFIX 35 and E/UK)              | 100       | <b>1004306</b> | US-EMP (25 x 6)          | <b>0829435</b> |
|  |   |           |                | EMT (25 x 6) R           | <b>0817264</b> |
|  | KLM 1 (for end brackets E/MK, E/MK 1 and E/MBK)         | 100       | <b>1004319</b> | EMT (24 x 4) R           | <b>0816265</b> |
|  | KLM 2 (for end brackets CLIPFIX...)                     | 100       | <b>0807575</b> | UCT-TM 4 - UCT-TM 16     |                |
|  | KLM 3 (for end brackets CLIPFIX...)                     | 100       | <b>0811969</b> | US-EML (20 x 8)          | <b>0800458</b> |
|  |   |           |                | EML (20 x 8) R           | <b>0816786</b> |
|  |   |           |                | EMLP (20 x 8) R          | <b>0819482</b> |
|  |   |           |                | EMLC (20 x 8) R YE       | <b>0800235</b> |
|  | KLM 3-L (for end brackets CLIPFIX...)                   | 100       | <b>0814788</b> | US-EML (20 x 8)          | <b>0800458</b> |
|  |   |           |                | EML (20 x 8) R           | <b>0816786</b> |
|  |   |           |                | EMLP (20 x 8) R          | <b>0819482</b> |
|  |   |           |                | EMLC (20 x 8) R YE       | <b>0800235</b> |
|  | KLM-A (for end brackets CLIPFIX 35, E/UK and E/NS 35 N) | 100       | <b>1004348</b> | US-EMP (44 x 7)          | <b>0829438</b> |
|  |   |           |                | EMT (44 x 7)             | <b>0819275</b> |

### Cable binders PKB...

Cable binders have been used to bundle control cables and other cables for decades.

They are ideal for fixing cables and as an accessory for various cable markers.



|  | Length/width [mm] | Pcs./Pkt. | Color       | Type             | Order No.      |
|--|-------------------|-----------|-------------|------------------|----------------|
|  | 100 x 2.5         | 1000      | Transparent | PKB 100 x 2,5    | <b>1005457</b> |
|  | 140 x 3.6         | 1000      | Transparent | PKB 140 x 3,6    | <b>1005460</b> |
|  | 190 x 4.8         | 1000      | Transparent | PKB 190 x 4,8    | <b>1005473</b> |
|  | 200 x 2.5         | 1000      | Transparent | PKB 200 x 2,5    | <b>1005486</b> |
|  | 290 x 4.8         | 1000      | Transparent | PKB 290 x 4,8    | <b>1005499</b> |
|  | 370 x 4.8         | 1000      | Transparent | PKB 370 x 4,8    | <b>1005509</b> |
|  | 100 x 2.5         | 1000      | Black       | PKB 100 x 2,5 BK | <b>1005512</b> |
|  | 140 x 3.6         | 1000      | Black       | PKB 140 x 3,6 BK | <b>1005525</b> |
|  | 190 x 4.8         | 1000      | Black       | PKB 190 x 4,8 BK | <b>1005538</b> |
|  | 200 x 2.5         | 1000      | Black       | PKB 200 x 2,5 BK | <b>1005541</b> |
|  | 290 x 4.8         | 1000      | Black       | PKB 290 x 4,8 BK | <b>1005554</b> |
|  | 370 x 4.8         | 1000      | Black       | PKB 370 x 4,8 BK | <b>1005567</b> |

## Marker carriers for conductor marking

### Marking collars PATG... and PAB KTL...

The closed PATG marking collars are pushed onto the conductor before it is connected. The PAB-KTL... collars are particularly suited to the identification and simultaneous bundling of conductors with cable binder mounting.\*)



| Can be labeled with type                                  | Conductor diameter [mm] | Pcs./Pkt. | Type       | Order No.      |
|---|-------------------------|-----------|------------|----------------|
| US-WMT (10 x 4)... and EMT (10 x 4)<br>See page 22 and 28 | 0.6 - 1.2               | 1000      | PATG 0/10  | <b>1013795</b> |
|   | 1.5 - 2.5               | 1000      | PATG 1/10  | <b>1013805</b> |
|   | 2.0 - 4.0               | 1000      | PATG 2/10  | <b>1013818</b> |
|   | 4.0 - 7.0               | 500       | PATG 3/10  | <b>1013821</b> |
| US-WMT (12 x 4)...<br>See page 22                         | 0.6 - 1.2               | 1000      | PATG 0/12  | <b>0827076</b> |
|   | 1.5 - 2.5               | 1000      | PATG 1/12  | <b>0827077</b> |
|   | 2.0 - 4.0               | 1000      | PATG 2/12  | <b>0827078</b> |
|   | 4.0 - 7.0               | 500       | PATG 3/12  | <b>0827079</b> |
|   | 6.0 - 10.0              | 500       | PATG 4/12  | <b>0827080</b> |
| US-WMT (15 x 4)... and EMT (15 x 4)<br>See page 22 and 28 | 0.6 - 1.2               | 1000      | PATG 0/15  | <b>1013740</b> |
|   | 1.5 - 2.5               | 1000      | PATG 1/15  | <b>1013025</b> |
|   | 2.0 - 4.0               | 1000      | PATG 2/15  | <b>1013038</b> |
|   | 4.0 - 7.0               | 500       | PATG 3/15  | <b>1013041</b> |
|   | 6.0 - 10.0              | 500       | PATG 4/15  | <b>1013054</b> |
|   | 10.0 - 14.0             | 200       | PATG 5/15  | <b>1013067</b> |
|   | 14.0 - 22.0             | 200       | PATG 6/15  | <b>1013070</b> |
| US-WMT (18 x 4)...<br>See page 22                         | 0.6 - 1.2               | 1000      | PATG 0/18  | <b>0820507</b> |
|   | 1.5 - 2.5               | 1000      | PATG 1/18  | <b>0820510</b> |
|   | 2.0 - 4.0               | 1000      | PATG 2/18  | <b>0820523</b> |
|   | 4.0 - 7.0               | 500       | PATG 3/18  | <b>0820536</b> |
|   | 6.0 - 10.0              | 500       | PATG 4/18  | <b>0820549</b> |
|   | 10.0 - 14.0             | 200       | PATG 5/18  | <b>0828059</b> |
|   | 14.0 - 22.0             | 200       | PATG 6/18  | <b>0828062</b> |
| US-WMT (23 x 4)... and EMT (23 x 4)<br>See page 22 and 28 | 0.6 - 1.2               | 1000      | PATG 0/23  | <b>0828046</b> |
|   | 1.5 - 2.5               | 1000      | PATG 1/23  | <b>1013847</b> |
|   | 2.0 - 4.0               | 500       | PATG 2/23  | <b>1013850</b> |
|   | 4.0 - 7.0               | 500       | PATG 3/23  | <b>1013863</b> |
|   | 6.0 - 10.0              | 200       | PATG 4/23  | <b>0808011</b> |
|   | 10.0 - 14.0             | 200       | PATG 5/23  | <b>0808024</b> |
|   | 14.0 - 22.0             | 100       | PATG 6/23  | <b>0808037</b> |
|   | 1)                      | 200       | PAB-KTL 23 | <b>1013957</b> |
| US-WMT (30 x 4)...<br>See page 22                         | 1.5 - 2.5               | 500       | PATG 1/30  | <b>0822440</b> |
|   | 2.0 - 4.0               | 500       | PATG 2/30  | <b>0822453</b> |
|   | 4.0 - 7.0               | 200       | PATG 3/30  | <b>0822466</b> |
|   | 6.0 - 10.0              | 200       | PATG 4/30  | <b>0822479</b> |
|   | 10.0 - 14.0             | 200       | PATG 5/30  | <b>0822482</b> |
|   | 1)                      | 200       | PAB-KTL    | <b>1013261</b> |

\*) For suitable cable binders, see page 38.

## Marker carriers for conductor marking

### Plastic conductor markers KMK...

KMK plastic cable markers combine the functions of conductor marking and conductor bundling. Suitable insert labels are inserted into the markers and they are then sealed tightly.\*)



|  | Type  | Pcs./Pkt. | Order No.      | Can be labeled with type | Order No.      |
|--|-------|-----------|----------------|--------------------------|----------------|
|  | KMK   | 100       | <b>1005208</b> | US-EMP (29 × 8)          | <b>0829436</b> |
|  |       |           |                | EMT (29 × 8) R           | <b>0817277</b> |
|  | KMK 2 | 100       | <b>1005266</b> | US-EMP (29 × 8)          | <b>0829436</b> |
|  |       |           |                | EMT (29 × 8) R           | <b>0817277</b> |
|  | KMK 3 | 50        | <b>1005211</b> | US-EMP (40 × 17)         | <b>0829437</b> |
|  |       |           |                | EMT (40 × 17) R          | <b>0819275</b> |
|  | KMK 4 | 50        | <b>1005305</b> | US-EMP (40 × 17)         | <b>0829437</b> |
|  |       |           |                | EMT (40 × 17) R          | <b>0819275</b> |

### Conductor markers LM and KME

The LM and KME conductor markers consist of a plastic label with an injection molded cable binder. The transparent sealing cap of the LM holds the printed label and protects it from contamination. The KME is directly labeled with a self-adhesive label.

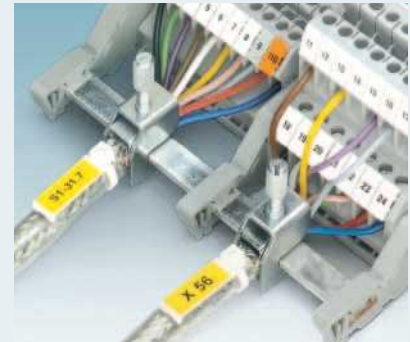

|  | Type | Pcs./Pkt. | Order No.      | Can be labeled with type | Order No.      |
|--|------|-----------|----------------|--------------------------|----------------|
|  | LM   | 100       | <b>1004377</b> | EMT (24 × 4) R           | <b>0816265</b> |
|  | KME  | 50        | <b>0807083</b> | EML (20 × 8)             | <b>0816786</b> |
|  |      |           |                | EMLC (20 × 8) R          | <b>0800235</b> |
|  |      |           |                | EMLP (20 × 8) R          | <b>0819482</b> |

\*) For suitable cable binders, see page 38.



## Marker carriers for device marking

### Device markers CARRIER-EMP 22, -EMLP 22 and -EMP

CARRIER-EMP 22 and -EMLP 22 marker carriers, with the appropriate markers, are used for the identification of buttons and switches. With the -EMP 22, markers are effortlessly snapped into place and with the -EMLP 22 they are adhered. Together with US-EMP... markers, the CARRIER-EMPs mark devices and control cabinets. The material is easily snapped into place.



|  | Can be labeled with type  | Pcs./ Pkt. | Type                          | Order No.      |                |                |
|--|---|------------|-------------------------------|----------------|----------------|----------------|
|  |   |            |                               | BK             | TR             | GY             |
|  | US-EMP (27 x 8)...<br>See page 24   | 50         | CARRIER-EMP 22 (27 x 8)       | <b>0827445</b> |                |                |
|  | US-EMP (27 x 12,5)...<br>See page 24  | 50         | CARRIER-EMP 22 (27 x 12,5)    | <b>0827446</b> |                |                |
|  | US-EMP (27 x 15)...<br>See page 24  | 50         | CARRIER-EMP 22 (27 x 15)      | <b>0827447</b> |                |                |
|  | US-EMP (27 x 18)...<br>See page 24  | 50         | CARRIER-EMP 22 (27 x 18)      | <b>0827448</b> |                |                |
|  | US-EMP (27 x 27)...<br>See page 24  | 50         | CARRIER-EMP 22 (27 x 27)      | <b>0827449</b> |                |                |
|  | US-EMLP (27 x 8)..., EML (26,5 x 7,5) R and EMLP (27 x 8) R SR<br>See page 25, 32 and 34        | 50         | CARRIER-EMLP 22 (27 x 8)      | <b>0828984</b> |                |                |
|  | US-EMLP (27 x 12,5)..., EML (26,5 x 12,5) R and EMLP (27 x 12,5) R SR<br>See page 25, 32 and 34 | 50         | CARRIER-EMLP 22 (27 x 12,5)   | <b>0828985</b> |                |                |
|  | US-EMLP (27 x 15)<br>See page 25  | 50         | CARRIER-EMLP 22 (27 x 15)     | <b>0828986</b> |                |                |
|  | US-EMLP (27 x 18)..., EML (26,5 x 17,5) R and EMLP (27 x 18) R SR<br>See page 25, 32 and 34     | 50         | CARRIER-EMLP 22 (27 x 18)     | <b>0828987</b> |                |                |
|  | US-EMLP (27 x 27)..., EML (26,5 x 26,5) R and EMLP (27 x 27) R SR<br>See page 25, 32 and 34     | 50         | CARRIER-EMLP 22 (27 x 27)     | <b>0828988</b> |                |                |
|  | US-EMP (17 x 15)...<br>See page 24  | 80         | CARRIER-EMP (17 x 15)         | <b>0827450</b> |                |                |
|  | US-EMP (27 x 15)...<br>See page 24  | 80         | CARRIER-EMP (27 x 15)         | <b>0827451</b> |                |                |
|  | US-EMP (49 x 15)...<br>See page 24  | 40         | CARRIER-EMP (49 x 15)         | <b>0827452</b> |                |                |
|  | US-EMP (60 x 15)...<br>See page 24  | 40         | CARRIER-EMP (60 x 15)         | <b>0827453</b> |                |                |
|  | US-EMP (60 x 30)...<br>See page 24  | 30         | CARRIER-EMP (60 x 30)         | <b>0827454</b> |                |                |
|  | US-EMP (85,6 x 54)...<br>See page 24  | 10         | CARRIER-EMP (85,6 x 54)       | <b>0829365</b> |                |                |
|  |   |            |                               |                |                |                |
|  | US-EMP (X x 15)...<br>See page 24   | 25         | CARRIER-EMP (1000 x 15)...    |                | <b>0829530</b> | <b>0829366</b> |
|  | US-EMP (X x 15)...<br>See page 24   | 25         | CARRIER/L-EMP (1000 x 15)...  |                | <b>0829560</b> | <b>0829559</b> |
|  | Cover for CARRIER/L-EMP (1000 x 15)   | 25         | CARRIER-EMP (1000 x 15) COVER |                | <b>0829520</b> |                |

# Terminal marking

## Explanation

The marking strips in UniCard sheet format are available in all standard pitches. Strips and markers can be easily separated and snapped into the high or flat marker groove. The assembly time can be considerably reduced by removing and mounting entire strips.



Large terminal markers for central and external labeling



|                  | UCT-TM 3,5     | UCT-TM 4       | UCT-TM 5       | UCT-TM 6       | UCT-TM 7,62    | UCT-TM 8       | UCT-TM 10      | UCT-TM 12      | UCT-TM 16      |
|------------------|----------------|----------------|----------------|----------------|----------------|----------------|----------------|----------------|----------------|
| <b>Sheet, WH</b> | <b>0829484</b> | <b>0828732</b> | <b>0828734</b> | <b>0828736</b> | <b>0828738</b> | <b>0828740</b> | <b>0829142</b> | <b>0829144</b> | <b>0829146</b> |
| Pitch            | 3.5            | 4              | 5              | 6              | 7.62           | 8              | 10             | 12             | 16             |

### Screw terminal blocks

|                        |    |  |  |  |  |  |  |  |  |
|------------------------|----|--|--|--|--|--|--|--|--|
| UT 2,5..., UTTB 2,5... | 5  |  |  |  |  |  |  |  |  |
| UT 4..., UTTB 4...     | 6  |  |  |  |  |  |  |  |  |
| UT 6..., UTME(D) 6...  | 8  |  |  |  |  |  |  |  |  |
| UT 10...               | 10 |  |  |  |  |  |  |  |  |



# Terminal block marking for Phoenix Contact



Large terminal markers for central and external labeling

|       | UCT-TM 3,5  | UCT-TM 4 | UCT-TM 5 | UCT-TM 6 | UCT-TM 7,62 | UCT-TM 8 | UCT-TM 10 | UCT-TM 12 | UCT-TM 16 |
|-------|-------------|----------|----------|----------|-------------|----------|-----------|-----------|-----------|
|       | See page 19 |          |          |          |             |          |           |           |           |
|       |             | TMT 4 R  | TMT 5 R  | TMT 6 R  |             | TMT 8 R  | TMT 10 R  | TMT 100 R | TMT 100 R |
|       | See page 27 |          |          |          |             |          |           |           |           |
| Pitch | 3.5         | 4        | 5        | 6        | 7.62        | 8        | 10        | 12        | 16        |

## Screw terminal blocks

|   |      |  |  |  |  |  |  |  |  |
|---|------|--|--|--|--|--|--|--|--|
| UT 2,5..., UTTB 2,5..., UTN 2,5...  | 5    |  |  |  |  |  |  |  |  |
| UT 4..., UTTB 4..., UTME(D) 4..., USST 4..., UTN 4...                                   | 6    |  |  |  |  |  |  |  |  |
| UT 6..., UTME(D) 6..., USST 6..., UTN 6...  | 8    |  |  |  |  |  |  |  |  |
| UT 10..., USST 10...  | 10   |  |  |  |  |  |  |  |  |
| UT 16..., UTI 16...   | 12   |  |  |  |  |  |  |  |  |
| UT 35   | 16   |  |  |  |  |  |  |  |  |
| UK 1,5 N..., USLKG 1,5 N  | 4    |  |  |  |  |  |  |  |  |
| UK 2,5 N..., USLKG 2,5 N, UK 3 N..., USLKG 3, UKK(B) 3..., UDK 3..., MTK(D)...          | 5    |  |  |  |  |  |  |  |  |
| UK 5 N..., USLKG 5 N, UDK 4..., UKK(B) 5, UDMTK(B) 5..., UKN 2,5..., UKN 5..., PIK 4... | 6    |  |  |  |  |  |  |  |  |
| UK 6 N..., USLKG 6 N, UKN 6..., PIK 6..., URTK..., UGSK..., URDK...                     | 8    |  |  |  |  |  |  |  |  |
| UK 10 N..., USLKG 10 N, UKKB 10..., UKN 10...   | 10   |  |  |  |  |  |  |  |  |
| U(I)K 16..., U(I)SLKG 16, UIKN 16...  | 12   |  |  |  |  |  |  |  |  |
| U(I)K 35..., U(I)SLKG 35, UIKN 35...  | 15   |  |  |  |  |  |  |  |  |
| UKH..., USLKG 50/95   | >16  |  |  |  |  |  |  |  |  |
| DIK(D) 1,5..., DOK(D) 1,5..., VIOK 1,5..., DLK(B) 2,5..., SLKK 5...                     | 6    |  |  |  |  |  |  |  |  |
| UVKB 4..., UHK 4..., USK 4..., UK 4..., UKK 4..., VBST 4...                             | 6    |  |  |  |  |  |  |  |  |
| TMC..., TMCP SOCKET...  | 12   |  |  |  |  |  |  |  |  |
| UK 5-HESI..., UKK 5-HESI..., UK-SI..., UK 6-FSI..., UK 10-DREHSI...                     | 8    |  |  |  |  |  |  |  |  |
| UK 6,3-HESI..., USIG...   | 10   |  |  |  |  |  |  |  |  |
| MT 1,5..., MTTB 1,5...  | 4    |  |  |  |  |  |  |  |  |
| MBK..., MBK 2,5..., MBK 3..., MSLKG 2,5, MBKKB 2,5...                                   | 5    |  |  |  |  |  |  |  |  |
| MBK 5..., MSLKG 5   | 6    |  |  |  |  |  |  |  |  |
| MBK 6..., MSLKG 6   | 8    |  |  |  |  |  |  |  |  |
| DFK 4...  | 6    |  |  |  |  |  |  |  |  |
| DFK 5...  | 9.5  |  |  |  |  |  |  |  |  |
| UW(V) 4...  | 8    |  |  |  |  |  |  |  |  |
| UW(V) 10.../16.../25...   | ≥ 10 |  |  |  |  |  |  |  |  |
| HDFK(V) 50..., HDFK(V) 95...  | > 18 |  |  |  |  |  |  |  |  |

All terminal blocks can also be labeled with the UniSheet material US-TMF 100.

 The pitch of the terminal block corresponds to the width of the label

 The pitch of the terminal block is greater than the width of the label

## Terminal block marking for Phoenix Contact



|  | UCT-TMF 3,5 | UCT-TMF 4 | UCT-TMF 5 | UCT-TMF 6 | UCT-TMF 8 | UCT-TMF 10 | UCT-TMF 12 | UCT-TMF 16 |    |
|--|-------------|-----------|-----------|-----------|-----------|------------|------------|------------|----|
|  | See page 19 |           |           |           |           |            |            |            |    |
|  |             | TMT 4 R   | TMT 5 R   | TMT 6 R   | TMT 8 R   | TMT 10 R   | TMT 100 R  | TMT 100 R  |    |
|  | See page 27 |           |           |           |           |            |            |            |    |
| Small terminal markers for central and external labeling | Pitch       | 3.5       | 4         | 5         | 6         | 8          | 10         | 12         | 16 |

### Screw terminal blocks

|   |      |  |  |  |  |  |  |  |  |
|---|------|--|--|--|--|--|--|--|--|
| UT 2,5..., UTTB 2,5..., UTN 2,5...  | 5    |  |  |  |  |  |  |  |  |
| UT 4..., UTTB 4..., UTME(D) 4..., USST 4..., UTN 4...                                   | 6    |  |  |  |  |  |  |  |  |
| UT 6..., UTME(D) 6..., USST 6..., UTN 6...  | 8    |  |  |  |  |  |  |  |  |
| UT 10..., USST 10...  | 10   |  |  |  |  |  |  |  |  |
| UT 16..., UTI 16...   | 12   |  |  |  |  |  |  |  |  |
| UT 35   | 16   |  |  |  |  |  |  |  |  |
| UK 1,5 N..., USLKG 1,5 N  | 4    |  |  |  |  |  |  |  |  |
| UK 2,5 N..., USLKG 2,5 N, UK 3 N..., USLKG 3, UKK(B) 3..., UDK 3..., MTK(D)...          | 5    |  |  |  |  |  |  |  |  |
| UK 5 N..., USLKG 5 N, UDK 4..., UKK(B) 5, UDMTK(B) 5..., UKN 2,5..., UKN 5..., PIK 4... | 6    |  |  |  |  |  |  |  |  |
| UK 6 N..., USLKG 6 N, UKN 6..., PIK 6..., URTK..., UGSK..., URDK...                     | 8    |  |  |  |  |  |  |  |  |
| UK 10 N..., USLKG 10 N, UKKB 10..., UKN 10...   | 10   |  |  |  |  |  |  |  |  |
| U(I)K 16..., U(I)SLKG 16, UIKN 16...  | 12   |  |  |  |  |  |  |  |  |
| U(I)K 35..., U(I)SLKG 35, UIKN 35...  | 15   |  |  |  |  |  |  |  |  |
| UKH..., USLKG 50/95   | >16  |  |  |  |  |  |  |  |  |
| DIK(D) 1,5..., DOK(D) 1,5..., VIOK 1,5..., DLK(B) 2,5..., SLKK 5...                     | 6    |  |  |  |  |  |  |  |  |
| UVKB 4..., UHK 4..., USK 4..., UK 4..., UKK 4..., VBST 4...                             | 6    |  |  |  |  |  |  |  |  |
| TMC..., TMCP SOCKET...  | 12   |  |  |  |  |  |  |  |  |
| UK 5-HESI..., UKK 5-HESI..., UK-SI..., UK 6-FSI..., UK 10-DREHSI...                     | 8    |  |  |  |  |  |  |  |  |
| UK 6,3-HESI..., USIG...   | 10   |  |  |  |  |  |  |  |  |
| MT 1,5..., MTTB 1,5...  | 4    |  |  |  |  |  |  |  |  |
| MBK..., MBK 2,5..., MBK 3..., MSLKG 2,5, MBKKB 2,5...                                   | 5    |  |  |  |  |  |  |  |  |
| MBK 5..., MSLKG 5   | 6    |  |  |  |  |  |  |  |  |
| MBK 6 ..., MSLKG 6  | 8    |  |  |  |  |  |  |  |  |
| DFK 4...  | 6    |  |  |  |  |  |  |  |  |
| DFK 5...  | 9.5  |  |  |  |  |  |  |  |  |
| UW(V) 4...  | 8    |  |  |  |  |  |  |  |  |
| UW(V) 10.../16.../25...   | ≥ 10 |  |  |  |  |  |  |  |  |
| HDFK(V) 50..., HDFK(V) 95...  | >18  |  |  |  |  |  |  |  |  |

All terminal blocks can also be labeled with the UniSheet material US-TMF 100.

 The pitch of the terminal block corresponds to the width of the label

 The pitch of the terminal block is greater than the width of the label

# Terminal block marking for Phoenix Contact



Large terminal markers for central labeling

|       | UCT-TM 3,5  | UCT-TM 4 | UCT-TM 5 | UCT-TM 6 | UCT-TM 7,62 | UCT-TM 8 | UCT-TM 10 | UCT-TM 12 | UCT-TM 16 |
|-------|-------------|----------|----------|----------|-------------|----------|-----------|-----------|-----------|
|       | See page 19 |          |          |          |             |          |           |           |           |
|       | TMT 4 R     | TMT 5 R  | TMT 6 R  |          |             | TMT 8 R  | TMT 10 R  | TMT 100 R | TMT 100 R |
|       | See page 27 |          |          |          |             |          |           |           |           |
| Pitch | 3.5         | 4        | 5        | 6        | 7.62        | 8        | 10        | 12        | 16        |

## Spring-cage terminal blocks

|                                   |      |  |  |  |  |  |  |  |  |
|-----------------------------------|------|--|--|--|--|--|--|--|--|
| ST 1,5/S...                       | 3.5  |  |  |  |  |  |  |  |  |
| ST 1,5...                         | 4    |  |  |  |  |  |  |  |  |
| ST 2,5... (except ST 2,5-3L...)   | 5    |  |  |  |  |  |  |  |  |
| ST 4...                           | 6    |  |  |  |  |  |  |  |  |
| ST 6..., STME(D) 6...             | 8    |  |  |  |  |  |  |  |  |
| ST 10...                          | 10   |  |  |  |  |  |  |  |  |
| ST 16...                          | 12   |  |  |  |  |  |  |  |  |
| ST 35...                          | 16   |  |  |  |  |  |  |  |  |
| ST 4-HESI (6,3 x 32), ST 4-FSI... | 8    |  |  |  |  |  |  |  |  |
| STU 2,5...                        | 5    |  |  |  |  |  |  |  |  |
| STU 4..., STTBU 4...              | 6    |  |  |  |  |  |  |  |  |
| STU 10...                         | 10   |  |  |  |  |  |  |  |  |
| STU 35...                         | 16   |  |  |  |  |  |  |  |  |
| STS 2,5..., STTBS 2,5...          | 5    |  |  |  |  |  |  |  |  |
| STS 4..., STTBS 4...              | 6    |  |  |  |  |  |  |  |  |
| STS 6...                          | 8    |  |  |  |  |  |  |  |  |
| STI 2,5..., STN 2,5...            | 5    |  |  |  |  |  |  |  |  |
| STI 4..., STN 4...                | 6    |  |  |  |  |  |  |  |  |
| STI 10..., STN 10...              | 10   |  |  |  |  |  |  |  |  |
| STI 16..., STN 16...              | 12   |  |  |  |  |  |  |  |  |
| STN 35...                         | 16   |  |  |  |  |  |  |  |  |
| SRTK 6..., SGSK 6..., SRDK 6...   | 8    |  |  |  |  |  |  |  |  |
| MSB(V) 2,5.../MSDB(V) 2,5...      | 5    |  |  |  |  |  |  |  |  |
| ZRV...                            | 7.62 |  |  |  |  |  |  |  |  |
| ZRTK..., ZGSK..., ZRDK...         | 8    |  |  |  |  |  |  |  |  |

All terminal blocks can also be labeled with the UniSheet material US-TMF 100.

 The pitch of the terminal block corresponds to the width of the label

 The pitch of the terminal block is greater than the width of the label

# Terminal block marking for Phoenix Contact



UCT-TMF 3,5 UCT-TMF 4 UCT-TMF 5 UCT-TMF 6 UCT-TMF 8 UCT-TMF 10 UCT-TMF 12 UCT-TMF 16

See page 19

TMT 4 R TMT 5 R TMT 6 R TMT 8 R TMT 10 R TMT 100 R TMT 100 R

See page 27

Small terminal markers for central and external labeling

| Pitch | 3.5 | 4 | 5 | 6 | 8 | 10 | 12 | 16 |
|-------|-----|---|---|---|---|----|----|----|
|-------|-----|---|---|---|---|----|----|----|

## Spring-cage terminal blocks

| Terminal Block                               | Pitch | 3.5 | 4 | 5 | 6 | 8 | 10 | 12 | 16 |
|--|-------|-----|---|---|---|---|----|----|----|
| ST 1,5/S...                                  | 3.5   | ■   |   |   |   |   |    |    |    |
| ST 1,5..., STTB 1,5...                       | 4     | ■   | ■ |   |   |   |    |    |    |
| ST 2,5..., STTB 2,5..., ST 2,5-3..., STIO... | 5     | ■   | ■ | ■ |   |   |    |    |    |
| ST 4..., STTB 4...                           | 6     | ■   | ■ | ■ | ■ |   |    |    |    |
| ST 6..., STME(D) 6...                        | 8     | ■   | ■ | ■ | ■ | ■ |    |    |    |
| ST 10...                                     | 10    | ■   | ■ | ■ | ■ | ■ | ■  |    |    |
| ST 16...                                     | 12    | ■   | ■ | ■ | ■ | ■ | ■  | ■  |    |
| ST 35...                                     | 16    | ■   | ■ | ■ | ■ | ■ | ■  | ■  | ■  |
| ST 4-HESI (6,3 x 32), ST 4-FSI...            | 8     | ■   | ■ | ■ | ■ | ■ |    |    |    |
| STU 2,5...                                   | 5     | ■   | ■ | ■ |   |   |    |    |    |
| STU 4..., STTBU 4...                         | 6     | ■   | ■ | ■ | ■ |   |    |    |    |
| STU 10...                                    | 10    | ■   | ■ | ■ | ■ | ■ | ■  |    |    |
| STU 35...                                    | 16    | ■   | ■ | ■ | ■ | ■ | ■  | ■  | ■  |
| STS 2,5..., STTBS 2,5...                     | 5     | ■   | ■ | ■ |   |   |    |    |    |
| STS 4..., STTBS 4...                         | 6     | ■   | ■ | ■ | ■ |   |    |    |    |
| STS 6...                                     | 8     | ■   | ■ | ■ | ■ | ■ |    |    |    |
| STI 2,5..., STN 2,5...                       | 5     | ■   | ■ | ■ |   |   |    |    |    |
| STI 4..., STN 4...                           | 6     | ■   | ■ | ■ | ■ |   |    |    |    |
| STI 10..., STN 10...                         | 10    | ■   | ■ | ■ | ■ | ■ | ■  |    |    |
| STI 16..., STN 16...                         | 12    | ■   | ■ | ■ | ■ | ■ | ■  | ■  |    |
| STN 35...                                    | 16    | ■   | ■ | ■ | ■ | ■ | ■  | ■  | ■  |
| SRTK 6..., SGSK 6..., SRDK 6...              | 8     | ■   | ■ | ■ | ■ | ■ |    |    |    |
| MSB(V) 2,5.../MSDB(V) 2,5...                 | 5/10  | ■   | ■ | ■ |   |   |    |    |    |
| ZRV...                                       | 7.62  | ■   | ■ | ■ | ■ |   |    |    |    |
| ZRTK..., ZGSK..., ZRDK...                    | 8     | ■   | ■ | ■ | ■ | ■ |    |    |    |
| ZFK 6-DREHSI...                              | 12    | ■   | ■ | ■ | ■ | ■ | ■  | ■  |    |
| ZFKK 2,5...                                  | 5     | ■   | ■ | ■ |   |   |    |    |    |
| ZDMTK 2,5...                                 | 6     | ■   | ■ | ■ | ■ |   |    |    |    |
| ZPV...                                       | 5     | ■   | ■ | ■ |   |   |    |    |    |
| MZFK(K) 1,5..., MZB 1,5...                   | 5     | ■   | ■ | ■ |   |   |    |    |    |
| MZDB 1,5...                                  | 10    | ■   | ■ | ■ | ■ | ■ | ■  |    |    |

All terminal blocks can also be labeled with the UniSheet material US-TMF 100.

■ The pitch of the terminal block corresponds to the width of the label

■ The pitch of the terminal block is greater than the width of the label

# Terminal block marking for Phoenix Contact



Large terminal markers for central and external labeling

| Pitch | 3.5         | 4        | 5        | 6        | 7.62        | 8        | 10        | 12        | 16        |
|-------|-------------|----------|----------|----------|-------------|----------|-----------|-----------|-----------|
|       | UCT-TM 3,5  | UCT-TM 4 | UCT-TM 5 | UCT-TM 6 | UCT-TM 7,62 | UCT-TM 8 | UCT-TM 10 | UCT-TM 12 | UCT-TM 16 |
|       | See page 19 |          |          |          |             |          |           |           |           |
|       | TMT 4 R     | TMT 5 R  | TMT 6 R  |          |             | TMT 8 R  | TMT 10 R  | TMT 100 R | TMT 100 R |
|       | See page 27 |          |          |          |             |          |           |           |           |

## Push-in connection terminal blocks

|   |     |  |  |  |  |  |  |  |  |
|---|-----|--|--|--|--|--|--|--|--|
| PIT 1,5/S..., PITTB 1,5/S...                        | 3.5 |  |  |  |  |  |  |  |  |
| PIT 2,5..., PITTB 2,5..., PITS 2,5..., PITBS 2,5... | 5   |  |  |  |  |  |  |  |  |
| PITI 2,5..., PITN 2,5...                            | 5   |  |  |  |  |  |  |  |  |
| PIT 4..., PITTB 4..., PITME(D) 4...                 | 6   |  |  |  |  |  |  |  |  |
| PITI 4..., PITN 4...                                | 6   |  |  |  |  |  |  |  |  |
| PIT 6..., PITME(D) 6...                             | 8   |  |  |  |  |  |  |  |  |
| PITI 6..., PITN 6...                                | 8   |  |  |  |  |  |  |  |  |

All PIT terminal blocks can also be labeled with the UniSheet material US-TM 100 in the central groove and US-TMF 100 in the lateral groove.

## Fast connection terminal blocks

|                   |   |  |  |  |  |  |  |  |  |
|-------------------|---|--|--|--|--|--|--|--|--|
| QTC(U)(S) 1,5..., | 5 |  |  |  |  |  |  |  |  |
| QTC(U)(S) 2,5..., | 6 |  |  |  |  |  |  |  |  |

## Bolt connection terminals

|                      |     |  |  |  |  |  |  |  |  |
|----------------------|-----|--|--|--|--|--|--|--|--|
| RT(O) 3...           | 12  |  |  |  |  |  |  |  |  |
| RT(O) 5...           | 16  |  |  |  |  |  |  |  |  |
| RT(O) 8...           | 20  |  |  |  |  |  |  |  |  |
| HV M.../1, HV M.../2 | >13 |  |  |  |  |  |  |  |  |
| UHV 25-240           | >26 |  |  |  |  |  |  |  |  |

All terminal blocks can also be labeled with the UniSheet material US-TMF 100.

 The pitch of the terminal block corresponds to the width of the label

 The pitch of the terminal block is greater than the width of the label

# Terminal block marking for Phoenix Contact



|  | UCT-TMF 3,5 | UCT-TMF 4 | UCT-TMF 5 | UCT-TMF 6 | UCT-TMF 8 | UCT-TMF 10 | UCT-TMF 12 | UCT-TMF 16 |    |
|--|-------------|-----------|-----------|-----------|-----------|------------|------------|------------|----|
|  | See page 19 |           |           |           |           |            |            |            |    |
|  |             | TMT 4 R   | TMT 5 R   | TMT 6 R   | TMT 8 R   | TMT 10 R   | TMT 100 R  | TMT 100 R  |    |
|  | See page 27 |           |           |           |           |            |            |            |    |
| Small terminal markers for central and external labeling | Pitch       | 3.5       | 4         | 5         | 6         | 8          | 10         | 12         | 16 |

## Push-in connection terminal blocks

|  |     |  |  |  |  |  |  |  |
|--|-----|--|--|--|--|--|--|--|
| PIT 1,5/S..., PITTB 1,5/S...                         | 3.5 |  |  |  |  |  |  |  |
| PIT 2,5..., PITTB 2,5..., PITS 2,5..., PITBTS 2,5... | 5   |  |  |  |  |  |  |  |
| PITI 2,5..., PITN 2,5...                             | 5   |  |  |  |  |  |  |  |
| PIT 4..., PITTB 4..., PITME(D) 4...                  | 6   |  |  |  |  |  |  |  |
| PITI 4..., PITN 4...                                 | 6   |  |  |  |  |  |  |  |
| PIT 6..., PITME(D) 6...                              | 8   |  |  |  |  |  |  |  |
| PITI 6..., PITN 6...                                 | 8   |  |  |  |  |  |  |  |

All PIT terminal blocks can also be labeled with the UniSheet material **US-TM 100** in the central groove and **US-TMF 100** in the lateral groove.

## Fast connection terminal blocks

|                                      |   |  |  |  |  |  |  |  |
|--------------------------------------|---|--|--|--|--|--|--|--|
| QTC(U)(S) 1,5..., QTTCB(U)(S) 1,5... | 5 |  |  |  |  |  |  |  |
| QTC(U)(S) 2,5...                     | 6 |  |  |  |  |  |  |  |

## Bolt connection terminals

|                      |     |  |  |  |  |  |  |  |
|----------------------|-----|--|--|--|--|--|--|--|
| RT(O) 3...           | 12  |  |  |  |  |  |  |  |
| RT(O) 5...           | 16  |  |  |  |  |  |  |  |
| RT(O) 8...           | 20  |  |  |  |  |  |  |  |
| HV M.../1, HV M.../2 | >13 |  |  |  |  |  |  |  |
| UHV 25-240           | >26 |  |  |  |  |  |  |  |

## COMBI connectors

|  |     |  |  |  |  |  |  |  |
|--|-----|--|--|--|--|--|--|--|
| UPBV 2,5...                            | 5   |  |  |  |  |  |  |  |
| UP 4..., UPBV 4...                     | 6   |  |  |  |  |  |  |  |
| PP-H 1,5/S..., PPC 1,5/S...            | 3.5 |  |  |  |  |  |  |  |
| PP-H 2,5/...                           | 5   |  |  |  |  |  |  |  |
| SP(V) 2,5..., SP(D)B 2,5..., SC 2,5... | 5   |  |  |  |  |  |  |  |
| SP 4..., SC 4...                       | 6   |  |  |  |  |  |  |  |
| DPB 1,5...                             | 5   |  |  |  |  |  |  |  |
| QP 1,5...                              | 5   |  |  |  |  |  |  |  |



All terminal blocks can also be labeled with the UniSheet material **US-TMF 100**.

 The pitch of the terminal block corresponds to the width of the label

 The pitch of the terminal block is greater than the width of the label



## Terminal block marking for Weidmüller

|                              |       |  |                |  |                |
|------------------------------|-------|---|----------------|---|----------------|
|                              |       | UCT1-TM 5   | UCT1-TM 6      | UCT1-TMF 5  | UCT1-TMF 6     |
| <b>Sheet, WH</b>             |       | <b>0829482</b>  | <b>0829483</b> | <b>0829237</b>  | <b>0829243</b> |
|                              | Pitch | 5   | 6              | 5   | 6              |
| <b>Screw terminal blocks</b> |       |   |                |   |                |
| AKZ 1,5/AKZ 2,5              | 5     |   |                |   |                |
| AKZ 4/AKE 4                  | 6     |   |                |   |                |
| DLD(A)2,5.../MAK 2,5/VLI 2,5 | 6     |   |                |   |                |
| SAK 10/16/35/95//EK 10/16/35 | 5     |   |                |   |                |
| SAK 2,5/4//EK 2,5/4          | 6     |   |                |   |                |
| SAKS.../SAK 6//EK 6          | 8     |   |                |   |                |
| WDK 2,5/4...                 | 5     |   |                |   |                |
| WDL 2,5...                   | 6     |   |                |   |                |
| WDT...                       | 5     |   |                |   |                |
| WDU (WPE) 1,5/2,5...         | 5     |   |                |   |                |
| WDU (WPE) 4...               | 6     |   |                |   |                |
| WDU (WPE) 6-240...           | 8     |   |                |   |                |
| WF...                        | 8     |   |                |   |                |
| WFF...                       | 6     |   |                |   |                |
| WNT 2,5                      | 5     |   |                |   |                |
| WNT 4                        | 6     |   |                |   |                |
| WNT 6-WNT 70N                | 8     |   |                |   |                |
| WSI 4                        | 6     |   |                |   |                |
| WSI 6                        | 6     |   |                |   |                |
| WTL 4/6                      | 6     |   |                |   |                |
| WTR 2,5...                   | 5     |   |                |   |                |
| WTR 4...                     | 6     |   |                |   |                |

 The pitch of the terminal block corresponds to the width of the label

 The pitch of the terminal block is greater than the width of the label





## Terminal block marking for Weidmüller

|   |   |  |           |  |            |
|---|---|---|-----------|---|------------|
|   |   | UCT1-TM 5   | UCT1-TM 6 | UCT1-TMF 5  | UCT1-TMF 6 |
| Sheet, WH   |   | 0829482   | 0829483   | 0829237   | 0829243    |
| Pitch   |   | 5   | 6         | 5   | 6          |
| <b>Spring-cage terminal blocks</b>                    |   |   |           |   |            |
| ZDK 2,5 (PE).../ZDLD 2,5.../ZMAK 2,5                  | 5 |   |           |   |            |
| ZDK 4 (PE)...   | 6 |   |           |   |            |
| ZDK 6/S   | 8 |   |           |   |            |
| ZDL 2,5/S.../ZDL 4/S...                               | 5 |   |           |   |            |
| ZDT 2,5 (PE).../ZT (PE) 2,5.../ZP 2,5...              | 5 |   |           |   |            |
| ZDU (ZPE) 10...- ZDU (ZPE) 35/ZEI 16...               | 5 |   |           |   |            |
| ZDU (ZPE) 2,5...                                      | 5 |   |           |   |            |
| ZDU (ZPE) 4...  | 6 |   |           |   |            |
| ZDU (ZPE) 6.../ZEI 6                                  | 8 |   |           |   |            |
| ZNT 2,5/10/16/35...                                   | 5 |   |           |   |            |
| ZNT 4   | 6 |   |           |   |            |
| ZNT 6   | 8 |   |           |   |            |
| ZPV 1,5.../ZIA 1,5.../ZVL 1,5...                      | 5 |   |           |   |            |
| ZSI 2,5.../ZSI 6...                                   | 5 |   |           |   |            |
| ZSI 6-2/FC  | 6 |   |           |   |            |
| ZT (PE) 4.../ZP 4...                                  | 6 |   |           |   |            |
| ZDT 6/ZTL 6   | 6 |   |           |   |            |
| ZTR 2,5.../ZDTR 2,5.../ZDL 2,5...                     | 5 |   |           |   |            |
| <b>IDC terminal blocks</b>                            |   |   |           |   |            |
| IDU (IPE 1,5) N.../ITR 1,5 N.../IDK 1,5 N (PE)...     | 5 |   |           |   |            |
| IDU (IPE) 2,5 N.../ITR 2,5 N...                       | 6 |   |           |   |            |
| IT 1,5.../IEK 1,5 N (PE).../IAK 1,5 N.../IIK 1,5 N... | 5 |   |           |   |            |
| <b>Push-in terminal blocks</b>                        |   |   |           |   |            |
| PDL 4...  | 5 |   |           |   |            |
| PDU (PPE) 2,5/4.../PDK 2,5/4 (PE)...                  | 5 |   |           |   |            |
| PDU (PPE) 6/10.../PDU (PPE) 16.../PEI 16...           | 8 |   |           |   |            |
| PNT 2,5/4   | 5 |   |           |   |            |
| PNT 6/10/16   | 8 |   |           |   |            |

 The pitch of the terminal block corresponds to the width of the label

 The pitch of the terminal block is greater than the width of the label

## Terminal block marking for Wago

|                                |   |  |  |  |  |
|--------------------------------|---|---|---|---|---|
|                                |   | UCT2-TM 5/6   | UCT1-TMF 5  | UCT1-TMF 5  | UCT1-TMF 6  |
| Sheet, WH                      |   | 0829249   | 0829237   | 0829237   | 0829243   |
| Pitch                          |   | 5   | 5   | 5   | 6   |
| Spring-cage terminal blocks    |   |   |   |   |   |
| 2001...                        | 4 |   |   |   |   |
| 2002..., 2003...               | 5 |   |   |   |   |
| 2004..., 2005..., 2006...      | 6 |   |   |   |   |
| 2010..., 2016...               | 8 |   |   |   |   |
| 261..., 264...                 | 6 |   |   |   |   |
| 270...                         | 5 |   |   |   |   |
| 279...                         | 4 |   |   |   |   |
| 280...                         | 5 |   |   |   |   |
| 280-8...                       | 5 |   |   |   |   |
| 281...                         | 6 |   |   |   |   |
| 282..., 283..., 284..., 285... | 8 |   |   |   |   |
| 290...                         | 5 |   |   |   |   |
| 727...                         | 6 |   |   |   |   |
| 769...                         | 5 |   |   |   |   |
| 775..., 776..., 777...         | 6 |   |   |   |   |
| 780...                         | 5 |   |   |   |   |
| 781...                         | 6 |   |   |   |   |
| 782..., 783..., 784..., 785... | 8 |   |   |   |   |
| 869..., 870..., 880...         | 5 |   |   |   |   |

All terminal blocks can also be labeled with the UniSheet material US2-TM 100.

 The pitch of the terminal block corresponds to the width of the label

 The pitch of the terminal block is greater than the width of the label

## Terminal block marking for Wieland

|                             |    |    |           |
|-----------------------------|----|---|-----------|
|                             |    | UCT3-TM 5   | UCT3-TM 6 |
| Sheet, WH                   |    | 0829251   | 0829252   |
| Pitch                       |    | 5   | 6         |
| Screw terminal blocks       |    |   |           |
| 9700 A/5...                 | 5  |   |           |
| 9700 A/6...                 | 6  |   |           |
| 9700 A/8...                 | 8  |   |           |
| 9700 A/10...                | 10 |   |           |
| 9700 A/12...                | 12 |   |           |
| 9700 A/16...                | 16 |   |           |
| 9700 A/6 ETK...             | 6  |   |           |
| 9700 A/8 ETK...             | 8  |   |           |
| 9700 A/10 ETK...            | 10 |   |           |
| WK(M) 2,5...                | 5  |   |           |
| WK 4..., WKI 4..., WKM 4... | 6  |   |           |
| WK 6...                     | 8  |   |           |
| WKN 10..., WKI 10...        | 10 |   |           |
| WKN 16..., WKI 16...        | 12 |   |           |
| WKN 35..., WKI 35...        | 16 |   |           |
| WKN 70...                   | 24 |   |           |
| WKN 150...                  | 28 |   |           |
| 9785 U/..., 9786 U/...      | 12 |   |           |

 The pitch of the terminal block corresponds to the width of the label

 The pitch of the terminal block is greater than the width of the label

## Terminal block marking for Wieland

|  |    |  |  |  |
|--|----|---|---|---|
|  |    | UCT-TM 4  | UCT3-TM 5   | UCT3-TM 6   |
| Sheet, WH                              |    | 0828732   | 0829251   | 0829252   |
| Pitch                                  |    | 4   | 5   | 6   |
| <b>Spring-cage terminal blocks</b>     |    |   |   |   |
| WKF 1,5...                             | 4  |   |   |   |
| WKF 1,5 KOI..., WKF 1,5 KOA...         | 5  |   |   |   |
| WK(I)F 2,5..., WKFN 2,5...             | 5  |   |   |   |
| WKF 4..., WKFN 4...                    | 6  |   |   |   |
| WKF 6...                               | 8  |   |   |   |
| WKF 10...                              | 10 |   |   |   |
| WK(I)F 16...                           | 12 |   |   |   |
| WKF 35...                              | 16 |   |   |   |
| <b>Fast connection terminal blocks</b> |    |   |   |   |
| WKC 1...                               | 5  |   |   |   |
| WKC 2,5...                             | 6  |   |   |   |
| WKF 16...WKC                           | 12 |   |   |   |

 The pitch of the terminal block corresponds to the width of the label

 The pitch of the terminal block is greater than the width of the label



## Terminal block marking for Conta-Clip

|  |       | UCT1-TM 5 |         | UCT1-TM 6 |         |
|--|-------|-----------|---------|-----------|---------|
|  |       | 0829482   | 0829483 | 0829237   | 0829243 |
| Sheet, WH  |       | 0829482   | 0829483 | 0829237   | 0829243 |
|  | Pitch | 5         | 6       | 5         | 6       |
| <b>Spring-cage terminal blocks</b>               |       |           |         |           |         |
| Z(S)RK 2,5..., ZSL 2,5...                        | 5     |           |         |           |         |
| ZRK 4..., ZSL 4...                               | 6     |           |         |           |         |
| ZRK (ZSL) 6..., ZRK (ZSL) 10..., ZRK (ZSL) 16... | 8     |           |         |           |         |
| ZRKD 2,5..., ZSLD 2,5...                         | 5     |           |         |           |         |
| ZIKD 2,5..., ZVMAK 2,5...                        | 5     |           |         |           |         |
| ZTRK 2,5...                                      | 5     |           |         |           |         |
| ZIZA 1,5...                                      | 5     |           |         |           |         |
| ZS...  | 5     |           |         |           |         |
| <b>Push-in terminal blocks</b>                   |       |           |         |           |         |
| FRK 1,5.../FSL 1,5...                            | 4     |           |         |           |         |
| FRK 2,5.../FSL 2,5...                            | 5     |           |         |           |         |
| FRK 4.../FSL 2,5...                              | 6     |           |         |           |         |
| FRKD 2,5.../FSLD 2,5...                          | 5     |           |         |           |         |
| FDLIS 2,5...                                     | 5     |           |         |           |         |
| FTRK 2,5...                                      | 5     |           |         |           |         |
| HSK...   | 8     |           |         |           |         |

 The pitch of the terminal block corresponds to the width of the label

 The pitch of the terminal block is greater than the width of the label

## Terminal block marking for Conta-Clip

|  |   |  |           |  |            |
|---|---|--|-----------|---|------------|
|   |   | UCT1-TM 5  | UCT1-TM 6 | UCT1-TMF 5  | UCT1-TMF 6 |
| Sheet, WH   |   | 0829482  | 0829483   | 0829237   | 0829243    |
| Pitch   |   | 5  | 6         | 5   | 6          |
| Screw terminal blocks   |   |  |           |   |            |
| RK 1,5-4...   | 6 |  |           |   |            |
| RK 2,5...   | 5 |  |           |   |            |
| RK 2,5-4...   | 6 |  |           |   |            |
| RK 6-10.../16.../35...  | 8 |  |           |   |            |
| RK 50...-RK 240...  | 8 |  |           |   |            |
| SL...   | 5 |  |           |   |            |
| RKD 2,5...  | 5 |  |           |   |            |
| RKD 4...  | 6 |  |           |   |            |
| DLI 2,5..., VMAK 2,5...   | 6 |  |           |   |            |
| IK (D) 2,5...   | 5 |  |           |   |            |
| TRK 1,5...  | 5 |  |           |   |            |
| TK.../STK...  | 8 |  |           |   |            |
| PTK...  | 8 |  |           |   |            |
| SIK 10...   | 8 |  |           |   |            |
| STK...  | 6 |  |           |   |            |
| SK...   | 8 |  |           |   |            |
| TSK 2,5   | 5 |  |           |   |            |
| FF.../SF...   | 6 |  |           |   |            |
| DLIS.../DLI...  | 6 |  |           |   |            |
| NT...   | 6 |  |           |   |            |
| RKA 2,5...  | 5 |  |           |   |            |
| RKA 4...  | 6 |  |           |   |            |
| RKA 10...   | 8 |  |           |   |            |
| RKB 4...  | 5 |  |           |   |            |
| KBL 2,5...  | 5 |  |           |   |            |
| KBL 2,5-4...  | 6 |  |           |   |            |
| KBL 6-10...   | 8 |  |           |   |            |

 The pitch of the terminal block corresponds to the width of the label

 The pitch of the terminal block is greater than the width of the label

## Terminal block marking for Klemсан

|                  |       | UCT1-TM 5      |                | UCT1-TM 6      |                |
|------------------|-------|----------------|----------------|----------------|----------------|
|                  |       | UCT1-TM 5      | UCT1-TM 6      | UCT1-TMF 5     | UCT1-TMF 6     |
| <b>Sheet, WH</b> |       | <b>0829482</b> | <b>0829483</b> | <b>0829237</b> | <b>0829243</b> |
|                  | Pitch | 5              | 6              | 5              | 6              |

### Screw terminal blocks

| Terminal block                          | Pitch | UCT1-TM 5 | UCT1-TM 6 | UCT1-TMF 5 | UCT1-TMF 6 |
|---|-------|-----------|-----------|------------|------------|
| AVK 2,5/PEK 2,5 K/WGT 2,5               | 5     | ■         |           | ■          |            |
| AVK 4.../AVK 2,5/4T/PEK 2,5/PEK 4/WGT 4 | 6     | ■         | ■         | ■          | ■          |
| AVK 6-240/PEK 6-35                      | 8     | ■         | ■         | ■          | ■          |
| AVK 6/10T-16/35T//WGT 6/WGT 10          | 8     | ■         | ■         | ■          | ■          |
| PIK 2,5...                              | 5     | ■         |           | ■          |            |
| PIK 4...                                | 6     | ■         | ■         | ■          | ■          |
| PIK 3...                                | 6     |           |           | ■          | ■          |
| ASK 2                                   | 8     |           |           | ■          | ■          |
| ASK 3                                   | 6     | ■         | ■         | ■          | ■          |
| ASK 4/AVK 4 FS                          | 8     | ■         | ■         | ■          | ■          |
| ASK 4S/ASK 4 LD                         | 6     | ■         | ■         | ■          | ■          |
| WGO...                                  | 8     | ■         | ■         | ■          | ■          |
| AYK 4...                                | 6     | ■         | ■         | ■          | ■          |
| AYK 10...                               | 8     |           |           | ■          | ■          |
| MVK 2,5 (T)                             | 5     |           |           | ■          |            |
| MVK 4 (T)                               | 6     |           |           | ■          | ■          |

### Spring-cage terminal blocks

| Terminal block                         | Pitch | UCT1-TM 5 | UCT1-TM 6 | UCT1-TMF 5 | UCT1-TMF 6 |
|--|-------|-----------|-----------|------------|------------|
| YBK 2,5 (T)                            | 5     | ■         |           | ■          |            |
| YBK 4 (T)                              | 6     | ■         | ■         | ■          | ■          |
| YBK 6 (T) (YBK 10 (T))                 | 8     | ■         | ■         | ■          | ■          |
| MYK 2,5 (T).../MYPPK 2,5...            | 5     |           |           | ■          |            |
| YBK 2,5 F.../YBK 3...                  | 5     |           |           | ■          |            |
| YBK 4...                               | 6     | ■         | ■         | ■          | ■          |
| YBK S.../YBK I...                      | 8     |           |           | ■          | ■          |
| YBK 2,5 A.../YBK 2,5 E.../YBK 2,5 C... | 5     | ■         |           | ■          |            |
| PCY 2,5...                             | 5     |           |           | ■          |            |

■ The pitch of the terminal block corresponds to the width of the label

■ The pitch of the terminal block is greater than the width of the label



## Terminal block marking for Cabur

|  |      |  |         |
|---|------|---|---------|
|   |      |   |         |
| Sheet, WH   |      | 0828750   | 0828752 |
| Pitch   |      | 5   | 6       |
| <b>Screw terminal blocks</b>  |      |   |         |
| AFO.2/1+2   | 6.5  |   |         |
| AFO.2/2+2   | 6.5  |   |         |
| CBC.2   | 5    |   |         |
| CBC.4   | 6    |   |         |
| CBC.6   | 8    |   |         |
| CBC.16  | 12   |   |         |
| CBC.35  | 16   |   |         |
| CBD.2   | 5.5  |   |         |
| CBD.4   | 6.5  |   |         |
| CBD.6   | 8    |   |         |
| CBD.10  | 10   |   |         |
| CBD.16  | 12   |   |         |
| CBD.35  | 16   |   |         |
| CBD.50  | 18   |   |         |
| CBD.70  | 20.5 |   |         |
| CBE.2   | 5    |   |         |
| CBR.2   | 5    |   |         |
| CVF.2   | 5    |   |         |
| CVF.4   | 6    |   |         |
| DAS.4   | 5    |   |         |
| DBC.2   | 5    |   |         |
| DSFA.4  | 6    |   |         |
| DSS.4   | 6    |   |         |
| EDM.2   | 5.5  |   |         |
| EDM.4   | 6.5  |   |         |
| EDM.6   | 8    |   |         |
| EDM.10  | 10   |   |         |
| EDM.16  | 12   |   |         |
| EDM.25  | 16   |   |         |
| EDM.35  | 18.5 |   |         |
| EDM.70  | 21   |   |         |

 The pitch of the terminal block corresponds to the width of the label

 The pitch of the terminal block is greater than the width of the label

## Terminal block marking for Cabur



|                              |       | UCT5-TM 5 | UCT5-TM 6 |
|------------------------------|-------|-----------|-----------|
| Sheet, WH                    |       | 0828750   | 0828752   |
|                              | Pitch | 5         | 6         |
| <b>Screw terminal blocks</b> |       |           |           |
| FDP.2                        | 6.5   |           |           |
| FFS.4                        | 6.5   |           |           |
| FPC.10                       | 12    |           |           |
| FPL.10                       | 12    |           |           |
| FVS.4                        | 6.5   |           |           |
| GPA.70                       | 20.5  |           |           |
| GPA.95                       | 26    |           |           |
| GPA.150                      | 31    |           |           |
| GPA.240                      | 37    |           |           |
| MPPA.4                       | 6     |           |           |
| MPS.2/SV                     | 5.5   |           |           |
| MPS.2/SW                     | 5.5   |           |           |
| MPS.2/SWP                    | 5.5   |           |           |
| MPS.4                        | 6     |           |           |
| PDF.2                        | 6.5   |           |           |
| RN.2                         | 5     |           |           |
| RP.4                         | 6     |           |           |
| SCB.4                        | 6.5   |           |           |
| SCB.6                        | 8     |           |           |
| SFO.4                        | 8     |           |           |
| SFR.4                        | 8     |           |           |
| SFR.6                        | 10    |           |           |
| SV.2                         | 5.5   |           |           |
| SV.4                         | 7     |           |           |
| SV.6                         | 8     |           |           |
| SV.10                        | 10.5  |           |           |

 The pitch of the terminal block corresponds to the width of the label

 The pitch of the terminal block is greater than the width of the label

## Terminal block marking for Cabur

|  |      |  |         |
|---|------|---|---------|
|   |      |   |         |
| Sheet, WH   |      | 0828750   | 0828752 |
| Pitch   |      | 5   | 6       |
| <b>Screw terminal blocks</b>  |      |   |         |
| TE.6  | 8    |   |         |
| TE.10   | 10   |   |         |
| TE.16   | 12   |   |         |
| TE.35   | 16   |   |         |
| TEC.6   | 8    |   |         |
| TEC.10  | 10   |   |         |
| TEC.16  | 12   |   |         |
| TEC.35  | 16   |   |         |
| TEC.70  | 20.5 |   |         |
| TED.4   | 6.5  |   |         |
| TEO.2   | 5.5  |   |         |
| TEO.4   | 6.5  |   |         |
| TC/DIN  | 5.5  |   |         |
| TC/PO   | 5.5  |   |         |
| TDE.2   | 6    |   |         |
| TLD.2   | 6    |   |         |
| TLE.2   | 6    |   |         |
| TLS.2   | 6    |   |         |
| TR.2  | 5    |   |         |
| TR.4  | 7.3  |   |         |
| VPC.2   | 5    |   |         |
| VPD.2   | 5    |   |         |
| <b>Spring-cage terminal block</b>   |      |   |         |
| HCD.1   | 5.08 |   |         |
| <b>Push-in connection terminal blocks</b>   |      |   |         |
| NCS   | 6    |   |         |
| NCV   | 6    |   |         |

 The pitch of the terminal block corresponds to the width of the label

 The pitch of the terminal block is greater than the width of the label



## Device marking for Phoenix Contact...



| UCT-TM 3,5 | UCT-TM 4<br>TMT 4 R | UCT-TM 5<br>TMT 5 R | UCT-TM 6<br>TMT 6 R | UCT-TM 16 | UCT-TMF 5<br>TMT 5 R | UCT-TMF 6<br>TMT 6 R | UCT-TMF 8<br>TMT 8 R | UCT-TMF 10<br>TMT 10 R | UCT-TMF 12 | UCT-TMF 16 | US-EMP (20 x 9) | EMT (62 x 10) R | EMT (62 x 46) R |
|------------|---------------------|---------------------|---------------------|-----------|----------------------|----------------------|----------------------|------------------------|------------|------------|-----------------|-----------------|-----------------|
|------------|---------------------|---------------------|---------------------|-----------|----------------------|----------------------|----------------------|------------------------|------------|------------|-----------------|-----------------|-----------------|

### TRABTECH

Lightning arrester FLASHTRAB compact PLUS

Lightning arrester FLASHTRAB PLUS

Lightning arrester FLASHTRAB compact

Surge arrester VALVETRAB compact

Surge arrester VALVETRAB MS

Device protection MAINS-PLUGTRAB

Pluggable surge protection cascade  
PLUGTRAB PT...

Modular terminal blocks with surge  
protection elements TT...

Basic terminal blocks TT-PI...



| UCT-TM 3,5 | UCT-TM 4<br>TMT 4 R | UCT-TM 5<br>TMT 5 R | UCT-TM 6<br>TMT 6 R | UCT-TM 16 | UCT-TMF 5<br>TMT 5 R | UCT-TMF 6<br>TMT 6 R | UCT-TMF 8<br>TMT 8 R | UCT-TMF 10<br>TMT 10 R | UCT-TMF 12 | UCT-TMF 16 | US-EMP (20 x 9) | EMT (62 x 10) R | EMT (62 x 46) R |
|------------|---------------------|---------------------|---------------------|-----------|----------------------|----------------------|----------------------|------------------------|------------|------------|-----------------|-----------------|-----------------|
|------------|---------------------|---------------------|---------------------|-----------|----------------------|----------------------|----------------------|------------------------|------------|------------|-----------------|-----------------|-----------------|

### AUTOMATION

Inline Modular

Inline Block IO

Interbus ST...

Fieldline Stand-Alone M12

Fieldline Modular M12

Fieldline Modular M8

Fieldline Extension M8

Fieldline Wireless IO M12

## UniSheet device marking for marker carriers from Phoenix Contact ...



| US-EMP (17 x 15) | US-EMP (27 x 8) | US-EMP (27 x 12.5) | US-EMP (27 x 15) | US-EMP (27 x 18) | US-EMP (27 x 27) | US-EMP (49 x 15) | US-EMP (60 x 15) | US-EMP (60 x 30) | US-EMP (85.6 x 54) | US-EMLP (27 x 8) | US-EMLP (27 x 12.5) | US-EMLP (27 x 15) | US-EMLP (27 x 18) | US-EMLP (27 x 27) |
|------------------|-----------------|--------------------|------------------|------------------|------------------|------------------|------------------|------------------|--------------------|------------------|---------------------|-------------------|-------------------|-------------------|
|------------------|-----------------|--------------------|------------------|------------------|------------------|------------------|------------------|------------------|--------------------|------------------|---------------------|-------------------|-------------------|-------------------|

### Phoenix Contact

CARRIER-EMP 22 (27 x 8)

CARRIER-EMP 22 (27 x 12.5)

CARRIER-EMP 22 (27 x 15)

CARRIER-EMP 22 (27 x 18)

CARRIER-EMP 22 (27 x 27)

CARRIER-EMP (17 x 15)

CARRIER-EMP (27 x 15)

CARRIER-EMP (49 x 15)

CARRIER-EMP (60 x 15)

CARRIER-EMP (60 x 30)

CARRIER-EMP (85.6 x 54)

CARRIER-EMLP 22 (27 x 8)

CARRIER-EMLP 22 (27 x 12.5)

CARRIER-EMLP 22 (27 x 15)

CARRIER-EMLP 22 (27 x 18)

CARRIER-EMLP 22 (27 x 27)

## Device marking for Siemens controllers



ET 200S  
S7-300

EMT (50/28 x 13) R...

EMT (50 x 26) R...

EMT (103 x 17) R...

EMT (103 x 23) R...

| Type                          | Order No. | Page | Type                    | Order No. | Page |
|-------------------------------|-----------|------|-------------------------|-----------|------|
| <b>A</b>                      |           |      | EML (100 x 90)R SR      | 0817141   | 32   |
|                               |           |      | EML (100 x E)RL SR      | 0815787   | 33   |
|                               |           |      | EML (101,6 x 25,4)RL SR | 0815790   | 32   |
|                               |           |      | EML (10 x 4)R           | 0815583   | 32   |
| AK-DST/DIK                    | 1000779   | 37   | EML (10 x 7)R           | 0816663   | 32   |
| AK-DST/UK                     | 1000708   | 37   | EML (10 x 7)R YE        | 0816676   | 32   |
|                               |           |      | EML (15 x 9)R           | 0815677   | 32   |
|                               |           |      | EML (15 x 9)R SR        | 0816032   | 32   |
|                               |           |      | EML (15 x 9)R YE        | 0816045   | 32   |
|                               |           |      | EML (16,5 x 5)R         | 0816702   | 32   |
|                               |           |      | EML (16,5 x 5)R YE      | 0816728   | 32   |
|                               |           |      | EML (16,5 x 5)RL        | 0816113   | 32   |
| CARRIER-EMLP 22 (27 x 12,5)   | 0828985   | 41   | EML (16,5 x 5)RL YE     | 0816126   | 32   |
| CARRIER-EMLP 22 (27 x 15)     | 0828986   | 41   | EML (16 x 7)R           | 0818001   | 32   |
| CARRIER-EMLP 22 (27 x 18)     | 0828987   | 41   | EML (16 x 7)R YE        | 0816731   | 32   |
| CARRIER-EMLP 22 (27 x 27)     | 0828988   | 41   | EML (17,5 x 8)R         | 0816744   | 32   |
| CARRIER-EMLP 22 (27 x 8)      | 0828984   | 41   | EML (17,5 x 8)R YE      | 0816757   | 32   |
| CARRIER-EMP (1000 x 15) COVER | 0829520   | 41   | EML (17,5 x 8)RL YE     | 0816139   | 32   |
| CARRIER-EMP (1000 x 15) GY    | 0829366   | 41   | EML (19 x 6)R           | 0816760   | 32   |
| CARRIER-EMP (1000 x 15) TR    | 0829530   | 41   | EML (20 x 7)R YE        | 0816773   | 32   |
| CARRIER-EMP (17 x 15)         | 0827450   | 41   | EML (20 x 8)R           | 0816786   | 32   |
| CARRIER-EMP (27 x 15)         | 0827451   | 41   | EML (20 x 8)R YE        | 0816799   | 32   |
| CARRIER-EMP (49 x 15)         | 0827452   | 41   | EML (21,5 x 21,5)R SR   | 0816812   | 32   |
| CARRIER-EMP (60 x 15)         | 0827453   | 41   | EML (25,4 x 12,7)R      | 0816825   | 32   |
| CARRIER-EMP (60 x 30)         | 0827454   | 41   | EML (25,4 x 12,7)R YE   | 0816838   | 32   |
| CARRIER-EMP (85,6 x 54)       | 0829365   | 41   | EML (26,5 x 12)R SR     | 0816854   | 32   |
| CARRIER-EMP 22 (27 x 12,5)    | 0827446   | 41   | EML (26,5 x 17,5)R SR   | 0816883   | 32   |
| CARRIER-EMP 22 (27 x 15)      | 0827447   | 41   | EML (26,5 x 17,5)R YE   | 0816896   | 32   |
| CARRIER-EMP 22 (27 x 18)      | 0827448   | 41   | EML (26,5 x 18,5)R SR   | 0816906   | 32   |
| CARRIER-EMP 22 (27 x 27)      | 0827449   | 41   | EML (26,5 x 26,5)R SR   | 0816919   | 32   |
| CARRIER-EMP 22 (27 x 8)       | 0827445   | 41   | EML (26,5 x 7,5)R SR    | 0816841   | 32   |
| CARRIER/L-EMP (1000 x 15) GY  | 0829559   | 41   | EML (30 x 20)R          | 0816922   | 32   |
| CARRIER/L-EMP (1000 x 15) TR  | 0829560   | 41   | EML (30 x 20)R YE       | 0816935   | 32   |
| CLIP-PROJECT ADVANCED         | 5146040   | 8    | EML (32 x 25)R YE       | 0800020   | 32   |
| CLIP-PROJECT PROFESSIONAL     | 5146053   | 8    | EML (37 x E)RL TR       | 0815716   | 33   |
|                               |           |      | EML (38,1 x 19)RL       | 0816171   | 32   |
|                               |           |      | EML (38 x 17)R          | 0816951   | 32   |
|                               |           |      | EML (40 x 15)R SR       | 0815729   | 32   |
|                               |           |      | EML (40 x 25)R          | 0818027   | 32   |
|                               |           |      | EML (40 x 25)R YE       | 0816977   | 32   |
| <b>E</b>                      |           |      | EML (40 x 8)R           | 0816980   | 32   |
| EML (100 x 73)R               | 0817125   | 32   | EML (50,8 x 25,4)RL     | 0816184   | 32   |
| EML (100 x 73)R SR            | 0817112   | 32   | EML (51 x 12,5)R TR     | 0815745   | 32   |
| EML (100 x 73)R YE            | 0817138   | 32   | EML (51 x 25)R          | 0817028   | 32   |
| EML (100 x 90)R               | 0817154   | 32   |                         |           |      |



## Index

| Type                   | Order No. | Page | Type                  | Order No. | Page |
|------------------------|-----------|------|-----------------------|-----------|------|
| EML (51 x 25)R SR      | 0817002   | 32   | EMLP (27 x 27)R SR    | 0827467   | 34   |
| EML (51 x 25)R YE      | 0817031   | 32   | EMLP (27 x 8)R SR     | 0819518   | 34   |
| EML (69,8 x 31,8)RL    | 0816197   | 32   | EMLP (45 x 15)R SR    | 0819547   | 34   |
| EML (70 x 32)R         | 0817060   | 32   | EMLP 24 (30 x 12)R    | 0819550   | 34   |
| EML (70 x 32)R SR      | 0817057   | 32   | EMLP 24 (30 x 12)R SR | 0819563   | 34   |
| EML (70 x 32)R YE      | 0817073   | 32   | EMLPR (100 x 30)      | 0800362   | 36   |
| EML (70 x 50)R         | 0817099   | 32   | EMLPR (26,5 x 14,5)   | 0800546   | 36   |
| EML (70 x 50)R SR      | 0817086   | 32   | EMLPR (26,5 x 17,5)   | 0800360   | 36   |
| EML (76,2 x 6,5)RL YE  | 0816207   | 32   | EMLPR (26,5 x 26,5)   | 0800361   | 36   |
| EML (90 x 5)R          | 0817109   | 32   | EMLPR (30 x 40)       | 0800359   | 36   |
| EML (D17,5)R           | 0815774   | 33   | EMLPR (80 x 42)       | 0800357   | 36   |
| EML (100 x 40)R        | 0800286   | 32   | EMLPR (80 x 60)       | 0800358   | 36   |
| EML (15 x 6) R YE      | 0819288   | 32   | EMLS (15 x 9)R SR     | 0800347   | 35   |
| EML (18 x 6)RL YE      | 0828460   | 32   | EMLS (19 x 6)R SR     | 0800343   | 35   |
| EML (24 x 4)R          | 0800061   | 32   | EMLS (20 x 20)R SR    | 0800344   | 35   |
| EML (25,4 x 12,7)RL    | 0816087   | 32   | EMLS (26,5 x 12)R SR  | 0800353   | 35   |
| EMLC (15 x 9)R YE      | 0800236   | 33   | EMLS (38,1 x 19)R SR  | 0800354   | 35   |
| EMLC (17,5 x 8)R YE    | 0800237   | 33   | EMLS (40 x 15)R SR    | 0800345   | 35   |
| EMLC (20 x 8)R YE      | 0800235   | 33   | EMLS (40 x 8)R SR     | 0800348   | 35   |
| EMLC (25,4 x 12,7)R YE | 0800238   | 33   | EMLS (60 x 30)R SR    | 0800355   | 35   |
| EMLC (25 x 8)R YE      | 0800240   | 33   | EMLS (70 x 150)R SR   | 0800351   | 35   |
| EMLC (38 x 17)R YE     | 0800557   | 33   | EMLS (70 x 32)R SR    | 0800346   | 35   |
| EMLC (40 x 8)R         | 0800554   | 33   | EMLS (76 x 51)R SR    | 0800350   | 35   |
| EMLC (40 x 8)R YE      | 0800555   | 33   | EMLS (85 x 32)R SR    | 0800356   | 35   |
| EMLC (51 x 25)R YE     | 0800558   | 33   | EMPPR (27 x 15)       | 0829535   | 36   |
| EMLF (108 x E)R        | 0800549   | 33   | EMPPR (27 x 18)       | 0829536   | 36   |
| EMLF (108 x E)R SR     | 0800551   | 33   | EMT (10 x 4)R         | 0816235   | 28   |
| EMLF (108 x E)R TR     | 0800552   | 33   | EMT (15 x 4)R         | 0817329   | 28   |
| EMLF (108 x E)R YE     | 0800550   | 33   | EMT (15 x 4)R BU      | 0817332   | 28   |
| EMLHT (15 x 15)R       | 0800341   | 33   | EMT (15 x 4)R RD      | 0816249   | 28   |
| EMLHT (40 x 15)R       | 0800339   | 33   | EMT (15 x 4)R YE      | 0817358   | 28   |
| EMLHT (45 x 5)R        | 0800337   | 33   | EMT (23 x 4)R         | 0817361   | 28   |
| EMLHT (50 x 10)R       | 0800338   | 33   | EMT (23 x 4)R YE      | 0817374   | 28   |
| EMLHT(D12)R            | 0801376   | 33   | EMT (24 x 4)R         | 0816265   | 28   |
| EMLHT (8 x 8)R         | 0800340   | 33   | EMT (25 x 6)R         | 0817264   | 28   |
| EMLP (13 x 9)R         | 0819453   | 34   | EMT (29 x 8)R         | 0817277   | 28   |
| EMLP (17,5 x 12)R      | 0819466   | 34   | EMT (29 x 8)R YE      | 0817280   | 28   |
| EMLP (17 x 7)R         | 0826844   | 34   | EMT (40 x 17)R        | 0817293   | 28   |
| EMLP (20 x 7)R         | 0819479   | 34   | EMT (103 x 17)R       | 0800039   | 35   |
| EMLP (20 x 8)R         | 0819482   | 34   | EMT (103 x 17)R TQ    | 0800041   | 35   |
| EMLP (22 x 12)R        | 0819495   | 34   | EMT (103 x 17)R YE    | 0800436   | 35   |
| EMLP (22 x 22)R SR     | 0825528   | 34   | EMT (103 x 23)R       | 0800040   | 35   |
| EMLP (27 x 12,5)R SR   | 0819521   | 34   | EMT (103 x 23)R YE    | 0800437   | 35   |
| EMLP (27 x 18)R SR     | 0819534   | 34   | EMT (44 x 7)R         | 0819275   | 28   |

| Type                 | Order No. | Page | Type           | Order No. | Page |
|----------------------|-----------|------|----------------|-----------|------|
| EMT (50/28 x 13)R    | 0800049   | 35   |                |           |      |
| EMT (50/28 x 13)R TQ | 0800050   | 35   |                |           |      |
| EMT (50/28 x 13)R YE | 0800438   | 35   |                |           |      |
| EMT (50 x 26)R       | 0800052   | 35   |                |           |      |
|                      |           |      | <b>M</b>       |           |      |
| EMT (50 x 26)R TQ    | 0800053   | 35   | MARKING BOX    | 5147100   | 9    |
| EMT (50 x 26)R YE    | 0800054   | 35   | MARKING BOX EN | 5147101   | 9    |
| EMT (62 x 10)R       | 0800057   | 35   |                |           |      |
| EMT (62 x 10)R YE    | 0800477   | 35   |                |           |      |
|                      |           |      |                |           |      |
| EMT (62 x 46)R       | 0800059   | 35   |                |           |      |
| EMT (62 x 46)R YE    | 0800478   | 35   |                |           |      |
|                      |           |      |                |           |      |
|                      |           |      | <b>P</b>       |           |      |
|                      |           |      |                |           |      |
|                      |           |      | PAB-KTL        | 1013261   | 39   |
|                      |           |      | PAB-KTL 23     | 1013957   | 39   |
|                      |           |      | PATG 0/10      | 1013795   | 39   |
|                      |           |      | PATG 0/12      | 0827076   | 39   |
|                      |           |      |                |           |      |
|                      |           |      | PATG 0/15      | 1013740   | 39   |
|                      |           |      | PATG 0/18      | 0820507   | 39   |
|                      |           |      | PATG 0/23      | 0828046   | 39   |
|                      |           |      | PATG 1/10      | 1013805   | 39   |
|                      |           |      |                |           |      |
|                      |           |      | PATG 1/12      | 0827077   | 39   |
|                      |           |      | PATG 1/15      | 1013025   | 39   |
|                      |           |      | PATG 1/18      | 0820510   | 39   |
|                      |           |      | PATG 1/23      | 1013847   | 39   |
|                      |           |      |                |           |      |
|                      |           |      | PATG 1/30      | 0822440   | 39   |
|                      |           |      | PATG 2/10      | 1013818   | 39   |
|                      |           |      | PATG 2/12      | 0827078   | 39   |
|                      |           |      | PATG 2/15      | 1013038   | 39   |
|                      |           |      |                |           |      |
|                      |           |      | PATG 2/18      | 0820523   | 39   |
|                      |           |      | PATG 2/23      | 1013850   | 39   |
|                      |           |      | PATG 2/30      | 0822453   | 39   |
|                      |           |      | PATG 3/10      | 1013821   | 39   |
|                      |           |      |                |           |      |
|                      |           |      | PATG 3/12      | 0827079   | 39   |
|                      |           |      | PATG 3/15      | 1013041   | 39   |
|                      |           |      | PATG 3/18      | 0820536   | 39   |
|                      |           |      | PATG 3/23      | 1013863   | 39   |
|                      |           |      |                |           |      |
|                      |           |      | PATG 3/30      | 0822466   | 39   |
|                      |           |      | PATG 4/12      | 0827080   | 39   |
|                      |           |      | PATG 4/15      | 1013054   | 39   |
|                      |           |      | PATG 4/18      | 0820549   | 39   |
|                      |           |      |                |           |      |
|                      |           |      | PATG 4/23      | 0808011   | 39   |
|                      |           |      | PATG 4/30      | 0822479   | 39   |
|                      |           |      | PATG 5/15      | 1013067   | 39   |
|                      |           |      | PATG 5/18      | 0828059   | 39   |

**G**

|               |         |    |
|---------------|---------|----|
| GBS 5-25 x 12 | 0810588 | 37 |
| GBS 5-25 x 5  | 0829126 | 37 |
| GBS-ZB/26 x 6 | 0809298 | 37 |

**K**

|         |         |    |
|---------|---------|----|
| KLM     | 1004306 | 38 |
| KLM 1   | 1004319 | 38 |
| KLM 2   | 0807575 | 38 |
| KLM 3   | 0811969 | 38 |
|         |         |    |
| KLM 3-L | 0814788 | 38 |
| KLM-A   | 1004348 | 38 |
| KME     | 0807083 | 40 |
| KMK     | 1005208 | 40 |
|         |         |    |
| KMK 2   | 1005266 | 40 |
| KMK 3   | 1005211 | 40 |
| KMK 4   | 1005305 | 40 |

**L**

|    |         |    |
|----|---------|----|
| LM | 1004377 | 40 |
|----|---------|----|

## Index

| Type                     | Order No. | Page | Type                          | Order No. | Page |
|--------------------------|-----------|------|-------------------------------|-----------|------|
| PATG 5/23                | 0808024   | 39   | THERMOMARK CARD-UCT-MAG2      | 5146563   | 6    |
| PATG 5/30                | 0822482   | 39   | THERMOMARK CARD-UCT-MAG3      | 5146613   | 6    |
| PATG 6/15                | 1013070   | 39   | THERMOMARK CARD-UCT-MAG4      | 5146614   | 6    |
| PATG 6/18                | 0828062   | 39   | THERMOMARK CARD-UCT-MAG5      | 5146615   | 6    |
| PATG 6/23                | 0808037   | 39   | THERMOMARK CARD-UCT-MAG6      | 5146616   | 6    |
| PKB 100 x 2,5            | 1005457   | 38   | THERMOMARK CARD-US-MAG1       | 5146451   | 6    |
| PKB 100 x 2,5 BK         | 1005512   | 38   | THERMOMARK ROLL               | 5146477   | 7    |
| PKB 140 x 3,6            | 1005460   | 38   | THERMOMARK ROLL SET           | 5147300   | 7    |
| PKB 140 x 3,6 BK         | 1005525   | 38   | THERMOMARK ROLL SET EN        | 5147301   | 7    |
| PKB 190 x 4,8            | 1005473   | 38   | THERMOMARK ROLL-CUTTER        | 5146422   | 7    |
| PKB 190 x 4,8 BK         | 1005538   | 38   | THERMOMARK ROLL-CUTTER/P      | 5146435   | 7    |
| PKB 200 x 2,5            | 1005486   | 38   | THERMOMARK ROLL-ERH           | 5146448   | 7    |
| PKB 200 x 2,5 BK         | 1005541   | 38   | THERMOMARK-ERH 500            | 5146309   | 7    |
| PKB 290 x 4,8            | 1005499   | 38   | THERMOMARK-RIBBON 110         | 5145384   | 7    |
| PKB 290 x 4,8 BK         | 1005554   | 38   | THERMOMARK-RIBBON 110 BU      | 0829544   | 7    |
| PKB 370 x 4,8            | 1005509   | 38   | THERMOMARK-RIBBON 110 GN      | 0829542   | 7    |
| PKB 370 x 4,8 BK         | 1005567   | 38   | THERMOMARK-RIBBON 110 RD      | 0829543   | 7    |
|                          |           |      | THERMOMARK-RIBBON 110-EMLHT   | 0800342   | 7    |
|                          |           |      | THERMOMARK-RIBBON 110-TC      | 0801371   | 6    |
|                          |           |      | THERMOMARK-RIBBON 110-WMSU    | 0801358   | 7    |
|                          |           |      | THERMOMARK-RIBBON 110-WMSU WH | 0801359   | 7    |
|                          |           |      | TL CASE                       | 0800613   | 6    |
|                          |           |      | TML (101 x 4,2)R TR           | 0816621   | 27   |
|                          |           |      | TML (101 x 9,5)R TR           | 0816647   | 27   |
|                          |           |      | TML (E x 4,2)R TR             | 0816715   | 27   |
|                          |           |      | TML (E x 9,5)R TR             | 0816634   | 27   |
|                          |           |      | TMT 4 R                       | 0816375   | 27   |
|                          |           |      | TMT 4 R BU                    | 0816333   | 27   |
|                          |           |      | TMT 4 R GN                    | 0816346   | 27   |
|                          |           |      | TMT 4 R OG                    | 0816359   | 27   |
|                          |           |      | TMT 4 R RD                    | 0816362   | 27   |
|                          |           |      | TMT 4 R YE                    | 0816388   | 27   |
|                          |           |      | TMT 5 R                       | 0816430   | 27   |
|                          |           |      | TMT 5 R BU                    | 0816391   | 27   |
|                          |           |      | TMT 5 R GN                    | 0816401   | 27   |
|                          |           |      | TMT 5 R OG                    | 0816414   | 27   |
|                          |           |      | TMT 5 R RD                    | 0816427   | 27   |
|                          |           |      | TMT 5 R YE                    | 0816443   | 27   |
|                          |           |      | TMT 6 R                       | 0816498   | 27   |
|                          |           |      | TMT 6 R BU                    | 0816456   | 27   |
|                          |           |      | TMT 6 R GN                    | 0816469   | 27   |
|                          |           |      | TMT 6 R OG                    | 0816472   | 27   |
|                          |           |      | TMT 6 R RD                    | 0816485   | 27   |
|                          |           |      | TMT 6 R YE                    | 0816508   | 27   |
| <b>S</b>                 |           |      |                               |           |      |
| SK 2,8 WH:REEL           | 0805205   | 27   |                               |           |      |
| SK 3,8 WH:REEL           | 0805218   | 27   |                               |           |      |
| SK 5,0 WH:REEL           | 0805221   | 27   |                               |           |      |
| SK 10,0 WH:REEL          | 0812188   | 27   |                               |           |      |
| STP 3,5-2                | 0830131   | 37   |                               |           |      |
| STP 3,5-3                | 0830132   | 37   |                               |           |      |
| STP 4-2                  | 0810575   | 37   |                               |           |      |
| STP 4-2-ZB               | 3038613   | 37   |                               |           |      |
| STP 5-2                  | 0800967   | 37   |                               |           |      |
| STP 5-2-ZB               | 3037643   | 37   |                               |           |      |
| STP 5-2/S                | 0800970   | 37   |                               |           |      |
| STP 5-3                  | 0810562   | 37   |                               |           |      |
| <b>T</b>                 |           |      |                               |           |      |
| THERMOMARK CARD          | 5146464   | 6    |                               |           |      |
| THERMOMARK CARD SET      | 5147200   | 6    |                               |           |      |
| THERMOMARK CARD SET EN   | 5147201   | 6    |                               |           |      |
| THERMOMARK CARD-UCT-MAG1 | 5146480   | 6    |                               |           |      |

# Index

| Type         | Order No. | Page | Type           | Order No. | Page |
|--------------|-----------|------|----------------|-----------|------|
| TMT 8 R      | 0816553   | 27   | UCT-TM 3,5 GN  | 0829509   | 19   |
| TMT 8 R BU   | 0816511   | 27   | UCT-TM 3,5 OG  | 0829506   | 19   |
| TMT 8 R GN   | 0816524   | 27   | UCT-TM 3,5 RD  | 0829505   | 19   |
| TMT 8 R OG   | 0816537   | 27   | UCT-TM 3,5 VT  | 0829507   | 19   |
| TMT 8 R RD   | 0816540   | 27   | UCT-TM 4       | 0828732   | 19   |
| TMT 8 R YE   | 0816566   | 27   | UCT-TM 4 BU    | 0829152   | 19   |
| TMT 10 R     | 0816210   | 27   | UCT-TM 4 GN    | 0829153   | 19   |
| TMT 100 R    | 0816605   | 27   | UCT-TM 4 OG    | 0829150   | 19   |
| TMT 100 R BU | 0816223   | 27   | UCT-TM 4 RD    | 0829149   | 19   |
| TMT 100 R GN | 0816579   | 27   | UCT-TM 4 VT    | 0829151   | 19   |
| TMT 100 R OG | 0816582   | 27   | UCT-TM 4 YE    | 0828733   | 19   |
| TMT 100 R RD | 0816595   | 27   | UCT-TM 5       | 0828734   | 19   |
| TMT 100 R YE | 0816618   | 27   | UCT-TM 5 BU    | 0829157   | 19   |
| TMT TOOL     | 0816650   | 27   | UCT-TM 5 GN    | 0829158   | 19   |
|              |           |      | UCT-TM 5 OG    | 0829155   | 19   |
|              |           |      | UCT-TM 5 RD    | 0829154   | 19   |
|              |           |      | UCT-TM 5 VT    | 0829156   | 19   |
|              |           |      | UCT-TM 5 YE    | 0828735   | 19   |
|              |           |      | UCT-TM 6       | 0828736   | 19   |
|              |           |      | UCT-TM 6 BU    | 0829162   | 19   |
|              |           |      | UCT-TM 6 GN    | 0829163   | 19   |
|              |           |      | UCT-TM 6 OG    | 0829160   | 19   |
|              |           |      | UCT-TM 6 RD    | 0829159   | 19   |
|              |           |      | UCT-TM 6 VT    | 0829161   | 19   |
|              |           |      | UCT-TM 6 YE    | 0828737   | 19   |
|              |           |      | UCT-TM 7,62    | 0828738   | 19   |
|              |           |      | UCT-TM 7,62 BU | 0829513   | 19   |
|              |           |      | UCT-TM 7,62 GN | 0829514   | 19   |
|              |           |      | UCT-TM 7,62 OG | 0829511   | 19   |
|              |           |      | UCT-TM 7,62 RD | 0829510   | 19   |
|              |           |      | UCT-TM 7,62 VT | 0829512   | 19   |
|              |           |      | UCT-TM 8       | 0828740   | 19   |
|              |           |      | UCT-TM 8 BU    | 0829167   | 19   |
|              |           |      | UCT-TM 8 GN    | 0829168   | 19   |
|              |           |      | UCT-TM 8 OG    | 0829165   | 19   |
|              |           |      | UCT-TM 8 RD    | 0829164   | 19   |
|              |           |      | UCT-TM 8 VT    | 0829166   | 19   |
|              |           |      | UCT-TM 8 YE    | 0828741   | 19   |
|              |           |      | UCT-TMF 10     | 0829204   | 19   |
|              |           |      | UCT-TMF 10 BU  | 0829209   | 19   |
|              |           |      | UCT-TMF 10 GN  | 0829210   | 19   |
|              |           |      | UCT-TMF 10 OG  | 0829206   | 19   |
|              |           |      | UCT-TMF 10 RD  | 0829205   | 19   |
|              |           |      | UCT-TMF 10 VT  | 0829208   | 19   |
|              |           |      | UCT-TMF 10 YE  |           |      |
|              |           |      | UCT-TM 3,5     |           |      |
|              |           |      | UCT-TM 3,5 BU  |           |      |

## U

|               |         |    |                |         |    |
|---------------|---------|----|----------------|---------|----|
| UBE           | 0800310 | 37 | UCT-TM 6 GN    | 0829163 | 19 |
| UBE/D         | 0800307 | 37 | UCT-TM 6 OG    | 0829160 | 19 |
| UCT-TM 10     | 0829142 | 19 | UCT-TM 6 RD    | 0829159 | 19 |
| UCT-TM 10 BU  | 0829172 | 19 | UCT-TM 6 VT    | 0829161 | 19 |
| UCT-TM 10 GN  | 0829173 | 19 | UCT-TM 6 YE    | 0828737 | 19 |
| UCT-TM 10 OG  | 0829170 | 19 | UCT-TM 7,62    | 0828738 | 19 |
| UCT-TM 10 RD  | 0829169 | 19 | UCT-TM 7,62 BU | 0829513 | 19 |
| UCT-TM 10 VT  | 0829171 | 19 | UCT-TM 7,62 GN | 0829514 | 19 |
| UCT-TM 10 YE  | 0829143 | 19 | UCT-TM 7,62 OG | 0829511 | 19 |
| UCT-TM 12     | 0829144 | 19 | UCT-TM 7,62 RD | 0829510 | 19 |
| UCT-TM 12 BU  | 0829177 | 19 | UCT-TM 7,62 VT | 0829512 | 19 |
| UCT-TM 12 GN  | 0829178 | 19 | UCT-TM 8       | 0828740 | 19 |
| UCT-TM 12 OG  | 0829175 | 19 | UCT-TM 8 BU    | 0829167 | 19 |
| UCT-TM 12 RD  | 0829174 | 19 | UCT-TM 8 GN    | 0829168 | 19 |
| UCT-TM 12 VT  | 0829176 | 19 | UCT-TM 8 OG    | 0829165 | 19 |
| UCT-TM 12 YE  | 0829145 | 19 | UCT-TM 8 RD    | 0829164 | 19 |
| UCT-TM 16     | 0829146 | 19 | UCT-TM 8 VT    | 0829166 | 19 |
| UCT-TM 16 BU  | 0829182 | 19 | UCT-TM 8 YE    | 0828741 | 19 |
| UCT-TM 16 GN  | 0829183 | 19 | UCT-TMF 10     | 0829204 | 19 |
| UCT-TM 16 OG  | 0829180 | 19 | UCT-TMF 10 BU  | 0829209 | 19 |
| UCT-TM 16 RD  | 0829179 | 19 | UCT-TMF 10 GN  | 0829210 | 19 |
| UCT-TM 16 YE  | 0829147 | 19 | UCT-TMF 10 OG  | 0829206 | 19 |
| UCT-TM 3,5    | 0829484 | 19 | UCT-TMF 10 RD  | 0829205 | 19 |
| UCT-TM 3,5 BU | 0829508 | 19 | UCT-TMF 10 VT  | 0829208 | 19 |

## Index

| Type           | Order No. | Page | Type                      | Order No. | Page |
|----------------|-----------|------|---------------------------|-----------|------|
| UCT-TMF 10 YE  | 0829207   | 19   | UCT-TMF 8 RD              | 0829199   | 19   |
| UCT-TMF 12     | 0829214   | 19   | UCT-TMF 8 VT              | 0829201   | 19   |
| UCT-TMF 12 BU  | 0829216   | 19   | UCT-TMF 8 YE              | 0828749   | 19   |
| UCT-TMF 12 GN  | 0829217   | 19   | UCT-WMS 3,2 (12 x 4)      | 0828570   | 22   |
| UCT-TMF 12 OG  | 0829213   | 19   | UCT-WMS 3,2 (12 x 4) YE   | 0828572   | 22   |
| UCT-TMF 12 RD  | 0829212   | 19   | UCT-WMS 4,7 (12 x 5,5)    | 0828571   | 22   |
| UCT-TMF 12 VT  | 0829215   | 19   | UCT-WMS 4,7 (12 x 5,5) YE | 0828573   | 22   |
| UCT-TMF 12 YE  | 0829211   | 19   | UCT1-TM 5                 | 0829482   | 20   |
| UCT-TMF 16     | 0829218   | 19   | UCT1-TM 5 BU              | 0829229   | 20   |
| UCT-TMF 16 BU  | 0829223   | 19   | UCT1-TM 5 GN              | 0829230   | 20   |
| UCT-TMF 16 GN  | 0829224   | 19   | UCT1-TM 5 OG              | 0829227   | 20   |
| UCT-TMF 16 OG  | 0829220   | 19   | UCT1-TM 5 RD              | 0829226   | 20   |
| UCT-TMF 16 RD  | 0829219   | 19   | UCT1-TM 5 YE              | 0829228   | 20   |
| UCT-TMF 16 YE  | 0829221   | 19   | UCT1-TM 6                 | 0829483   | 20   |
| UCT-TMF 3,5    | 0829486   | 19   | UCT1-TM 6 BU              | 0829235   | 20   |
| UCT-TMF 3,5 BU | 0829518   | 19   | UCT1-TM 6 GN              | 0829236   | 20   |
| UCT-TMF 3,5 GN | 0829519   | 19   | UCT1-TM 6 OG              | 0829233   | 20   |
| UCT-TMF 3,5 RD | 0829515   | 19   | UCT1-TM 6 RD              | 0829232   | 20   |
| UCT-TMF 3,5 VT | 0829517   | 19   | UCT1-TM 6 YE              | 0829234   | 20   |
| UCT-TMF 3,5 YE | 0829487   | 19   | UCT1-TMF 5                | 0829237   | 20   |
| UCT-TMF 4      | 0828742   | 19   | UCT1-TMF 5 BU             | 0829241   | 20   |
| UCT-TMF 4 BU   | 0829187   | 19   | UCT1-TMF 5 GN             | 0829242   | 20   |
| UCT-TMF 4 GN   | 0829188   | 19   | UCT1-TMF 5 OG             | 0829239   | 20   |
| UCT-TMF 4 OG   | 0829185   | 19   | UCT1-TMF 5 RD             | 0829238   | 20   |
| UCT-TMF 4 RD   | 0829184   | 19   | UCT1-TMF 5 YE             | 0829240   | 20   |
| UCT-TMF 4 VT   | 0829186   | 19   | UCT1-TMF 6                | 0829243   | 20   |
| UCT-TMF 4 YE   | 0828743   | 19   | UCT1-TMF 6 BU             | 0829247   | 20   |
| UCT-TMF 5      | 0828744   | 19   | UCT1-TMF 6 GN             | 0829248   | 20   |
| UCT-TMF 5 BU   | 0829192   | 19   | UCT1-TMF 6 OG             | 0829245   | 20   |
| UCT-TMF 5 GN   | 0829193   | 19   | UCT1-TMF 6 RD             | 0829244   | 20   |
| UCT-TMF 5 RD   | 0829189   | 19   | UCT1-TMF 6 YE             | 0829246   | 20   |
| UCT-TMF 5 VT   | 0829191   | 19   | UCT2-TM 5/6               | 0829249   | 21   |
| UCT-TMF 5 YE   | 0828745   | 19   | UCT3-TM 5                 | 0829251   | 21   |
| UCT-TMF 6      | 0828746   | 19   | UCT3-TM 6                 | 0829252   | 21   |
| UCT-TMF 6 BU   | 0829197   | 19   | UCT5-TM 5                 | 0828750   | 21   |
| UCT-TMF 6 GN   | 0829198   | 19   | UCT5-TM 6                 | 0828752   | 21   |
| UCT-TMF 6 OG   | 0829195   | 19   | US-EML (104 x 140)        | 0800465   | 25   |
| UCT-TMF 6 RD   | 0829194   | 19   | US-EML (104 x 140) SR     | 0800466   | 25   |
| UCT-TMF 6 VT   | 0829196   | 19   | US-EML (104 x 140) YE     | 0800467   | 25   |
| UCT-TMF 6 YE   | 0828747   | 19   | US-EML (104 x 3,8)        | 0800464   | 25   |
| UCT-TMF 8      | 0828748   | 19   | US-EML (17,5 x 8)         | 0800461   | 25   |
| UCT-TMF 8 BU   | 0829202   | 19   | US-EML (17,5 x 8) YE      | 0800463   | 25   |
| UCT-TMF 8 GN   | 0829203   | 19   | US-EML (20 x 8)           | 0800458   | 25   |
| UCT-TMF 8 OG   | 0829200   | 19   | US-EML (20 x 8) YE        | 0800460   | 25   |

## Index

| Type                   | Order No. | Page | Type                   | Order No. | Page |
|------------------------|-----------|------|------------------------|-----------|------|
| US-EMLC (20 x 8)       | 0800468   | 25   | US-EMLP (49 x 15) SR   | 0828902   | 25   |
| US-EMLC (20 x 8) YE    | 0800469   | 25   | US-EMLP (49 x 15) YE   | 0828901   | 25   |
| US-EMLC (40 x 8)       | 0800470   | 25   | US-EMLP (60 x 15)      | 0828804   | 25   |
| US-EMLC (40 x 8) YE    | 0800471   | 25   | US-EMLP (60 x 15) SR   | 0828904   | 25   |
| US-EMLP (100 x 60)     | 0828807   | 25   | US-EMLP (60 x 15) YE   | 0828903   | 25   |
| US-EMLP (100 x 60) SR  | 0828910   | 25   | US-EMLP (60 x 30)      | 0828805   | 25   |
| US-EMLP (100 x 60) YE  | 0828909   | 25   | US-EMLP (60 x 30) SR   | 0828906   | 25   |
| US-EMLP (11 x 9)       | 0828789   | 25   | US-EMLP (60 x 30) YE   | 0828905   | 25   |
| US-EMLP (11 x 9) SR    | 0828872   | 25   | US-EMLP (85,6 x 54)    | 0828806   | 25   |
| US-EMLP (11 x 9) YE    | 0828871   | 25   | US-EMLP (85,6 x 54) SR | 0828908   | 25   |
| US-EMLP (15 x 5)       | 0828790   | 25   | US-EMLP (85,6 x 54) YE | 0828907   | 25   |
| US-EMLP (15 x 5) SR    | 0828874   | 25   | US-EMP (100 x 15)      | 0829521   | 24   |
| US-EMLP (15 x 5) YE    | 0828873   | 25   | US-EMP (100 x 15) SR   | 0829523   | 24   |
| US-EMLP (17 x 15)      | 0828793   | 25   | US-EMP (100 x 15) YE   | 0829522   | 24   |
| US-EMLP (17 x 15) SR   | 0828880   | 25   | US-EMP (17 x 15)       | 0828774   | 24   |
| US-EMLP (17 x 15) YE   | 0828879   | 25   | US-EMP (17 x 15) SR    | 0828843   | 24   |
| US-EMLP (17 x 7)       | 0828792   | 25   | US-EMP (20 x 9)        | 0829439   | 24   |
| US-EMLP (17 x 7) SR    | 0828878   | 25   | US-EMP (25 x 6)        | 0829435   | 24   |
| US-EMLP (17 x 7) YE    | 0828877   | 25   | US-EMP (27 x 12,5)     | 0828776   | 24   |
| US-EMLP (20 x 9)       | 0828795   | 25   | US-EMP (27 x 12,5) SR  | 0828847   | 24   |
| US-EMLP (20 x 9) SR    | 0828884   | 25   | US-EMP (27 x 12,5) YE  | 0828846   | 24   |
| US-EMLP (20 x 9) YE    | 0828883   | 25   | US-EMP (27 x 15)       | 0828777   | 24   |
| US-EMLP (22 x 22)      | 0828796   | 25   | US-EMP (27 x 15) SR    | 0828849   | 24   |
| US-EMLP (22 x 22) SR   | 0828886   | 25   | US-EMP (27 x 15) YE    | 0828848   | 24   |
| US-EMLP (22 x 22) YE   | 0828885   | 25   | US-EMP (27 x 18)       | 0828778   | 24   |
| US-EMLP (27 x 12,5)    | 0828798   | 25   | US-EMP (27 x 18) SR    | 0828851   | 24   |
| US-EMLP (27 x 12,5) SR | 0828892   | 25   | US-EMP (27 x 18) YE    | 0828850   | 24   |
| US-EMLP (27 x 12,5) YE | 0828891   | 25   | US-EMP (27 x 27)       | 0828779   | 24   |
| US-EMLP (27 x 15)      | 0828799   | 25   | US-EMP (27 x 27) SR    | 0828853   | 24   |
| US-EMLP (27 x 15) SR   | 0828894   | 25   | US-EMP (27 x 27) YE    | 0828852   | 24   |
| US-EMLP (27 x 15) YE   | 0828893   | 25   | US-EMP (27 x 8)        | 0828775   | 24   |
| US-EMLP (27 x 18)      | 0828800   | 25   | US-EMP (27 x 8) SR     | 0828845   | 24   |
| US-EMLP (27 x 18) SR   | 0828896   | 25   | US-EMP (27 x 8) YE     | 0828844   | 24   |
| US-EMLP (27 x 18) YE   | 0828895   | 25   | US-EMP (29 x 8)        | 0829436   | 24   |
| US-EMLP (27 x 27)      | 0828801   | 25   | US-EMP (29 x 8) YE     | 0829440   | 24   |
| US-EMLP (27 x 27) SR   | 0828898   | 25   | US-EMP (40 x 17)       | 0829437   | 24   |
| US-EMLP (27 x 27) YE   | 0828897   | 25   | US-EMP (44 x 7)        | 0829438   | 24   |
| US-EMLP (27 x 8)       | 0828797   | 25   | US-EMP (49 x 15)       | 0828780   | 24   |
| US-EMLP (27 x 8) SR    | 0828890   | 25   | US-EMP (49 x 15) YE    | 0828854   | 24   |
| US-EMLP (27 x 8) YE    | 0828889   | 25   | US-EMP (60 x 15)       | 0828781   | 24   |
| US-EMLP (35 x 9)       | 0828802   | 25   | US-EMP (60 x 15) SR    | 0828857   | 24   |
| US-EMLP (35 x 9) SR    | 0829430   | 25   | US-EMP (60 x 15) YE    | 0828856   | 24   |
| US-EMLP (35 x 9) YE    | 0828899   | 25   | US-EMP (60 x 30)       | 0828782   | 24   |
| US-EMLP (49 x 15)      | 0828803   | 25   | US-EMP (60 x 30) SR    | 0828859   | 24   |

## Index

| Type                   | Order No. | Page | Type                 | Order No. | Page |
|------------------------|-----------|------|----------------------|-----------|------|
| US-EMP (60 x 30) YE    | 0828858   | 24   | US-WMT (18 x 4) VT   | 0829297   | 22   |
| US-EMP (85,6 x 54)     | 0828783   | 24   | US-WMT (18 x 4) YE   | 0828955   | 22   |
| US-EMP (85,6 x 54) SR  | 0828861   | 24   | US-WMT (23 x 4)      | 0828769   | 22   |
| US-EMP (85,6 x 54) YE  | 0828860   | 24   | US-WMT (23 x 4) BU   | 0829305   | 22   |
| US-EMSP (50 x 30)      | 0828786   | 24   | US-WMT (23 x 4) GN   | 0829306   | 22   |
| US-EMSP (50 x 30) SR   | 0828928   | 24   | US-WMT (23 x 4) OG   | 0829302   | 22   |
| US-EMSP (50 x 30) YE   | 0828927   | 24   | US-WMT (23 x 4) RD   | 0829301   | 22   |
| US-EMSP (75,6 x 54)    | 0828787   | 24   | US-WMT (23 x 4) VT   | 0829304   | 22   |
| US-EMSP (75,6 x 54) SR | 0828930   | 24   | US-WMT (23 x 4) YE   | 0828956   | 22   |
| US-EMSP (75,6 x 54) YE | 0828929   | 24   | US-WMT (30 x 4)      | 0828770   | 22   |
| US-EMSP (90 x 60)      | 0828788   | 24   | US-WMT (30 x 4) BU   | 0829312   | 22   |
| US-EMSP (90 x 60) SR   | 0828932   | 24   | US-WMT (30 x 4) GN   | 0829313   | 22   |
| US-EMSP (90 x 60) YE   | 0828931   | 24   | US-WMT (30 x 4) OG   | 0829309   | 22   |
| US-TM 100              | 0829255   | 20   | US-WMT (30 x 4) RD   | 0829308   | 22   |
| US-TMF 100             | 0829260   | 20   | US-WMT (30 x 4) VT   | 0829311   | 22   |
| US-WML 14 (25 x 19)    | 0800473   | 23   | US-WMT (30 x 4) YE   | 0828957   | 22   |
| US-WML 36 (25 x 25)    | 0800474   | 23   | US-WMTB (24 x 5)     | 0828771   | 23   |
| US-WML 6 (13 x 13)     | 0800472   | 23   | US-WMTB (24 x 5) BU  | 0829324   | 23   |
| US-WMT (10 x 4)        | 0828765   | 22   | US-WMTB (24 x 5) GN  | 0829325   | 23   |
| US-WMT (10 x 4) BU     | 0829277   | 22   | US-WMTB (24 x 5) OG  | 0829321   | 23   |
| US-WMT (10 x 4) GN     | 0829278   | 22   | US-WMTB (24 x 5) RD  | 0829320   | 23   |
| US-WMT (10 x 4) OG     | 0829274   | 22   | US-WMTB (24 x 5) VT  | 0829323   | 23   |
| US-WMT (10 x 4) RD     | 0829273   | 22   | US-WMTB (24 x 5) YE  | 0828958   | 23   |
| US-WMT (10 x 4) VT     | 0829276   | 22   | US-WMTB (29 x 8)     | 0828772   | 23   |
| US-WMT (10 x 4) YE     | 0828952   | 22   | US-WMTB (29 x 8) BU  | 0829331   | 23   |
| US-WMT (12 x 4)        | 0828766   | 22   | US-WMTB (29 x 8) GN  | 0829332   | 23   |
| US-WMT (12 x 4) BU     | 0829284   | 22   | US-WMTB (29 x 8) OG  | 0829328   | 23   |
| US-WMT (12 x 4) GN     | 0829285   | 22   | US-WMTB (29 x 8) RD  | 0829327   | 23   |
| US-WMT (12 x 4) OG     | 0829281   | 22   | US-WMTB (29 x 8) VT  | 0829330   | 23   |
| US-WMT (12 x 4) RD     | 0829280   | 22   | US-WMTB (29 x 8) YE  | 0828959   | 23   |
| US-WMT (12 x 4) VT     | 0829283   | 22   | US-WMTB (44 x 15)    | 0828773   | 23   |
| US-WMT (12 x 4) YE     | 0828953   | 22   | US-WMTB (44 x 15) BU | 0829338   | 23   |
| US-WMT (15 x 4)        | 0828767   | 22   | US-WMTB (44 x 15) GN | 0829339   | 23   |
| US-WMT (15 x 4) BU     | 0829291   | 22   | US-WMTB (44 x 15) OG | 0829335   | 23   |
| US-WMT (15 x 4) GN     | 0829292   | 22   | US-WMTB (44 x 15) RD | 0829334   | 23   |
| US-WMT (15 x 4) OG     | 0829288   | 22   | US-WMTB (44 x 15) VT | 0829337   | 23   |
| US-WMT (15 x 4) RD     | 0829287   | 22   | US-WMTB (44 x 15) YE | 0828960   | 23   |
| US-WMT (15 x 4) VT     | 0829290   | 22   | US2-TM 100           | 0829268   | 21   |
| US-WMT (15 x 4) YE     | 0828954   | 22   |                      |           |      |
| US-WMT (18 x 4)        | 0828768   | 22   |                      |           |      |
| US-WMT (18 x 4) BU     | 0829298   | 22   |                      |           |      |
| US-WMT (18 x 4) GN     | 0829299   | 22   |                      |           |      |
| US-WMT (18 x 4) OG     | 0829295   | 22   |                      |           |      |
| US-WMT (18 x 4) RD     | 0829294   | 22   |                      |           |      |

| Type                   | Order No. | Page | Type                   | Order No. | Page |
|------------------------|-----------|------|------------------------|-----------|------|
| <b>W</b>               |           |      | WMS 3,2 (60 x 5)R YE   | 0800399   | 30   |
|                        |           |      | WMS 3,2 (60 x 5)RL     | 0800384   | 30   |
|                        |           |      | WMS 38,1 (60 x 60)R    | 0800372   | 30   |
|                        |           |      | WMS 38,1 (60 x 60)R YE | 0800406   | 30   |
| WML 5 (25 x 10)R       | 0817523   | 28   | WMS 6,4 (30 x 10)R     | 0800376   | 30   |
| WML 6 (13 x 13)R       | 0816252   | 28   | WMS 6,4 (30 x 10)R YE  | 0800410   | 30   |
| WML 7,5 (17 x 9)R      | 0828444   | 28   | WMS 6,4 (60 x 10)R     | 0800367   | 30   |
| WML 14 (25 x 19)R      | 0817536   | 28   | WMS 6,4 (60 x 10)R YE  | 0800401   | 30   |
| WML 14 (25 x 19)R YE   | 0817549   | 28   | WMS 9,5 (30 x 16)R     | 0800377   | 30   |
| WML 14 (38 x 19)R      | 0817552   | 28   | WMS 9,5 (30 x 16)R YE  | 0800411   | 30   |
| WML 18 (12 x 12)R      | 0817507   | 28   | WMS 9,5 (60 x 16)R     | 0800368   | 30   |
| WML 20 (31 x 25)R      | 0828457   | 28   | WMS 9,5 (60 x 16)R YE  | 0800402   | 30   |
| WML 3 (13 x 10)R       | 0800073   | 28   | WMS 12,7 (E x 20)R     | 0800294   | 31   |
| WML 36 (25 x 38)R      | 0817510   | 28   | WMS 12,7 (E x 20)R BK  | 0800422   | 31   |
| WML 7,5 (13 x 13)R     | 0800074   | 28   | WMS 12,7 (E x 20)R YE  | 0800305   | 31   |
| WML 7,5 (25 x 13)R     | 0800075   | 28   | WMS 12,7 (E x 20)RL    | 0800325   | 31   |
| WML 12 (25 x 19)R      | 0800076   | 28   | WMS 12,7 (E x 20)RL BK | 0800432   | 31   |
| WML 22 (25 x 25)R      | 0800078   | 28   | WMS 12,7 (E x 20)RL YE | 0800333   | 31   |
| WML 46 (25 x 38)R      | 0800067   | 28   | WMS 19,1 (E x 30)R     | 0800295   | 31   |
| WMS 12,7 (60 x 20)R    | 0800369   | 30   | WMS 19,1 (E x 30)R BK  | 0800423   | 31   |
| WMS 12,7 (60 x 20)R YE | 0800403   | 30   | WMS 19,1 (E x 30)R YE  | 0800306   | 31   |
| WMS 19,1 (60 x 30)R    | 0800370   | 30   | WMS 19,1 (E x 30)RL    | 0800326   | 31   |
| WMS 19,1 (60 x 30)R YE | 0800404   | 30   | WMS 19,1 (E x 30)RL BK | 0800434   | 31   |
| WMS 2,4 (15 x 4)R      | 0800379   | 30   | WMS 19,1 (E x 30)RL YE | 0800334   | 31   |
| WMS 2,4 (15 x 4)R YE   | 0800412   | 30   | WMS 2,4 (E x 4)R       | 0800289   | 31   |
| WMS 2,4 (15 x 4)RL     | 0800389   | 30   | WMS 2,4 (E x 4)R BK    | 0800415   | 31   |
| WMS 2,4 (15 x 4)RXL    | 0800396   | 30   | WMS 2,4 (E x 4)R YE    | 0800300   | 31   |
| WMS 2,4 (30 x 4)R      | 0800373   | 30   | WMS 2,4 (E x 4)RL      | 0800319   | 31   |
| WMS 2,4 (30 x 4)R YE   | 0800407   | 30   | WMS 2,4 (E x 4)RL BK   | 0800427   | 31   |
| WMS 2,4 (30 x 4)RL     | 0800386   | 30   | WMS 2,4 (E x 4)RL YE   | 0800328   | 31   |
| WMS 2,4 (30 x 4)RXL    | 0800394   | 30   | WMS 25,4 (E x 40)R     | 0800296   | 31   |
| WMS 2,4 (60 x 4)R      | 0800363   | 30   | WMS 25,4 (E x 40)R BK  | 0800424   | 31   |
| WMS 2,4 (60 x 4)R YE   | 0800398   | 30   | WMS 25,4 (E x 40)R YE  | 0800308   | 31   |
| WMS 2,4 (60 x 4)RL     | 0800383   | 30   | WMS 25,4 (E x 40)RL    | 0800327   | 31   |
| WMS 2,4 (60 x 4)RXL    | 0800392   | 30   | WMS 25,4 (E x 40)RL BK | 0800435   | 31   |
| WMS 25,4 (60 x 40)R    | 0800371   | 30   | WMS 25,4 (E x 40)RL YE | 0800335   | 31   |
| WMS 25,4 (60 x 40)R YE | 0800405   | 30   | WMS 3,2 (E x 5)R       | 0800290   | 31   |
| WMS 3,2 (15 x 5)R      | 0800380   | 30   | WMS 3,2 (E x 5)R BK    | 0800416   | 31   |
| WMS 3,2 (15 x 5)R YE   | 0800413   | 30   | WMS 3,2 (E x 5)R YE    | 0800301   | 31   |
| WMS 3,2 (15 x 5)RL     | 0800390   | 30   | WMS 3,2 (E x 5)RL      | 0800320   | 31   |
| WMS 3,2 (30 x 5)R      | 0800374   | 30   | WMS 3,2 (E x 5)RL BK   | 0800428   | 31   |
| WMS 3,2 (30 x 5)R YE   | 0800408   | 30   | WMS 3,2 (E x 5)RL YE   | 0800329   | 31   |
| WMS 3,2 (30 x 5)RL     | 0800387   | 30   | WMS 38,1 (E x 60)R     | 0800298   | 31   |
| WMS 3,2 (60 x 5)R      | 0800364   | 30   | WMS 38,1 (E x 60)R BK  | 0800425   | 31   |



## Index

| Type                  | Order No. | Page | Type | Order No. | Page |
|-----------------------|-----------|------|------|-----------|------|
| WMS 38,1 (E x 60)R YE | 0800309   | 31   |      |           |      |
| WMS 4,8 (15 x 9)R     | 0800382   | 30   |      |           |      |
| WMS 4,8 (15 x 9)R YE  | 0800414   | 30   |      |           |      |
| WMS 4,8 (15 x 9)RL    | 0800391   | 30   |      |           |      |
| WMS 4,8 (15 x 9)RXL   | 0800397   | 30   |      |           |      |
| WMS 4,8 (30 x 9)R     | 0800375   | 30   |      |           |      |
| WMS 4,8 (30 x 9)R YE  | 0800409   | 30   |      |           |      |
| WMS 4,8 (30 x 9)RL    | 0800388   | 30   |      |           |      |
| WMS 4,8 (30 x 9)RXL   | 0800395   | 30   |      |           |      |
| WMS 4,8 (60 x 9)R     | 0800366   | 30   |      |           |      |
| WMS 4,8 (60 x 9)R YE  | 0800400   | 30   |      |           |      |
| WMS 4,8 (60 x 9)RL    | 0800385   | 30   |      |           |      |
| WMS 4,8 (60 x 9)RXL   | 0800393   | 30   |      |           |      |
| WMS 4,8 (E x 9)R      | 0800291   | 31   |      |           |      |
| WMS 4,8 (E x 9)R BK   | 0800418   | 31   |      |           |      |
| WMS 4,8 (E x 9)R YE   | 0800302   | 31   |      |           |      |
| WMS 4,8 (E x 9)RL     | 0800321   | 31   |      |           |      |
| WMS 4,8 (E x 9)RL BK  | 0800429   | 31   |      |           |      |
| WMS 4,8 (E x 9)RL YE  | 0800330   | 31   |      |           |      |
| WMS 50,8 (E x 80)R    | 0800299   | 31   |      |           |      |
| WMS 50,8 (E x 80)R BK | 0800426   | 31   |      |           |      |
| WMS 50,8 (E x 80)R YE | 0800311   | 31   |      |           |      |
| WMS 6,4 (E x 10)R     | 0800292   | 31   |      |           |      |
| WMS 6,4 (E x 10)R BK  | 0800419   | 31   |      |           |      |
| WMS 6,4 (E x 10)R YE  | 0800303   | 31   |      |           |      |
| WMS 6,4 (E x 10)RL    | 0800322   | 31   |      |           |      |
| WMS 6,4 (E x 10)RL BK | 0800430   | 31   |      |           |      |
| WMS 6,4 (E x 10)RL YE | 0800331   | 31   |      |           |      |
| WMS 9,5 (E x 16)R     | 0800293   | 31   |      |           |      |
| WMS 9,5 (E x 16)R BK  | 0800421   | 31   |      |           |      |
| WMS 9,5 (E x 16)R YE  | 0800304   | 31   |      |           |      |
| WMS 9,5 (E x 16)RL    | 0800324   | 31   |      |           |      |
| WMS 9,5 (E x 16)RL BK | 0800431   | 31   |      |           |      |
| WMS 9,5 (E x 16)RL YE | 0800332   | 31   |      |           |      |
| WMT 2,4 (15 x 4)R     | 0816281   | 29   |      |           |      |
| WMT 3,5 (15 x 5)R     | 0817222   | 29   |      |           |      |
| WMT 4,2 (15 x 6)R     | 0817235   | 29   |      |           |      |
| WMT 5,5 (15 x 8)R     | 0817248   | 29   |      |           |      |
| WMT 8,4 (17 x 10)R    | 0817251   | 29   |      |           |      |
| WMTB (24 x 8)R        | 0816278   | 29   |      |           |      |
| WMTB (35 x 15)R       | 0817316   | 29   |      |           |      |





Further information on the products presented here and on the world of solutions from Phoenix Contact can be found at [www.phoenixcontact.net/catalog](http://www.phoenixcontact.net/catalog)



Or contact us directly.



PHOENIX CONTACT GmbH & Co. KG  
32823 Blomberg, Germany  
Phone: +49 5235 3-00  
Fax: +49 5235 3-4 12 00  
[www.phoenixcontact.com](http://www.phoenixcontact.com)



## Стандарт Электрон Связь

Мы молодая и активно развивающаяся компания в области поставок электронных компонентов. Мы поставляем электронные компоненты отечественного и импортного производства напрямую от производителей и с крупнейших складов мира.

Благодаря сотрудничеству с мировыми поставщиками мы осуществляем комплексные и плановые поставки широчайшего спектра электронных компонентов.

Собственная эффективная логистика и склад в обеспечивает надежную поставку продукции в точно указанные сроки по всей России.

Мы осуществляем техническую поддержку нашим клиентам и предпродажную проверку качества продукции. На все поставляемые продукты мы предоставляем гарантию .

Осуществляем поставки продукции под контролем ВП МО РФ на предприятия военно-промышленного комплекса России , а также работаем в рамках 275 ФЗ с открытием отдельных счетов в уполномоченном банке. Система менеджмента качества компании соответствует требованиям ГОСТ ISO 9001.

Минимальные сроки поставки, гибкие цены, неограниченный ассортимент и индивидуальный подход к клиентам являются основой для выстраивания долгосрочного и эффективного сотрудничества с предприятиями радиоэлектронной промышленности, предприятиями ВПК и научно-исследовательскими институтами России.

С нами вы становитесь еще успешнее!

### Наши контакты:

**Телефон:** +7 812 627 14 35

**Электронная почта:** [sales@st-electron.ru](mailto:sales@st-electron.ru)

**Адрес:** 198099, Санкт-Петербург,  
Промышленная ул, дом № 19, литера Н,  
помещение 100-Н Офис 331