

Analog Devices Welcomes Hittite Microwave Corporation

NO CONTENT ON THE ATTACHED DOCUMENT HAS CHANGED



THIS PAGE INTENTIONALLY LEFT BLANK

GaAs PHEMT MMIC LOW NOISE AMPLIFIER, 2 - 4 GHz

Typical Applications

The HMC594LC3B is ideal for:

- Fixed Microwave
- Point-to-Multi-Point Radios
- Test & Measurement Equipment
- Radar & Sensors
- Military & Space

Functional Diagram

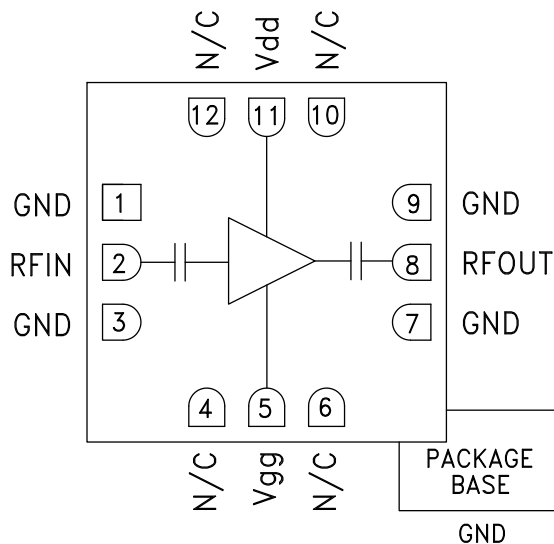

Features

- Gain Flatness: ± 0.2 dB
- Noise Figure: 3 dB
- Gain: 10 dB
- Output IP3: +36 dBm
- DC Supply: +5V @ 95mA / +6V @ 100 mA
- 50 Ohm Matched Input/Output
- RoHS Compliant 3x3 mm SMT package

General Description

The HMC594LC3B is a GaAs pHEMT MMIC Low Noise Amplifier (LNA) which operates from 2 to 4 GHz. The HMC594LC3B features extremely flat performance characteristics including 10 dB of small signal gain, 3 dB of noise figure and output IP3 of +36 dBm across the operating band. This high linearity LNA is ideal for test & measurement equipment and military assemblies due to its compact size, consistent output power and DC blocked RF I/O's. The HMC594LC3B is also available in chip form as the HMC594.

Electrical Specifications, $T_A = +25^\circ \text{C}$, $V_{dd} = +5\text{V}$, $I_{dd} = 95 \text{ mA}$, $V_{dd} = +6\text{V}$, $I_{dd} = 100\text{mA}^*$

Parameter	Min.	Typ.	Max.	Units
Frequency Range		2 - 4		GHz
Gain	7	10		dB
Gain Variation Over Temperature		0.015		dB/°C
Noise Figure		3	4	dB
Input Return Loss		15		dB
Output Return Loss		17		dB
Output Power for 1 dB Compression (P1dB)	18	21		dBm
Saturated Output Power (Psat)		22		dBm
Output Third Order Intercept (IP3)		36		dBm
Supply Current (Idd)		100	130	mA

*Adjust Vgg between -1.5V to -0.5V to achieve Idd = 100mA typical for 6V or Idd = 95mA typical for 5V.



**GaAs PHEMT MMIC LOW NOISE
AMPLIFIER, 2 - 4 GHz**

Broadband Gain & Return Loss [1]

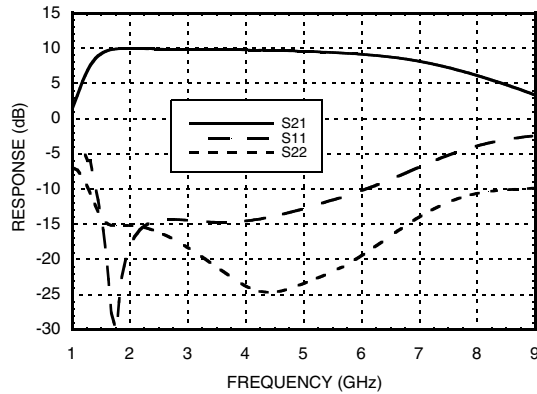

Gain vs. Temperature [1]

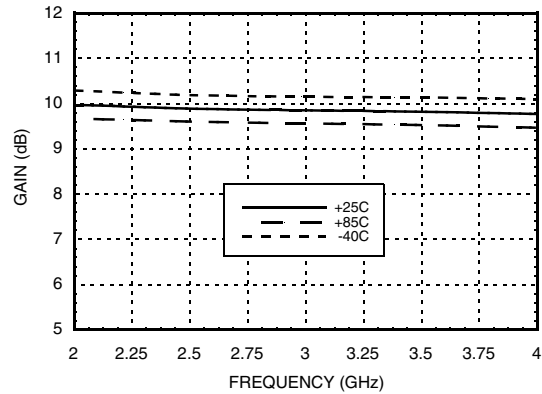

Input Return Loss vs. Temperature [1]

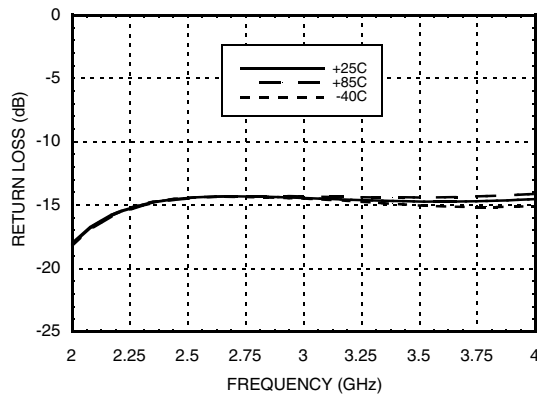

Output Return Loss vs. Temperature [1]

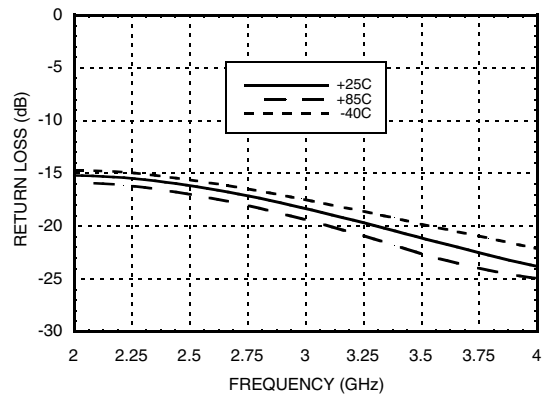

P1dB vs. Temperature [1]

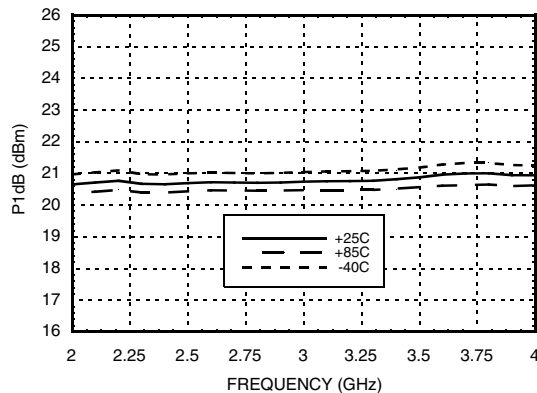

Psat vs. Temperature [1]

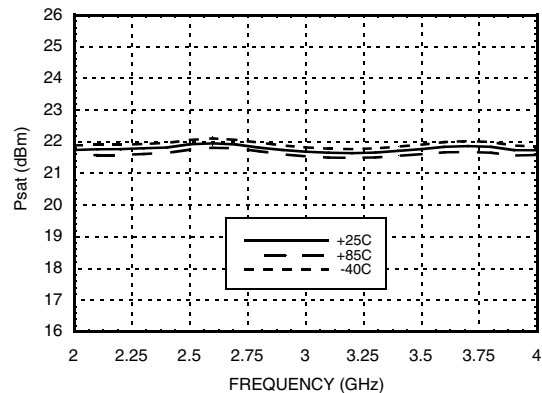

[1] Typical response for 5V and 6V Vdd



**GaAs PHEMT MMIC LOW NOISE
AMPLIFIER, 2 - 4 GHz**

AMPLIFIERS - LOW NOISE - SMT

Power Compression @ 3 GHz, 6V

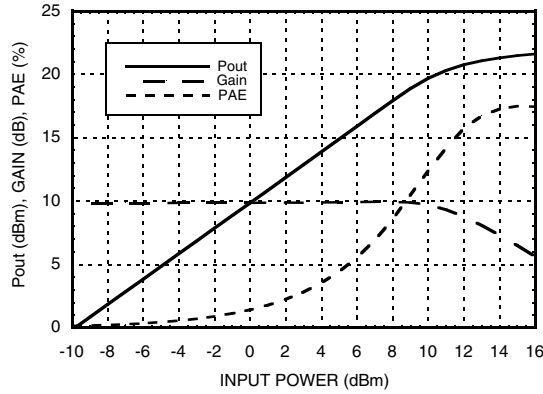

Power Compression @ 3 GHz, 5V

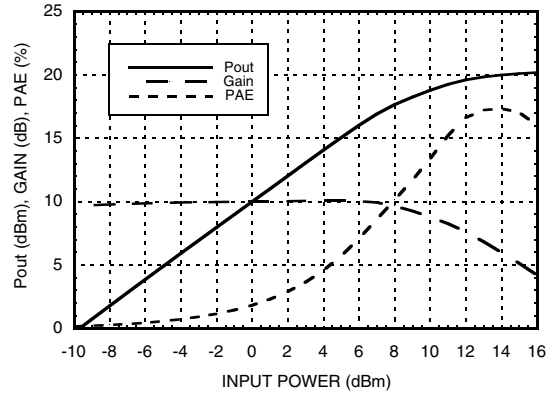

Output IP3 vs. Temperature [1]

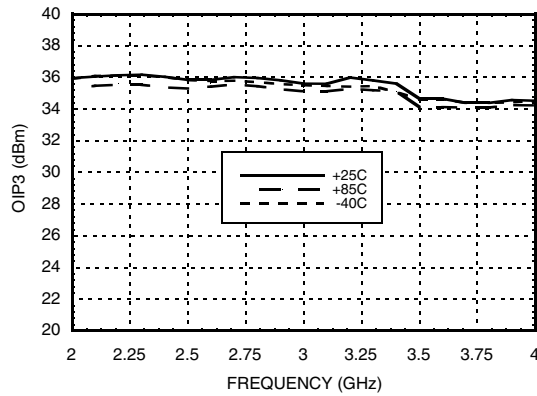

Reverse Isolation vs. Temperature [1]

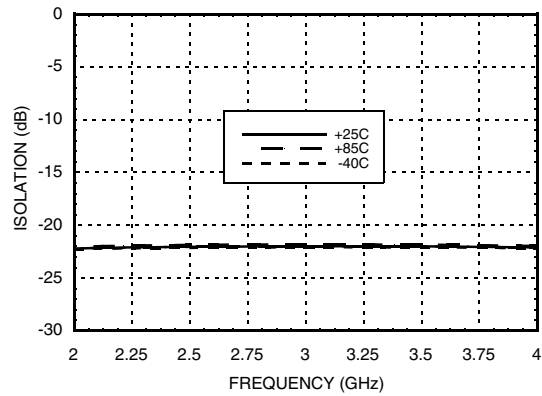

Reverse Isolation vs. Temperature [1]

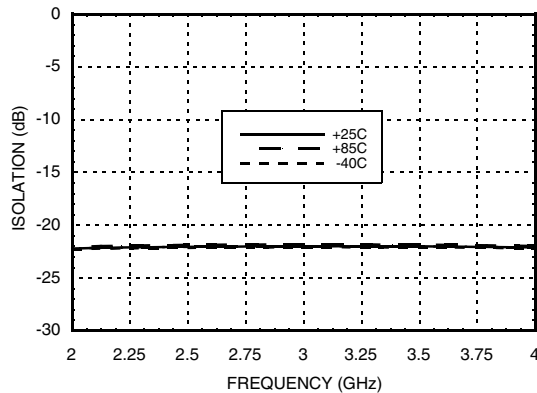

**Gain, Power & OIP3
vs. Supply Voltage @ 3 GHz**

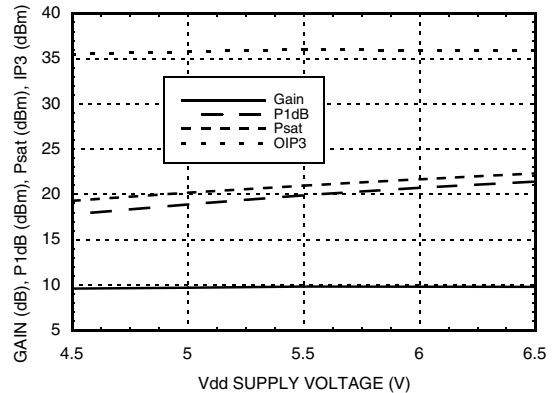

[1] Typical response for 5V and 6V Vdd

GaAs PHEMT MMIC LOW NOISE AMPLIFIER, 2 - 4 GHz

Absolute Maximum Ratings

Drain Bias Voltage (Vdd)	7V
RF Input Power (RFIN)(Vdd = +6V)	+15 dBm
Channel Temperature	175 °C
Continuous Pdiss (T = 85 °C) (derate 10 mW/°C above 85 °C)	0.9 W
Thermal Resistance (channel to ground paddle)	100 °C/W
Storage Temperature	-65 to +150 °C
Operating Temperature	-40 to +85 °C

Typical Supply Current vs. Vdd

Vdd (V)	Idd (mA)
+5.5	97
+6.0	100
+6.5	103

Note: Amplifier will operate over full voltage range shown above



ELECTROSTATIC SENSITIVE DEVICE
OBSERVE HANDLING PRECAUTIONS

Outline Drawing

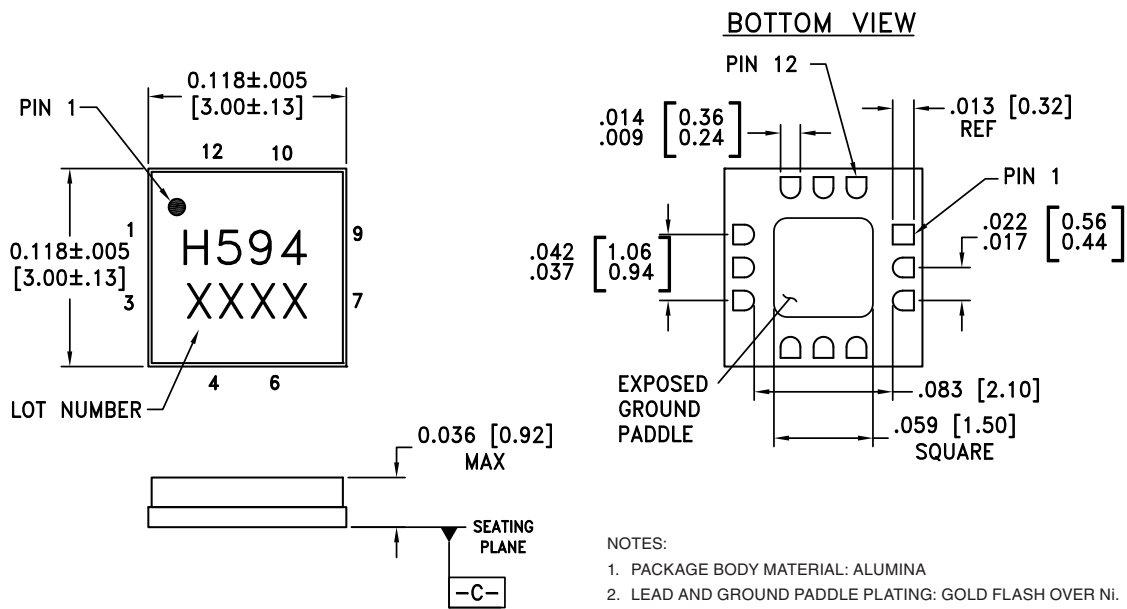

- NOTES:
1. PACKAGE BODY MATERIAL: ALUMINA
 2. LEAD AND GROUND PADDLE PLATING: GOLD FLASH OVER NI.
 3. DIMENSIONS ARE IN INCHES [MILLIMETERS].
 4. LEAD SPACING TOLERANCE IS NON-CUMULATIVE
 5. PACKAGE WARP SHALL NOT EXCEED 0.05mm.
 6. ALL GROUND LEADS AND GROUND PADDLE MUST BE SOLDERED TO PCB RF GROUND.

Package Information

Part Number	Package Body Material	Lead Finish	MSL Rating	Package Marking ^[2]
HMC594LC3B	Alumina, White	Gold over Nickel	MSL3 ^[1]	H594 XXXX

[1] Max peak reflow temperature of 260 °C

[2] 4-Digit lot number XXXX



GaAs PHEMT MMIC LOW NOISE AMPLIFIER, 2 - 4 GHz

Pin Descriptions

Pin Number	Function	Description	Interface Schematic
1, 3, 7, 9	GND	Package bottom must also be connected to RF/DC ground	
2	RFIN	This pin is AC coupled and matched to 50 Ohms.	
4, 6 10, 12	N/C	The pins are not connected internally; however, all data shown herein was measured with these pins connected to RF/DC ground externally.	
5	Vgg	Gate supply voltage for the amplifier. Adjust to achieve I _{dd} = 100mA. External bypass capacitors are required.	
8	RFOUT	This pin is AC coupled and matched to 50 Ohms.	
11	Vdd	Power Supply Voltage for the amplifier. External bypass capacitors are required.	

Application Circuit

Component	Value
C1, C4	100 pF
C2, C5	1,000 pF
C3, C6	2.2 μF

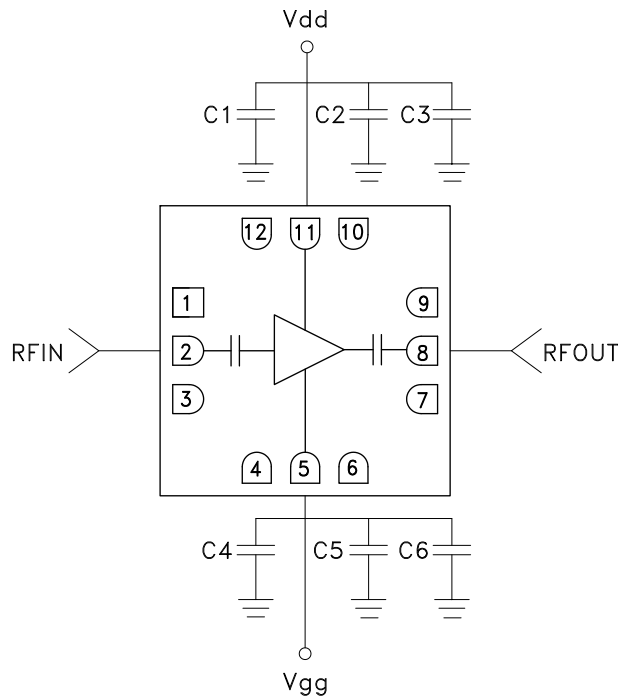

Evaluation PCB

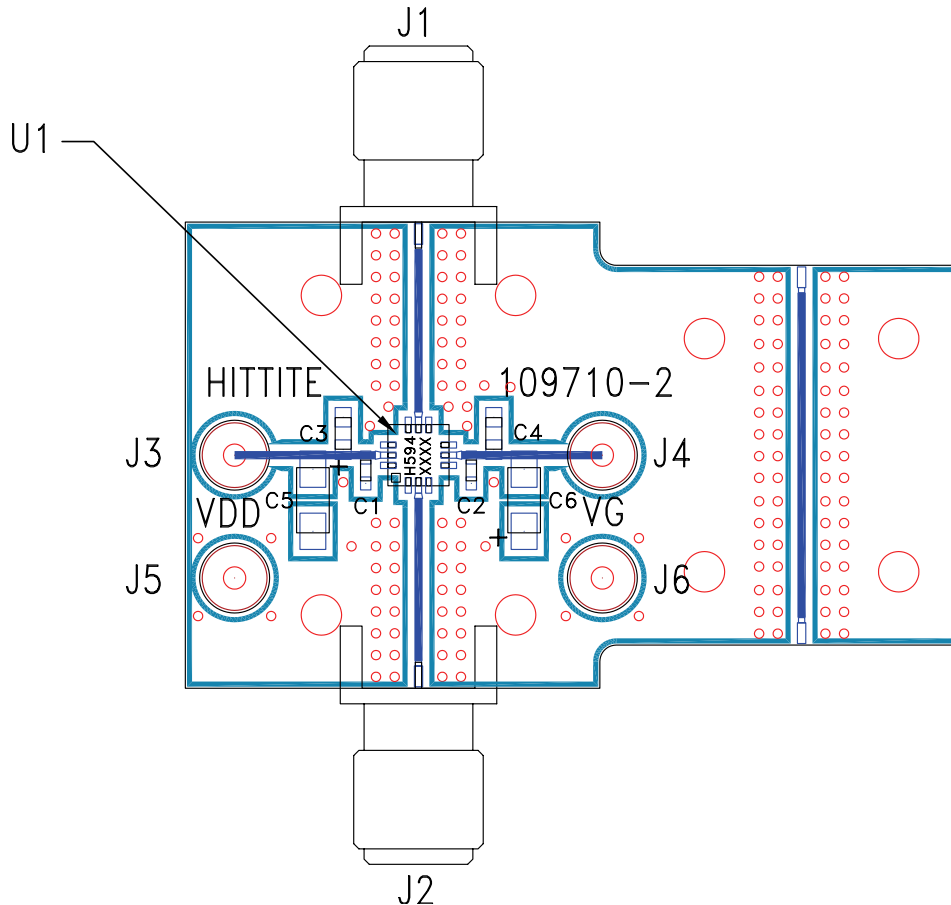

List of Materials for Evaluation PCB 109712 [1]

Item	Description
J1 - J2	SRI SMA Connector
J3 - J6	DC Pin
C1 - C2	100 pF Capacitor, 0402 Pkg.
C3 - C4	1000 pF Capacitor, 0603 Pkg.
C5 - C6	2.2 μF Capacitor, Tantalum
U1	HMC594LC3B Amplifier
PCB [2]	109710 Evaluation PCB, 10 mils

[1] Reference this number when ordering complete evaluation PCB

[2] Circuit Board Material: Rogers 4350

The circuit board used in the application should use RF circuit design techniques. Signal lines should have 50 Ohm impedance while the package ground leads and exposed paddle should be connected directly to the ground plane similar to that shown. A sufficient number of via holes should be used to connect the top and bottom ground planes. The evaluation board should be mounted to an appropriate heat sink. The evaluation circuit board shown is available from Hittite upon request.



Стандарт Электрон Связь

Мы молодая и активно развивающаяся компания в области поставок электронных компонентов. Мы поставляем электронные компоненты отечественного и импортного производства напрямую от производителей и с крупнейших складов мира.

Благодаря сотрудничеству с мировыми поставщиками мы осуществляем комплексные и плановые поставки широчайшего спектра электронных компонентов.

Собственная эффективная логистика и склад в обеспечивает надежную поставку продукции в точно указанные сроки по всей России.

Мы осуществляем техническую поддержку нашим клиентам и предпродажную проверку качества продукции. На все поставляемые продукты мы предоставляем гарантию .

Осуществляем поставки продукции под контролем ВП МО РФ на предприятия военно-промышленного комплекса России , а также работаем в рамках 275 ФЗ с открытием отдельных счетов в уполномоченном банке. Система менеджмента качества компании соответствует требованиям ГОСТ ISO 9001.

Минимальные сроки поставки, гибкие цены, неограниченный ассортимент и индивидуальный подход к клиентам являются основой для выстраивания долгосрочного и эффективного сотрудничества с предприятиями радиоэлектронной промышленности, предприятиями ВПК и научно-исследовательскими институтами России.

С нами вы становитесь еще успешнее!

Наши контакты:

Телефон: +7 812 627 14 35

Электронная почта: sales@st-electron.ru

Адрес: 198099, Санкт-Петербург,
Промышленная ул, дом № 19, литера Н,
помещение 100-Н Офис 331