

# C3D16060D

## Silicon Carbide Schottky Diode

### Z-REC™ RECTIFIER

$V_{RRM}$	=	600 V
$I_F$	=	16 A
		( $T_c < 150^\circ\text{C}$ )
$Q_c$	=	42 nC

### Features

- 600-Volt Schottky Rectifier
- Zero Reverse Recovery Current
- Zero Forward Recovery Voltage
- High-Frequency Operation
- Temperature-Independent Switching Behavior
- Extremely Fast Switching
- Positive Temperature Coefficient on  $V_F$

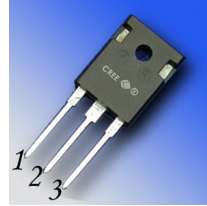

### Benefits

- Replace Bipolar with Unipolar Rectifiers
- Essentially No Switching Losses
- Higher Efficiency
- Reduction of Heat Sink Requirements
- Parallel Devices Without Thermal Runaway

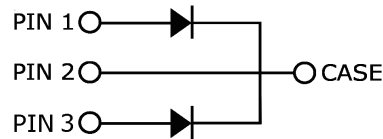

### Applications

- Switch Mode Power Supplies
- Power Factor Correction
- Solar Inverters
- Motor Drives
- Electric Vehicle Charger

Part Number	Package	Marking
C3D16060D	TO-247-3	C3D16060

### Maximum Ratings ( $T_c=25^\circ\text{C}$ unless otherwise specified)

Symbol	Parameter	Value	Unit	Test Conditions	Note
$V_{RRM}$	Repetitive Peak Reverse Voltage	600	V		
$V_{RSM}$	Surge Peak Reverse Voltage	600	V		
$V_{DC}$	DC Blocking Voltage	600	V		
$I_F$	Continuous Forward Current (Per Leg/Device)	8/16 10/20	A	$T_c < 150^\circ\text{C}$ , No AC component $T_c < 135^\circ\text{C}$ , No AC component	See Fig. 3
$I_{FRM}$	Repetitive Peak Forward Surge Current	57 36	A	$T_c = 25^\circ\text{C}$ , $t_p = 10$ ms, Half Sine Wave, $D=0.3$ $T_c = 110^\circ\text{C}$ , $t_p = 10$ ms, Half Sine Wave, $D=0.3$	
$I_{FSM}$	Non-Repetitive Peak Forward Surge Current	80 60	A	$T_c = 25^\circ\text{C}$ , $t_p = 10$ ms, Half Sine Wave, $D=0.3$ $T_c = 110^\circ\text{C}$ , $t_p = 10$ ms, Half Sine Wave, $D=0.3$	
$I_{FSM}$	Non-Repetitive Peak Forward Surge Current	220	A	$T_c = 25^\circ\text{C}$ , $t_p = 10$ $\mu\text{s}$ , Pulse	
$P_{tot}$	Power Dissipation (Per Leg)	100* 43*	W	$T_c = 25^\circ\text{C}$ $T_c = 110^\circ\text{C}$	
$T_j, T_{stg}$	Operating Junction and Storage Temperature	-55 to +175	$^\circ\text{C}$		
	TO-220 Mounting Torque	1 8.8	Nm lbf-in	M3 Screw 6-32 Screw	

\* Per Leg, \*\* Per Device

## Electrical Characteristics (Per Leg)

Symbol	Parameter	Typ.	Max.	Unit	Test Conditions	Note
$V_F$	Forward Voltage	1.6 1.9	1.8 2.4	V	$I_F = 8\text{ A}$ $T_J = 25^\circ\text{C}$ $I_F = 8\text{ A}$ $T_J = 175^\circ\text{C}$	
$I_R$	Reverse Current	10 20	50 200	$\mu\text{A}$	$V_R = 600\text{ V}$ $T_J = 25^\circ\text{C}$ $V_R = 600\text{ V}$ $T_J = 175^\circ\text{C}$	
$Q_C$	Total Capacitive Charge	21		nC	$V_R = 600\text{ V}$ , $I_F = 8\text{ A}$ $di/dt = 500\text{ A}/\mu\text{s}$ $T_J = 25^\circ\text{C}$	
C	Total Capacitance	441 39 33		pF	$V_R = 0\text{ V}$ , $T_J = 25^\circ\text{C}$ , $f = 1\text{ MHz}$ $V_R = 200\text{ V}$ , $T_J = 25^\circ\text{C}$ , $f = 1\text{ MHz}$ $V_R = 400\text{ V}$ , $T_J = 25^\circ\text{C}$ , $f = 1\text{ MHz}$	

Note:

1. This is a majority carrier diode, so there is no reverse recovery charge.

## Thermal Characteristics

Symbol	Parameter	Typ.	Unit
$R_{\theta JC}$	Thermal Resistance from Junction to Case	1.5 * 0.75 **	$^\circ\text{C}/\text{W}$

\* Per Leg, \*\* Per Device

## Typical Performance (Per Leg)

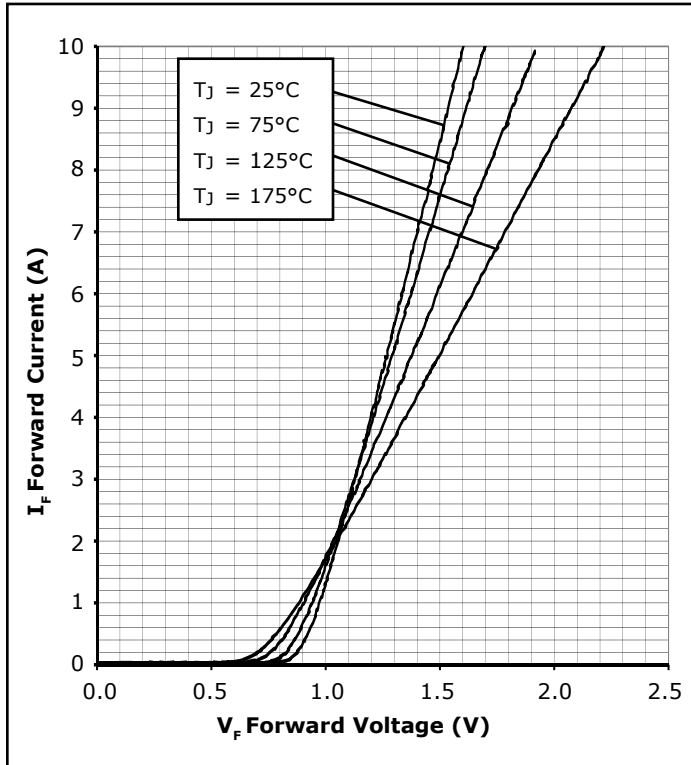

Figure 1. Forward Characteristics

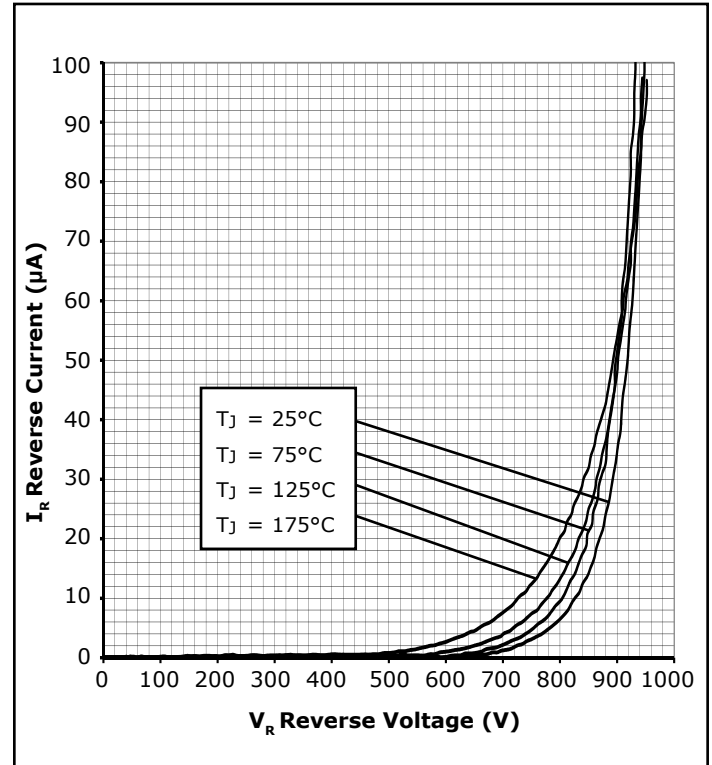

Figure 2. Reverse Characteristics

### Typical Performance (Per Leg)

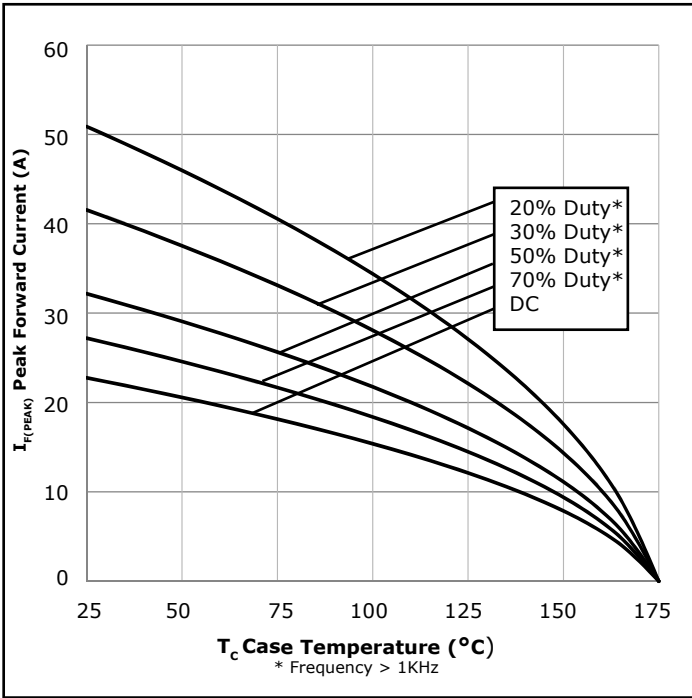

Figure 3. Current Derating

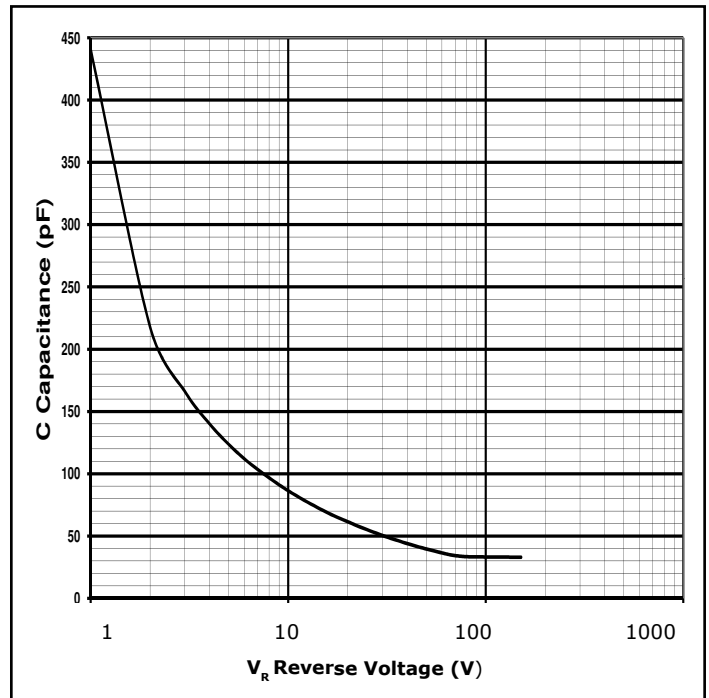

Figure 4. Capacitance vs. Reverse Voltage

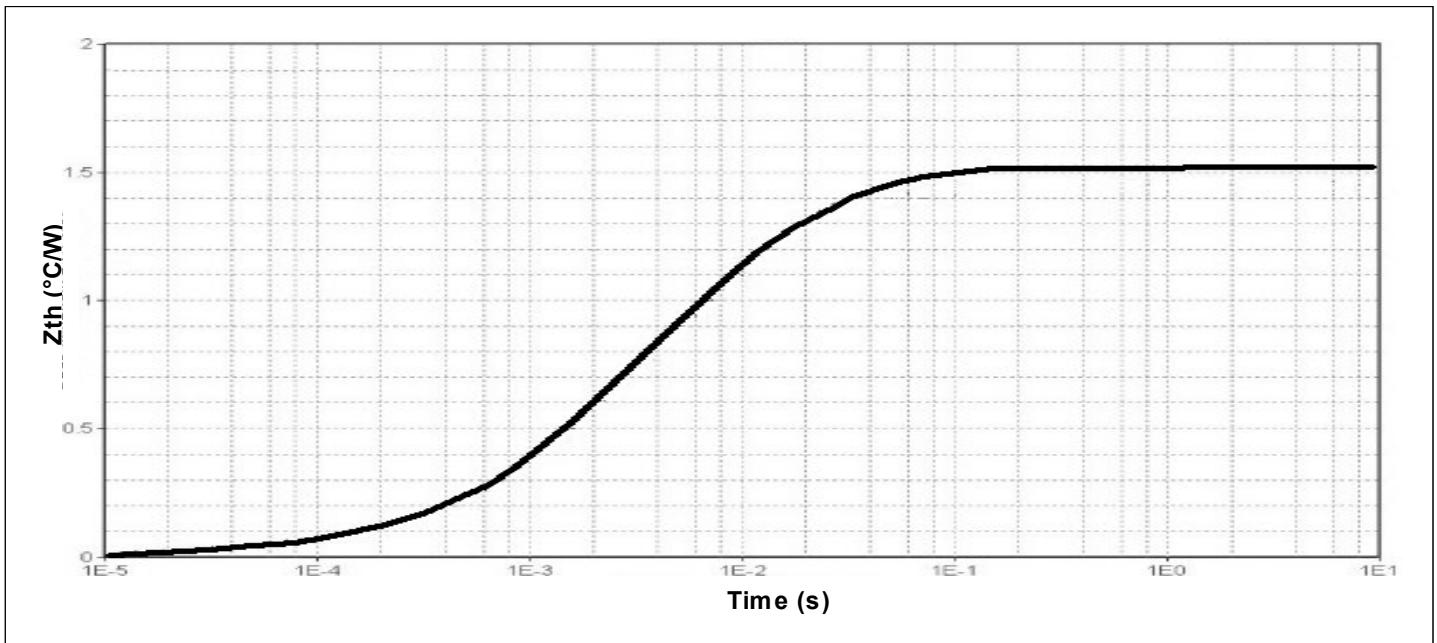

Figure 5. Transient Thermal Impedance

## Typical Performance (Per Leg)

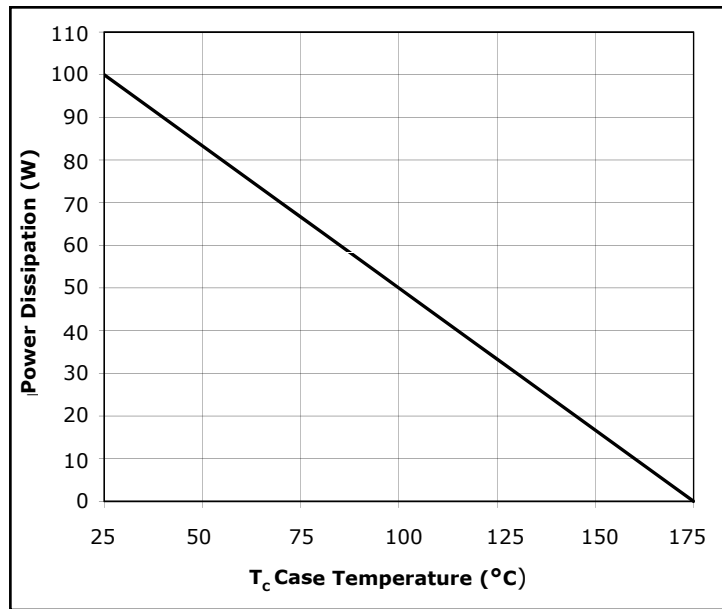
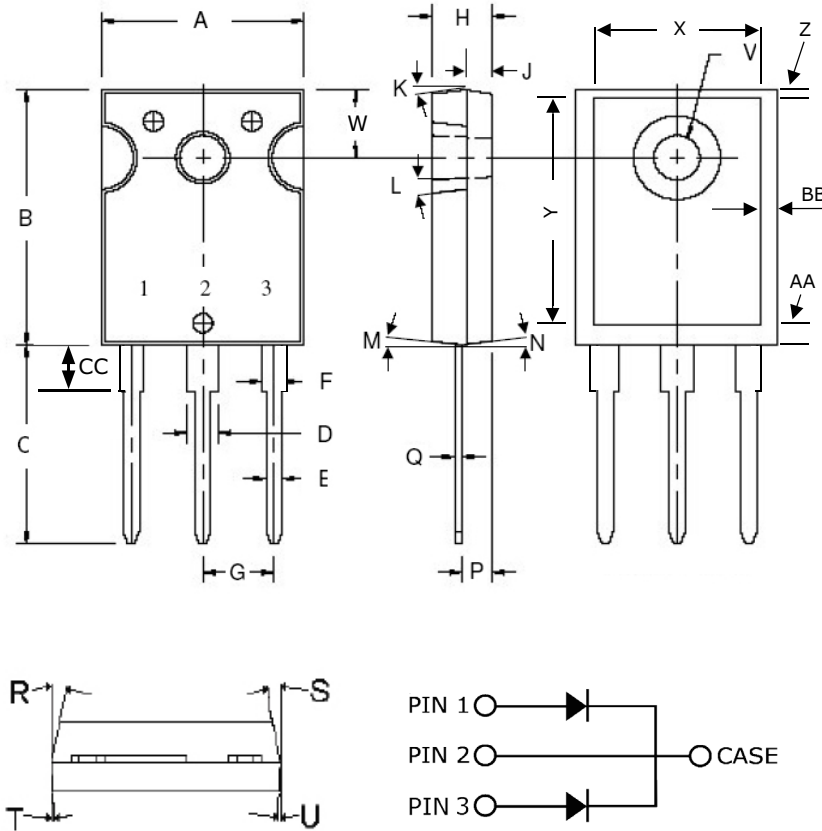

Figure 6. Power Derating

## Package Dimensions

Package TO-247-3



POS	Inches		Millimeters	
	Min	Max	Min	Max
A	.605	.635	15.367	16.130
B	.800	.831	20.320	21.10
C	.780	.800	19.810	20.320
D	.095	.133	2.413	3.380
E	.046	.052	1.168	1.321
F	.060	.095	1.524	2.410
G	.215 TYP		5.460 TYP	
H	.175	.205	4.450	5.210
J	.075	.085	1.910	2.160
K	6°	21°	6°	21°
L	4°	6°	4°	6°
M	2°	4°	2°	4°
N	2°	4°	2°	4°
P	.090	.100	2.286	2.540
Q	.020	.030	.508	.762
R	9°	11°	9°	11°
S	9°	11°	9°	11°
T	2°	8°	2°	8°
U	2°	8°	2°	8°
V	.137	.144	3.487	3.658
W	.210	.248	5.334	6.300
X	.502	.557	12.751	14.150
Y	.637	.695	16.180	17.653
Z	.038	.052	0.964	1.321
AA	.110	.140	2.794	3.556
BB	.030	.046	0.766	1.168
CC	.161	.176	4.100	4.472

## Recommended Solder Pad Layout

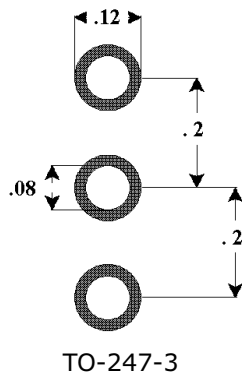

## Diode Model (Per Leg)

---

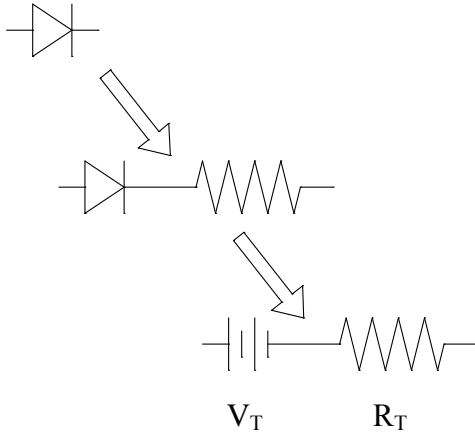

$$V_{f_T} = V_T + I_f * R_T$$

$$V_T = 0.93 + (T_j * -9.3 * 10^{-4})$$

$$R_T = 0.058 + (T_j * 5.7 * 10^{-4})$$

**Note:**  $T_j$  = Diode Junction Temperature In Degrees Celcius

"The levels of environmentally sensitive, persistent biologically toxic (PBT), persistent organic pollutants (POP), or otherwise restricted materials in this product are below the maximum concentration values (also referred to as the threshold limits) permitted for such substances, or are used in an exempted application, in accordance with EU Directive 2002/95/EC on the restriction of the use of certain hazardous substances in electrical and electronic equipment (RoHS), as amended through April 21, 2006.

This product has not been designed or tested for use in, and is not intended for use in, applications implanted into the human body nor in applications in which failure of the product could lead to death, personal injury or property damage, including but not limited to equipment used in the operation of nuclear facilities, life-support machines, cardiac defibrillators or similar emergency medical equipment, aircraft navigation or communication or control systems, air traffic control systems, or weapons systems.

Copyright © 2012 Cree, Inc. All rights reserved. The information in this document is subject to change without notice. Cree and the Cree logo are registered trademarks and Z-Rec is a trademark of Cree, Inc.

Cree, Inc.  
 4600 Silicon Drive  
 Durham, NC 27703  
 USA Tel: +1.919.313.5300  
 Fax: +1.919.313.5451  
[www.cree.com/power](http://www.cree.com/power)



**Стандарт  
Электрон  
Связь**

Мы молодая и активно развивающаяся компания в области поставок электронных компонентов. Мы поставляем электронные компоненты отечественного и импортного производства напрямую от производителей и с крупнейших складов мира.

Благодаря сотрудничеству с мировыми поставщиками мы осуществляем комплексные и плановые поставки широчайшего спектра электронных компонентов.

Собственная эффективная логистика и склад в обеспечивает надежную поставку продукции в точно указанные сроки по всей России.

Мы осуществляем техническую поддержку нашим клиентам и предпродажную проверку качества продукции. На все поставляемые продукты мы предоставляем гарантию .

Осуществляем поставки продукции под контролем ВП МО РФ на предприятия военно-промышленного комплекса России , а также работаем в рамках 275 ФЗ с открытием отдельных счетов в уполномоченном банке. Система менеджмента качества компании соответствует требованиям ГОСТ ISO 9001.

Минимальные сроки поставки, гибкие цены, неограниченный ассортимент и индивидуальный подход к клиентам являются основой для выстраивания долгосрочного и эффективного сотрудничества с предприятиями радиоэлектронной промышленности, предприятиями ВПК и научно-исследовательскими институтами России.

С нами вы становитесь еще успешнее!

**Наши контакты:**

**Телефон:** +7 812 627 14 35

**Электронная почта:** [sales@st-electron.ru](mailto:sales@st-electron.ru)

**Адрес:** 198099, Санкт-Петербург,  
Промышленная ул, дом № 19, литера Н,  
помещение 100-Н Офис 331