

±15 kV ESD protection 3 to 5.5 V low power, up to 250 kbps, RS-232 drivers and receivers

Datasheet - production data

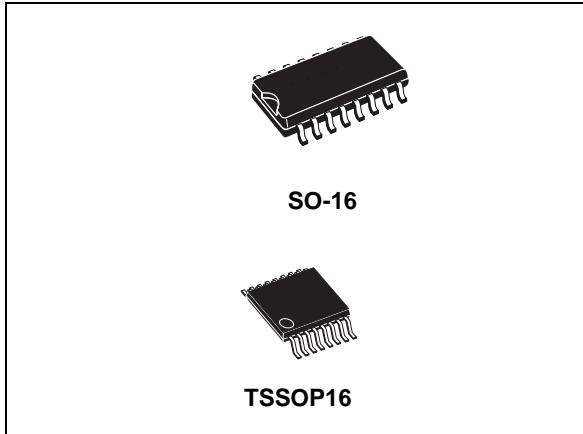

- Hand-held equipment
- Peripherals and printers

Description

The ST3232E is a 3 V powered EIA/TIA-232 and V.28/V.24 communication interfaces with low power requirements, high data-rate capabilities and enhanced electrostatic discharge (ESD) protection to ± 8 kV using IEC1000-4-2 contact discharge and ± 15 kV using the human body model. The ST3232E has a proprietary low-dropout transmitter output stage providing true RS-232 performance from 3 to 5 V supplies with a dual charge pump. The charge pump requires only four small 0.1 μF standard external capacitors for operations from 3 V supply.

The ST3232E has two receivers and two drivers.

The device is guaranteed to run at data rates of 250 kbps while maintaining RS-232 output levels.

Features

- ESD protection for RS-232 I/O pins
- ±15 kV human body model
- ±8 kV IEC 1000-4-2 contact discharge
- 300 μA supply current
- 250 kbps minimum guaranteed data rate
- 6 V/μs minimum guaranteed slew rate
- Meet EIA/TIA-232 specifications down to 3 V
- Available in SO-16 and TSSOP16

Applications

- Notebook, subnotebook and palmtop computers
- Battery-powered equipment

Table 1. Device summary

Order code	Temperature range	Package
ST3232ECDR	0 to 70 °C	SO-16 (tape and reel)
ST3232EBDR	-40 to 85 °C	SO-16 (tape and reel)
ST3232ECTR	0 to 70 °C	TSSOP16 (tape and reel)
ST3232EBTR	-40 to 85 °C	TSSOP16 (tape and reel)

Contents

1	Pin configuration	3
2	Absolute maximum ratings	4
3	Electrical characteristics	5
4	Application	7
5	Typical performance characteristics	8
6	Package information	9
6.1	SO-16 package information	10
6.2	TSSOP-16 package information	12
7	Revision history	13

1 Pin configuration

Figure 1. Pin connection

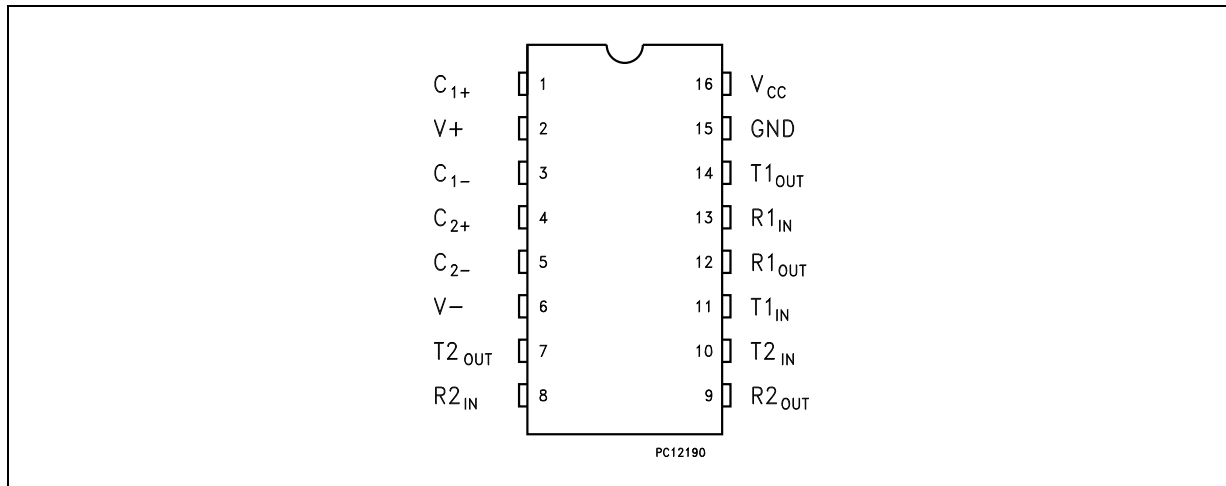

Table 2. Pin description

Pin n°	Symbol	Name and function
1	C_{1+}	Positive terminal for the first charge pump capacitor
2	$V+$	Doubled voltage terminal
3	C_{1-}	Negative Terminal for the first charge pump capacitor
4	C_{2+}	Positive terminal for the second charge pump capacitor
5	C_{2-}	Negative terminal for the second charge pump capacitor
6	$V-$	Inverted voltage terminal
7	$T2_{OUT}$	Second transmitter output voltage
8	$R2_{IN}$	Second receiver input voltage
9	$R2_{OUT}$	Second receiver output voltage
10	$T2_{IN}$	Second transmitter input voltage
11	$T1_{IN}$	First transmitter input voltage
12	$R1_{OUT}$	First receiver output voltage
13	$R1_{IN}$	First receiver input voltage
14	$T1_{OUT}$	First transmitter output voltage
15	GND	Ground
16	V_{CC}	Supply voltage

2 Absolute maximum ratings

Table 3. Absolute maximum ratings

Symbol	Parameter	Value	Unit
V _{CC}	Supply voltage	-0.3 to 6	V
V+	Doubled voltage terminal	(V _{CC} - 0.3) to 7	V
V-	Inverted voltage terminal	0.3 to -7	V
V+ + V-		13	V
T _{IN}	Transmitter input voltage range	-0.3 to 6	V
R _{IN}	Receiver input voltage range	± 25	V
T _{OUT}	Transmitter output voltage range	± 13.2	V
R _{OUT}	Receiver output voltage range	-0.3 to (V _{CC} + 0.3)	V
t _{SHORT}	Transmitter output short-to-ground time	Continuous	
T _j	Maximum junction temperature	150	°C
R _{th-jc}	Thermal resistance junction-to-case ^{(1) (2)}		°C/W
	SO-16	30	
	TSSOP16	25	
R _{th-ja}	Thermal resistance junction-to-ambient ^{(1) (2)}		
	SO-16	95	
	TSSOP16	95	

1. Short-circuits can cause excessive heating and destructive dissipation.
2. R_{th} are typical values.

Note: Absolute maximum ratings are those values beyond which damage to the device may occur. Functional operation under these condition is not implied.

Externally applied V+ and V- can have a maximum magnitude of +7 V, but their absolute addition can not exceed 13 V.

Running on internal charge pump, intrinsic self limitation allows exceeding those values without any damage.

Start-up voltage sequence (V_{CC}, then V+, then V-) is critical, therefore it is not recommended to use this device using externally applied voltage to V+ and V-.

Figure 2. ESD performance: transmitter outputs, receiver inputs

Symbol	Parameter	Test conditions	Min.	Typ.	Max.	Unit
ESD	ESD protection voltage	Human body model	±15			kV
ESD	ESD protection voltage	IEC-1000-4-2	±8			kV

3 Electrical characteristics

$C_1 - C_4 = 0.1 \mu\text{F}$, $V_{\text{CC}} = 3 \text{ V}$ to 5.5 V , $T_A = -40$ to $85 \text{ }^\circ\text{C}$, unless otherwise specified. Typical values are referred to $T_A = 25 \text{ }^\circ\text{C}$.

Table 4. Electrical characteristics

Symbol	Parameter	Test conditions	Min.	Typ.	Max.	Unit
I_{SUPPLY}	V_{CC} Power supply current	No Load, $V_{\text{CC}} = 3 \text{ V}$ or 5 V , $T_A = 25 \text{ }^\circ\text{C}$		0.3	1	mA

$C_1 - C_4 = 0.1 \mu\text{F}$, $V_{\text{CC}} = 3 \text{ V}$ to 5.5 V , $T_A = -40$ to $85 \text{ }^\circ\text{C}$, unless otherwise specified. Typical values are referred to $T_A = 25 \text{ }^\circ\text{C}$.

Table 5. Logic input

Symbol	Parameter	Test conditions	Min.	Typ.	Max.	Unit
V_{TIL}	Input logic threshold low	T-IN			0.8	V
V_{HYS}	Transmitter input hysteresis			0.25		V
V_{TIH}	Input logic threshold high	$V_{\text{CC}} = 3.3 \text{ V}$	2			V
		$V_{\text{CC}} = 5 \text{ V}$	2.4			
I_{IL}	Input leakage current	T-IN		± 0.01	± 1	μA

$C_1 - C_4 = 0.1 \mu\text{F}$ tested at $3.3 \text{ V} \pm 10 \%$, $V_{\text{CC}} = 3 \text{ V}$ to 5.5 V , $T_A = -40$ to $85 \text{ }^\circ\text{C}$, unless otherwise specified. Typical values are referred to $T_A = 25 \text{ }^\circ\text{C}$.

Table 6. Transmitter

Symbol	Parameter	Test conditions	Min.	Typ.	Max.	Unit
V_{TOUT}	Output voltage swing	All transmitter outputs are loaded with $3 \text{ k}\Omega$ to GND	± 5	± 5.4		V
R_{TOUT}	Transmitter output resistance	$V_{\text{CC}} = 0 \text{ V}$, $V_{\text{OUT}} = \pm 2 \text{ V}$	300	10M		W
I_{SC}	Output short-circuit current			± 60		mA
I_{TOL}	Output leakage current	$V_{\text{CC}} = 0 \text{ V}$ or 3.3 V to 5.5 V $V_{\text{OUT}} = \pm 12 \text{ V}$ Transmitters disable			± 25	μA

$C_1 - C_4 = 0.1 \mu\text{F}$ tested at $3.3 \text{ V} \pm 10\%$, $V_{\text{CC}} = 3 \text{ V}$ to 5.5 V , $T_A = -40$ to $85 \text{ }^\circ\text{C}$, unless otherwise specified. Typical values are referred to $T_A = 25 \text{ }^\circ\text{C}$.

Table 7. Receiver

Symbol	Parameter	Test conditions	Min.	Typ.	Max.	Unit
V_{RIN}	Receiver input voltage operating range		-25		25	V
V_{RIL}	RS-232 input threshold low	$T_A = 25 \text{ }^\circ\text{C}$, $V_{\text{CC}} = 3.3 \text{ V}$	0.6	1.1		V
		$T_A = 25 \text{ }^\circ\text{C}$, $V_{\text{CC}} = 5 \text{ V}$	0.8	1.5		
V_{RIH}	RS-232 input threshold high	$T_A = 25 \text{ }^\circ\text{C}$, $V_{\text{CC}} = 3.3 \text{ V}$		1.4	2.4	V
		$T_A = 25 \text{ }^\circ\text{C}$, $V_{\text{CC}} = 5 \text{ V}$		1.8	2.4	
V_{RIHYS}	Input hysteresis			0.5		V
R_{RIN}	Input resistance	$T_A = 25 \text{ }^\circ\text{C}$	3	5	7	k Ω
V_{ROL}	TTL/CMOS Output voltage low	$I_{\text{OUT}} = 1.6 \text{ mA}$			0.4	V
V_{ROH}	TTL/CMOS Output voltage high	$I_{\text{OUT}} = -1 \text{ mA}$	$V_{\text{CC}}-0.6$	$V_{\text{CC}}-0.1$		V

$C_1 - C_4 = 0.1 \mu\text{F}$ tested at $3.3 \text{ V} \pm 10\%$, $V_{\text{CC}} = 3 \text{ V}$ to 5.5 V , $T_A = -40$ to $85 \text{ }^\circ\text{C}$, unless otherwise specified. Typical values are referred to $T_A = 25 \text{ }^\circ\text{C}$.

Table 8. Timing characteristics

Symbol	Parameter	Test conditions	Min.	Typ.	Max.	Unit
D_{R}	Data transfer rate	$R_L = 3 \text{ k}\Omega$, $C_{L2} = 1000 \text{ pF}$ one transmitter switching	250			kbps
t_{PHLR} t_{PLHR}	Propagation delay input to output	$R_{\text{XIN}} = R_{\text{XOUT}}$, $C_L = 150 \text{ pF}$		0.15		μs
t_{OER}	Receiver output enable time	Normal operation		50		ns
t_{ODR}	Receiver output disable time	Normal operation		50		ns
$ t_{\text{PHLT}} - t_{\text{THL}} $	Transmitter propagation delay difference	(1)		200		ns
$ t_{\text{PHLR}} - t_{\text{THR}} $	Receiver propagation delay difference			50		ns
S_{RT}	Transition slew rate	$T_A = 25 \text{ }^\circ\text{C}$ $R_L = 3 \text{ k}\Omega$ to $7 \text{ k}\Omega$ $V_{\text{CC}} = 3.3 \text{ V}$ measured from $+3 \text{ V}$ to -3 V or -3 V to $+3 \text{ V}$ $C_L = 150 \text{ pF}$ to 1000 pF $C_L = 150 \text{ pF}$ to 2500 pF	6 4		30 30	V/ μs V/ μs

1. Transmitter skew is measured at the transmitter zero-cross points.

4 Application

Figure 3. Application circuits

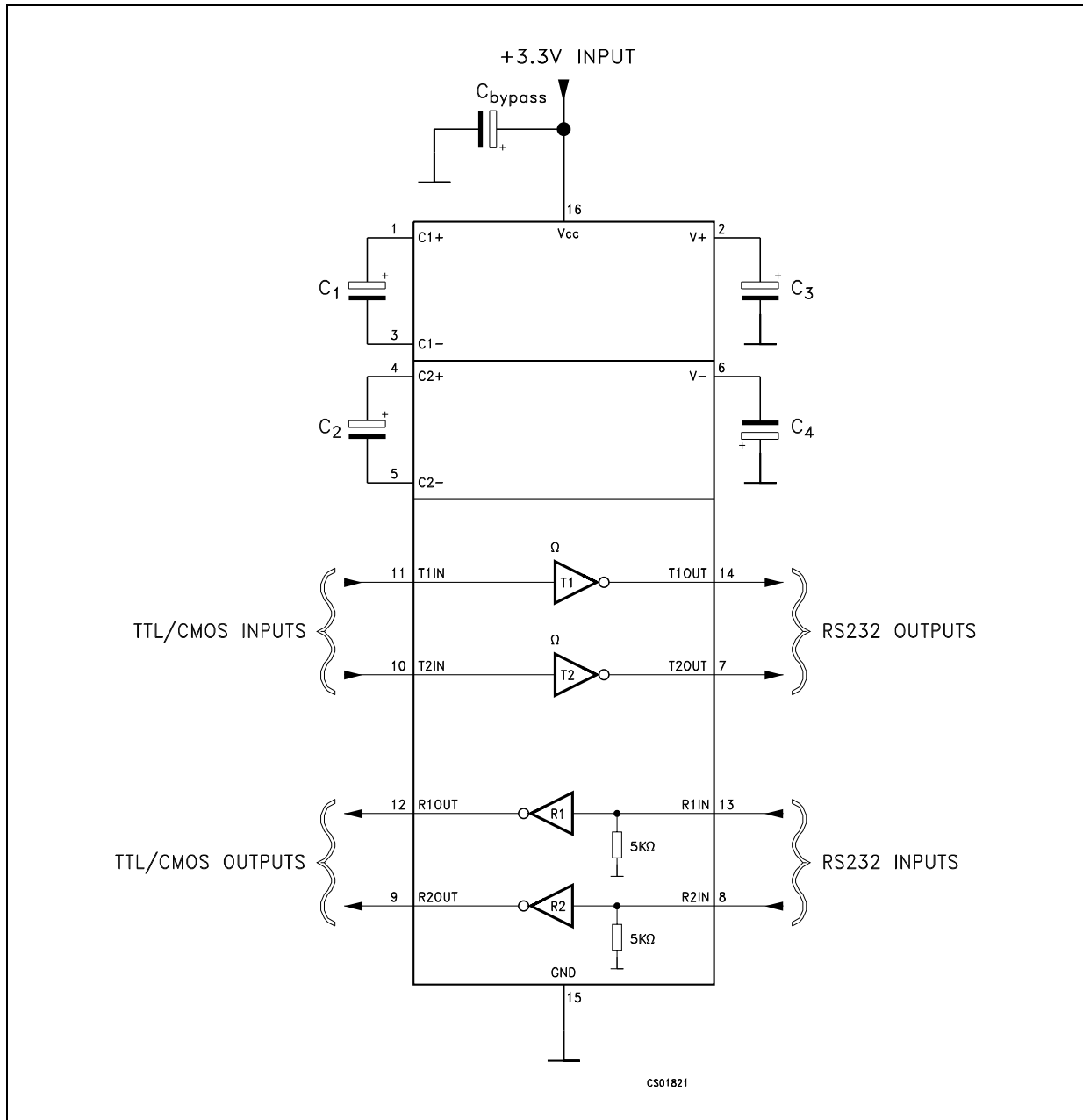

Table 9. Capacitance value (µF)

V _{CC}	C1	C2	C3	C4	C _{bypass}
3.0 to 3.6	0.1	0.1	0.1	0.1	0.1
4.5 to 5.5	0.047	0.33	0.33	0.33	0.1
3.0 to 5.5	0.1	0.47	0.47	0.47	0.1

5 Typical performance characteristics

Unless otherwise specified $T_J = 25\text{ }^\circ\text{C}$.

Figure 4. Output current vs. output high voltage **Figure 5. Output current vs. output high voltage**

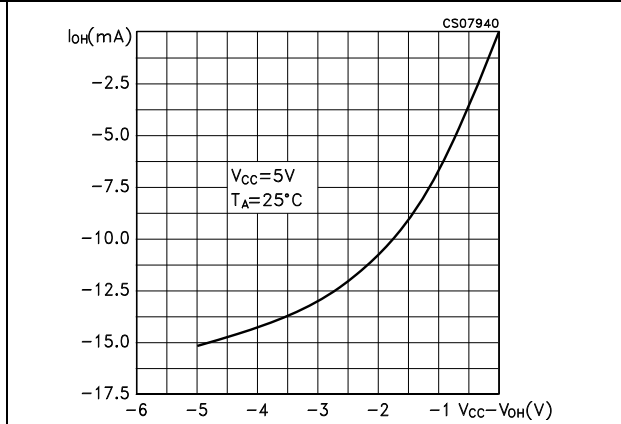
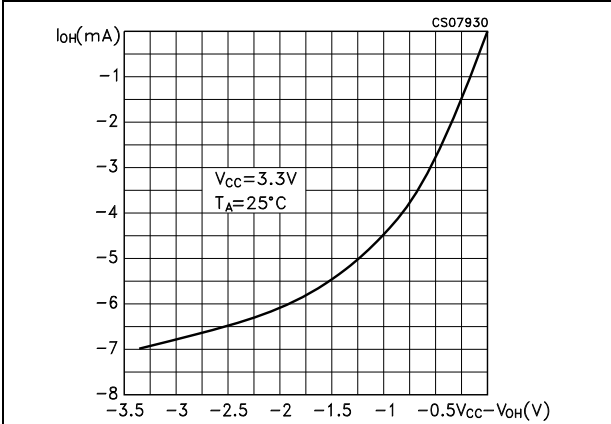

Figure 6. Output current vs. output low voltage **Figure 7. Output current vs. output low voltage**

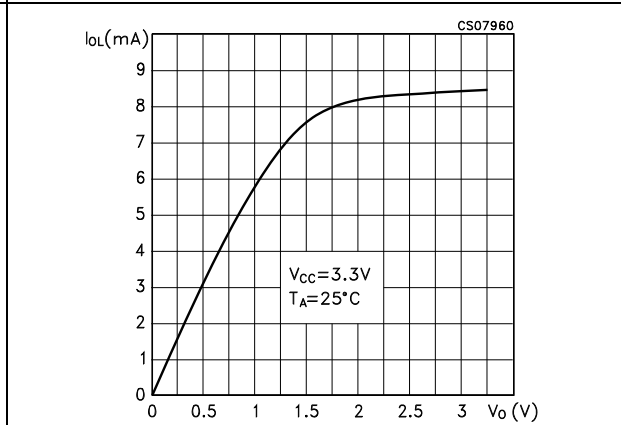
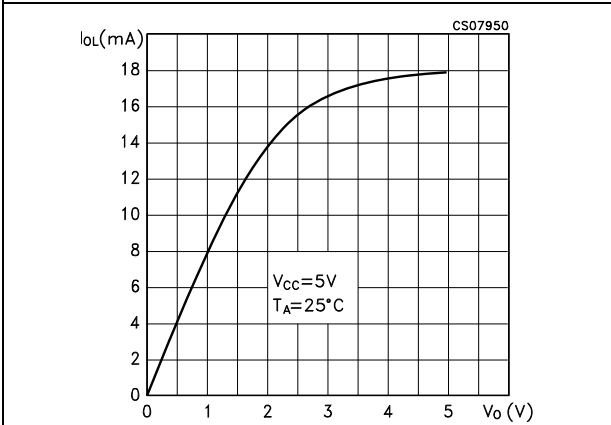

Figure 8. Voltage transfer characteristics for transmitter inputs

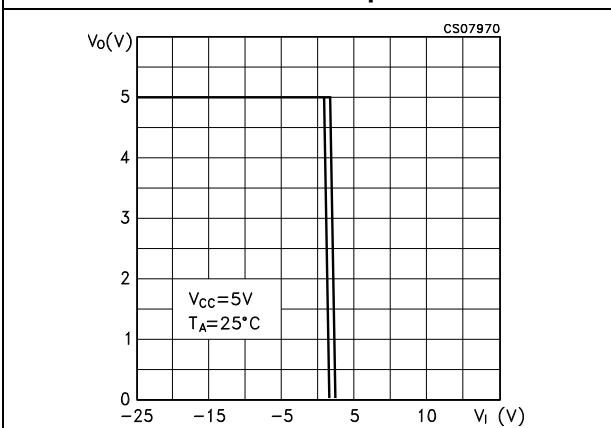
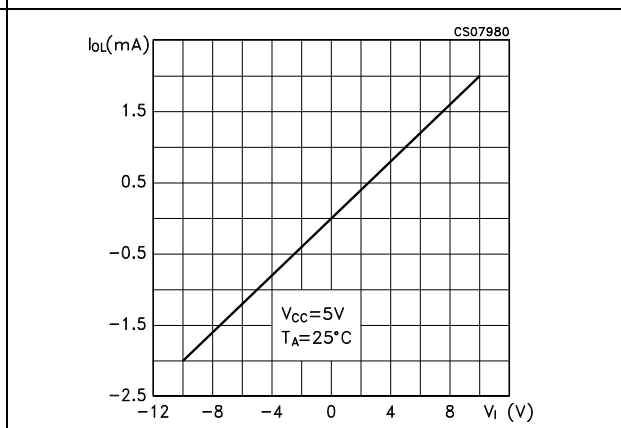

Figure 9. Receiver input resistance



6 Package information

In order to meet environmental requirements, ST offers these devices in different grades of ECOPACK[®] packages, depending on their level of environmental compliance. ECOPACK[®] specifications, grade definitions and product status are available at: www.st.com. ECOPACK[®] is an ST trademark.

6.1 SO-16 package information

Figure 10. SO-16 package outline

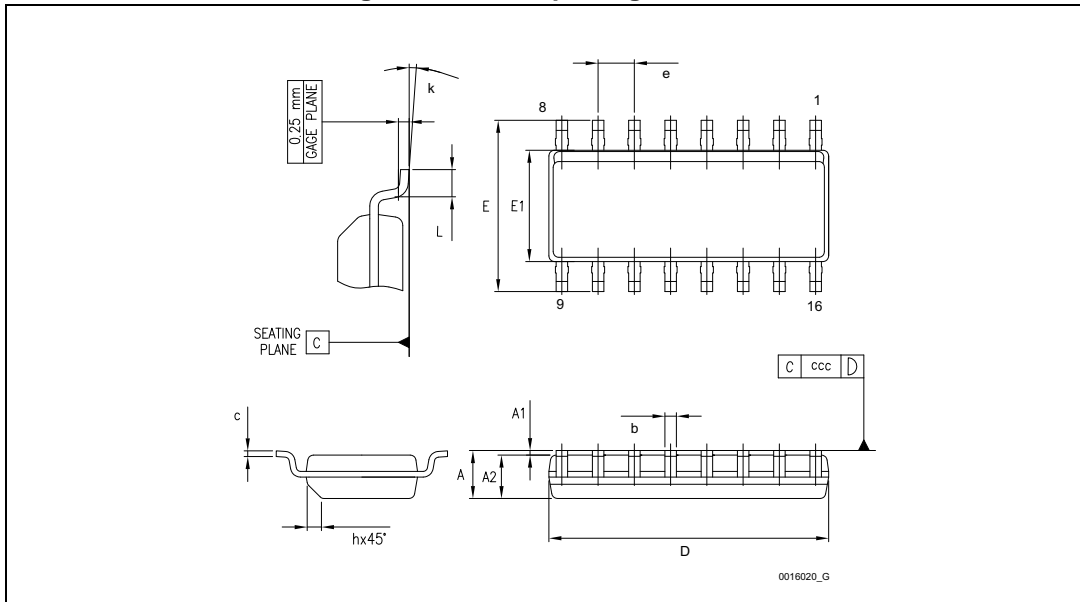

Table 10. SO-16 package mechanical data

Ref.	Dimensions (mm)		
	Min.	Typ.	Max.
A			1.75
A1	0.10		0.25
A2	1.25		
b	0.31		0.51
c	0.17		0.25
D	9.80	9.90	10.00
E	5.80	6.00	6.20
E1	3.80	3.90	4.00
e		1.27	
h	0.25		0.50
L	0.40		1.27
k	0		8
ccc			0.10

Dimension D does not include mold flash, protrusions or gate burrs. Mold flash, protrusions or gate burrs shall not exceed 0.15 mm in total (both side).

Dimension "E1" does not include interlead flash or protrusions. Interlead flash or protrusions shall not exceed 0.25mm per side.

Dimensions referred to the bottom side of the package.

Figure 11. SO-16 recommended footprint

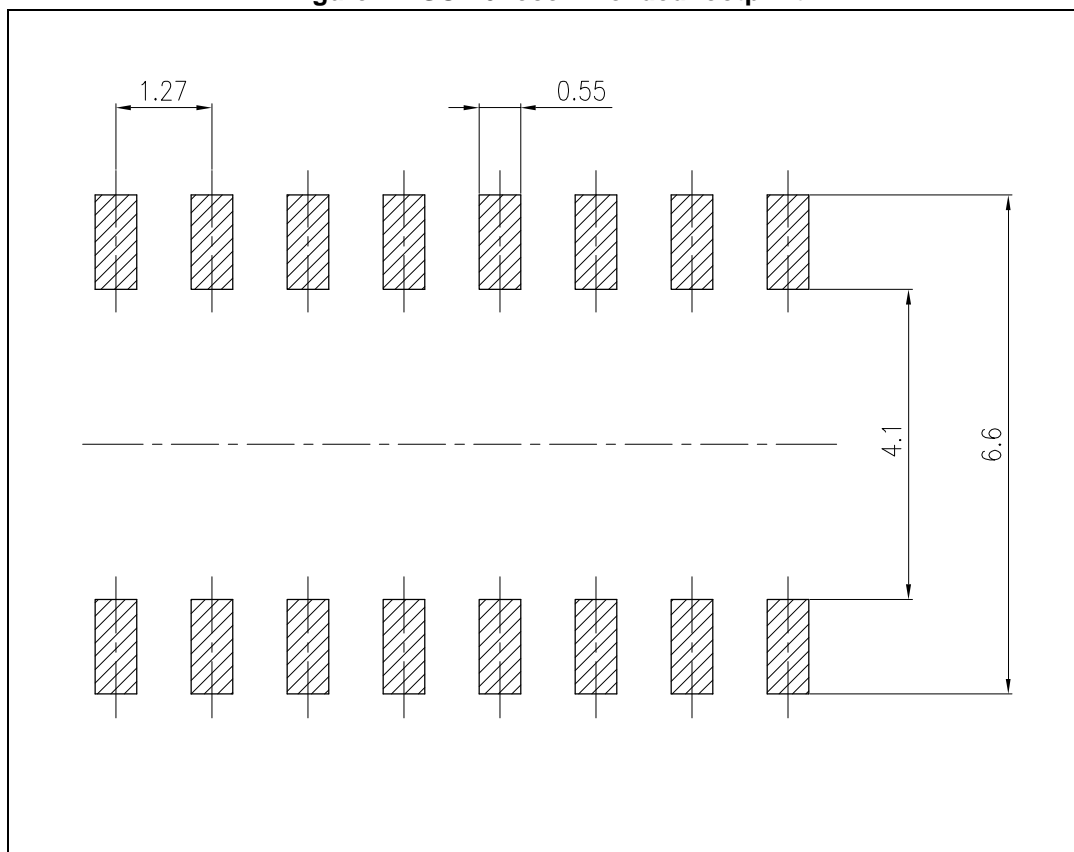

6.2 TSSOP-16 package information

Figure 12. TSSOP-16 package outline

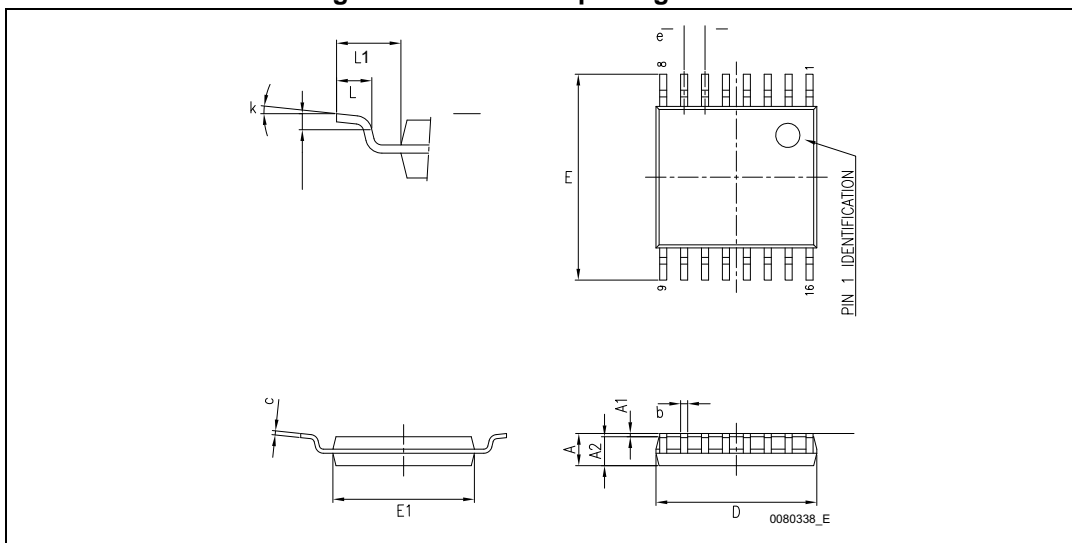

Table 11. TSSOP-16 package mechanical data

Ref.	Dimensions		
	mm		
	Min.	Typ.	Max.
A			1.20
A1	0.05		0.15
A2	0.80	1.00	1.05
b	0.19		0.30
c	0.09		0.20
D	4.90	5.00	5.10
E	6.20	6.40	6.60
E1	4.30	4.40	4.50
e		0.65	
L	0.45	0.60	0.75
L1		1.00	
k	0		8
aaa			0.10

TSSOP stands for thin shrink small outline package. Dimension “D” does not include mold flash, protrusions or gate burrs. Mold flash, protrusions or gate burrs shall not exceed 0.15 mm per side. Dimension “E1” does not include interlead flash or protrusions. Interlead flash or protrusions shall not exceed 0.25 mm per side.

7 Revision history

Table 12. Document revision history

Date	Revision	Changes
06-Sep-2006	3	Order codes updated.
21-Jan-2008	4	Added: <i>Table 1</i> and note on <i>Table 3</i> .
08-Feb-2008	5	Modified: <i>Table 1</i> on page 1.
05-Jan-2010	6	Modified: <i>Table 1</i> on page 1.
04-Jul-2018	7	Updated <i>Table 3: Absolute maximum ratings</i> and <i>Section 6: Package information</i> .

IMPORTANT NOTICE – PLEASE READ CAREFULLY

STMicroelectronics NV and its subsidiaries ("ST") reserve the right to make changes, corrections, enhancements, modifications, and improvements to ST products and/or to this document at any time without notice. Purchasers should obtain the latest relevant information on ST products before placing orders. ST products are sold pursuant to ST's terms and conditions of sale in place at the time of order acknowledgement.

Purchasers are solely responsible for the choice, selection, and use of ST products and ST assumes no liability for application assistance or the design of Purchasers' products.

No license, express or implied, to any intellectual property right is granted by ST herein.

Resale of ST products with provisions different from the information set forth herein shall void any warranty granted by ST for such product.

ST and the ST logo are trademarks of ST. All other product or service names are the property of their respective owners.

Information in this document supersedes and replaces information previously supplied in any prior versions of this document.

© 2018 STMicroelectronics – All rights reserved



Стандарт Электрон Связь

Мы молодая и активно развивающаяся компания в области поставок электронных компонентов. Мы поставляем электронные компоненты отечественного и импортного производства напрямую от производителей и с крупнейших складов мира.

Благодаря сотрудничеству с мировыми поставщиками мы осуществляем комплексные и плановые поставки широчайшего спектра электронных компонентов.

Собственная эффективная логистика и склад в обеспечивает надежную поставку продукции в точно указанные сроки по всей России.

Мы осуществляем техническую поддержку нашим клиентам и предпродажную проверку качества продукции. На все поставляемые продукты мы предоставляем гарантию .

Осуществляем поставки продукции под контролем ВП МО РФ на предприятия военно-промышленного комплекса России , а также работаем в рамках 275 ФЗ с открытием отдельных счетов в уполномоченном банке. Система менеджмента качества компании соответствует требованиям ГОСТ ISO 9001.

Минимальные сроки поставки, гибкие цены, неограниченный ассортимент и индивидуальный подход к клиентам являются основой для выстраивания долгосрочного и эффективного сотрудничества с предприятиями радиоэлектронной промышленности, предприятиями ВПК и научно-исследовательскими институтами России.

С нами вы становитесь еще успешнее!

Наши контакты:

Телефон: +7 812 627 14 35

Электронная почта: sales@st-electron.ru

Адрес: 198099, Санкт-Петербург,
Промышленная ул, дом № 19, литера Н,
помещение 100-Н Офис 331