

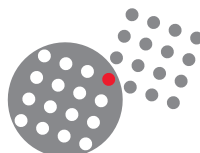

Clipper

Industrial Plastic Connectors



SOURIAU
Connection Technology



SOURIAU

Connectors and interconnect systems for harsh environments

The company designs, manufactures and markets high performance interconnect solutions for severe environments from industrial broadband and universal ranges to complex system with integrated functions:

filtering, high speed data transmission, hermetic seal, separation mechanism, remote handling, underwater mating, ...



Industrial



Aeronautical



Equipment & system

The dedicated end markets for SOURIAU's products are aeronautical, defense-space and industrial.



Railway
Geophysics
Manufacturing environment
Instrumentation
Automation & process



Civil & military aircraft
Helicopter
Weapon delivery system
Avionics



Military marine
Communications
Satellites
Launcher & missile

SOURIAU was established in 1917 and has been created by successive acquisitions of the industrial, aeronautical, defense and space activities of SOURIAU, JUPITER and BURNDY.

The Group's products are engineered and manufactured in the USA and Dominican Republic, Europe and Morocco, Japan and India, and sold by a worldwide sales and marketing organization, and in addition to SOURIAU's offices, a large network of licensed distributors and agents.

SOURIAU complies with most of national and international Quality Assurance Standards, production unit with ISO 14001.

**Quality Certificate
Management System**

ISO 9001

**Environment Certificate
Management System**

ISO 14001

**Quality Certificate
Management System**

Aeronautic Industry : EN 9100

Clipper Industrial Plastic Connectors



Contents

<i>Description/Features/Presentation</i>	4
<i>Square flange receptacle and in-line receptacle</i>	5
<i>Plug and backnut</i>	6
<i>Electrical thread backshell</i>	7
<i>Accessories</i>	8
<i>Stamped and formed contacts</i>	9
<i>Machined contacts</i>	10
<i>IP68 configuration</i>	11
<i>IP67 configuration</i>	13
<i>Mated and unmated connectors (with backshells) overall dimensions</i>	16
<i>Dimensions (receptacle and plug)</i>	17
<i>Manual crimping tool</i>	18
<i>Automatic crimping tool</i>	19
<i>Panel mounting/panel cut-out</i>	20
<i>Wiring instruction</i>	21
<i>Assembly instruction</i>	22
<i>General technical information</i>	24

Clipper Industrial Plastic Connectors

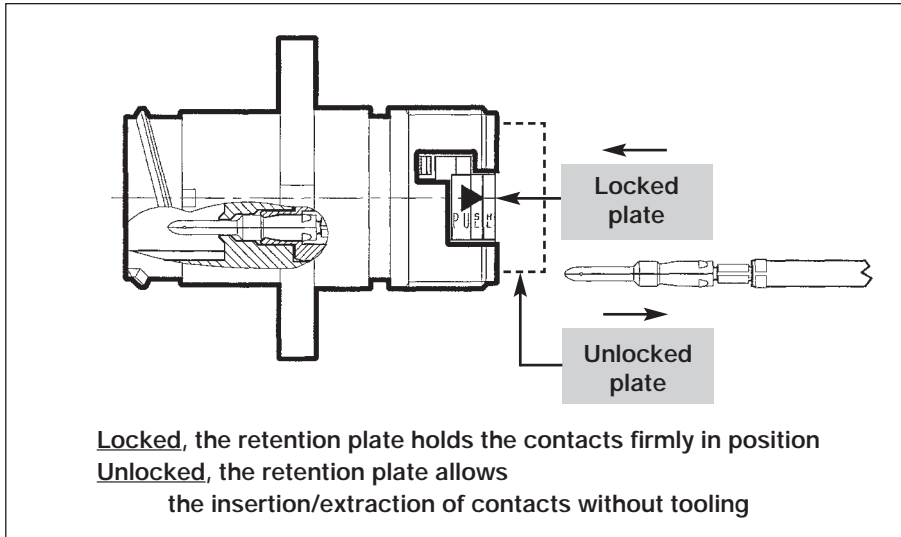

Description

Retention plate principle

Features

Mechanical

- Monobloc shell and insulator in thermoplastic material self-extinguishing to UL 94 V0.
- 180° screw coupling with positive audible safety latch.
- Scoop proof.
- Copper alloy contacts, machined or stamped and formed
- plating : gold on active part over nickel.
- Mechanical endurance :
 - connector : 250 cycles mating / unmating,
 - retention plate : 50 cycles mating / unmating.
- Retention force :
 - # 20 → 70 N
 - # 16 → 90 N.
- Vibration :
 - frequency range : 10-2000 Hz, 20 g
 - 10 cycles in accordance with CEI 68-2-6

Electrical

- Withstand voltage : 1500 Vrms min or in accordance with DIN 57110b.
- Contact resistance < 10 mW.
- Current rating per contact :
 - machined contacts :
 - # 20 (7 Amps), # 16 (13 Amps)
 - stamped and formed contacts :
 - # 20 (5 Amps), # 16 (10 Amps).

Environmental

- Sealing :
 - up to IP68
- Working temperature :
 - 40°C to +125°C. (-40°F to +257°F)
- Resistance to salt spray :
 - 48 h min
 - > 1000 h (sealed mated connectors).
- Resistance to fluids :
 - oil,
 - petrol, fuel,
 - lubricants
 - other fluids : consult us.

Presentation

CLIPPER is a plastic low cost range of industrial connectors, UL & CSA approved.

Complementing SOURIAU product range CLIPPER offers :

- a high sealing level :
 - IP67 for the sealed plug (with o'ring and mating seal)
 - IP68 for the enhanced sealed plug (with o'ring and a special mating seal). This version allows a permanent waterproof level when immersed at depths down to 30 meters.
- a retention plate system allowing insertion/extraction of the contacts without the need for tooling,
- facilities to use trade backshells with the electrical thread adaptor (PG).





CLIPPER range is composed of :

- 4 sizes of shell in molded black thermoplastic material (size 1/2/3/4).
- 7 contact layouts (4/9/14/18/26/31/40 contacts).
- #20, #16 contacts, machined or stamped and formed, crimp, solder or PC tail termination.
- An adaptor with electrical PG thread for PG backshells.
- Backnut with grommet facilities.

Clipper Industrial Plastic Connectors

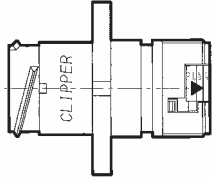
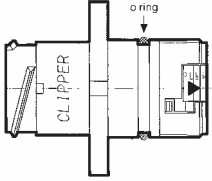
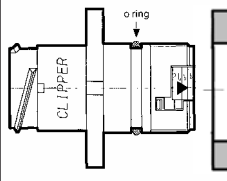
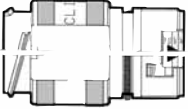

Available Style Square flange receptacle and in-line receptacle

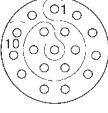
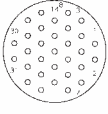
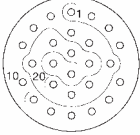
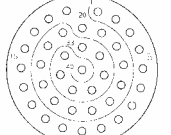
Contacts layouts		Part number								
		Unsealed receptacle (without o'ring)		Sealed receptacle (with o'ring) for use with backshell		Sealed receptacle (with o'ring and panel gasket)		In-line receptacle		
						for male contacts	for female contacts	for male contacts	for female contacts	unsealed for male contacts
Shell sizes	1	4 cts # 16 	CL1M1100	CL1R1100	CL1M1101	CL1R1101	CL1M1102	CL1R1102	CL1C1100	CL1C1101
		9 cts # 20 	CL1M1200		CL1M1201		CL1M1202		CL1C1200	CL1C1201
	2	9 cts # 16 	CL1M2100	CL1R2100	CL1M2101	CL1R2101	CL1M2102	CL1R2102	CL1C2100	CL1C2101
		14 cts # 20 	CL1M2200		CL1M2201		CL1M2202		CL1C2200	CL1C2201
	3	18 cts # 16 	CL1M3100	CL1R3100	CL1M3101	CL1R3101	CL1M3102	CL1R3102	CL1C3100	CL1C3101
		31 cts # 20 	CL1M3200		CL1M3201		CL1M3202		CL1C3200	CL1C3201
	4	26 cts # 16 	CL1M4100		CL1M4101		CL1M4102		CL1C4100	CL1C4101
		40 cts # 16 	CL1M4200	CL1R4200	CL1M4201	CL1R4201	CL1M4202	CL1R4202	CL1C4200	CL1C4201

Clipper Industrial Plastic Connectors



Plug and backnut

		Plug types without contacts	Part number							
			Unsealed plug (without o'ring and mating seal)		Sealed plug (with o'ring and mating seal)		Sealed backnut		Unsealed backnut	
			for male contacts	for female contacts	for male contacts	for female contacts	for male contacts	for female contacts	for male and female contacts	
Shell sizes	1	4 cts # 16		CL1P1100	CL1F1100	CL1P1101	CL1F1101 CL1F1103 (IP68)	CL111102	CL111101	CL111000
		9 cts # 20			CL1F1200		CL1F1201 (IP67) CL1F1203 (IP68)	CL111202	CL111201	
	2	9 cts # 16		CL1P2100	CL1F2100	CL1P2101	CL1F2101 (IP67) CL1F2103 (IP68)	CL112102	CL112101	CL112000
		14 cts # 20			CL1F2200		CL1F2201 (IP67) CL1F2203 (IP68)			
	3	18 cts # 16		CL1P3100	CL1F3100	CL1P3101	CL1F3101 (IP67) CL1F3103 (IP68)	CL113102	CL113101	CL113000
		31 cts # 20			CL1F3200		CL1F3201 (IP67) CL1F3203 (IP68)	CL113202	CL113201	
	4	26 cts # 16			CL1F4100		CL1F4101 (IP67) CL1F4103 (IP68)	CL114102	CL114101	CL114000
		40 cts # 16		CL1P4200	CL1F4200	CL1P4201	CL1F4201 (IP67) CL1F4203 (IP68)	CL114202	CL114201	

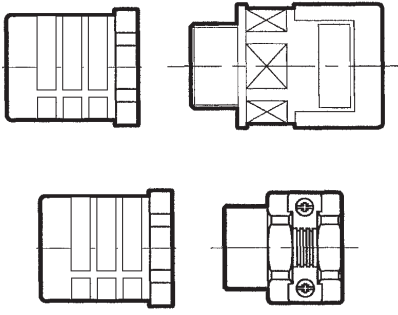
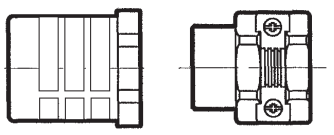

Electrical thread backshells (PG)

Unsealed (IP40)					
Description	Part numbers				
	1	2	3	4	
	(PG 13,5)	(PG 16)	(PG 21)	(PG 36)	(PG 36)
	CL101040	CL102040	CL103040	CL124040	CL104040
	CL101030	CL102030	CL103030	CL124030	-
	CL101030	CL102030	CL103030	CL124030	-
	CL101040	CL102040	CL103040	CL124040	CL104040

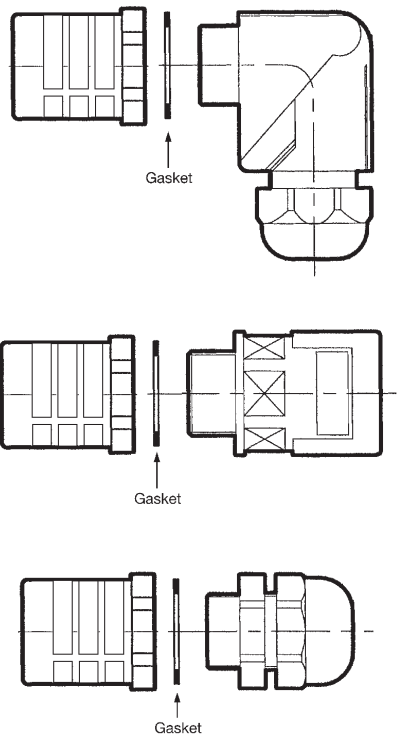
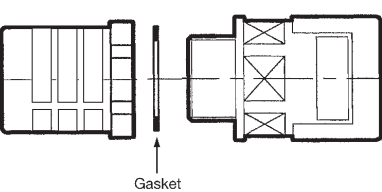
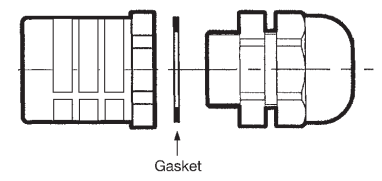
Sealed					
Description	Part numbers				
	1	2	3	4	
	(PG 13,5)	(PG 16)	(PG 21)	(PG 36)	(PG 36)
	CL101051	CL102051	CL103051	CL124051	-
	CL101041	CL102041	CL103041	CL124041	CL104041
	CL101021	CL102021	CL103021	CL124021	CL104021

Note : Electrical thread backshells are always supplied complete with the adaptor.

Clipper Industrial Plastic Connectors



Accessories

Panel gasket (for square flange receptacle)

Shell sizes	1	2	3	4
Part numbers	CL191001	CL192001	CL193001	CL194001

90° adaptors for receptacles

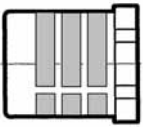

Shell sizes	1	2	3	4
Part numbers	CL131001	CL132001	CL133001	CL134001

90° adaptors for receptacles

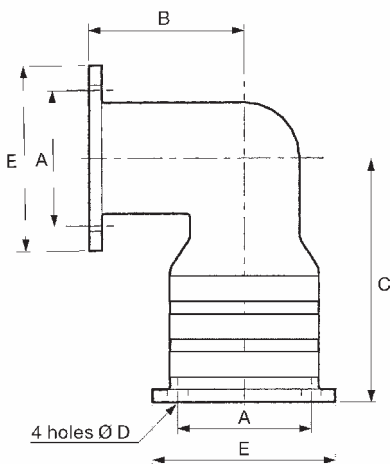

Dim. (inches) / Shell sizes	A	B	C	D	E
1	.84	.96	1.52	.13	1.15
2	.97	1.10	1.56	.13	1.21
3	1.12	1.20	1.69	.15	1.40
4	1.44	1.55	1.95	.15	1.87

90° sealed adaptors for receptacles Shell 1 to 4

Shell	Part numbers
	Sealed*
1	CL131001
2	CL132001
3	CL133001
4	CL134001

* with panel gasket

IP67 Dust cap for receptacle

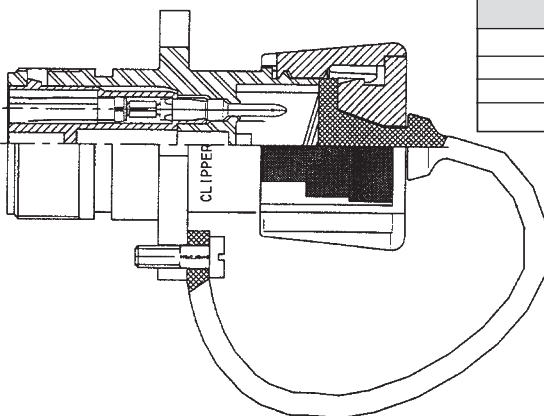





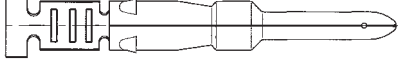

Shell	Part number
1	CL141001
2	CL142001
3	CL143001
4	CL144001

Clipper Industrial Plastic Connectors

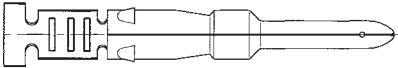

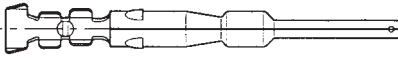
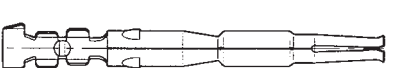
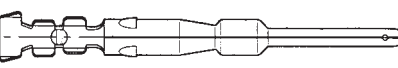
Stamped and formed contacts

Packaging	Crimp Contact with strain relief		Part numbers	Size	Ø mm over insulation (inches)	AWG	Admissible section mm ²
Bulk		male	CF16PC10RF	16	2 mm to 3 mm (0.08" to 0.12")	18 to 16	0.7 to 1.5 mm ²
		female	CF16SC10RF				
Reel 5,000 pcs.		male	CF16PC18RF				
		female	CF16SC18RF				
Bulk		male	CF10PC10RF	20	1.2 mm to 2.1 mm (0.05" to 0.08")	22 to 20	0.35 to 0.6 mm ²
		female	CF10SC10RF				
Reel 5,000 pcs.		male	CF10PC18RF				
		female	CF10SC18RF				

Plating RF : gold flash on active part for standard version (For other platings, consult FCI)

Assembly



Filler plug # 16
(for un-used contact cavities)

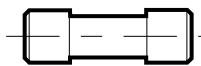

Part number : 8500 479 CL

Filler plug # 20
(for un-used contact cavities)



Part number : 8500 4144

Polarization Contact
(instruction for polarizing connector - see page 23)



Part number : CP16SW9700



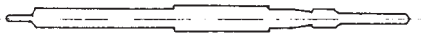

Print Circuit (PC) Tail Machined Contact

Bulk		male	16			CM16PT10LY
		male	20			CM10PT10LY

Clipper Industrial Plastic Connectors

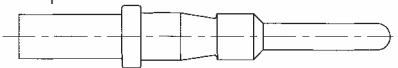
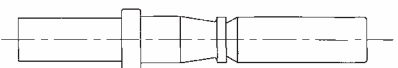
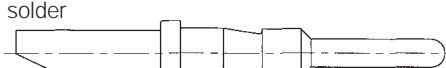
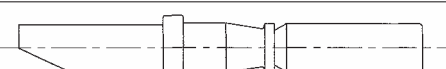

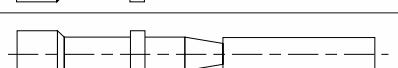
Machined contacts

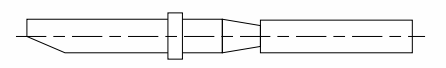
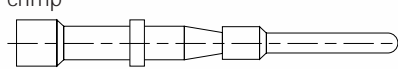
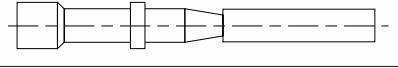
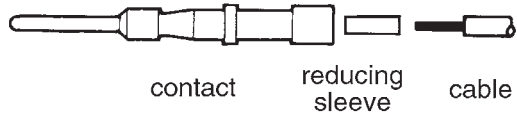
Packaging	Contact types	Part numbers	Size	Ø mm over insulation (inches)	AWG	Admissible section mm ²
Bulk	crimp 	male CM16PC10MQ	16	2 mm to 3 mm (0.08" to 0.12")	18 to 14	0.93 to 1.91 mm ²
		female CM16SC10MQ				
	solder 	male CM16PS10MQ			14* Max	
		female CM16SS10MQ				
	crimp 	male CM10PC10MQ	20	1.2 mm to 2.1 mm (0.05" to 0.08")	24 to 18	0.21 to 0.93 mm ²
		female CM10SC10MQ				
	solder 	male CM10PS10MQ			18 Max	
		female CM10SS10MQ				
	crimp 	male CM16PC00MQ	16	2 mm to 3 mm (0.08" to 0.12")	18 to 13	0.93 to 2.60 mm ²
		female CM16SC00MQ				
	male CM16PC20MQ	16	2 to 3 mm (0.08" to 0.12")	20	0.21 to 0.60 mm ²	
	female CM16SC20MQ					
	male CM10PC20MQ	20	1.2 to 2.1 mm (0.05" to 0.08")	30 to 24	0.06 to 0.21 mm ²	
	female CM10SC20MQ					

Plating MQ : 0.4µ mm gold on active part (.016µ inches) * Up to 1.91 mm²

Extended ground contact-crimp (Length + .039 inch = +1 mm)

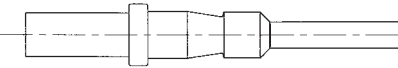
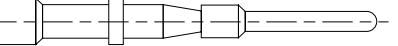
Bulk		male	16	0.08" to 0.12"	18 to 14	8501 9641
		male	20	0.05" to 0.08"	24 to 18	8501 9642 CL

Clipper Industrial Plastic Connectors



IP68 Configuration



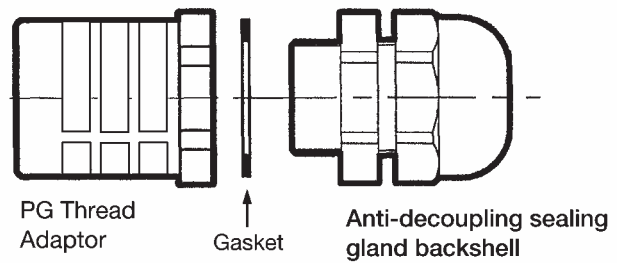
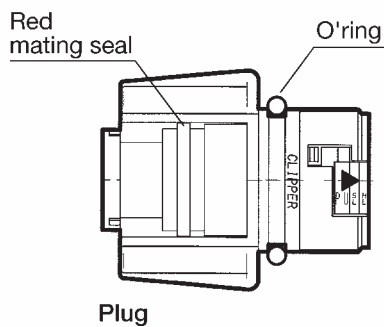
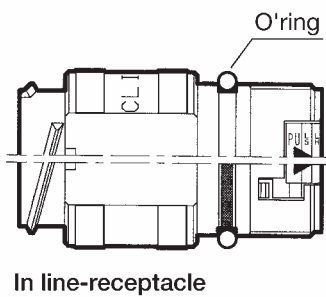
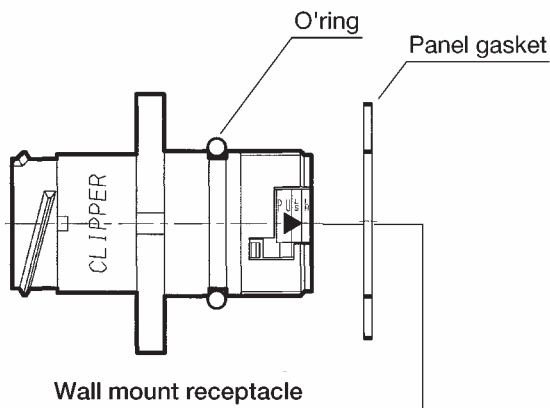

IP68 Configuration (temporary water tightness down to 100 feet)



Clipper Industrial Plastic Connectors

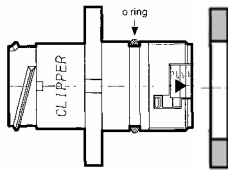
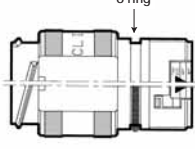
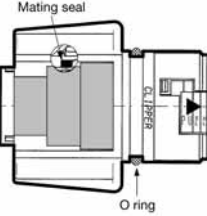
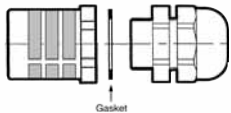

IP68 Configuration

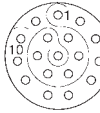
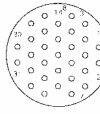
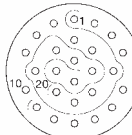
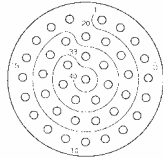
		Shell types (without contacts) and Backshell type	Part numbers			
			Sealed receptacle (with o'ring and panel gasket)	Sealed In-line receptacle	Sealed plug (with o'ring and mating seal)	Anti-decoupling sealing gland backshell
Contacts layouts						
		for male contacts	for male contacts	for female contacts		
Shell sizes	1	4 cts # 16 	CL1M1102	CL1C1101	CL1F1103	CL101021 (pg 13.5)
		9 cts # 20 	CL1M1202	CL1C1201	CL1F1203	
	2	9 cts # 16 	CL1M2102	CL1C2101	CL1F2103	CL102021 (pg 16)
		14 cts # 20 	CL1M2202	CL1C2201	CL1F2203	
	3	18 cts # 16 	CL1M3102	CL1C3101	CL1F3103	CL103021 (pg 21)
		31 cts # 20 	CL1M3202	CL1C3201	CL1F3203	
	4	26 cts # 16 	CL1M4102	CL1C4101	CL1F4103	CL124021 (pg 29) CL104021 (pg 36)
		40 cts # 16 	CL1M4202	CL1C4201	CL1F4203	

Clipper Industrial Plastic Connectors



IP67 Configuration



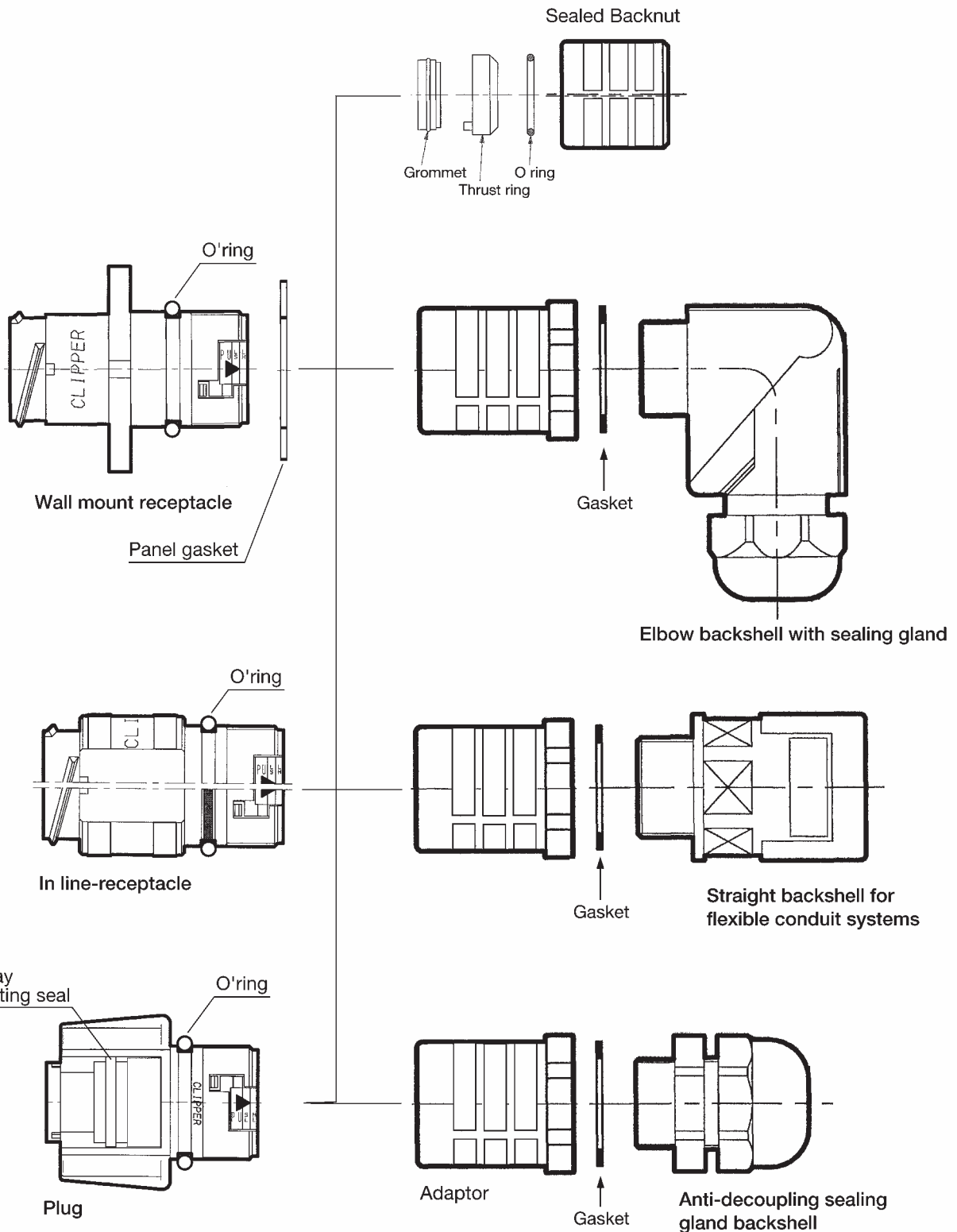





IP67 Configuration (temporary water tightness)



Clipper Industrial Plastic Connectors



IP67 Configuration

		Shell types without contacts	Part numbers				
			Sealed receptacle (with o'ring and panel gasket)		Sealed plug (with o'ring and mating seal)		Sealed In-line receptacle
			for male contacts	for female contacts	for male contacts	for female contacts	for male contacts
Shell sizes	1	4 cts # 16 	CL1M1102	CL1R1102	CL1P1101	CL1F1101	CL1C1101
		9 cts # 20 	CL1M1202			CL1F1201	CL1C1201
	2	9 cts # 16 	CL1M2102	CL1R2102	CL1P2101	CL1F2101	CL1C2101
		14 cts # 20 	CL1M2202			CL1F2201	CL1C2201
	3	18 cts # 16 	CL1M3102	CL1R3102	CL1P3101	CL1F3101	CL1C3101
		31 cts # 20 	CL1M3202			CL1F3201	CL1C3201
	4	26 cts # 16 	CL1M4102			CL1F4101	CL1C4101
		40 cts # 16 	CL1M4202	CL1R4202	CL1P4201	CL1F4201	CL1C4201

Clipper Industrial Plastic Connectors



IP67 Configuration

		Backshell types		Part numbers					
				Sealed backnut		Elbow backshell with sealing gland	Straight backshell for flexible conduit systems		Anti-decoupling sealing gland backshell
				for male contacts	for female contacts				
Shell sizes	1	4 cts # 16							
		9 cts # 20							
	2	9 cts # 16							
		14 cts # 20							
	3	18 cts # 16							
		31 cts # 20							
	4	26 cts # 16							
		40 cts # 16							

Clipper Industrial Plastic Connectors



Mated and unmated connectors with backshells

Overall dimensions in inches

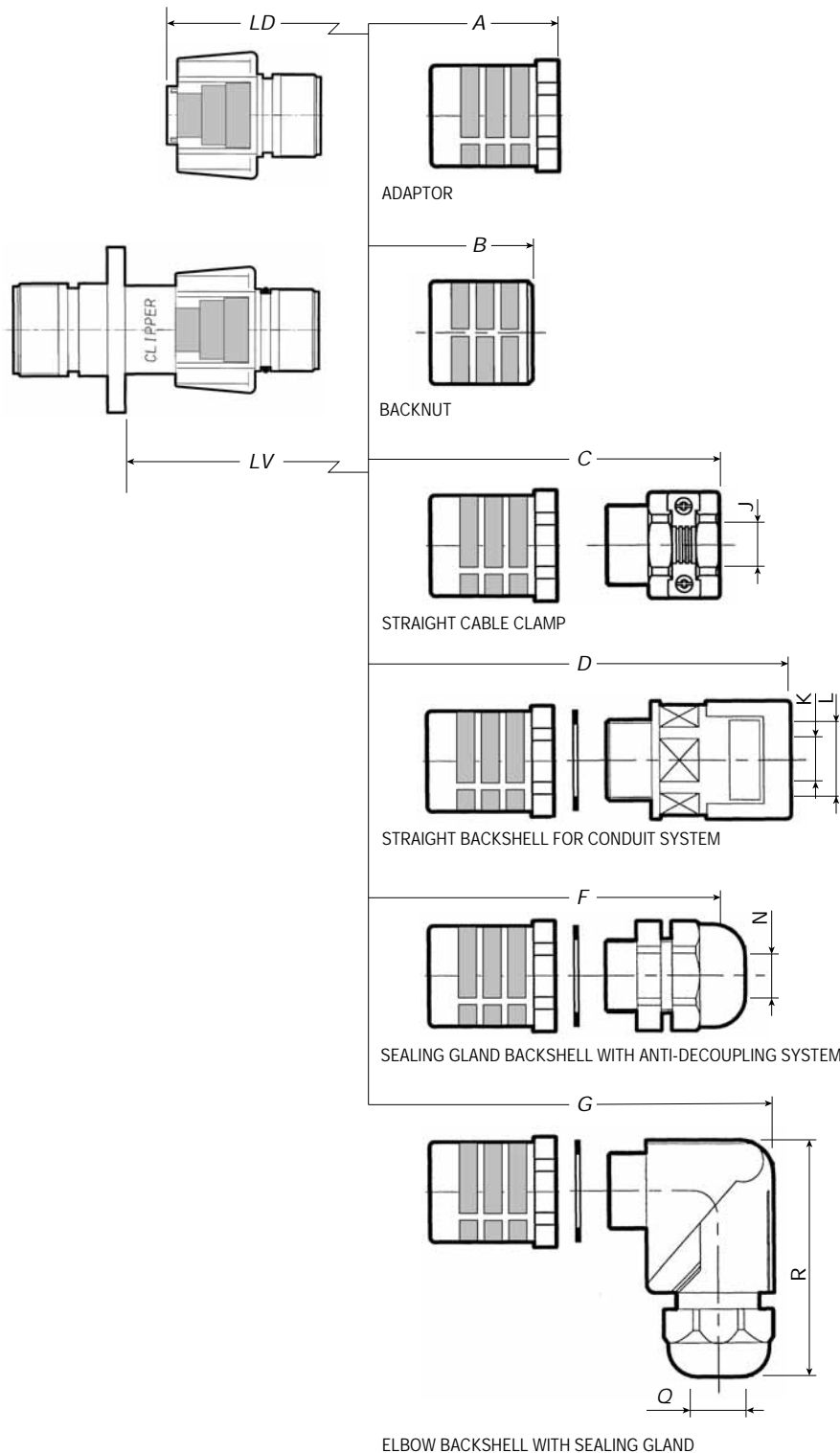

Dimensions					
Dim. (inches)	Shell	1	2	3	4
					(PG 29)(PG 36)
LDA		2.01	2.09	2.09	2.17
LVA		2.29	2.33	2.33	2.41
LDB		1.81	1.85	1.85	-
LVB		2.09	2.09	2.09	-
LDC		2.68	2.85	3.03	3.41
LVC		2.97	3.09	3.27	3.60
LDD		3.41	3.50	3.62	3.70
LVD		3.70	3.74	3.86	3.94
LDF		3.15	3.27	3.35	3.74
LVF		3.43	3.50	3.58	3.98
LDG		3.31	3.46	3.77	4.29
LVG		3.58	3.70	4.01	4.52
R Max.		2.24	2.34	2.87	3.58

Cable acceptance*					
Dim. (inches)	Shell	1	2	3	4
					(PG 29) (PG 36)
J		.24/.55	.24/.63	.31/.83	.39/1.10
Conduit L Pmaflex		.67	.67	.91	1.14
K Max		.63	.63	.85	1.08
N		.24/.47	.39/.55	.51/.71	.71/.98
Q		.24/.47	.39/.55	.51/.71	.71/.98

* For other needs, consult FCI.

Clipper Industrial Plastic Connectors



Dimensions in inches

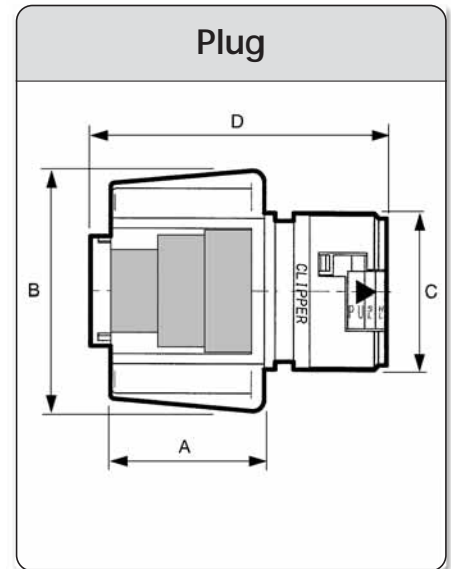
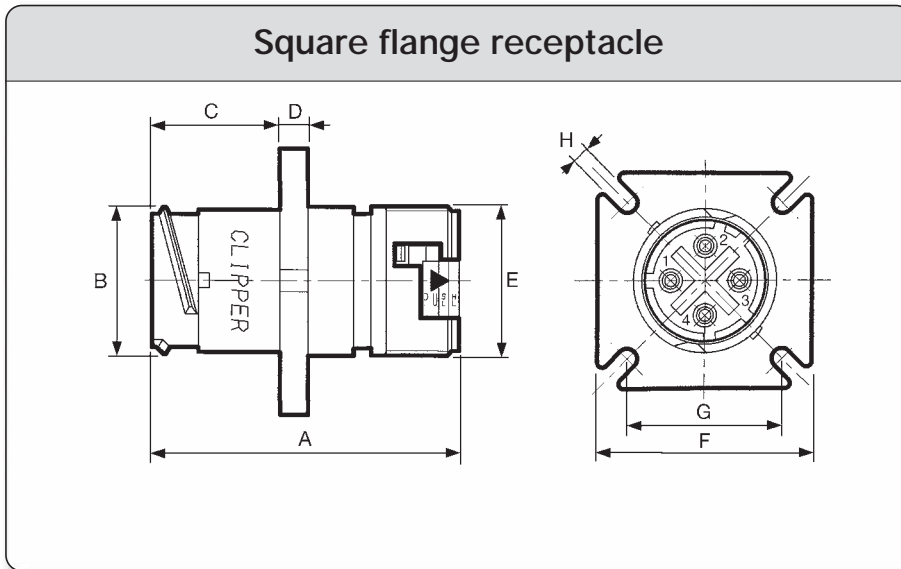

Shell sizes	1	2	3	4
Dim. (inches)				
A	1.67	1.67	1.67	1.67
B	.83	.96	1.14	1.59
C	.71	.71	.71	.71
D	.16	.16	.16	.16
E	.81	.94	1.12	1.57
F	1.17	1.23	1.42	1.89
G min.	.83	.96	1.11	1.43
G Max.	.92	.98	1.17	1.57
H	.13	.13	.15	.15

Shell sizes	1	2	3	4
Dim. (inches)				
A	.8	.8	.8	.8
B	1.15	1.28	1.46	1.92
C	.81	.94	1.12	1.57
D	1.52	1.56	1.56	1.56

Clipper Industrial Plastic Connectors



Manual Crimping Tool

Stamped and Formed Contacts (#16 and #20)

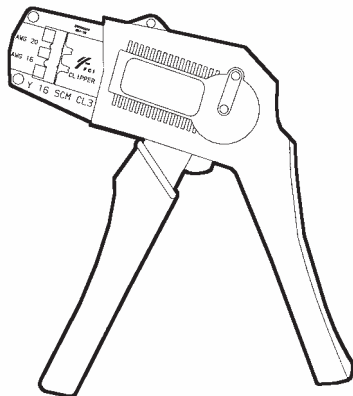

Y16SCMCL3

- Squeeze the plier handles until a final click sounds, release, the pliers should open by themselves.
- Fully insert the contact into the locator (corresponding gauge), the contact crimping lugs should be directed upwards, according to the drawing.
- Put the stripped wire in the crimping part until it comes in contact with the stopper plate. Make sure that no strands stick out of the crimping part.
- Squeeze the plier handles until a final click sounds, release, the pliers should open by themselves.
- Check the overall aspect of the crimping.

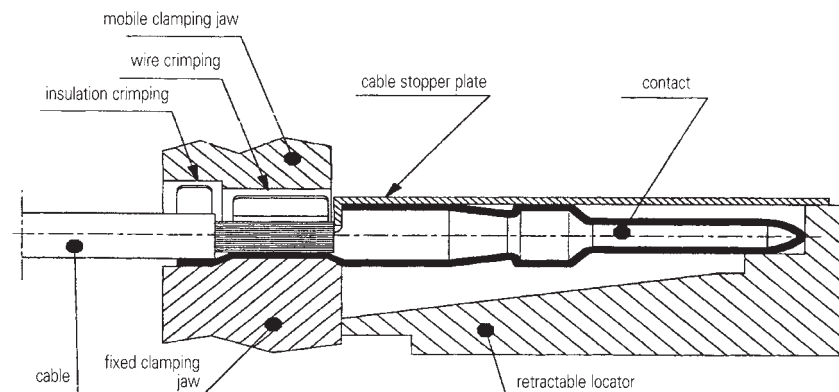

Machined Crimping Contacts (#16 and #20)

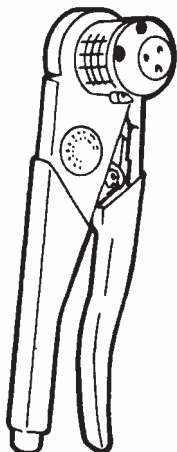

8365
with
locator
8365-02

- Push the cable into the contact barrel and make sure the cable strands stick out of the inspection hole.
- The pliers must be used on the jaws side.
- Squeeze the plier handles until a final click sounds, release, the pliers should open by themselves.
- Insert both wire and contact (or wire, reducing sleeve and contact) between the 4 jaws until stopped by the locator.
- Fully squeeze until a final click sounds, the pliers should open once the crimping is performed
- Extract the wire and crimped contact, then check the overall aspect of the crimping.

Clipper Industrial Plastic Connectors



Automatic crimping tool



UTM2 Automatic crimping tool for Clipper

Description

Electromechanical high speed semi automatic press is designed for mass production and is realized totally in assembled steel parts.

Voltage: 115VAC - 60 Hz
 Power.: 700 Watts
 Weight: 300 lbs. (including one crimp mechanism)
 Dimensions: 939.8x533.4x711.2 mm (37.0"x21.0"x28.0")

Crimping Mechanism (left side miniapplicators)

Contacts	AWG	Contact P/N	Crimp Mech. P/N
16	16-18	CF16 PS 18RF CF16 SC 18RF	CM30-R
20	20-22	CF10 PS 18RF CF10 SC 18RF	CM31-R



Press and crimping mechanism are rental.
 Please contact Customer Service.

Clipper Industrial Plastic Connectors



Panel mounting / Panel cut-out

Panel mounting

There are two types of mounting possible: through the front or through the back of the panel.

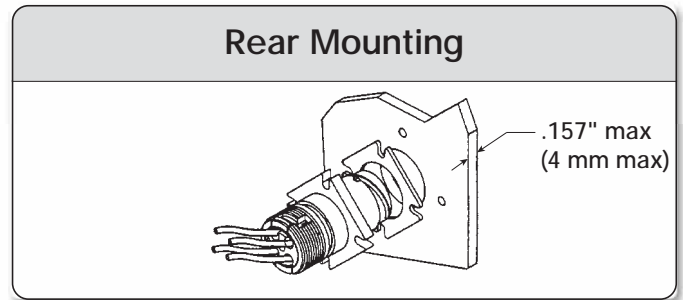
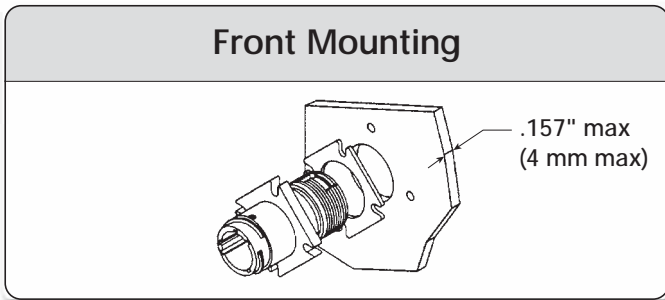

Panel cut-out

• For a sealed mounting, the seal gasket shall be used, making sure the surface is in good condition.

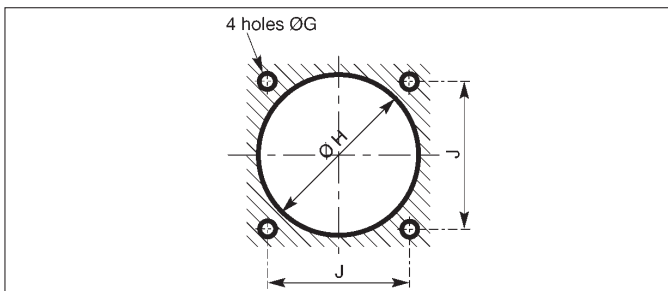

• Observe the drilling hole diameters indicated below.

- Use the recommended screws :
M3 (all shells)
or # 4.40 (shells 1 and 2)
6.32 (shells 3 and 4)

• Respect the coupling torques indicated M3
(all shells) : 0.70 N.m Max

Shell sizes	1	2	3	4
Dim. (inches)				
H	.85	.98	1.22	1.61
I	.84	.97	1.13	1.44
J	.13	.13	.15	.15

Clipper Industrial Plastic Connectors



Wiring Instruction

Stripping Instructions

Use the upmost care with stripping operation :

- Use stripping pliers appropriate for the cable gauge and which are in perfect condition.
- In order to obtain a correct crimping and to maintain all of the connector sealing characteristics, the wires must have the dimensions described below.

Jacketed Cable Stripping Length

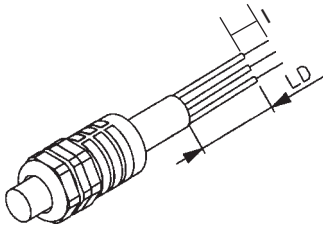

Make a 90° cut at the cable end.

carefully make an incision in order to remove the cable protection on a length LD as described.

Shell size	1	2	3	4	
layouts	Indifferent			26	40
LD mm	60	65	65	80	100
(inch)	(2.36')	(2.56')	(2.56')	(3.15")	(3.94")

Caution : This operation should be realized without deterioration of wires insulation.

Then, follow the normal stripping instructions :

- single wire with machined crimping contacts,
- single wire with stamped and formed crimping contacts

Wire Stripping Length

- With machined crimping contacts

Contact size	I = Wire stripping length
layouts	6 mm (.236")
#20	\varnothing over insulation > 2 mm \Rightarrow I = 5 (> .08" \Rightarrow I = .20") \varnothing over insulation > 2 mm \Rightarrow I = 7 (> .08" \Rightarrow I = .27")

- With stamped and formed crimping contacts

Contact diameter	I = Wire stripping length
#16	4 mm (.157")
#20	4 mm (.157")



Instruction For Assembly

Insertion and extraction of contacts

Single wires

Contact insertion and extraction is performed without a tool thanks to the retainer plate system.

Insertion

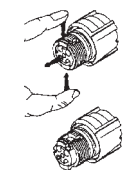

1) With the thumb and index finger, squeeze the retainer plate flaps and pull backwards : the plate is then in the unlocked position.

2) Fully insert the wired contact in the cavity.

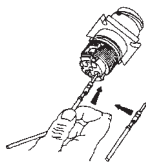

3) Repeat the same procedure for the other contacts.

4) Once again squeeze the retainer plate flaps and push forwards: the plate is then locked and retains the contacts (90 N of retention force for contacts of 1.6 mm dia.)

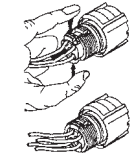

5) The plate can only be pushed back if the contacts are correctly engaged (backup security)

Extraction

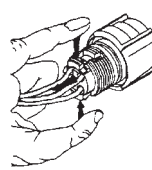

1) With the thumb and index finger, squeeze the retainer plate flaps and pull backwards : the plate is then in the unlocked position.

2) Pull the contact wire: the contact comes out of the cavity.

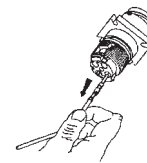

3) Repeat the same procedure for the other contacts.

Special case of jacketed cables

- 1) Locate the first contact and the corresponding cavity.
- 2) The wire should be described as a buckle as described below.
- 3) Unlock the retainer plate as described above.
- 4) Fully insert the wired contact in the cavity.
- 5) Respect the same procedure for the other contacts
- 6) Once again squeeze the retainer plate flaps and push forwards : the plate is then locked

Special case of jacketed cables

- 7) Manually fully screw the adaptor and the backshell on the connector.

Caution : In the sealed version don't forget the O-ring.

- 8) Push forwards the cable of 10 mm in the backshell.
- 9) Fully screw on the backshell with a wrench while keeping the adaptor with another wrench.

Note : The plate can only be pushed back if the contacts are correctly engaged (backup- security)

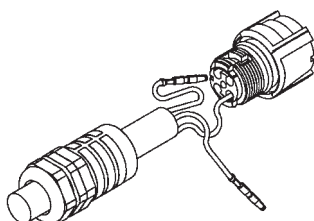

Clipper Industrial Plastic Connectors



Instruction For Assembly

Adaptor and PG electrical thread backshells

The CLIPPER connector must be equipped with an adaptor in order to use a PG electrical thread backshell (e.g.: cable clamp or sealing gland, or flexible conduits system backshells, etc.)

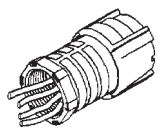

- 1) Manually, fully screw the adaptor on the connector, the hexagonal nut towards the rear.
- 2) In the sealed version, cover the O-ring.
- 3) Manually, fully screw the PG thread backshell of your choice.

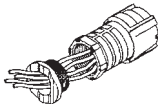

Note: In the case of an elbow backshell, it is possible to adjust the position according to the angle desired.

Heat shrink boot

Shrink sleeve as follows :

- 1) Use heat gun with an air deflector nozzle.
- 2) Adjust air deflector opening to accommodate tubing size. Turn switch ON. Wait until full heat output is reached.
- 3) Position the air deflector over section of tubing to be shrunk. Start at pre-shrunk section and work towards open end.
- 4) When tubing begins to shrink, move gun so that air is distributed in a band around the tubing circumference causing it to shrink evenly around the cable.
- 5) Move nozzle to adjacent section and shrink in the same manner. Repeat process on section at a time until entire length is shrunk.

Avoid excessive heat. Direct heat away from connector assembly to prevent damage.

**Instruction
for polarizing connector mounting**



CP16SW9700

When the insert is partially filled with contacts, place polarization contact into selected hole location in the FEMALE INSERT and push in until seated.

- Polarization contacts are used to provide keying capabilities for the CLIPPER series.
- Polarization contacts are used in the **socket-cavities** of standard plugs and reverse receptacles.

In order to lock the couple of chosen connectors, you have to let free the cavity in front of the polarization contact.

To avoid the connection with other connectors, you have to insert a contact in the cavity in front of the polarization contact.

Grommet Backshell Assembly

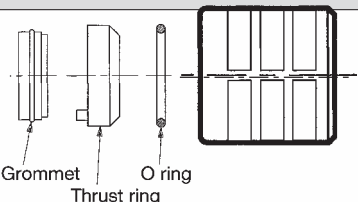

Grommet Thrust ring O ring

- 1) Position the O-ring at the bottom of the backnut.
- 2) Run the backnut around the cable.
- 3) Unlock the retainer plate.
- 4) Position the grommet in the thrust ring, resting against the retainer plate.
- 5) Insert the contacts through the grommet and the retainer plate.
- 6) Lock the retainer plate.
- 7) Screw the backshell.

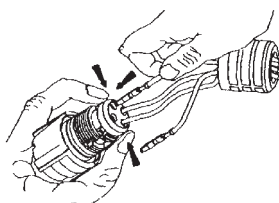

Clipper Industrial Plastic Connectors



General technical information

Degree of protection in accordance with CEI 529, DIN 40050, NF EN 60529

First index Protection against accidental or inadvertent contact. Prot. against ingress of foreign bodies.		Second index Protection against ingress of water		Third index Protection against mechanical strength	
Index	Test	0 No protection	2 Protection against diagonal drop water drips (up to <math>< 15^\circ</math> of vertical)	0 No protection	Test
0	#0 No protection	#0 x 0		Troisième chiffre	
1	#1 Ball $\varnothing 2$ inch Protection against contact with any large area by hand, protect. against large solid foreign bodies with $\varnothing > 2$ inch.	1 Protection against vertical drop water drips. #1 x 1	 #2 x 2 $\pm 15^\circ$	1	Impact strength : 0,225 J #1 x 1 250 g 5,9 inch
2	#2 Ball $\varnothing .5$ inch Test finger Protection against contact with the fingers, prot. against solid foreign bodies with $\varnothing 0.5$ inch	3 Protection against diagonal drop water drips (up to <math>< 60^\circ</math> out of vertical) #3 x 3	4 Protection against splash water from all directions #4 x 4	3	Impact strength : 0,5 J #3 x 3 250 g 7,8 inch
3	#3 Steel wire $\varnothing 0.1$ inch Protection against tools wires or similar objects with $\varnothing > 0.1$ inch, prot. against small foreign solid bodies with $\varnothing > 0.1$ inch	5 Protection against water (out of a nozzle) from all directions #5 x 5		5	Impact strength : 2 J #5 x 5 500 g 15,7 inch
4	#4 Steel wire $\varnothing .04$ inch Protection against tools wires or similar objects with $\varnothing > .04$ inch, prot. against small foreign solid bodies with $\varnothing > .04$ inch	6 Proof against temporary flooding #6 x 6		7	Impact strength : 6 J #7 x 7 1,5 kg 15,7 inch
5	#5 Full protection against acid, or inadiv. contact. Prot. against interior injurious dust deposits. Talc	7 Protection against water plunging Proof against temporary water plunging #7 x 7	8 Water tight W Proof against water pressure	9	Impact strength : 20 J #9 x 9 5 kg 15,7 inch
6	#6 Total protection against acid, or inadiv. contact. Protection against of dust.				

EXAMPLE : IP66-5 means: - Total protection against dust
- Proof against temporary flooding
- Proof against impact strength of 2 Joule

Clipper Industrial Plastic Connectors



Conversion Table

(mm)	(inches)
0.1	0.00394
0.2	0.00788
0.3	0.01182
0.4	0.01576
0.5	0.01970
0.6	0.02364
0.7	0.02758
0.8	0.03152
0.9	0.03546
1.0	0.03940
1.1	0.04334
1.2	0.04728
1.3	0.05122
1.4	0.05516
1.5	0.05910
1.6	0.06304
1.7	0.06698
1.8	0.07092
1.9	0.07486
2.0	0.07880
2.1	0.08274
2.2	0.08668
2.3	0.09062
2.4	0.09456
2.5	0.09850
2.6	0.10244
2.7	0.10638
2.8	0.11032
2.9	0.11426
3.0	0.11820
3.1	0.12214
3.2	0.12608
3.3	0.13002
3.4	0.13396
3.5	0.13790
3.6	0.14184
3.7	0.14578
3.8	0.14972
3.9	0.15366
4.0	0.15760
4.1	0.16154
4.2	0.16548
4.3	0.16942
4.4	0.17336
4.5	0.17730
4.6	0.18124
4.7	0.18518
4.8	0.18912
4.9	0.19306
5.0	0.19700
5.2	0.20488
5.4	0.21276
5.6	0.22064
5.8	0.22852
6.0	0.23640
6.2	0.24428
6.4	0.25216
6.6	0.26004
6.8	0.26792
7.0	0.27580
7.2	0.28368
7.4	0.29156
7.6	0.29944
7.8	0.30732
8.0	0.31520

(mm)	(inches)
8.2	0.32308
8.4	0.33096
8.6	0.33884
8.8	0.34672
9.0	0.35460
9.2	0.36248
9.4	0.37036
9.6	0.37824
9.8	0.38612
10.0	0.39400
10.5	0.41370
11.0	0.43340
11.5	0.45310
12.0	0.47280
12.5	0.49250
13.0	0.51220
13.5	0.53190
14.0	0.55160
14.5	0.57130
15.0	0.59100
15.5	0.61070
16.0	0.63040
16.5	0.65010
17.0	0.66980
17.5	0.68950
18.0	0.70920
18.5	0.72890
19.0	0.74860
19.5	0.76830
20.0	0.78800
20.5	0.80770
21.0	0.82740
21.5	0.84710
22.0	0.86680
22.5	0.88650
23.0	0.90620
23.5	0.92590
24.0	0.94560
24.5	0.96530
25.0	0.98500
25.5	1.00470
26.0	1.02440
26.5	1.04410
27.0	1.06380
27.5	1.08350
28.0	1.10320
28.5	1.12290
29.0	1.14260
29.5	1.16230
30.0	1.18200
30.5	1.20170
31.0	1.22140
31.5	1.24110
32.0	1.26080
32.5	1.28050
33.0	1.30020
33.5	1.31990
34.0	1.33960
34.5	1.35930
35.0	1.37900
35.5	1.39870
36.0	1.41840
36.5	1.43810
37.0	1.45780
37.5	1.47750

(mm)	(inches)
38.0	1.49720
38.5	1.51690
39.0	1.53660
39.5	1.55630
40.0	1.57600
40.5	1.59570
41.0	1.61540
41.5	1.63510
42.0	1.65480
42.5	1.67450
43.0	1.69420
43.5	1.71390
44.0	1.73360
44.5	1.75330
45.0	1.77300
45.5	1.79270
46.0	1.81240
46.5	1.83210
47.0	1.85180
47.5	1.87150
48.0	1.89120
48.5	1.91090
49.0	1.93060
49.5	1.95030
50.0	1.97000
51.0	2.00940
52.0	2.04880
53.0	2.08820
54.0	2.12760
55.0	2.16700
56.0	2.20640
57.0	2.24580
58.0	2.28520
59.0	2.32460
60.0	2.36400
61.0	2.40340
62.0	2.44280
63.0	2.48220
64.0	2.52160
65.0	2.56100
66.0	2.60040
67.0	2.63980
68.0	2.67920
69.0	2.71860
70.0	2.75800
71.0	2.79740
72.0	2.83680
73.0	2.87620
74.0	2.91560
75.0	2.95500
80.0	3.15200
85.0	3.34900
90.0	3.54600
100.0	3.94000
200.0	7.88000
400.0	15.76000
600.0	23.64000
800.0	31.52000
1000.0	39.40000
1200.0	47.28000
1600.0	63.04000
2000.0	78.80000
3200.0	126.08000

(°C)	(°F)
- 70	- 94
- 65	- 85
- 55	- 67
- 50	- 58
- 40	- 40
0	32
37	98.6
80	176
125	257
150	302
170	338
200	392
250	482

bar	psi	mmHg (torr)
10	145.0	7600
5	72.5	3800
2	29.0	1520
1	14.5	760
0.5	7.2	380
0.1	1.4	76

mbar	psi	torr (mmHg)
10	145.0	7600
5	72.5	3800
2	29.0	1520
1	14.5	760
0.5	7.2	380
0.1	1.4	76

- (1) 6145DJ - Câbles multipaires (armés, paires blindées) 250 MZH.
 (2) 6145DJ - Câbles multipaires (armés, paires non blindées) 250 MZH.

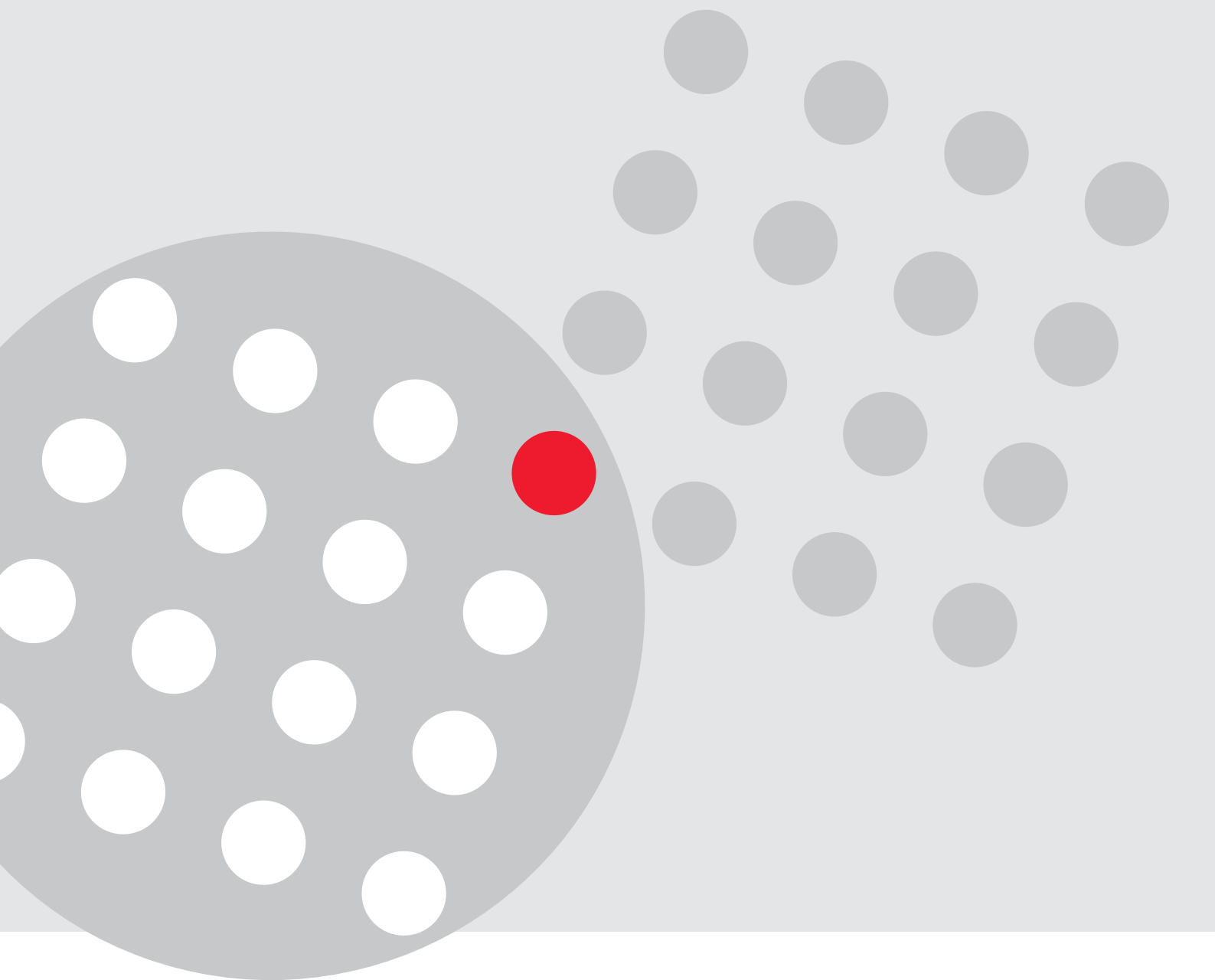

www.souriau.com

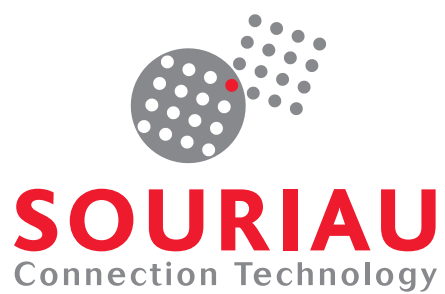



Стандарт Электрон Связь

Мы молодая и активно развивающаяся компания в области поставок электронных компонентов. Мы поставляем электронные компоненты отечественного и импортного производства напрямую от производителей и с крупнейших складов мира.

Благодаря сотрудничеству с мировыми поставщиками мы осуществляем комплексные и плановые поставки широчайшего спектра электронных компонентов.

Собственная эффективная логистика и склад в обеспечивает надежную поставку продукции в точно указанные сроки по всей России.

Мы осуществляем техническую поддержку нашим клиентам и предпродажную проверку качества продукции. На все поставляемые продукты мы предоставляем гарантию .

Осуществляем поставки продукции под контролем ВП МО РФ на предприятия военно-промышленного комплекса России , а также работаем в рамках 275 ФЗ с открытием отдельных счетов в уполномоченном банке. Система менеджмента качества компании соответствует требованиям ГОСТ ISO 9001.

Минимальные сроки поставки, гибкие цены, неограниченный ассортимент и индивидуальный подход к клиентам являются основой для выстраивания долгосрочного и эффективного сотрудничества с предприятиями радиоэлектронной промышленности, предприятиями ВПК и научно-исследовательскими институтами России.

С нами вы становитесь еще успешнее!

Наши контакты:

Телефон: +7 812 627 14 35

Электронная почта: sales@st-electron.ru

Адрес: 198099, Санкт-Петербург,
Промышленная ул, дом № 19, литера Н,
помещение 100-Н Офис 331