

SINGLE SUPPLY HI-SLEW RATE DUAL OPERATIONAL AMPLIFIER

■ GENERAL DESCRIPTION

The NJM2717 is a high slew rate single supply dual operational amplifier. It offers excellent features of a 40V/us (typ.) high slew rate in a single supply and low operating voltage from 2.7V, which provide a benefit to buffer, filter and ground level signal detection circuit design. Therefore The NJM2717 is suitable for CCD buffer and AD/DA converter buffer using in facsimile/scanner, current detector in inverter controller, PWM motor controller and Tuner/Communication devices.

The NJM2717 is available in a wide variety packages 8-lead DIP, and 8-lead surface-mount packages of SOP (DMP), SSOP and MSOP (TVSP).

■ PACKAGE OUTLINE

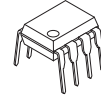

**NJM2717D
(DIP8)**

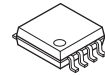

**NJM2717M
(DMP8)**

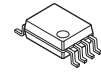

**NJM2717V
(SSOP8)**



**NJM2717RB1
(MSOP8 (TVSP8))**

■ FEATURES

- Single Supply
- Operating Voltage 2.7V to 12V
- High Slew Rate 40V/μs Typ. (at V⁺=5V)
- Operating Current 8mA typ. (at V⁺=5V)
- Output Voltage Range V_{OH} ≥ 4.5V Typ. (at V⁺=5V, R_L=4kΩ)
V_{OL} ≤ 0.05V Typ. (at V⁺=5V, R_L=4kΩ)
- Bipolar Technology
- Package Outline DIP8,
DMP8,
SSOP8,
MSOP8 (TVSP8) MEET JEDEC MO-187-DA/THIN TYPE

■ PIN CONFIGURATION

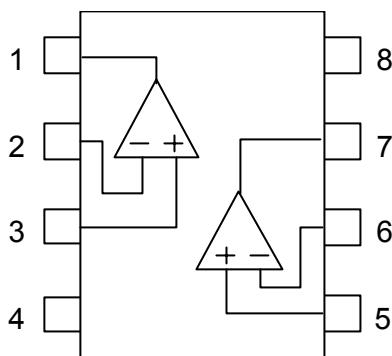

PIN FUNCTION

1. A OUTPUT
2. A -INPUT
3. A +INPUT
4. GND
5. B +INPUT
6. B -INPUT
7. B OUTPUT
8. V⁺

**NJM2717D
NJM2717M
NJM2717V
NJM2717RB1
(Top View)**

NJM2717

■ ABSOLUTE MAXIMUM RATINGS

(Ta=25°C)

PARAMETER	SYMBOL	RATINGS	UNIT
Supply Voltage	V ⁺	15.0	V
Differential Input Voltage	V _{ID}	± 3	V
Input Common Mode Voltage Range	V _{ICM}	-0.3 to +15.0(Note 1)	V
Power Dissipation	P _D	(DIP8) 500 (DMP8) 300 (SSOP8) 250 (MSOP8 (TVSP8)) 320	mW
Output Sink Current	I _{SINK}	10	mA
Operating Temperature Range	T _{opr}	-40 to +85	°C
Storage Temperature Range	T _{stg}	-40 to +125	°C

(Note 1) For supply voltage less than 15V, the absolute maximum input voltage is equal to the supply voltage.

■ RECOMMENDED OPERATING CONDITION

(Ta=25°C)

PARAMETER	SYMBOL	RATING	UNIT
Supply Voltage	V ⁺	2.7 to 12.0	V

■ ELECTRICAL CHARACTERISTICS

●DC CHARACTERISTICS

(V⁺=5V, Ta=25°C)

PARAMETER	SYMBOL	TEST CONDITION	MIN	TYP	MAX	UNIT
Operating Current	I _{CC}	R _L =∞, no signal	-	8.0	11.0	mA
Input Offset Voltage	V _{IO}	R _S =0Ω	-	1	11	mV
Input Bias Current	I _B		-	2	4.4	μA
Input Offset Current	I _{IO}		-	0.2	0.5	μA
Voltage Gain	A _V	R _L ≥ 10kΩ, V _O =1.5V to 3.5V	60	75	-	dB
Common Mode Rejection Ratio	CMR	0V ≤ V _{CM} ≤ 3.8V	45	80	-	dB
Supply Voltage Rejection Ratio	SVR	V ⁺ =4V to 8V	50	85	-	dB
Output Voltage 1	V _{OH1}	R _L =4kΩ to GND	4.3	4.5	-	V
	V _{OL1}		-	0.05	0.1	V
Output Voltage 2	V _{OH2}	R _L =4kΩ to 2.5V	4.5	4.7	-	V
	V _{OL2}		-	0.1	0.5	V
Output Source Current	I _{SOURCE}		1	2.5	-	mA
Output Sink Current	I _{SINK}		2.5	6	-	mA
Input Common Mode Voltage Range	V _{ICM}		0 to 3.8	-	-	V

●AC CHARACTERISTICS

(V⁺=5V, Ta=25°C)

PARAMETER	SYMBOL	TEST CONDITION	MIN	TYP	MAX	UNIT
Unity Gain Bandwidth	f _T		-	20	-	MHz

●TRANSIENT CHARACTERISTICS

(V⁺=5V, Ta=25°C)

PARAMETER	SYMBOL	TEST CONDITION	MIN	TYP	MAX	UNIT
Slew Rate	SR		-	40	-	V/μs

■ ELECTRICAL CHARACTERISTICS

●DC CHARACTERISTICS

($V^+=12V, T_a=25^\circ C$)

PARAMETER	SYMBOL	TEST CONDITION	MIN	TYP	MAX	UNIT
Operating Current	I_{CC}	$R_L = \infty$, no signal	-	10.0	14.5	mA
Input Offset Voltage	V_{IO}	$R_S = 0\Omega$	-	1	12	mV
Input Bias Current	I_B		-	2.1	4.4	μA
Input Offset Current	I_{IO}		-	0.2	1	μA
Voltage Gain	A_V	$R_L \geq 10k\Omega, V_O = 2V$ to 10V	60	80	-	dB
Common Mode Rejection Ratio	CMR	$0V \leq V_{CM} \leq 10.8V$	45	80	-	dB
Supply Voltage Rejection Ratio	SVR	$V^+ = 8V$ to 12V	50	85	-	dB
Output Voltage 1	V_{OH1}	$R_L = 10k\Omega$ to GND	11.3	11.5	-	V
	V_{OL1}		-	0.1	0.3	V
Output Voltage 2	V_{OH2}	$R_L = 10k\Omega$ to 6V	11.5	11.7	-	V
	V_{OL2}		-	0.1	0.5	V
Output Source Current	I_{SOURCE}		1	3	-	mA
Output Sink Current	I_{SINK}		2.5	8	-	mA
Input Common Mode Voltage Range	V_{ICM}		0 to 10.8	-	-	V

●AC CHARACTERISTICS

($V^+=12V, T_a=25^\circ C$)

PARAMETER	SYMBOL	TEST CONDITION	MIN	TYP	MAX	UNIT
Unity Gain Bandwidth	f_T		-	21	-	MHz

●TRANSIENT CHARACTERISTICS

($V^+=12V, T_a=25^\circ C$)

PARAMETER	SYMBOL	TEST CONDITION	MIN	TYP	MAX	UNIT
Slew Rate	SR		-	45	-	V/ μs

NJM2717

■ ELECTRICAL CHARACTERISTICS

●DC CHARACTERISTICS

($V^+=2.7V, T_a=25^\circ C$)

PARAMETER	SYMBOL	TEST CONDITION	MIN	TYP	MAX	UNIT
Operating Current	I_{CC}	$R_L=\infty$, no signal	-	6	8.5	mA
Input Offset Voltage	V_{IO}	$R_S=0\Omega$	-	1	10	mV
Input Bias Current	I_B		-	1.7	4.4	μA
Input Offset Current	I_{IO}		-	0.2	0.5	μA
Voltage Gain	A_V	$R_L \geq 10k\Omega, V_O=0.85V$ to 1.85V	60	73	-	dB
Common Mode Rejection Ratio	CMR	$0V \leq V_{CM} \leq 1.5V$	45	80	-	dB
Supply Voltage Rejection Ratio	SVR	$V^+=2.7V$ to 4V	50	75	-	dB
Output Voltage 1	V_{OH1}	$R_L=4k\Omega$ to GND	2.5	2.6	-	V
	V_{OL1}		-	0.05	0.1	V
Output Voltage 2	V_{OH2}	$R_L=4k\Omega$ to 1.35V	2.6	2.65	-	V
	V_{OL2}		-	0.1	0.2	V
Output Source Current	I_{SOURCE}		1	2.5	-	mA
Output Sink Current	I_{SINK}		2.5	5	-	mA
Input Common Mode Voltage Range	V_{ICM}		0 to 1.5	-	-	V

●AC CHARACTERISTICS

($V^+=2.7V, T_a=25^\circ C$)

PARAMETER	SYMBOL	TEST CONDITION	MIN	TYP	MAX	UNIT
Unity Gain Bandwidth	f_T		-	19	-	MHz

●TRANSIENT CHARACTERISTICS

($V^+=2.7V, T_a=25^\circ C$)

PARAMETER	SYMBOL	TEST CONDITION	MIN	TYP	MAX	UNIT
Slew Rate	SR		-	30	-	V/ μs

■ Typical Characteristics

Operating Current vs. Supply Voltage

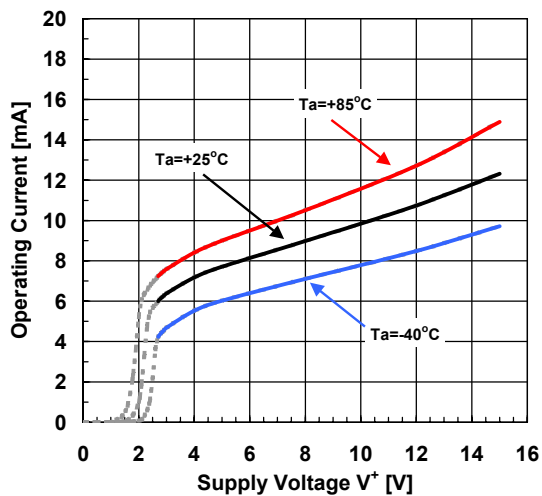

Operating Current vs. Ambient temperature

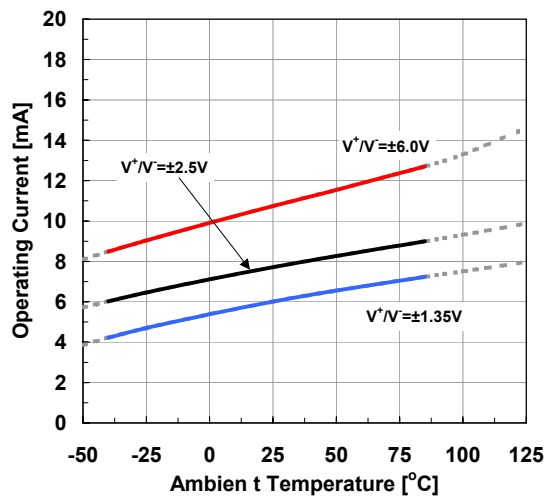

Input Offset Voltage vs. Supply Voltage

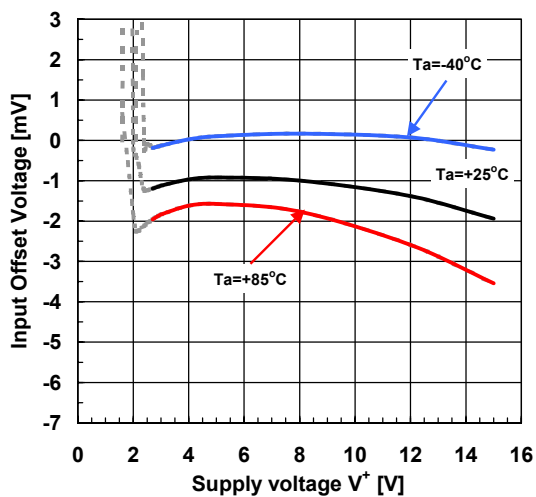

Input Offset Voltage vs. Ambient Temperature

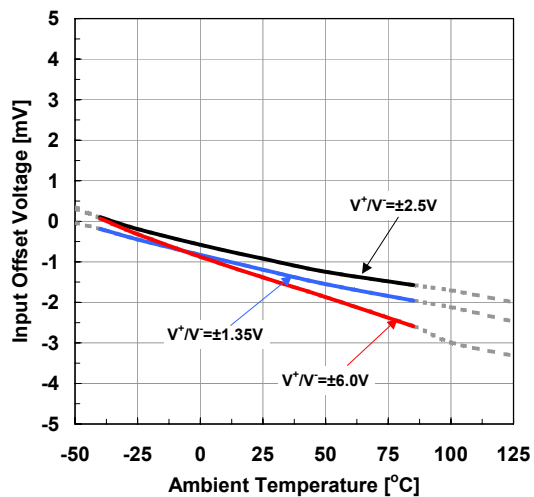

Typical Characteristics

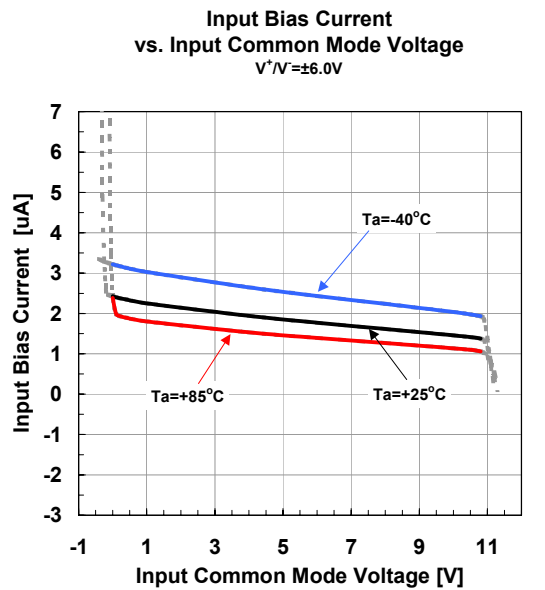
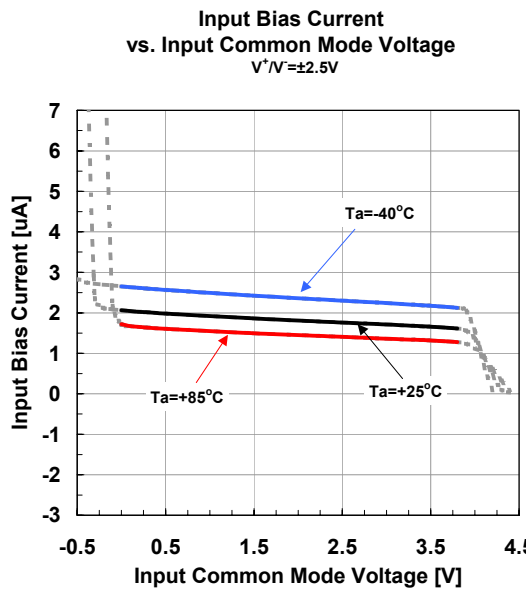
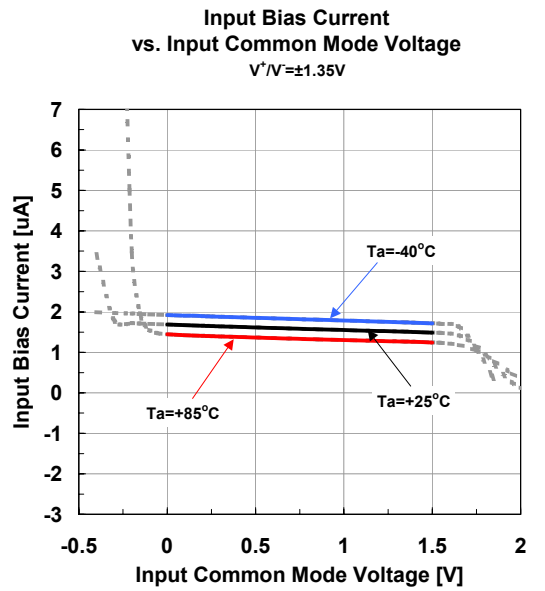
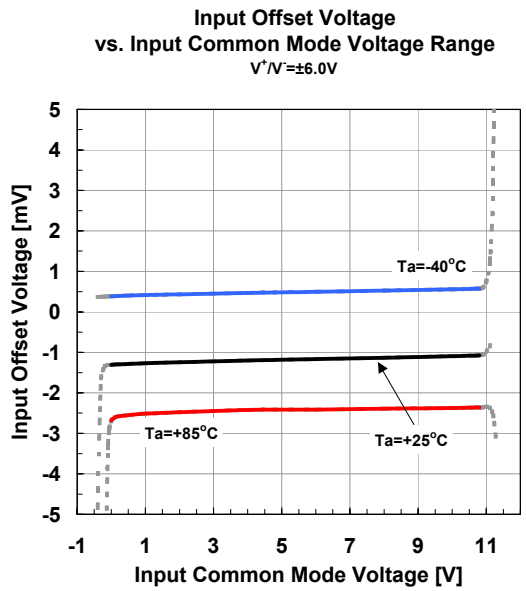
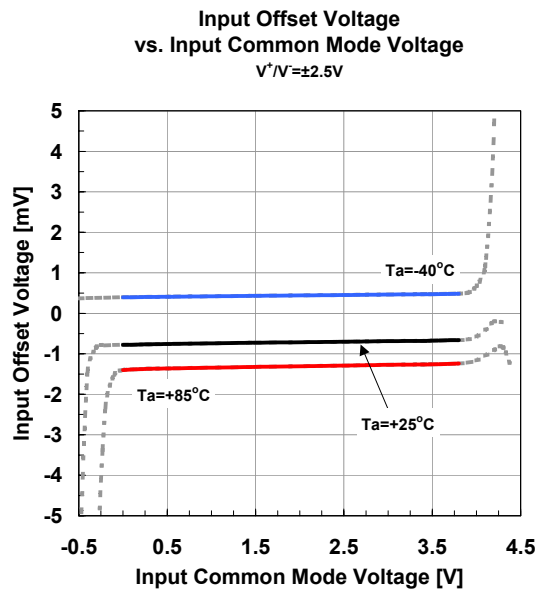
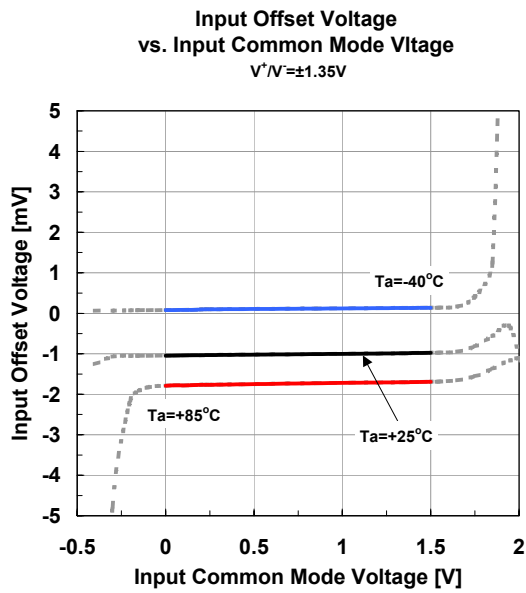

■ Typical Characteristics

Maximum Output Voltage vs. Supply Voltage
 $G_V=OPEN, R_L=4k\Omega$

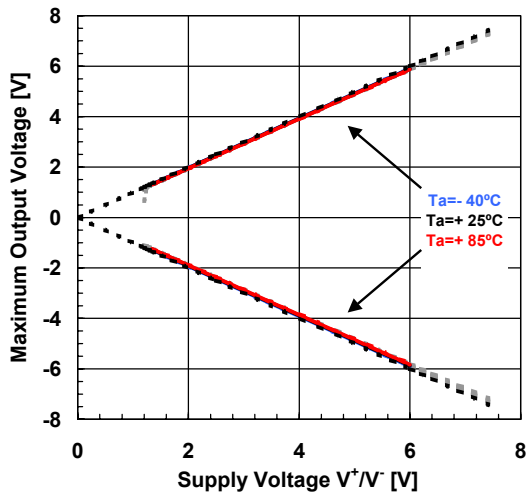

Maximum Output Voltage vs. Ambient Temperature
 $G_V=OPEN, R_L=4k\Omega$

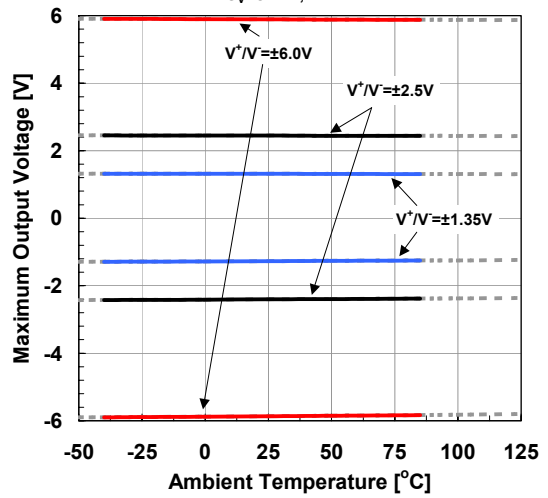

Maximum Output Voltage vs. Load Resistance
 $G_V=OPEN, T_a=+25^\circ C$

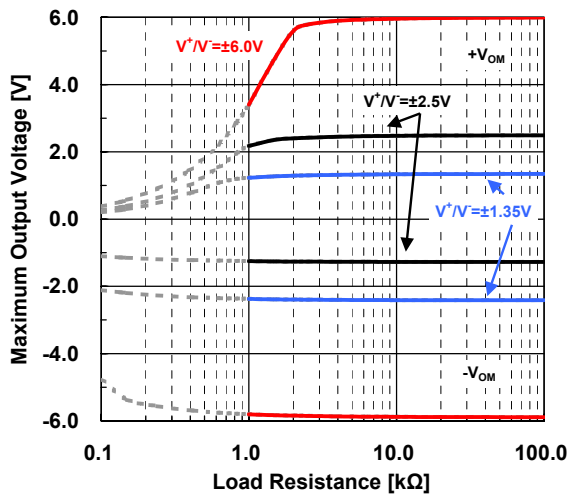

Maximum Output Voltage vs. Load Resistance
 $V^+/V^-=\pm 1.35V, G_V=OPEN$

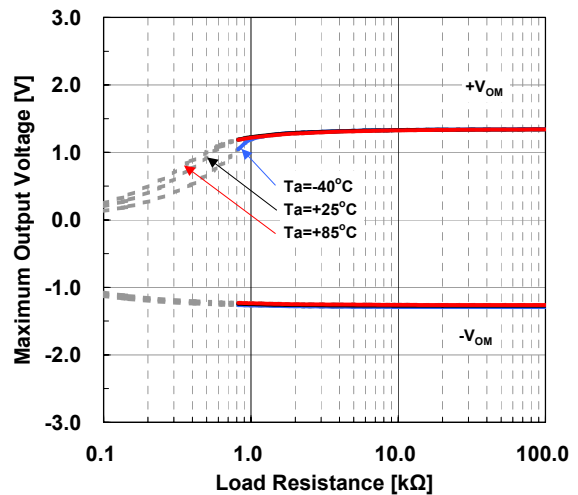

Maximum Output Voltage vs. Load Resistance
 $V^+/V^-=\pm 2.5V, G_V=OPEN$

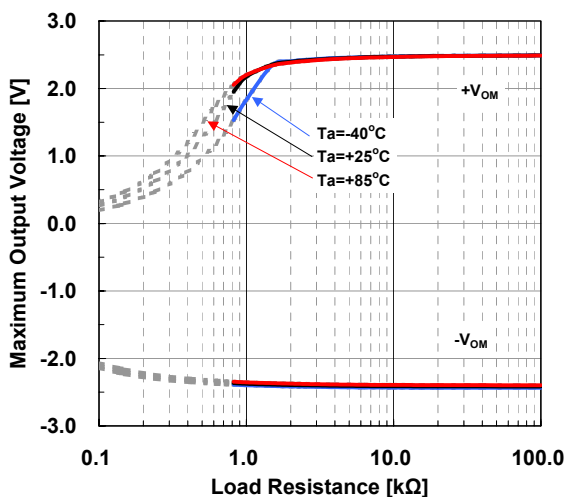

Maximum Output Voltage vs. Load Resistance
 $V^+/V^-=\pm 6.0V, G_V=OPEN$

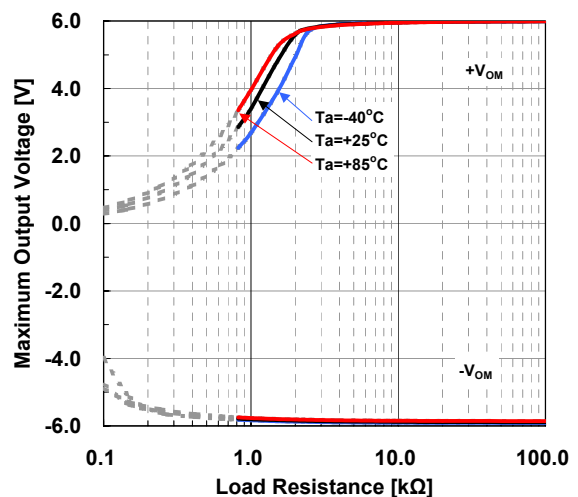

■ Typical Characteristics

Maximum Output Voltage
vs. Load Resistance
 $V^+=+2.7V, V=GND, G_V=OPEN$

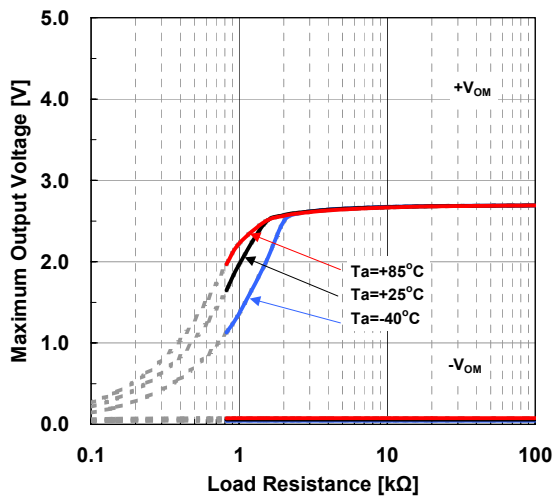

Maximum Output Voltage
vs. Load Resistance
 $V^+=+2.7V, V=GND, G_V=OPEN$

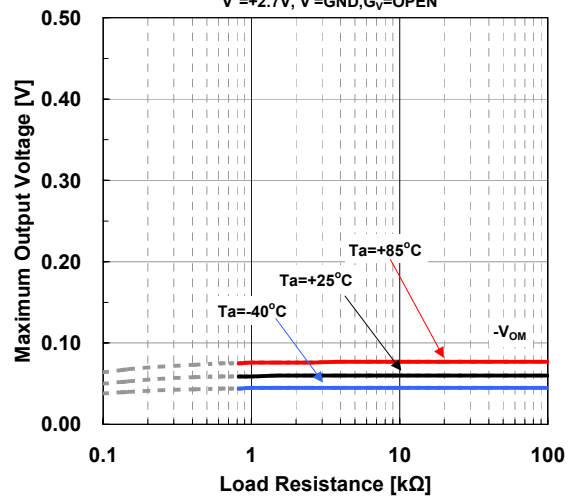

Maximum Output Voltage
vs. Load Resistance
 $V^+=+5.0V, V=GND, G_V=OPEN$

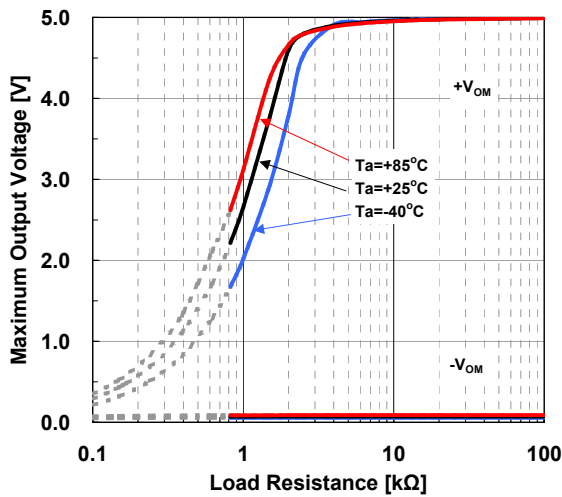

Maximum Output Voltage
vs. Load Resistance
 $V^+=+5.0V, V=GND, G_V=OPEN$

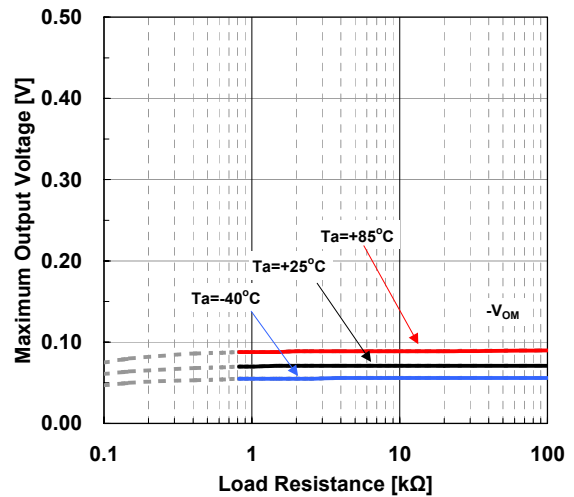

Maximum Output Voltage
vs. Load Resistance
 $V^+=+12.0V, V=GND, G_V=OPEN$

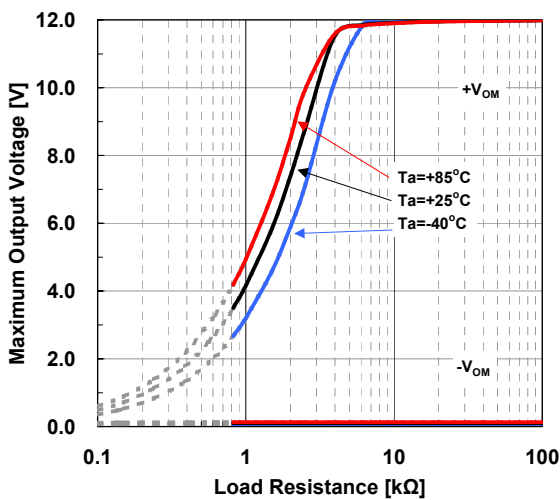

Maximum Output Voltage
vs. Load Resistance
 $V^+=+12.0V, V=GND, G_V=OPEN$

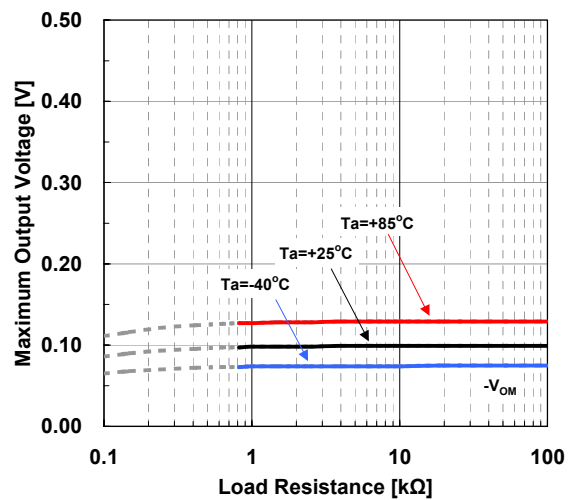

■ Typical Characteristics

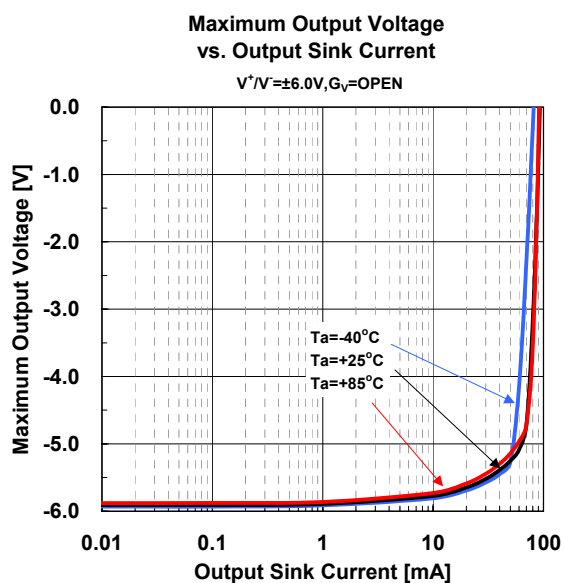
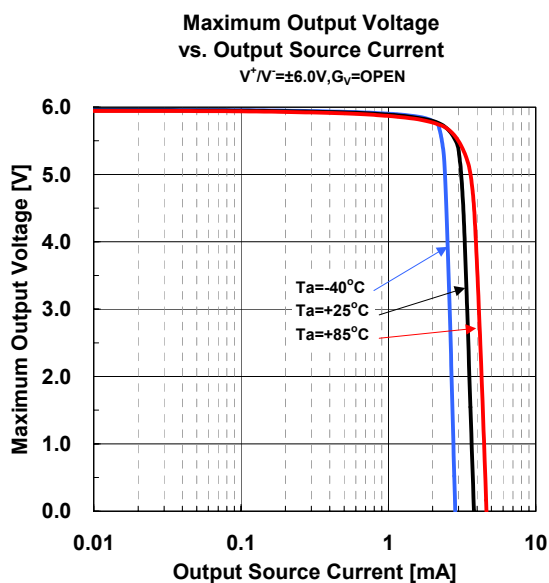
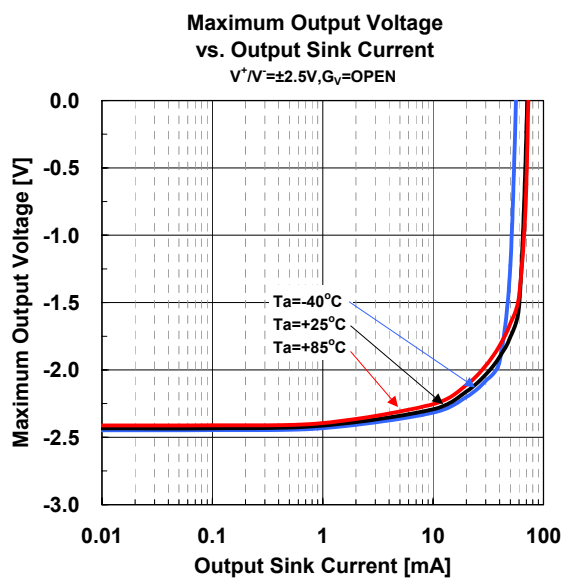
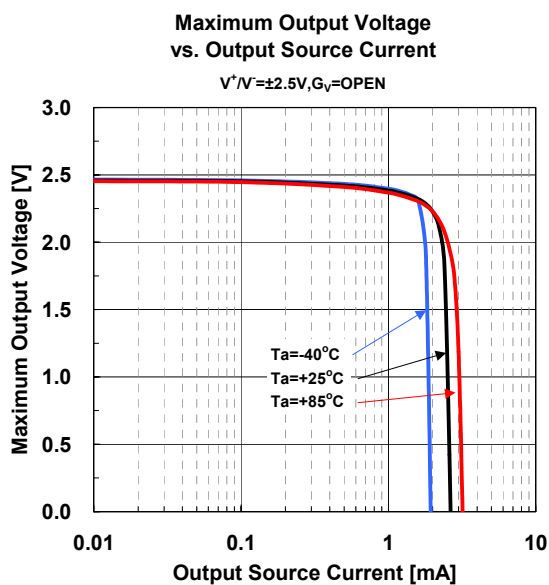
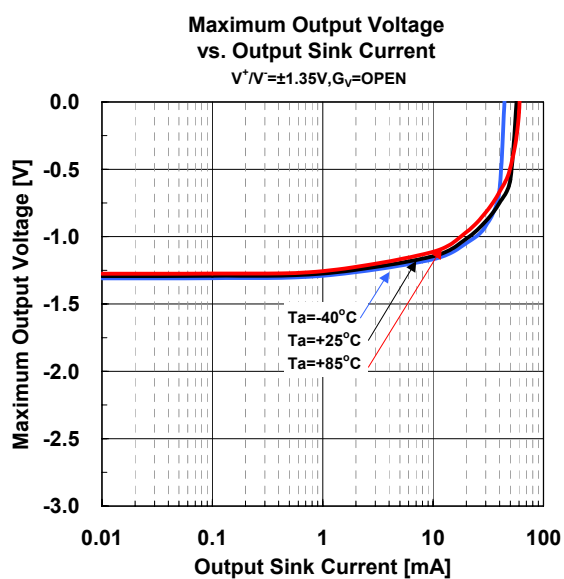
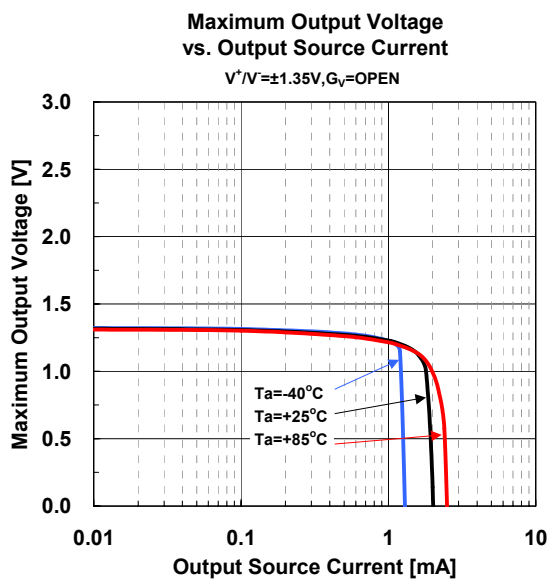

■ Typical Characteristics

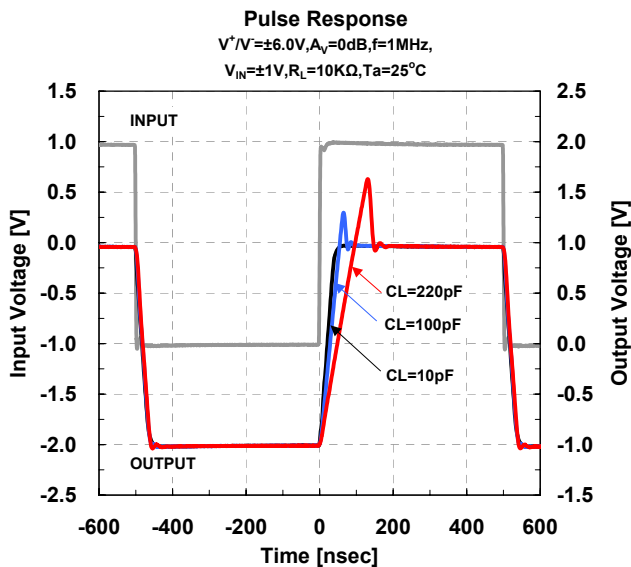
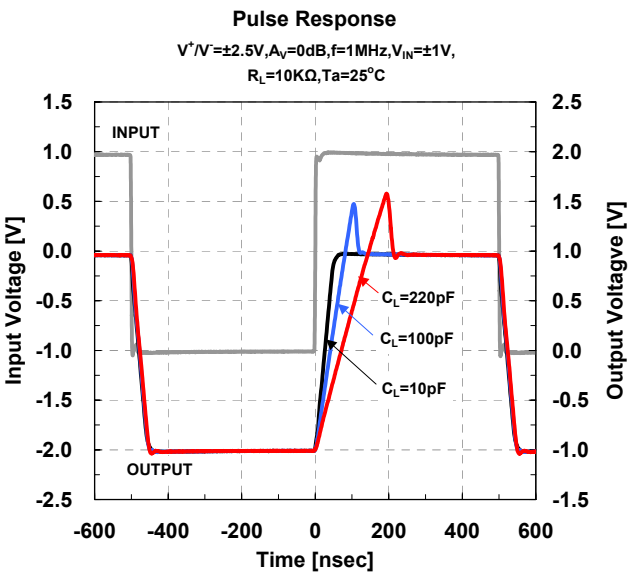
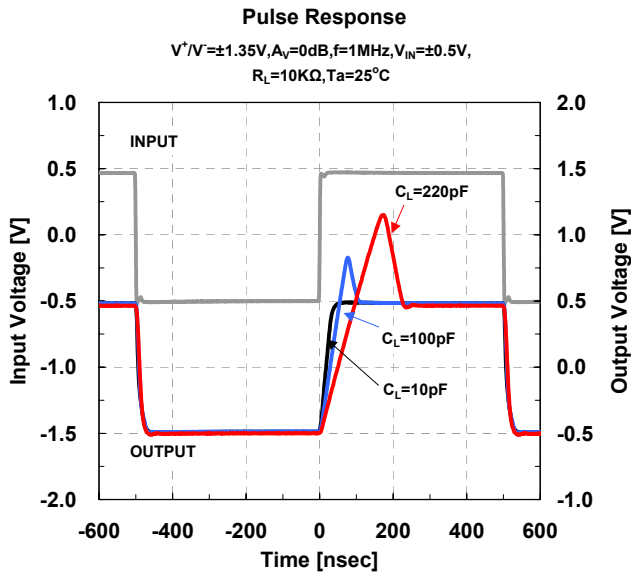
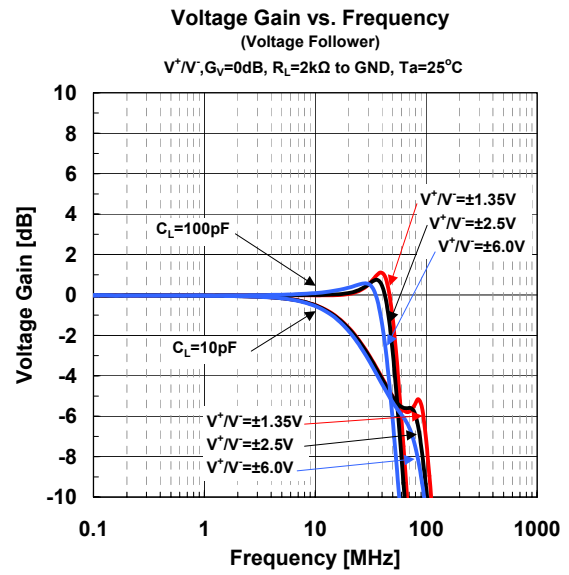
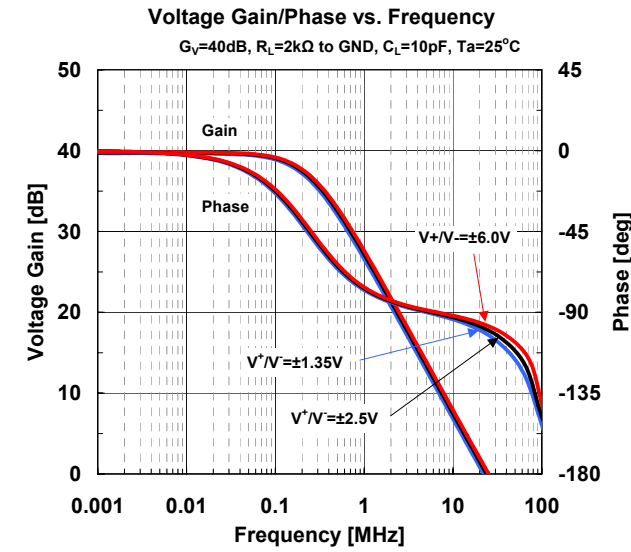

[CAUTION]
 The specifications on this data book are only given for information, without any guarantee as regards either mistakes or omissions. The application circuits in this data book are described only to show representative usages of the product and not intended for the guarantee or permission of any right including the industrial rights.

Mouser Electronics

Authorized Distributor

Click to View Pricing, Inventory, Delivery & Lifecycle Information:

[NJR:](#)

[NJM2717M-TE1](#) [NJM2717RB1-TE1](#)



Стандарт Электрон Связь

Мы молодая и активно развивающаяся компания в области поставок электронных компонентов. Мы поставляем электронные компоненты отечественного и импортного производства напрямую от производителей и с крупнейших складов мира.

Благодаря сотрудничеству с мировыми поставщиками мы осуществляем комплексные и плановые поставки широчайшего спектра электронных компонентов.

Собственная эффективная логистика и склад в обеспечивает надежную поставку продукции в точно указанные сроки по всей России.

Мы осуществляем техническую поддержку нашим клиентам и предпродажную проверку качества продукции. На все поставляемые продукты мы предоставляем гарантию .

Осуществляем поставки продукции под контролем ВП МО РФ на предприятия военно-промышленного комплекса России , а также работаем в рамках 275 ФЗ с открытием отдельных счетов в уполномоченном банке. Система менеджмента качества компании соответствует требованиям ГОСТ ISO 9001.

Минимальные сроки поставки, гибкие цены, неограниченный ассортимент и индивидуальный подход к клиентам являются основой для выстраивания долгосрочного и эффективного сотрудничества с предприятиями радиоэлектронной промышленности, предприятиями ВПК и научно-исследовательскими институтами России.

С нами вы становитесь еще успешнее!

Наши контакты:

Телефон: +7 812 627 14 35

Электронная почта: sales@st-electron.ru

Адрес: 198099, Санкт-Петербург,
Промышленная ул, дом № 19, литера Н,
помещение 100-Н Офис 331