



Features

- Carbon element
- Red, orange, green, amber and white LED colors
- Center detent option
- Assortment of resistance tapers
- Various travel lengths
- Various lever sizes



PTL Series Slide Potentiometer w/LED

Electrical Characteristics

Standard Resistance Range
 1K ohms to 1 megohm
 Standard Resistance Tolerance... ±20 %
 End Resistance
 20 mm Travel..... 10 ohms max.
 30 mm Travel..... 20 ohms max.
 45 mm Travel..... 20 ohms max.
 60 mm Travel..... 30 ohms max.
 Insulation Resistance @ 250 VDC
 100 megohms min.
 Dielectric Withstanding Voltage
 300 VAC
 Standard Taper Linear, Audio
 Power Rating - Linear
 20 mm Travel..... 0.05 watt
 30 mm Travel..... 0.1 watt
 45 mm Travel..... 0.125 watt
 60 mm Travel..... 0.2 watt
 Power Rating - Audio
 20 mm Travel..... 0.025 watt
 30 mm Travel..... 0.05 watt
 45 mm Travel..... 0.06 watt
 60 mm Travel..... 0.1 watt
 Slider Noise 200 mV max.

Environmental Characteristics

Operational Life 15,000 cycles
 TR Shift ±15 %
 Operating Temperature Range
 -10 °C to +55 °C
 Resistance to Solder Heat..... ±5 %

Mechanical Characteristics

Mechanical Travel..... Length ±0.5 mm
 Operating Force 30 gf to 250 gf
 Center Detent Force..... 20 gf to 200 gf
 Stop Strength 5 kgf min.
 Shaft Axial Force 5 kgf min.
 Shaft Wobble.. 2(2 x L/20) mm p-p max.
 Soldering Condition
 Manual 300 °C ±5 °C for 3 sec.
 Wave 260 °C ±5 °C for 5 sec.
 Wash Not recommended

Product Dimensions

20 mm Length of Travel

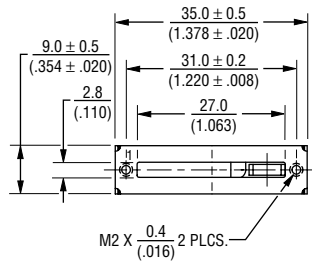

Lever Length
10.0 (.394)
15.0 (.591)
19.0 (.748)

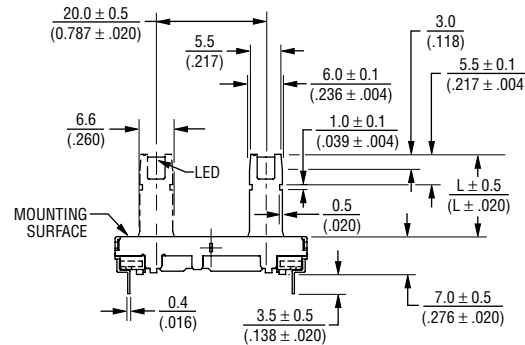

DIMENSIONS: $\frac{\text{MM}}{\text{(INCHES)}}$

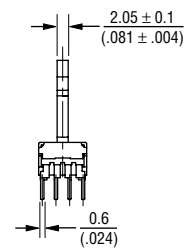

Mounting Hole Detail

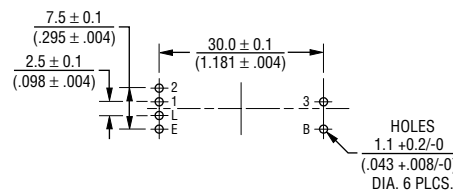

Standard Resistance Table

Resistance (Ohms)	Resistance Code
1,000	102
2,000	202
5,000	502
10,000	103
20,000	203
50,000	503
100,000	104
200,000	204
500,000	504
1,000,000	105

Schematic

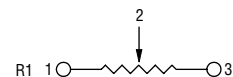

*RoHS Directive 2002/95/EC Jan 27, 2003 including Annex.
 Specifications are subject to change without notice.
 Customers should verify actual device performance in their specific applications.

Applications

- Mixing consoles
- Drum machines
- Keyboards and synthesizers
- Equalizers

PTL Series Slide Potentiometer w/LED

BOURNS®

Product Dimensions

30 mm Length of Travel

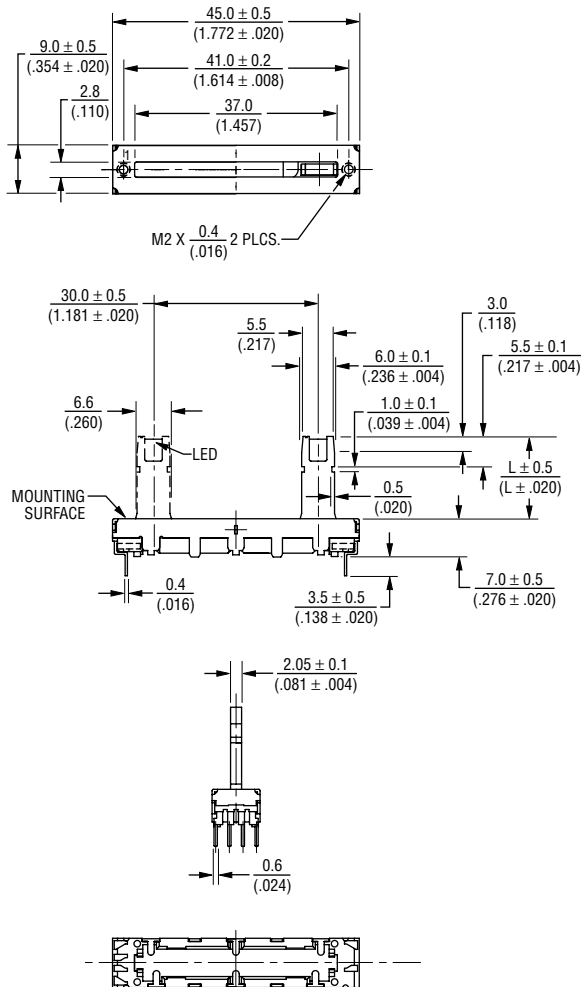

Mounting Hole Detail

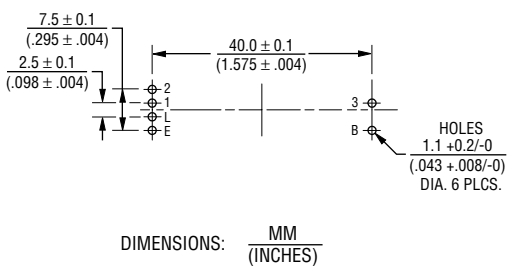

45 mm Length of Travel

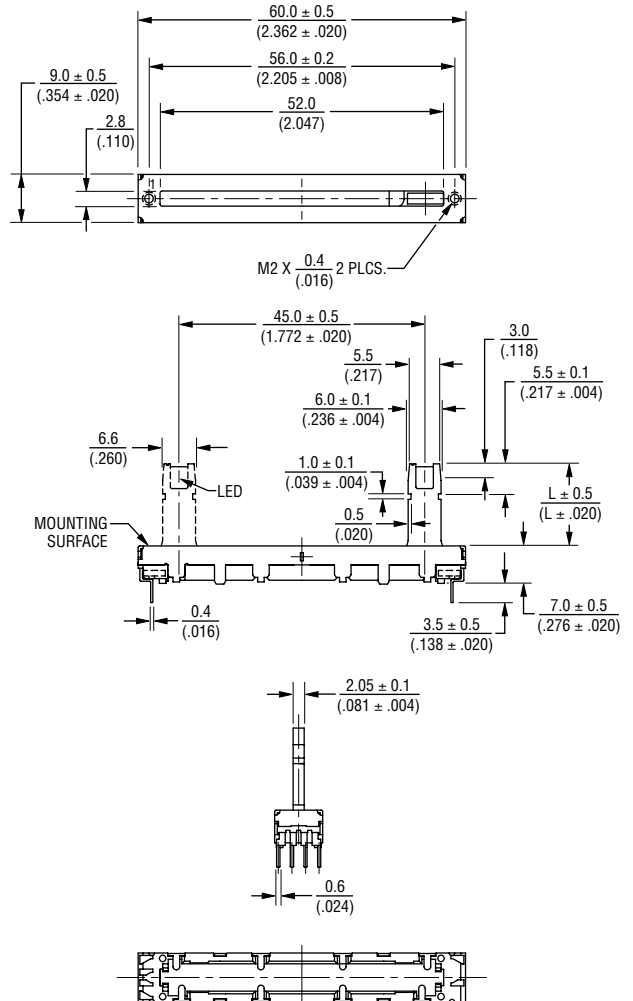

Mounting Hole Detail

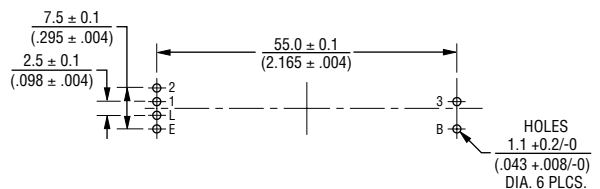

Specifications are subject to change without notice. Customers should verify actual device performance in their specific applications.

PTL Series Slide Potentiometer w/LED

BOURNS®

Product Dimensions

60 mm Length of Travel

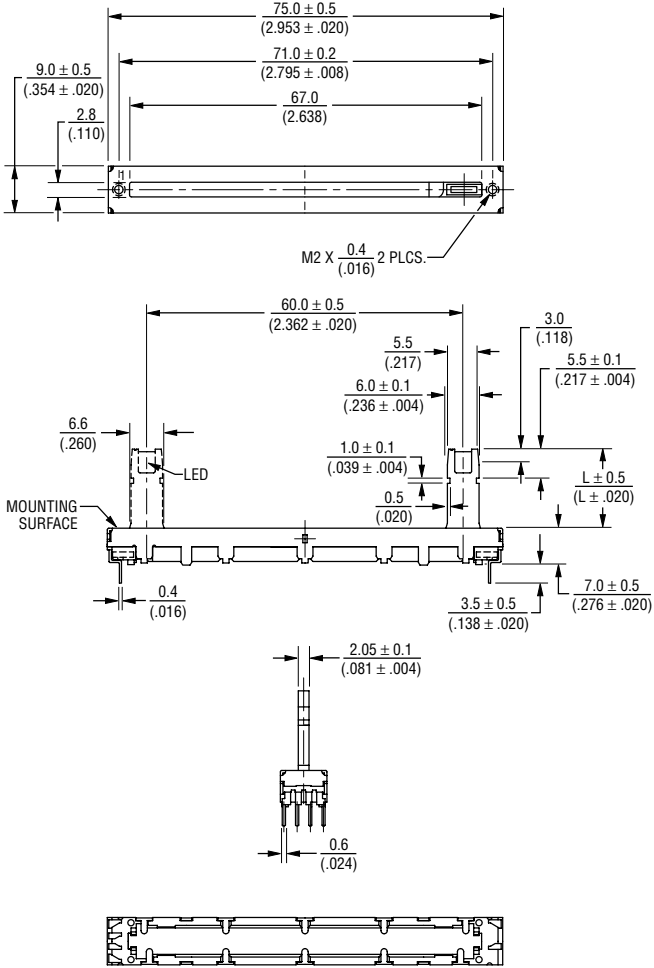

Mounting Hole Detail

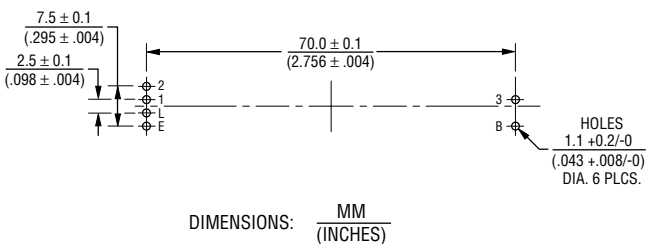

Tapers

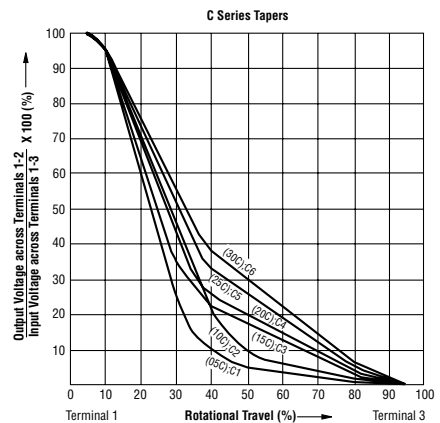
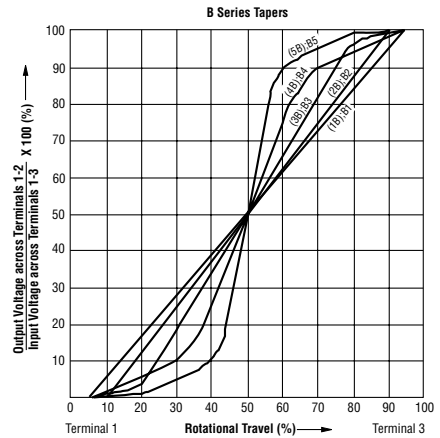
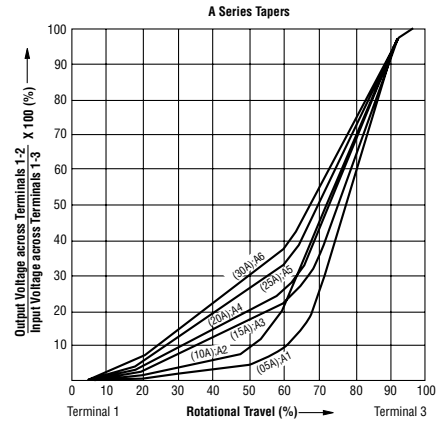

Specifications are subject to change without notice.
Customers should verify actual device performance in their specific applications.

PTL Series Slide Potentiometer w/LED

BOURNS®

LED Characteristics

Emitter Color	Item	Symbol	Test Conditions	Min.	Typ.	Max.	Unit
Red	Forward Voltage	V_F	$I_F = 20 \text{ mA}$		2.1	2.5	V
	Luminous Intensity	I_V		0.3	0.6		mcd
	Peak Emission Wavelength	λ_p			660		nm
	Dominant Wavelength	λ_d			643		nm
	Spectral Line Half Width	$\Delta\lambda$			20		nm
Orange	Forward Voltage	V_F	$I_F = 20 \text{ mA}$		2.2	2.5	V
	Luminous Intensity	I_V		1.5	3.0		mcd
	Peak Emission Wavelength	λ_p			610		nm
	Dominant Wavelength	λ_d			605		nm
	Spectral Line Half Width	$\Delta\lambda$			35		nm
Green	Forward Voltage	V_F	$I_F = 20 \text{ mA}$		2.1	2.5	V
	Luminous Intensity	I_V		0.6	1.2		mcd
	Peak Emission Wavelength	λ_p			530		nm
	Dominant Wavelength	λ_d			35		nm
	Spectral Line Half Width	$\Delta\lambda$			160		nm
Amber	Forward Voltage	V_F	$I_F = 20 \text{ mA}$		2.1	2.6	V
	Luminous Intensity	I_V			5.0		mcd
	Peak Emission Wavelength	λ_p			585		nm
	Dominant Wavelength	λ_d		582	-	595	nm
	Spectral Line Half Width	$\Delta\lambda$			35		nm
White	Forward Voltage	V_F	$I_F = 20 \text{ mA}$		3.5	4	V
	Luminous Intensity	I_V			300.0		mcd
	Peak Emission Wavelength	λ_p			520		nm
	Dominant Wavelength	λ_d		460	-	470	nm
	Spectral Line Half Width	$\Delta\lambda$			35		nm

How To Order

PTL 30 - 10 R 0 - 103 B2

Model Number Designator
 PTL = Slide Potentiometer w/LED

Length of Travel
 20 = 20 mm 45 = 45 mm
 30 = 30 mm 60 = 60 mm

Lever Length
 10 = 10 mm
 15 = 15 mm
 19 = 19 mm

LED Color
 R = Red A = Amber
 O = Orange W = White
 G = Green

Detent Option
 0 = No Detent
 1 = Center Detent

Resistance Code
 (See Standard Resistance Table)

Resistance Taper (See Taper Charts)
 Taper Series followed by Curve Number

Circuit

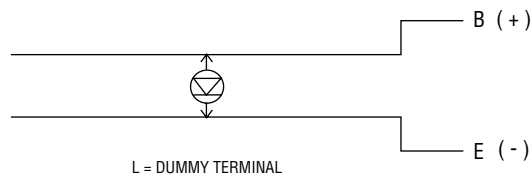

REV. 09/11

Specifications are subject to change without notice. Customers should verify actual device performance in their specific applications.



Стандарт Электрон Связь

Мы молодая и активно развивающаяся компания в области поставок электронных компонентов. Мы поставляем электронные компоненты отечественного и импортного производства напрямую от производителей и с крупнейших складов мира.

Благодаря сотрудничеству с мировыми поставщиками мы осуществляем комплексные и плановые поставки широчайшего спектра электронных компонентов.

Собственная эффективная логистика и склад в обеспечивает надежную поставку продукции в точно указанные сроки по всей России.

Мы осуществляем техническую поддержку нашим клиентам и предпродажную проверку качества продукции. На все поставляемые продукты мы предоставляем гарантию .

Осуществляем поставки продукции под контролем ВП МО РФ на предприятия военно-промышленного комплекса России , а также работаем в рамках 275 ФЗ с открытием отдельных счетов в уполномоченном банке. Система менеджмента качества компании соответствует требованиям ГОСТ ISO 9001.

Минимальные сроки поставки, гибкие цены, неограниченный ассортимент и индивидуальный подход к клиентам являются основой для выстраивания долгосрочного и эффективного сотрудничества с предприятиями радиоэлектронной промышленности, предприятиями ВПК и научно-исследовательскими институтами России.

С нами вы становитесь еще успешнее!

Наши контакты:

Телефон: +7 812 627 14 35

Электронная почта: sales@st-electron.ru

Адрес: 198099, Санкт-Петербург,
Промышленная ул, дом № 19, литера Н,
помещение 100-Н Офис 331