

74CBTLV3306

2-bit bus switch

Rev. 1 — 7 December 2016

Product data sheet

1. General description

The 74CBTLV3306 is a 2-bit high-speed bus switch with separate output enable inputs ($\overline{\text{nOE}}$). Each switch is disabled when the associated output enable ($\overline{\text{nOE}}$) input is HIGH.

To ensure the high-impedance OFF-state during power-up or power-down, $\overline{\text{nOE}}$ should be tied to the V_{CC} through a pull-up resistor. The minimum value of the resistor is determined by the current-sinking capability of the driver.

Schmitt trigger action at control input makes the circuit tolerant to slower input rise and fall times across the entire V_{CC} range from 2.3 V to 3.6 V.

This device is fully specified for partial power-down applications using I_{OFF} . The I_{OFF} circuitry disables the output, preventing the damaging backflow current through the device when it is powered down.

2. Features and benefits

- Supply voltage range from 2.3 V to 3.6 V
- High noise immunity
- Complies with JEDEC standard:
 - ◆ JESD8-5 (2.3 V to 2.7 V)
 - ◆ JESD8-B/JESD36 (2.7 V to 3.6 V)
- ESD protection:
 - ◆ HBM JESD22-A114F exceeds 2000 V
 - ◆ MM JESD22-A115-A exceeds 200 V
 - ◆ CDM AEC-Q100-011 revision B exceeds 1000 V
- 4 Ω switch connection between two ports
- Rail to rail switching on data I/O ports
- CMOS low power consumption
- Latch-up performance exceeds 250 mA per JESD78B Class I level A
- I_{OFF} circuitry provides partial Power-down mode operation
- Multiple package options
- Specified from $-40\text{ }^{\circ}\text{C}$ to $+85\text{ }^{\circ}\text{C}$ and $-40\text{ }^{\circ}\text{C}$ to $+125\text{ }^{\circ}\text{C}$

3. Ordering information

Table 1. Ordering information

Type number	Package			Version
	Temperature range	Name	Description	
74CBTLV3306DC	-40 °C to +125 °C	VSSOP8	plastic very thin shrink small outline package; 8 leads; body width 2.3 mm	SOT765-1
74CBTLV3306GT	-40 °C to +125 °C	XSON8	plastic extremely thin small outline package; no leads; 8 terminals; body 1 × 1.95 × 0.5 mm	SOT833-1

4. Marking

Table 2. Marking codes

Type number	Marking code ^[1]
74CBTLV3306DC	b6
74CBTLV3306GT	b6

[1] The pin 1 indicator is located on the lower left corner of the device, below the marking code.

5. Functional diagram

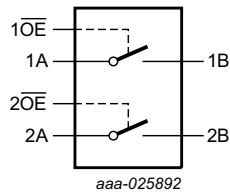

Fig 1. Logic symbol

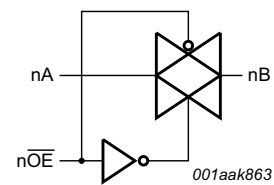
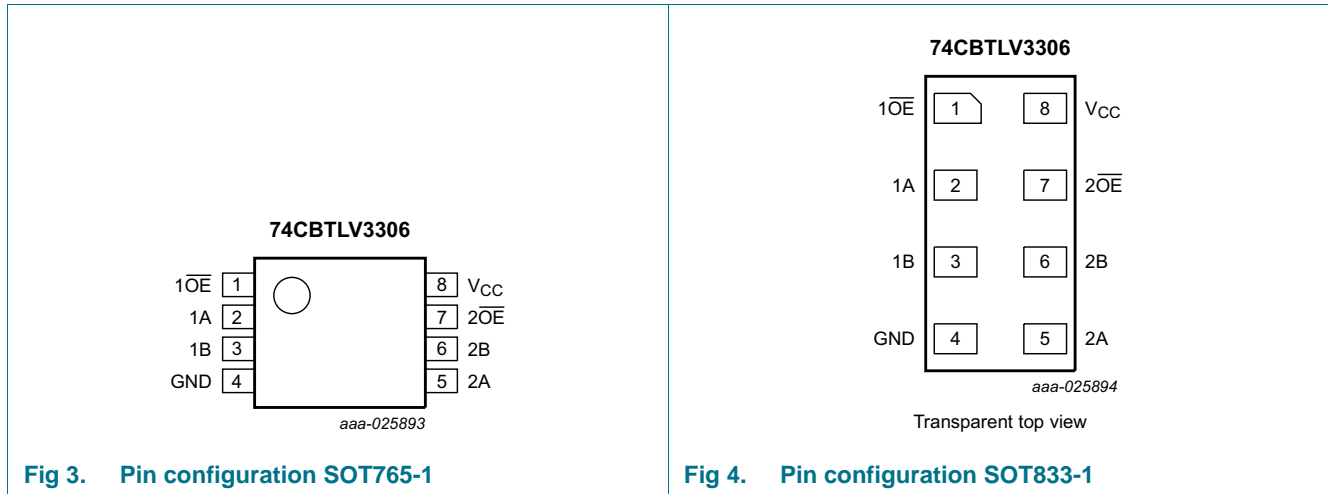

Fig 2. Logic diagram (one switch)

6. Pinning information

6.1 Pinning



6.2 Pin description

Table 3. Pin description

Symbol	Pin	Description
$1\overline{OE}$, $2\overline{OE}$	1, 7	output enable input
1A, 2A	2, 5	data input/output (A port)
1B, 2B	3, 6	data input/output (B port)
GND	4	ground (0 V)
V _{CC}	8	positive supply voltage

7. Functional description

Table 4. Function selection^[1]

Input	Input/output
$n\overline{OE}$	nA, nB
L	nA = nB
H	Z

[1] H = HIGH voltage level; L = LOW voltage level; Z = high-impedance OFF-state.

8. Limiting values

Table 5. Limiting values

In accordance with the Absolute Maximum Rating System (IEC 60134). Voltages are referenced to GND (ground = 0 V).

Symbol	Parameter	Conditions	Min	Max	Unit
V_{CC}	supply voltage		-0.5	+4.6	V
V_I	input voltage	control inputs [1]	-0.5	+4.6	V
V_{SW}	switch voltage	enable and disable mode [2]	-0.5	$V_{CC} + 0.5$	V
I_{IK}	input clamping current	$V_I < -0.5$ V	-50	-	mA
I_{SK}	switch clamping current	$V_I < -0.5$ V	-50	-	mA
I_{SW}	switch current	$V_{SW} = 0$ V to V_{CC}	-	± 128	mA
I_{CC}	supply current		-	+100	mA
I_{GND}	ground current		-100	-	mA
T_{stg}	storage temperature		-65	+150	°C
P_{tot}	total power dissipation	$T_{amb} = -40$ °C to +125 °C [3]	-	500	mW

[1] The minimum input voltage rating may be exceeded if the input clamping current ratings are observed.

[2] The switch voltage ratings may be exceeded if switch clamping current ratings are observed

[3] For VSSOP8 packages: above 110 °C, the value of P_{tot} derates linearly with 8.0 mW/K.

For XSON8 packages: above 118 °C the value of P_{tot} derates linearly with 7.8 mW/K.

9. Recommended operating conditions

Table 6. Recommended operating conditions

Symbol	Parameter	Conditions	Min	Max	Unit
V_{CC}	supply voltage		2.3	3.6	V
V_I	input voltage	control inputs	0	3.6	V
V_{SW}	switch voltage	enable and disable mode	0	V_{CC}	V
T_{amb}	ambient temperature		-40	+125	°C
$\Delta t/\Delta V$	input transition rise and fall rate	pin \overline{nOE} ; $V_{CC} = 2.3$ V to 3.6 V	0	200	ns/V

10. Static characteristics

Table 7. Static characteristics

At recommended operating conditions voltages are referenced to GND (ground = 0 V).

Symbol	Parameter	Conditions	$T_{amb} = -40$ °C to +85 °C			$T_{amb} = -40$ °C to +125 °C		Unit
			Min	Typ [1]	Max	Min	Max	
V_{IH}	HIGH-level input voltage	$V_{CC} = 2.3$ V to 2.7 V	1.7	-	-	1.7	-	V
		$V_{CC} = 3.0$ V to 3.6 V	2.0	-	-	2.0	-	V
V_{IL}	LOW-level input voltage	$V_{CC} = 2.3$ V to 2.7 V	-	-	0.7	-	0.7	V
		$V_{CC} = 3.0$ V to 3.6 V	-	-	0.9	-	0.9	V
I_I	input leakage current	pin \overline{nOE} ; $V_I = GND$ to V_{CC} ; $V_{CC} = 3.6$ V	-	-	± 1.0	-	± 20	μ A
$I_{S(OFF)}$	OFF-state leakage current	$V_{CC} = 3.6$ V; see Figure 5	-	-	± 1	-	± 20	μ A

Table 7. Static characteristics ...continued

At recommended operating conditions voltages are referenced to GND (ground = 0 V).

Symbol	Parameter	Conditions	T _{amb} = -40 °C to +85 °C			T _{amb} = -40 °C to +125 °C		Unit
			Min	Typ ^[1]	Max	Min	Max	
I _{S(ON)}	ON-state leakage current	V _{CC} = 3.6 V; see Figure 6	-	-	±1	-	±20	μA
I _{OFF}	power-off leakage current	V _I or V _O = 0 V to 3.6 V; V _{CC} = 0 V	-	-	±10	-	±50	μA
I _{CC}	supply current	V _I = GND or V _{CC} ; I _O = 0 A; V _{SW} = GND or V _{CC} ; V _{CC} = 3.6 V	-	-	10	-	50	μA
ΔI _{CC}	additional supply current	pin n $\overline{\text{OE}}$; V _I = V _{CC} - 0.6 V; ^[2] V _{SW} = GND or V _{CC} ; V _{CC} = 3.6 V	-	-	300	-	2000	μA
C _I	input capacitance	pin n $\overline{\text{OE}}$; V _{CC} = 3.3 V; V _I = 0 V to 3.3 V	-	0.9	-	-	-	pF
C _{S(OFF)}	OFF-state capacitance	V _{CC} = 3.3 V; V _I = 0 V to 3.3 V	-	3.0	-	-	-	pF
C _{S(ON)}	ON-state capacitance	V _{CC} = 3.3 V; V _I = 0 V to 3.3 V	-	10.6	-	-	-	pF

[1] All typical values are measured at T_{amb} = 25 °C.[2] One input at 3 V, other inputs at V_{CC} or GND.

10.1 Test circuits

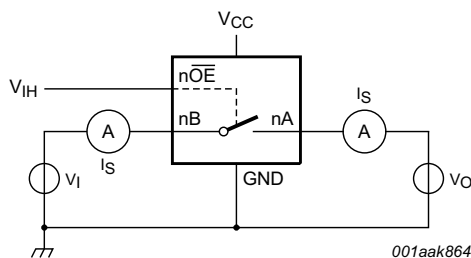
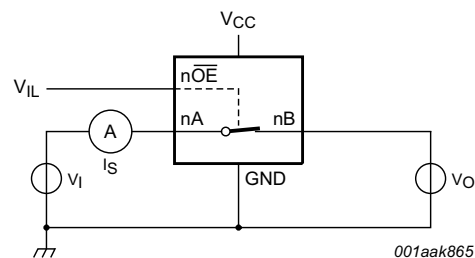
V_I = V_{CC} or GND and V_O = GND or V_{CC}.**Fig 5. Test circuit for measuring OFF-state leakage current (one switch)**V_I = V_{CC} or GND and V_O = open circuit.**Fig 6. Test circuit for measuring ON-state leakage current (one switch)**

10.2 ON resistance

Table 8. Resistance R_{ON}

At recommended operating conditions; voltages are referenced to GND (ground = 0 V); for test circuit see Figure 7.

Symbol	Parameter	Conditions	$T_{amb} = -40\text{ }^{\circ}\text{C to }+85\text{ }^{\circ}\text{C}$			$T_{amb} = -40\text{ }^{\circ}\text{C to }+125\text{ }^{\circ}\text{C}$		Unit
			Min	Typ ^[1]	Max	Min	Max	
R_{ON}	ON resistance	$V_{CC} = 2.3\text{ V to }2.7\text{ V};$ see Figure 8 to Figure 10 ^[2]						
		$I_{SW} = 64\text{ mA}; V_I = 0\text{ V}$	-	3.6	8.0	-	15.0	Ω
		$I_{SW} = 24\text{ mA}; V_I = 0\text{ V}$	-	3.6	8.0	-	15.0	Ω
		$I_{SW} = 15\text{ mA}; V_I = 1.7\text{ V}$	-	6.6	40.0	-	60.0	Ω
		$V_{CC} = 3.0\text{ V to }3.6\text{ V};$ see Figure 11 to Figure 13						
		$I_{SW} = 64\text{ mA}; V_I = 0\text{ V}$	-	3.5	7.0	-	11.0	Ω
		$I_{SW} = 24\text{ mA}; V_I = 0\text{ V}$	-	3.5	7.0	-	11.0	Ω
		$I_{SW} = 15\text{ mA}; V_I = 2.4\text{ V}$	-	4.6	15.0	-	25.5	Ω

- [1] Typical values are measured at $T_{amb} = 25\text{ }^{\circ}\text{C}$ and nominal V_{CC} .
- [2] Measured by the voltage drop between the A and B terminals at the indicated current through the switch. ON-state resistance is determined by the lower of the voltages of the two (A or B) terminals.

10.3 ON resistance test circuit and graphs

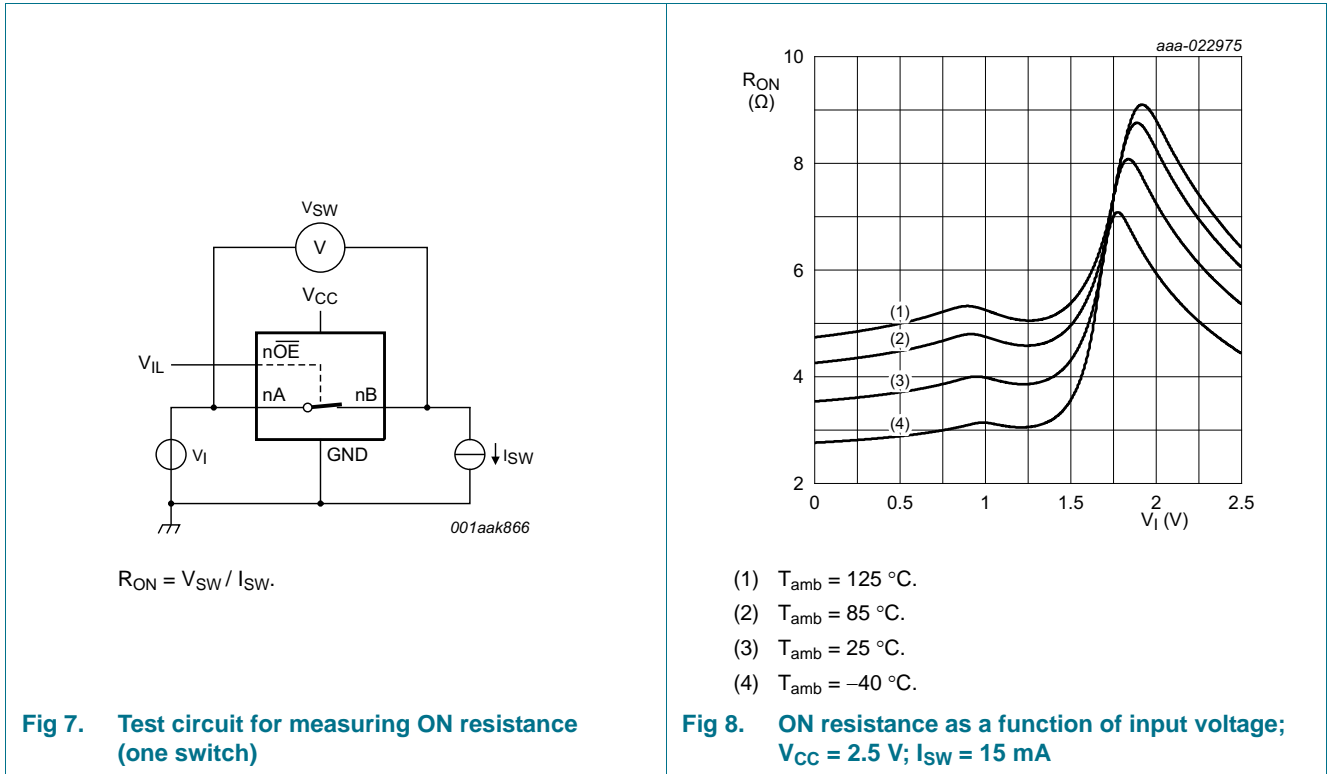

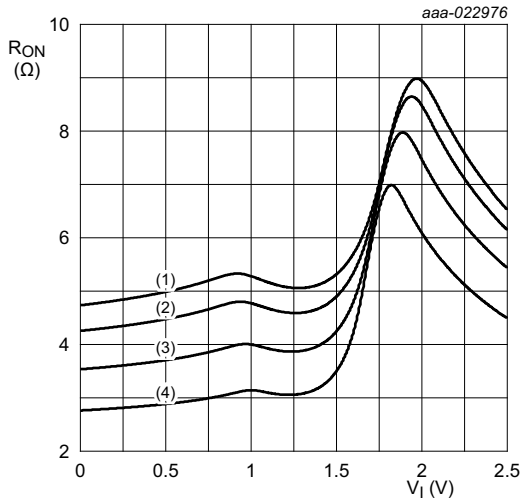

- (1) $T_{amb} = 125\text{ }^{\circ}\text{C}.$
- (2) $T_{amb} = 85\text{ }^{\circ}\text{C}.$
- (3) $T_{amb} = 25\text{ }^{\circ}\text{C}.$
- (4) $T_{amb} = -40\text{ }^{\circ}\text{C}.$

Fig 9. ON resistance as a function of input voltage;
 $V_{CC} = 2.5\text{ V}; I_{SW} = 24\text{ mA}$

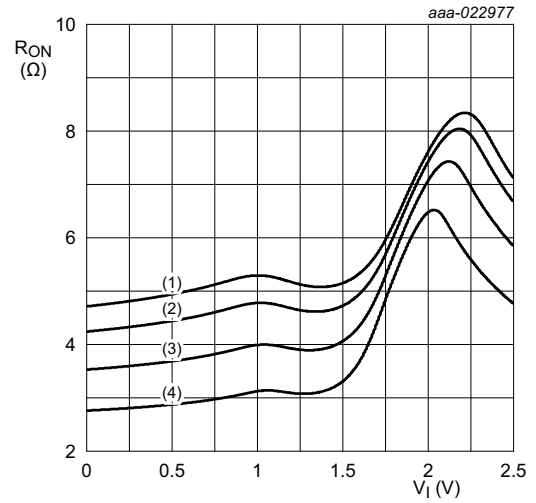

- (1) $T_{amb} = 125\text{ }^{\circ}\text{C}.$
- (2) $T_{amb} = 85\text{ }^{\circ}\text{C}.$
- (3) $T_{amb} = 25\text{ }^{\circ}\text{C}.$
- (4) $T_{amb} = -40\text{ }^{\circ}\text{C}.$

Fig 10. ON resistance as a function of input voltage;
 $V_{CC} = 2.5\text{ V}; I_{SW} = 64\text{ mA}$

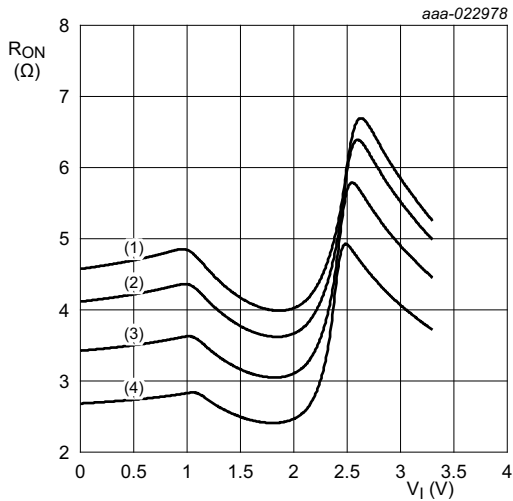

- (1) $T_{amb} = 125\text{ }^{\circ}\text{C}.$
- (2) $T_{amb} = 85\text{ }^{\circ}\text{C}.$
- (3) $T_{amb} = 25\text{ }^{\circ}\text{C}.$
- (4) $T_{amb} = -40\text{ }^{\circ}\text{C}.$

Fig 11. ON resistance as a function of input voltage;
 $V_{CC} = 3.3\text{ V}; I_{SW} = 15\text{ mA}$

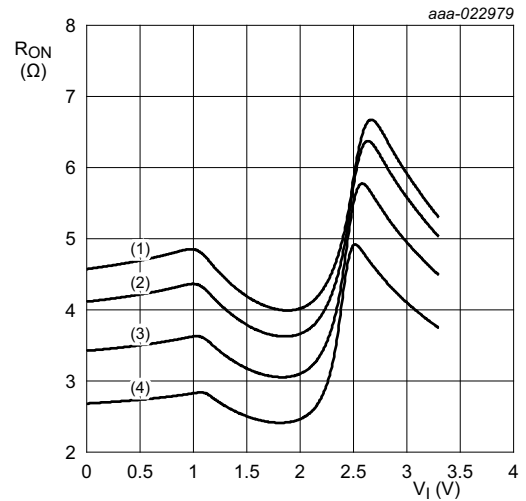

- (1) $T_{amb} = 125\text{ }^{\circ}\text{C}.$
- (2) $T_{amb} = 85\text{ }^{\circ}\text{C}.$
- (3) $T_{amb} = 25\text{ }^{\circ}\text{C}.$
- (4) $T_{amb} = -40\text{ }^{\circ}\text{C}.$

Fig 12. ON resistance as a function of input voltage;
 $V_{CC} = 3.3\text{ V}; I_{SW} = 24\text{ mA}$

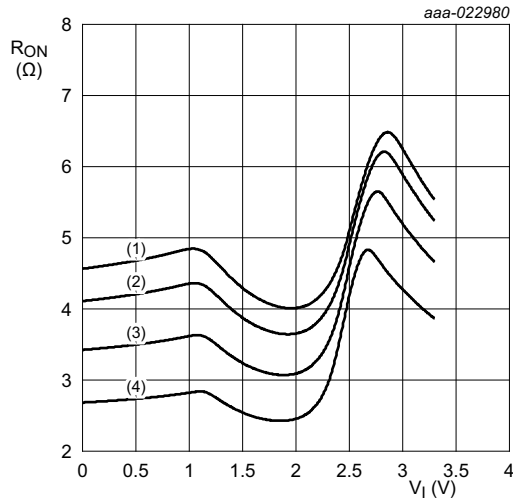

- (1) $T_{amb} = 125\text{ }^{\circ}\text{C}$.
- (2) $T_{amb} = 85\text{ }^{\circ}\text{C}$.
- (3) $T_{amb} = 25\text{ }^{\circ}\text{C}$.
- (4) $T_{amb} = -40\text{ }^{\circ}\text{C}$.

Fig 13. ON resistance as a function of input voltage; $V_{CC} = 3.3\text{ V}$; $I_{SW} = 64\text{ mA}$

11. Dynamic characteristics

Table 9. Dynamic characteristics

$GND = 0\text{ V}$; for test circuit see [Figure 16](#)

Symbol	Parameter	Conditions	$T_{amb} = -40\text{ }^{\circ}\text{C to } +85\text{ }^{\circ}\text{C}$			$T_{amb} = -40\text{ }^{\circ}\text{C to } +125\text{ }^{\circ}\text{C}$		Unit
			Min	Typ ^[1]	Max	Min	Max	
t_{pd}	propagation delay	nA to nB or nB to nA; see Figure 14 ^{[2][3]}						
		$V_{CC} = 2.3\text{ V to } 2.7\text{ V}$	-	-	0.13	-	0.20	ns
		$V_{CC} = 3.0\text{ V to } 3.6\text{ V}$	-	-	0.20	-	0.31	ns
t_{en}	enable time	$\overline{\text{nOE}}$ to nA or nB; see Figure 15 ^[4]						
		$V_{CC} = 2.3\text{ V to } 2.7\text{ V}$	1.0	2.7	4.6	1.0	6.0	ns
		$V_{CC} = 3.0\text{ V to } 3.6\text{ V}$	1.0	2.4	4.4	1.0	6.0	ns
t_{dis}	disable time	$\overline{\text{nOE}}$ to nA or nB; see Figure 15 ^[5]						
		$V_{CC} = 2.3\text{ V to } 2.7\text{ V}$	1.0	2.2	3.9	1.0	5.5	ns
		$V_{CC} = 3.0\text{ V to } 3.6\text{ V}$	1.0	2.9	4.2	1.0	5.5	ns

- [1] All typical values are measured at $T_{amb} = 25\text{ }^{\circ}\text{C}$ and at nominal V_{CC} .
- [2] The propagation delay is the calculated RC time constant of the typical ON resistance of the switch and the load capacitance, when driven by an ideal voltage source (zero output impedance).
- [3] t_{pd} is the same as t_{PLH} and t_{PHL} .
- [4] t_{en} is the same as t_{PZH} and t_{PZL} .
- [5] t_{dis} is the same as t_{PHZ} and t_{PLZ} .

12. Waveforms

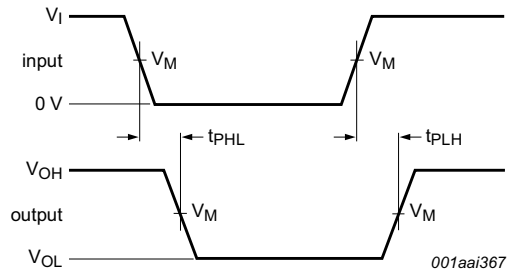

Measurement points are given in [Table 10](#).

Logic levels: V_{OL} and V_{OH} are typical output voltage levels that occur with the output load.

Fig 14. The data input (nA or nB) to output (nB or nA) propagation delays

Table 10. Measurement points

Supply voltage	Input			Output		
V_{CC}	V_M	V_I	$t_r = t_f$	V_M	V_X	V_Y
2.3 V to 2.7 V	$0.5V_{CC}$	V_{CC}	≤ 2.0 ns	$0.5V_{CC}$	$V_{OL} + 0.15$ V	$V_{OH} - 0.15$ V
3.0 V to 3.6 V	$0.5V_{CC}$	V_{CC}	≤ 2.0 ns	$0.5V_{CC}$	$V_{OL} + 0.3$ V	$V_{OH} - 0.3$ V

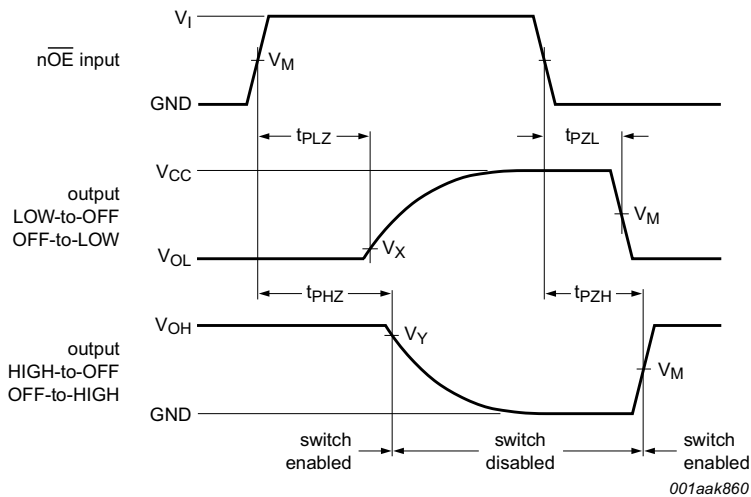

Measurement points are given in [Table 10](#).

Logic levels: V_{OL} and V_{OH} are typical output voltage levels that occur with the output load.

Fig 15. Enable and disable times

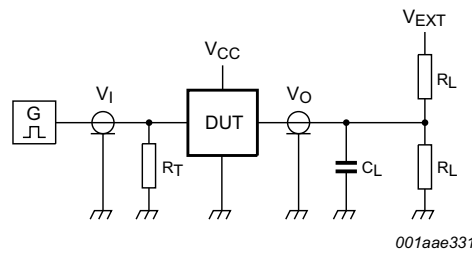
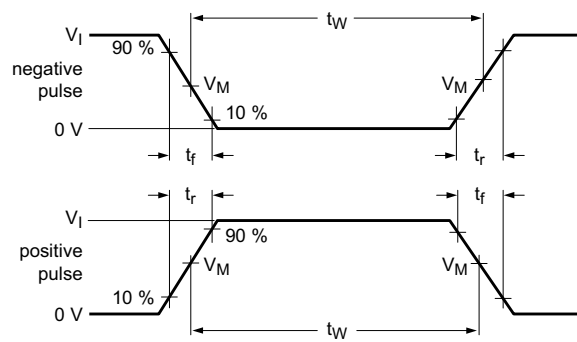

Test data is given in [Table 11](#).

Definitions for test circuit:

R_L = Load resistance.

C_L = Load capacitance including jig and probe capacitance.

R_T = Termination resistance should be equal to the output impedance Z_o of the pulse generator.

V_{EXT} = External voltage for measuring switching times.

Fig 16. Test circuit for measuring switching times

Table 11. Test data

Supply voltage	Load		V_{EXT}		
V_{CC}	C_L	R_L	t_{PLH}, t_{PHL}	t_{PZH}, t_{PHZ}	t_{PZL}, t_{PLZ}
2.3 V to 2.7 V	30 pF	500 Ω	open	GND	$2V_{CC}$
3.0 V to 3.6 V	50 pF	500 Ω	open	GND	$2V_{CC}$

12.1 Additional dynamic characteristics

Table 12. Additional dynamic characteristics

At recommended operating conditions; voltages are referenced to GND (ground = 0 V); $V_I = \text{GND}$ or V_{CC} (unless otherwise specified); $t_r = t_f \leq 2.5 \text{ ns}$.

Symbol	Parameter	Conditions	$T_{\text{amb}} = 25 \text{ }^\circ\text{C}$			Unit
			Min	Typ	Max	
$f_{(-3\text{dB})}$	-3 dB frequency response	$V_{CC} = 3.3 \text{ V}$; $R_L = 50 \text{ } \Omega$; see Figure 17 [1]	-	423	-	MHz

[1] f_i is biased at $0.5V_{CC}$.

12.2 Test circuits

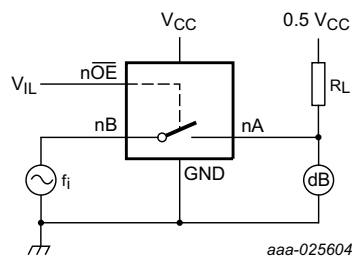

$\overline{\text{nOE}}$ connected to GND; Adjust f_i voltage to obtain 0 dBm level at output. Increase f_i frequency until dB meter reads -3 dB.

Fig 17. Test circuit for measuring the frequency response when channel is in ON-state

13. Package outline

VSSOP8: plastic very thin shrink small outline package; 8 leads; body width 2.3 mm

SOT765-1

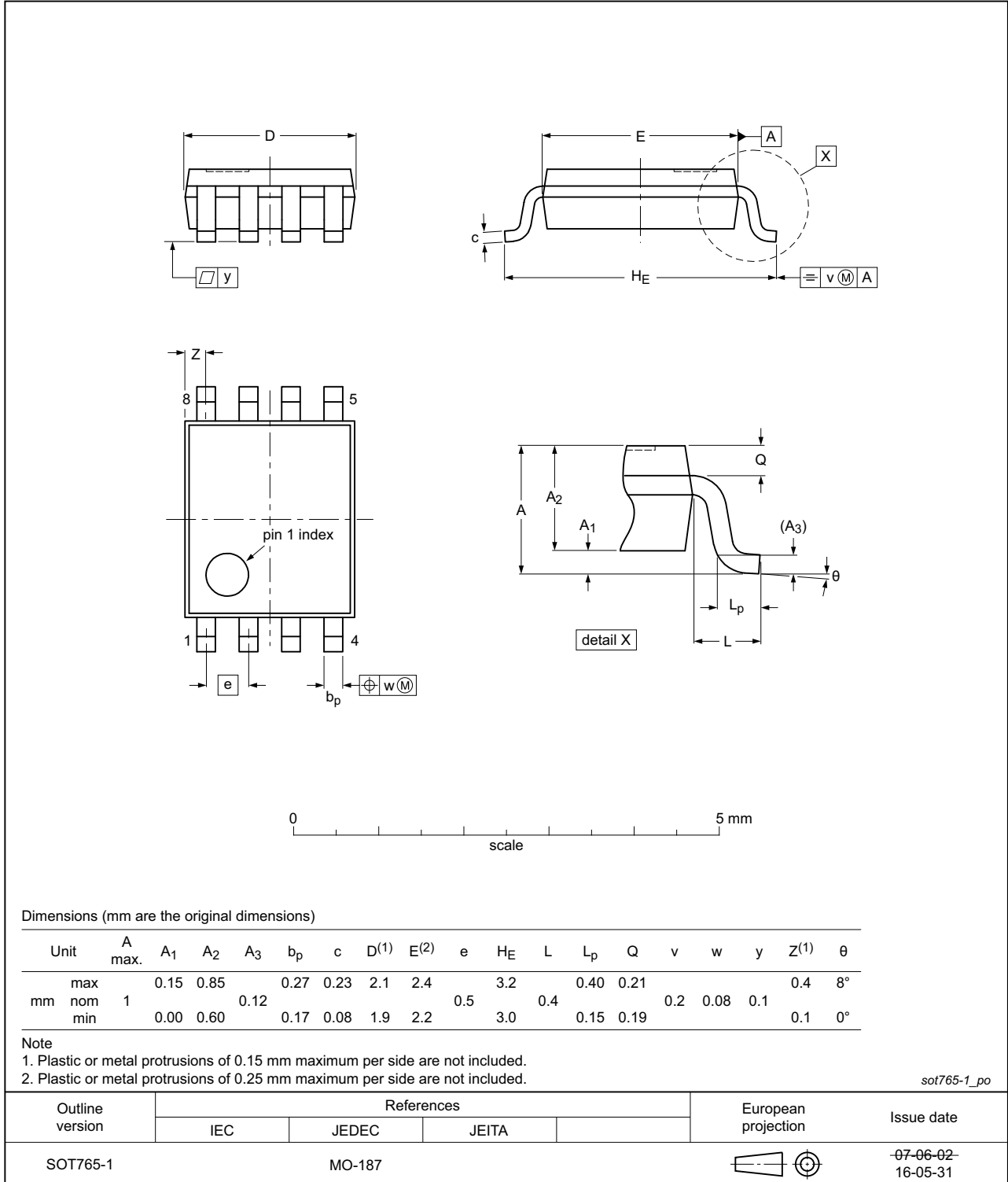

Fig 18. Package outline SOT765-1 (VSSOP8)

XSON8: plastic extremely thin small outline package; no leads; 8 terminals; body 1 x 1.95 x 0.5 mm

SOT833-1

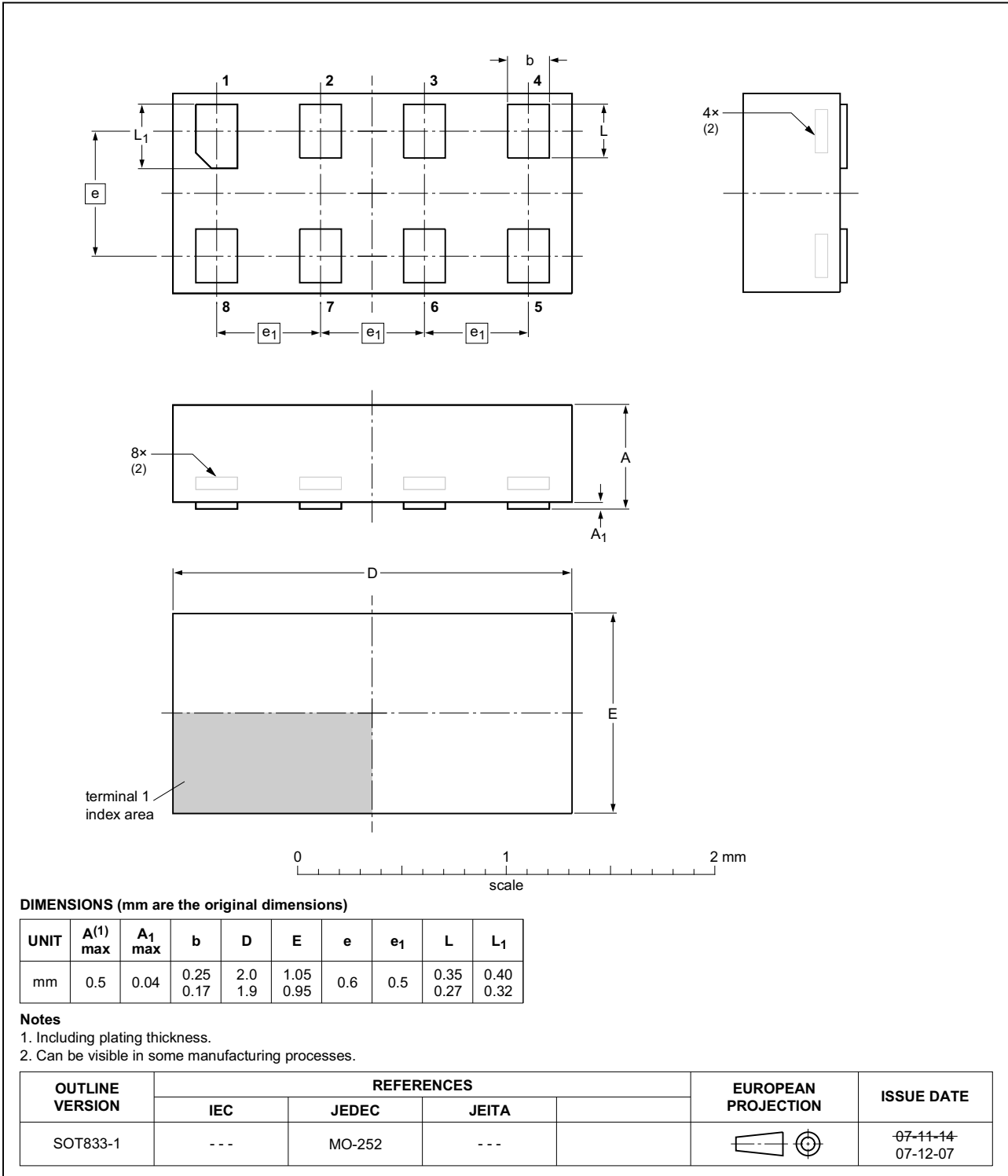

Fig 19. Package outline SOT833-1 (XSON8)

14. Abbreviations

Table 13. Abbreviations

Acronym	Description
CDM	Charged Device Model
CMOS	Complementary Metal-Oxide Semiconductor
DUT	Device Under Test
ESD	ElectroStatic Discharge
FET	Field Effect Transistor
HBM	Human Body Model
MM	Machine Model

15. Revision history

Table 14. Revision history

Document ID	Release date	Data sheet status	Change notice	Supersedes
74CBTLV3306 v.1	20161207	Product data sheet	-	-

16. Legal information

16.1 Data sheet status

Document status ^{[1][2]}	Product status ^[3]	Definition
Objective [short] data sheet	Development	This document contains data from the objective specification for product development.
Preliminary [short] data sheet	Qualification	This document contains data from the preliminary specification.
Product [short] data sheet	Production	This document contains the product specification.

[1] Please consult the most recently issued document before initiating or completing a design.

[2] The term 'short data sheet' is explained in section "Definitions".

[3] The product status of device(s) described in this document may have changed since this document was published and may differ in case of multiple devices. The latest product status information is available on the Internet at URL <http://www.nexperia.com>.

16.2 Definitions

Draft — The document is a draft version only. The content is still under internal review and subject to formal approval, which may result in modifications or additions. Nexperia does not give any representations or warranties as to the accuracy or completeness of information included herein and shall have no liability for the consequences of use of such information.

Short data sheet — A short data sheet is an extract from a full data sheet with the same product type number(s) and title. A short data sheet is intended for quick reference only and should not be relied upon to contain detailed and full information. For detailed and full information see the relevant full data sheet, which is available on request via the local Nexperia sales office. In case of any inconsistency or conflict with the short data sheet, the full data sheet shall prevail.

Product specification — The information and data provided in a Product data sheet shall define the specification of the product as agreed between Nexperia and its customer, unless Nexperia and customer have explicitly agreed otherwise in writing. In no event however, shall an agreement be valid in which the Nexperia product is deemed to offer functions and qualities beyond those described in the Product data sheet.

16.3 Disclaimers

Limited warranty and liability — Information in this document is believed to be accurate and reliable. However, Nexperia does not give any representations or warranties, expressed or implied, as to the accuracy or completeness of such information and shall have no liability for the consequences of use of such information. Nexperia takes no responsibility for the content in this document if provided by an information source outside of Nexperia.

In no event shall Nexperia be liable for any indirect, incidental, punitive, special or consequential damages (including - without limitation - lost profits, lost savings, business interruption, costs related to the removal or replacement of any products or rework charges) whether or not such damages are based on tort (including negligence), warranty, breach of contract or any other legal theory.

Notwithstanding any damages that customer might incur for any reason whatsoever, Nexperia's aggregate and cumulative liability towards customer for the products described herein shall be limited in accordance with the *Terms and conditions of commercial sale* of Nexperia.

Right to make changes — Nexperia reserves the right to make changes to information published in this document, including without limitation specifications and product descriptions, at any time and without notice. This document supersedes and replaces all information supplied prior to the publication hereof.

Suitability for use — Nexperia products are not designed, authorized or warranted to be suitable for use in life support, life-critical or safety-critical systems or equipment, nor in applications where failure or malfunction of a Nexperia product can reasonably be expected to result in personal injury, death or severe property or environmental damage. Nexperia and its suppliers accept no liability for inclusion and/or use of Nexperia products in such equipment or applications and therefore such inclusion and/or use is at the customer's own risk.

Applications — Applications that are described herein for any of these products are for illustrative purposes only. Nexperia makes no representation or warranty that such applications will be suitable for the specified use without further testing or modification.

Customers are responsible for the design and operation of their applications and products using Nexperia products, and Nexperia accepts no liability for any assistance with applications or customer product design. It is customer's sole responsibility to determine whether the Nexperia product is suitable and fit for the customer's applications and products planned, as well as for the planned application and use of customer's third party customer(s). Customers should provide appropriate design and operating safeguards to minimize the risks associated with their applications and products.

Nexperia does not accept any liability related to any default, damage, costs or problem which is based on any weakness or default in the customer's applications or products, or the application or use by customer's third party customer(s). Customer is responsible for doing all necessary testing for the customer's applications and products using Nexperia products in order to avoid a default of the applications and the products or of the application or use by customer's third party customer(s). Nexperia does not accept any liability in this respect.

Limiting values — Stress above one or more limiting values (as defined in the Absolute Maximum Ratings System of IEC 60134) will cause permanent damage to the device. Limiting values are stress ratings only and (proper) operation of the device at these or any other conditions above those given in the Recommended operating conditions section (if present) or the Characteristics sections of this document is not warranted. Constant or repeated exposure to limiting values will permanently and irreversibly affect the quality and reliability of the device.

Terms and conditions of commercial sale — Nexperia products are sold subject to the general terms and conditions of commercial sale, as published at <http://www.nexperia.com/profile/terms>, unless otherwise agreed in a valid written individual agreement. In case an individual agreement is concluded only the terms and conditions of the respective agreement shall apply. Nexperia hereby expressly objects to applying the customer's general terms and conditions with regard to the purchase of Nexperia products by customer.

No offer to sell or license — Nothing in this document may be interpreted or construed as an offer to sell products that is open for acceptance or the grant, conveyance or implication of any license under any copyrights, patents or other industrial or intellectual property rights.

Export control — This document as well as the item(s) described herein may be subject to export control regulations. Export might require a prior authorization from competent authorities.

Non-automotive qualified products — Unless this data sheet expressly states that this specific Nexperia product is automotive qualified, the product is not suitable for automotive use. It is neither qualified nor tested in accordance with automotive testing or application requirements. Nexperia accepts no liability for inclusion and/or use of non-automotive qualified products in automotive equipment or applications.

In the event that customer uses the product for design-in and use in automotive applications to automotive specifications and standards, customer (a) shall use the product without Nexperia's warranty of the product for such automotive applications, use and specifications, and (b) whenever customer uses the product for automotive applications beyond

Nexperia's specifications such use shall be solely at customer's own risk, and (c) customer fully indemnifies Nexperia for any liability, damages or failed product claims resulting from customer design and use of the product for automotive applications beyond Nexperia's standard warranty and Nexperia's product specifications.

Translations — A non-English (translated) version of a document is for reference only. The English version shall prevail in case of any discrepancy between the translated and English versions.

16.4 Trademarks

Notice: All referenced brands, product names, service names and trademarks are the property of their respective owners.

17. Contact information

For more information, please visit: <http://www.nexperia.com>

For sales office addresses, please send an email to: salesaddresses@nexperia.com

18. Contents

1	General description	1
2	Features and benefits	1
3	Ordering information	2
4	Marking	2
5	Functional diagram	2
6	Pinning information	3
6.1	Pinning	3
6.2	Pin description	3
7	Functional description	3
8	Limiting values	4
9	Recommended operating conditions	4
10	Static characteristics	4
10.1	Test circuits	5
10.2	ON resistance	6
10.3	ON resistance test circuit and graphs	6
11	Dynamic characteristics	8
12	Waveforms	9
12.1	Additional dynamic characteristics	11
12.2	Test circuits	11
13	Package outline	12
14	Abbreviations	14
15	Revision history	14
16	Legal information	15
16.1	Data sheet status	15
16.2	Definitions	15
16.3	Disclaimers	15
16.4	Trademarks	16
17	Contact information	16
18	Contents	17



Стандарт Электрон Связь

Мы молодая и активно развивающаяся компания в области поставок электронных компонентов. Мы поставляем электронные компоненты отечественного и импортного производства напрямую от производителей и с крупнейших складов мира.

Благодаря сотрудничеству с мировыми поставщиками мы осуществляем комплексные и плановые поставки широчайшего спектра электронных компонентов.

Собственная эффективная логистика и склад в обеспечивает надежную поставку продукции в точно указанные сроки по всей России.

Мы осуществляем техническую поддержку нашим клиентам и предпродажную проверку качества продукции. На все поставляемые продукты мы предоставляем гарантию .

Осуществляем поставки продукции под контролем ВП МО РФ на предприятия военно-промышленного комплекса России , а также работаем в рамках 275 ФЗ с открытием отдельных счетов в уполномоченном банке. Система менеджмента качества компании соответствует требованиям ГОСТ ISO 9001.

Минимальные сроки поставки, гибкие цены, неограниченный ассортимент и индивидуальный подход к клиентам являются основой для выстраивания долгосрочного и эффективного сотрудничества с предприятиями радиоэлектронной промышленности, предприятиями ВПК и научно-исследовательскими институтами России.

С нами вы становитесь еще успешнее!

Наши контакты:

Телефон: +7 812 627 14 35

Электронная почта: sales@st-electron.ru

Адрес: 198099, Санкт-Петербург,
Промышленная ул, дом № 19, литера Н,
помещение 100-Н Офис 331