



# 80x80x25 mm

San Ace 80 9GA type Low Power Consumption Fan

## General Specifications

- Material ..... Frame: Plastic (Flammability: UL 94V-0), Impeller: Plastic (Flammability: UL 94V-0)
- Expected life ..... See the table below. (L10 life: 90% survival rate for continuous operation in free air at 60°C, rated voltage)
- Motor protection function ..... Locked rotor burnout protection, Reverse polarity protection  
For details, please refer to p. 547.
- Dielectric strength ..... 50/60 Hz, 500 VAC, for 1 minute (between lead wire conductors and frame)
- Insulation resistance ..... 10 MΩ or more with a 500 VDC megger (between lead wire conductors and frame)
- Sound pressure level (SPL) ..... At 1 m away from the air inlet
- Storage temperature ..... -30 to +70°C (Non-condensing)
- Lead wire ..... ⊕Red ⊖Black (Sensor) Yellow (Control) Brown
- Mass ..... 110 g

## Specifications

The models listed below **have ribs and pulse sensors with PWM control function.** For models without ribs, append "1" to the end of model numbers.

Model no.	Rated voltage [V]	Operating voltage range [V]	PWM duty cycle* [%]	Rated current [A]	Rated input [W]	Rated speed [min <sup>-1</sup> ]	Max. airflow [m <sup>3</sup> /min] [CFM]	Max. static pressure [Pa] [inchH <sub>2</sub> O]	SPL [dB (A)]	Operating temperature [°C]	Expected life [h]
9GA0812P4J001	12	10.8 to 13.2	100	0.6	7.2	7400	2.07 73.0	177.6 0.7	48	-20 to +70	40000/60°C (70000/40°C)
			25	0.08	0.96	2500	0.69 24.3	20.2 0.08	21		
9GA0812P4G001			100	0.48	5.76	6800	1.91 67.4	150 0.6	45		
			25	0.06	0.72	1500	0.42 14.8	7.2 0.02	17		
9GA0812P4H001			100	0.22	2.64	5200	1.46 51.5	87.7 0.35	37		
			25	0.06	0.72	1600	0.44 15.5	8.3 0.03	17		
9GA0824P4J001	24	21.6 to 26.4	100	0.28	6.72	7400	2.07 73.0	177.6 0.7	48		
			25	0.06	1.44	2800	0.78 27.5	25.4 0.1	23		
9GA0824P4G001			100	0.21	5.04	6800	1.91 67.4	150 0.6	45		
			25	0.04	0.96	2100	0.58 20.4	14.3 0.05	19		
9GA0824P4H001			100	0.1	2.4	5200	1.46 51.5	87.7 0.35	37		
			25	0.02	0.48	1500	0.42 14.8	7.2 0.02	17		

\* PWM frequency: 25 kHz. Fan does not rotate when PWM duty cycle is 0%.

The following sensor and control options are available for selection.

Available for all models. **Without sensor** **Pulse sensor**

Differs according to the model. Refer to the table on pp. 571 to 572. **Lock sensor**

## Airflow - Static Pressure Characteristics / PWM Duty - Speed Characteristics Example

**9GA0812P4J001** With pulse sensor with PWM control function

PWM duty cycle

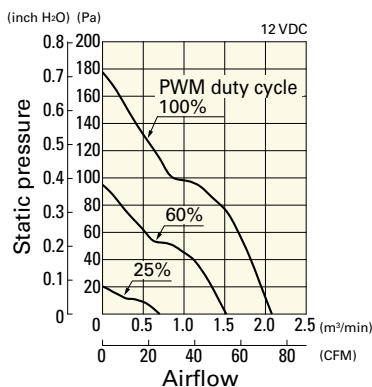

Operating voltage range

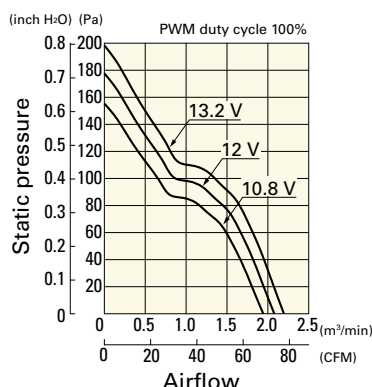

PWM duty - Speed characteristics example

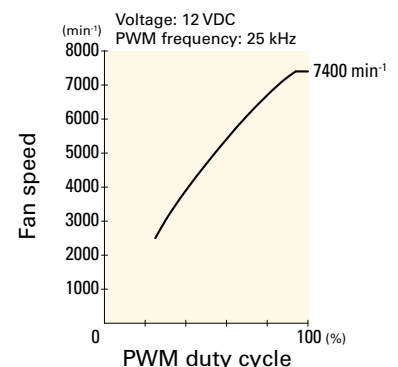

# Airflow - Static Pressure Characteristics / PWM Duty - Speed Characteristics Example

DC

DC Fan 80 mm sq.

## 9GA0812P4G001 With pulse sensor with PWM control function

PWM duty cycle



Operating voltage range

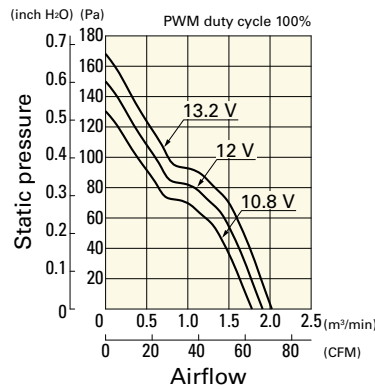

PWM duty - Speed characteristics example



## 9GA0812P4H001 With pulse sensor with PWM control function

PWM duty cycle

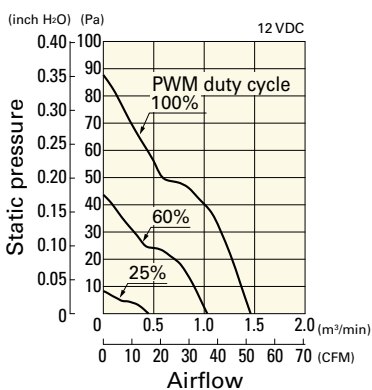

Operating voltage range

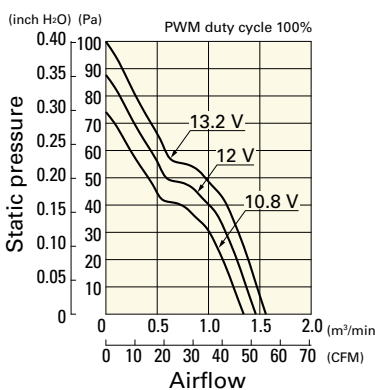

PWM duty - Speed characteristics example

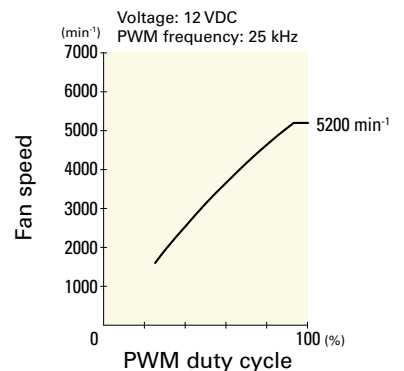

## 9GA0824P4J001 With pulse sensor with PWM control function

PWM duty cycle

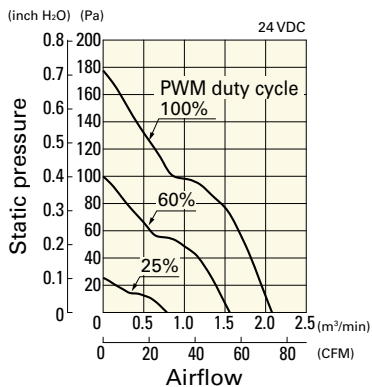

Operating voltage range

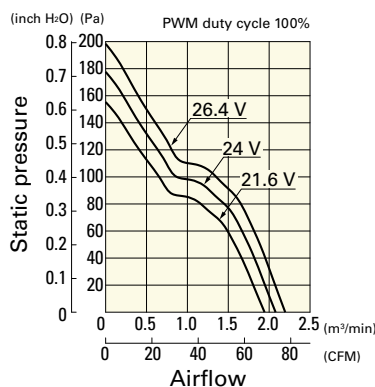

PWM duty - Speed characteristics example

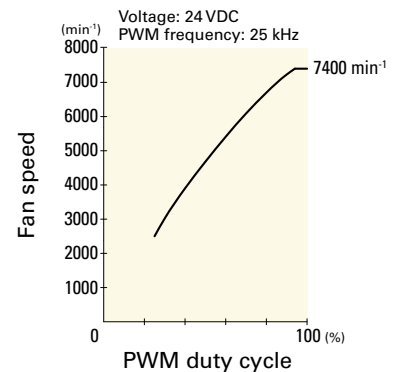

## 9GA0824P4G001 With pulse sensor with PWM control function

PWM duty cycle

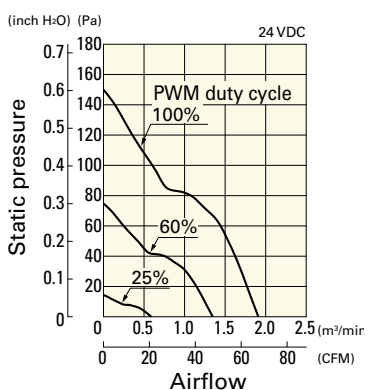

Operating voltage range

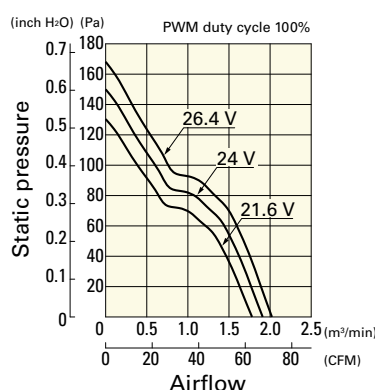

PWM duty - Speed characteristics example

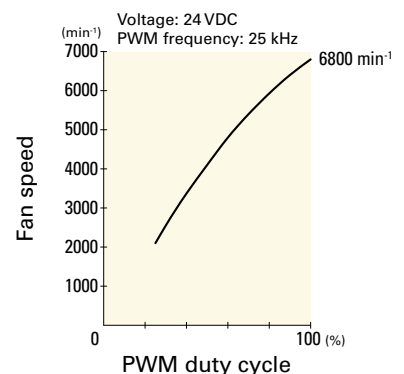

## Airflow - Static Pressure Characteristics / PWM Duty - Speed Characteristics Example

**9GA0824P4H001** With pulse sensor with PWM control function

PWM duty cycle



Operating voltage range

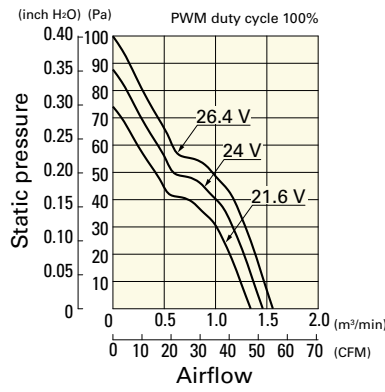

PWM duty - Speed characteristics example



## Dimensions (unit: mm) (With ribs)

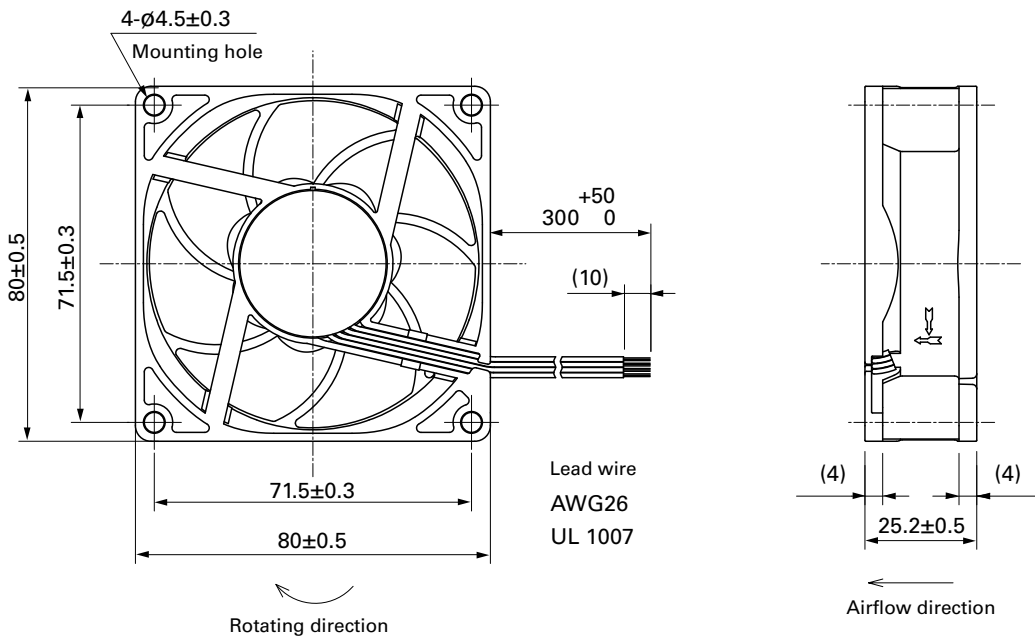

## Reference Dimensions of Mounting Holes and Vent Opening (unit: mm)



## Options

---

### Finger guards

page: p. 532

Model no.: 109-049E, 109-049H, 109-049C

### Resin finger guards

page: p. 539

Model no.: 109-1002G

### Resin filter kits

page: p. 540

Model no.: 109-1002F13 (13PPI), 109-1002F20 (20PPI),  
109-1002F30 (30PPI), 109-1002F40 (40PPI)



**Стандарт  
Электрон  
Связь**

Мы молодая и активно развивающаяся компания в области поставок электронных компонентов. Мы поставляем электронные компоненты отечественного и импортного производства напрямую от производителей и с крупнейших складов мира.

Благодаря сотрудничеству с мировыми поставщиками мы осуществляем комплексные и плановые поставки широчайшего спектра электронных компонентов.

Собственная эффективная логистика и склад в обеспечивает надежную поставку продукции в точно указанные сроки по всей России.

Мы осуществляем техническую поддержку нашим клиентам и предпродажную проверку качества продукции. На все поставляемые продукты мы предоставляем гарантию .

Осуществляем поставки продукции под контролем ВП МО РФ на предприятия военно-промышленного комплекса России , а также работаем в рамках 275 ФЗ с открытием отдельных счетов в уполномоченном банке. Система менеджмента качества компании соответствует требованиям ГОСТ ISO 9001.

Минимальные сроки поставки, гибкие цены, неограниченный ассортимент и индивидуальный подход к клиентам являются основой для выстраивания долгосрочного и эффективного сотрудничества с предприятиями радиоэлектронной промышленности, предприятиями ВПК и научно-исследовательскими институтами России.

С нами вы становитесь еще успешнее!

**Наши контакты:**

**Телефон:** +7 812 627 14 35

**Электронная почта:** [sales@st-electron.ru](mailto:sales@st-electron.ru)

**Адрес:** 198099, Санкт-Петербург,  
Промышленная ул, дом № 19, литера Н,  
помещение 100-Н Офис 331