

## 4 x 45 W power amplifier with full I<sup>2</sup>C diagnostics, high efficiency, SSR and low voltage operation

Datasheet - production data

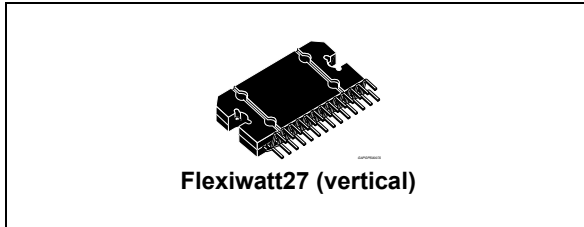

- ESD protection
- Very robust against misconnections
- Improved SVR suppression during battery transients
- Capable to operate down to 6 V (e.g. "Start-stop")
- SSR (speaker safety routine)

### Features

- Multipower BCD technology
- MOSFET output power stage
- DMOS power output
- High efficiency (class SB)
- High output power capability 4x25 W/4 Ω @ 14.4 V, 1 kHz, 10% THD, 4 x 45 W max power
- 2 Ω driving capability (64 W max power)
- Full I<sup>2</sup>C bus driving:
  - Standby
  - Independent front/rear soft play/mute
  - Selectable gain 30 dB /16 dB (for low noise line output function)
  - High efficiency enable/disable
  - I<sup>2</sup>C bus digital diagnostics (including DC and AC load detection)
- Flexible fault detection through integrated diagnostic
- DC offset detection
- Four independent short circuit protection
- Clipping detector pin with selectable threshold (2 %/10 %)
- Standby/mute pin
- Linear thermal shutdown with multiple thermal warning

### Description

The TDA75613LV is a new quad bridge car radio amplifier, designed in BCD technology, in order to include a wide range of innovative features in a very compact and flexible device.

The TDA75613LV is equipped with the most complete diagnostics array that communicates the status of each speaker through the I<sup>2</sup>C bus.

The dissipated output power under average listening condition is significantly reduced when compared to the conventional class AB solutions, thanks to the patented 'class SB' efficiency concept. TDA75613LV has been designed to be very robust against several kinds of misconnections.

The TDA75613LV is equipped with the SSR (speaker safety routine), a procedure able to check the offset at the speakers and automatically shut down the power amplifier in case of dangerous DC voltage.

It is moreover compliant to the most recent OEM specifications for low voltage operation (so called 'start-stop' battery profile during engine stop), helping car manufacturers to reduce the overall emissions and thus contributing to environment protection.

Table 1. Device summary

Order code	Package	Packing
TDA75613LV	Flexiwatt27 (vertical)	Tube

# Contents

- 1      Block diagram and application circuits ..... 6**
- 2      Pins description ..... 7**
- 3      Electrical specifications ..... 9**
  - 3.1 Absolute maximum ratings ..... 9
  - 3.2 Thermal data ..... 9
  - 3.3 Electrical characteristics ..... 10
  - 3.4 Electrical characteristic curves ..... 14
- 4      Diagnostics functional description ..... 17**
  - 4.1 Turn-on diagnostic ..... 17
  - 4.2 Permanent diagnostics ..... 19
  - 4.3 AC diagnostic ..... 20
- 5      Output DC offset detection ..... 22**
  - 5.1 Offset detection and mute at start-up, SSR (Speaker Safety Routine) .. 22
  - 5.2 Offset detection in normal operation ..... 23
- 6      Multiple faults ..... 24**
  - 6.1 Faults availability ..... 24
- 7      Thermal protection ..... 25**
  - 7.1 Fast muting ..... 25
- 8      Battery transitions management ..... 26**
  - 8.1 Low voltage operation (“start stop”) ..... 26
  - 8.2 Advanced battery management ..... 27
- 9      Application suggestion ..... 28**
  - 9.1 High efficiency introduction ..... 28
- 10     I<sup>2</sup>C bus ..... 29**
  - 10.1 I<sup>2</sup>C programming/reading sequences ..... 29

---

10.2	Address selection and I <sup>2</sup> C disable .....	29
10.3	I <sup>2</sup> C bus interface .....	29
10.3.1	Data validity .....	29
10.3.2	Start and stop conditions .....	30
10.3.3	Byte format .....	30
10.3.4	Acknowledge .....	30
<b>11</b>	<b>Software specifications .....</b>	<b>31</b>
<b>12</b>	<b>Examples of bytes sequence .....</b>	<b>36</b>
<b>13</b>	<b>Package information .....</b>	<b>37</b>
<b>14</b>	<b>Revision history .....</b>	<b>38</b>

## List of tables

Table 1.	Device summary . . . . .	1
Table 2.	Pins list description . . . . .	8
Table 3.	Absolute maximum ratings . . . . .	9
Table 4.	Thermal data . . . . .	9
Table 5.	Electrical characteristics . . . . .	10
Table 6.	Double fault table for turn on diagnostic . . . . .	24
Table 7.	IB1 . . . . .	31
Table 8.	IB2 . . . . .	32
Table 9.	DB1 . . . . .	32
Table 10.	DB2 . . . . .	33
Table 11.	DB3 . . . . .	34
Table 12.	DB4 . . . . .	35
Table 13.	Document revision history . . . . .	38

## List of figures

Figure 1.	Block diagram . . . . .	6
Figure 2.	Application circuit . . . . .	6
Figure 3.	Pins connection diagram (top of view) . . . . .	7
Figure 4.	Quiescent current vs. supply voltage . . . . .	14
Figure 5.	Output power vs. supply voltage (4 $\Omega$ ) . . . . .	14
Figure 6.	Distortion vs. output power (4 $\Omega$ , STD) . . . . .	14
Figure 7.	Distortion vs. output power (4 $\Omega$ , HI-EFF) . . . . .	14
Figure 8.	Distortion vs. output power (2 $\Omega$ , STD) . . . . .	14
Figure 9.	Distortion vs. output power (2 $\Omega$ , HI-EFF) . . . . .	14
Figure 10.	Distortion vs. frequency (2 $\Omega$ , 8W, STD) . . . . .	15
Figure 11.	Distortion vs. output power $V_s = 6$ V (4 $\Omega$ , STD) . . . . .	15
Figure 12.	Distortion vs. frequency (4 $\Omega$ , 4W, STD) . . . . .	15
Figure 13.	Crosstalk vs. frequency . . . . .	15
Figure 14.	Supply voltage rejection vs. frequency . . . . .	15
Figure 15.	Power dissipation vs. average $P_o$ (audio program simulation, 2 $\Omega$ ) . . . . .	15
Figure 16.	Power dissipation vs. average $P_o$ (audio program simulation, 4 $\Omega$ ) . . . . .	16
Figure 17.	Total power dissipation & efficiency vs. output power (4 $\Omega$ , HI-EFF, Sine) . . . . .	16
Figure 18.	Total power dissipation & efficiency vs. output power (4 $\Omega$ , STD, Sine) . . . . .	16
Figure 19.	ITU R-ARM frequency response, weighting filter for transient pop. . . . .	16
Figure 20.	Turn-on diagnostic: working principle . . . . .	17
Figure 21.	SVR and output behavior (Case 1: without turn-on diagnostic) . . . . .	17
Figure 22.	SVR and output pin behavior (Case 2: with turn-on diagnostic) . . . . .	18
Figure 23.	Short circuit detection thresholds . . . . .	18
Figure 24.	Load detection thresholds - high gain setting . . . . .	18
Figure 25.	Load detection threshold - low gain setting . . . . .	18
Figure 26.	Restart timing without diagnostic enable (permanent) - Each 1 mS time, a sampling of the fault is done . . . . .	19
Figure 27.	Restart timing with diagnostic enable (permanent) . . . . .	19
Figure 28.	Current detection high: load impedance $ Z $ vs. output peak voltage . . . . .	21
Figure 29.	Current detection low: load impedance $ Z $ vs. output peak voltage . . . . .	21
Figure 30.	Power on sequence with a detected offset lower than 2 V . . . . .	22
Figure 31.	Power on sequence with a detected offset higher than 2 V . . . . .	23
Figure 32.	Thermal foldback diagram . . . . .	25
Figure 33.	Worst case battery cranking curve sample 1 . . . . .	26
Figure 34.	Worst case battery cranking curve sample 2 . . . . .	26
Figure 35.	Upwards fast battery transitions diagram . . . . .	27
Figure 36.	High efficiency - basic structure . . . . .	28
Figure 37.	Data validity on the I <sup>2</sup> C bus . . . . .	30
Figure 38.	Timing diagram on the I <sup>2</sup> C bus . . . . .	30
Figure 39.	Acknowledge on the I <sup>2</sup> C bus . . . . .	30
Figure 40.	Flexiwatt27 (vertical) mechanical data and package dimensions . . . . .	37

# 1 Block diagram and application circuits

Figure 1. Block diagram

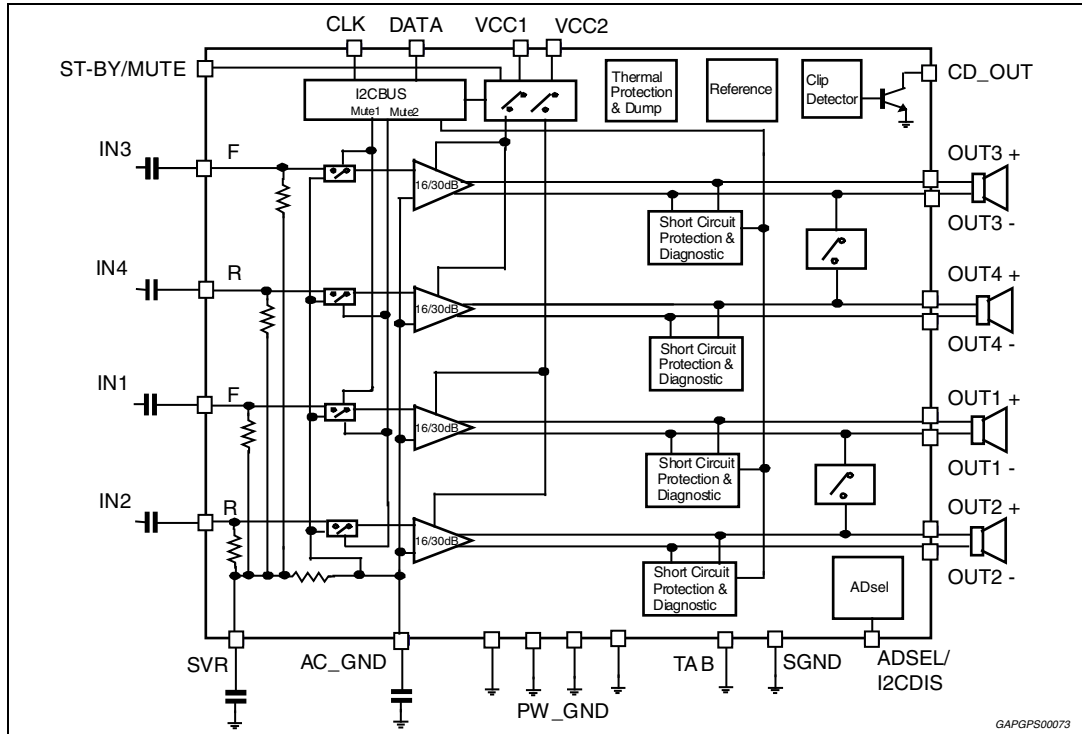
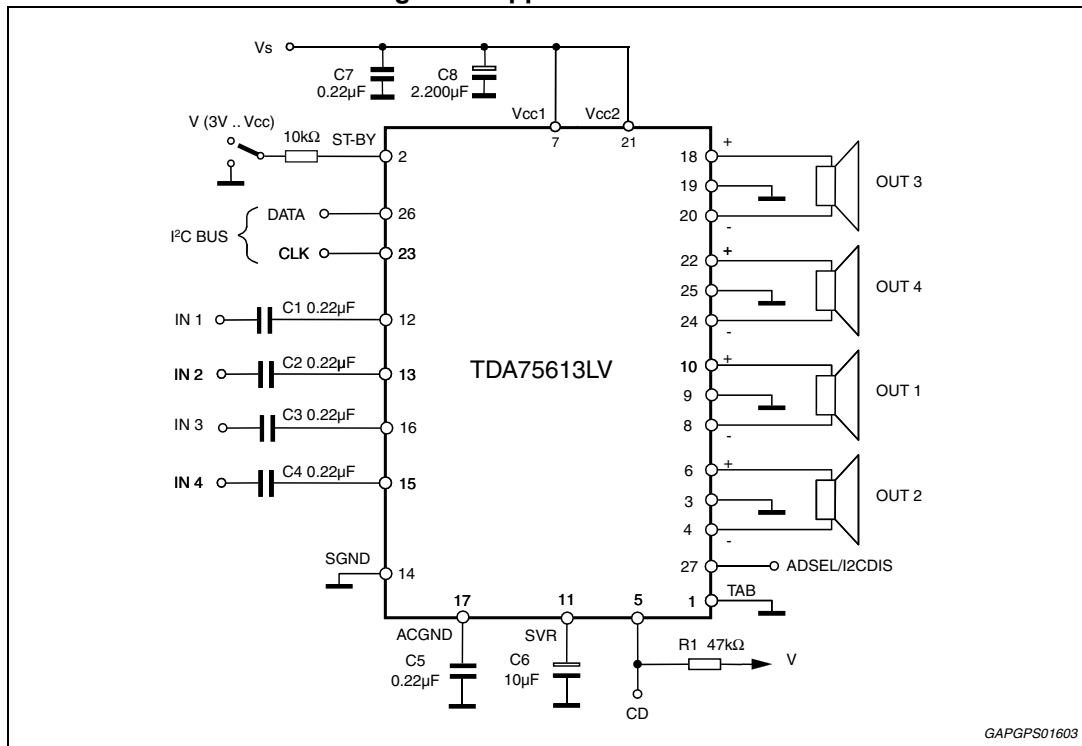

Figure 2. Application circuit



## 2 Pins description

For channel name reference: CH1 = LF, CH2 = LR, CH3 = RF and CH4 = RR.

**Figure 3. Pins connection diagram (top of view)**

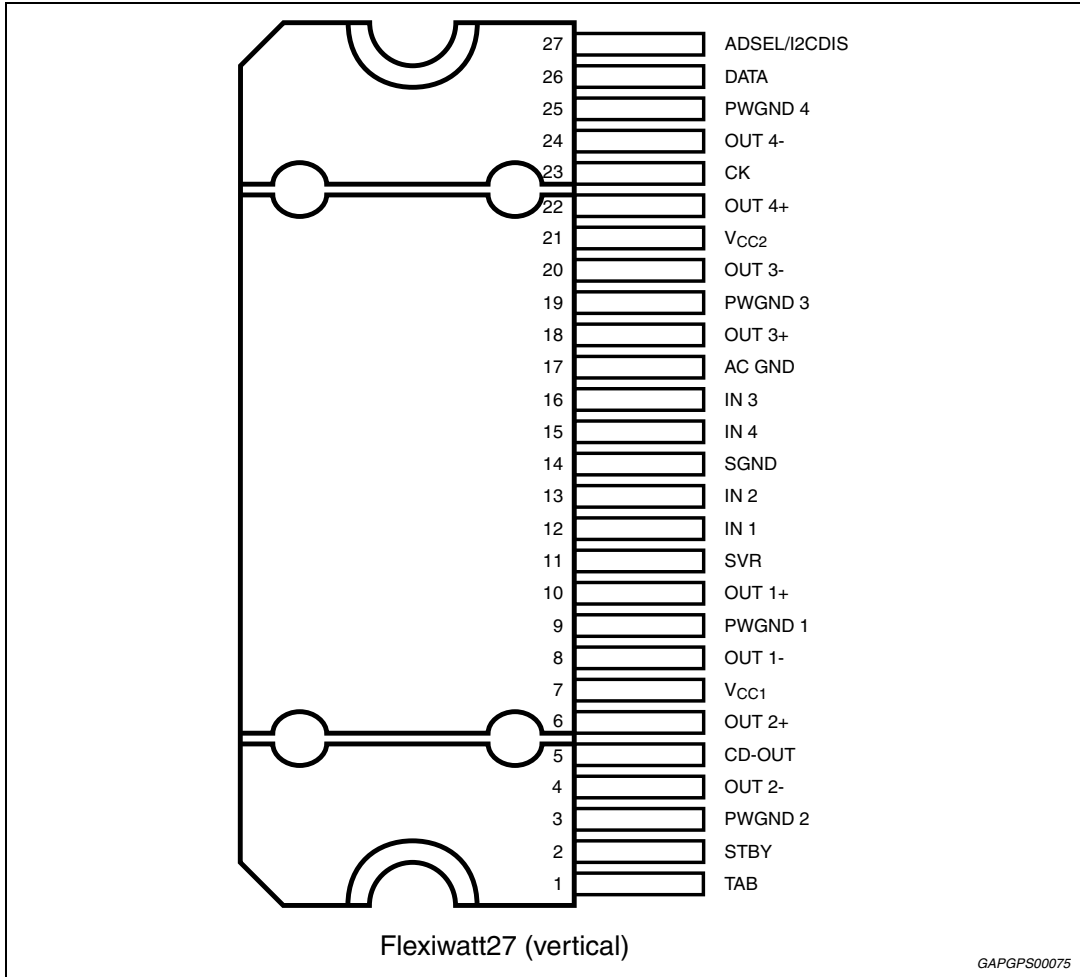

Table 2. Pins list description

Pin #	Pin name	Function
1	TAB	-
2	STBY	Standby pin
3	PWGND2	Channel 2 output power ground
4	OUT2-	Channel 2, - output
5	CD	Clip detector output pin
6	OUT2+	Channel 2, + output
7	VCC1	Supply voltage pin1
8	OUT1-	Channel 1, - output
9	PWGND1	Channel 1 output power ground
10	OUT1+	Channel 1, + output
11	SVR	SVR pin
12	IN1	Input pin, channel 1
13	IN2	Input pin, channel 2
14	SGND	Signal ground pin
15	IN4	Input pin, channel 4
16	IN3	Input pin, channel 3
17	AC GND	AC ground
18	OUT3+	Channel 3, + output
19	PWGND3	Channel 3 output power ground
20	OUT3-	Channel 3, - output
21	VCC2	Supply voltage pin2
22	OUT4+	Channel 4, + output
23	CK	I <sup>2</sup> C bus clock/HE selector
24	OUT4-	Channel 4, - output
25	PWGND4	Channel 4 output power ground
26	DATA	I <sup>2</sup> C bus data pin/gain selector
27	ADSEL/I2CDIS	Address selector pin/ I <sup>2</sup> C bus disable (legacy select)



## 3 Electrical specifications

### 3.1 Absolute maximum ratings

Table 3. Absolute maximum ratings

Symbol	Parameter	Value	Unit
$V_{op}$	Operating supply voltage <sup>(1)</sup>	18	V
$V_S$	DC supply voltage	28	V
$V_{peak}$	Peak supply voltage (for $t_{max} = 50$ ms)	50	V
GNDmax	Ground pins voltage	-0.3 to 0.3	V
$V_{CK}, V_{DATA}$	CK and DATA pin voltage	-0.3 to 6	V
$V_{cd}$	Clip detector voltage	-0.3 to 5.5	V
$V_{stby}$	STBY pin voltage	-0.3 to $V_{op}$	V
$I_O$	Output peak current (not repetitive $t_{max} = 100$ ms)	8	A
	Output peak current (repetitive $f > 10$ kHz)	6	
$P_{tot}$	Power dissipation $T_{case} = 70^\circ\text{C}$	85	W
$T_{stg}, T_j$	Storage and junction temperature <sup>(2)</sup>	-55 to 150	$^\circ\text{C}$
$T_{amb}$	Operative temperature range	-40 to +105	$^\circ\text{C}$

1. For  $R_L = 2 \Omega$  the output current limit might be reached for  $V_{OP} > 16$  V; thus triggering self-protection.

2. A suitable dissipation system should be used to keep  $T_j$  inside the specified limits.

### 3.2 Thermal data

Table 4. Thermal data

Symbol	Parameter	Value	Unit
$R_{th\ j-case}$	Thermal resistance junction-to-case Max.	1	$^\circ\text{C}/\text{W}$

### 3.3 Electrical characteristics

Refer to the test circuit,  $V_S = 14.4\text{ V}$ ;  $R_L = 4\ \Omega$ ;  $f = 1\text{ kHz}$ ;  $G_V = 30\text{ dB}$ ;  $T_{\text{amb}} = 25\text{ }^\circ\text{C}$ ; unless otherwise specified.

**Table 5. Electrical characteristics**

Symbol	Parameter	Test condition	Min.	Typ.	Max.	Unit
<b>General characteristics</b>						
$V_S$	Supply voltage range	$R_L = 4\ \text{ohm}$	6	-	18	V
		$R_L = 2\ \text{ohm}$	6	-	16 <sup>(1)</sup>	
$I_d$	Total quiescent drain current	-	-	165	250	mA
$R_{IN}$	Input impedance	-	45	60	70	k $\Omega$
$V_{AM}$	Min. supply mute threshold	IB1(D7) = 1	7	-	8	V
		IB1(D7) = 0 (default) <sup>(2)</sup>	5	-	6	
$V_{OS}$	Offset voltage	Mute & play	-100	0	100	mV
$V_{dth}$	Dump threshold	-	18.5	19.5	20.5	V
$I_{SB}$	Standby current	$V_{\text{standby}} = 0$	-	1	5	$\mu\text{A}$
SVR	Supply voltage rejection	$f = 100\text{ Hz to }10\text{ kHz}$ ; $V_r = 1\text{ Vpk}$ ; $R_g = 600\ \Omega$	55	60	-	dB
$T_{ON}$	Turn on timing (Mute play transition)	D2/D1 (IB1) 0 to 1	-	25	50	ms
$T_{OFF}$	Turn off timing (Play mute transition)	D2/D1 (IB1) 1 to 0	-	25	50	ms
$TH_{\text{WARN1}}$	Average junction temperature for TH warning 1	DB1 (D7) = 1	-	160	-	$^\circ\text{C}$
$TH_{\text{WARN2}}$	Average junction temperature for TH warning 2	DB4 (D7) = 1	-	145	-	
$TH_{\text{WARN3}}$	Average junction temperature for TH warning 3	DB4 (D6) = 1	-	125	-	
<b>Audio performances</b>						
$P_O$	Output power	Max. power <sup>(3)</sup> $V_S = 15.2\text{ V}$ , $R_L = 4\ \Omega$	-	45	-	W
		THD = 10 %, $R_L = 4\ \Omega$	23	25	-	W
		THD = 1 %, $R_L = 4\ \Omega$	-	22	-	W
		$R_L = 2\ \Omega$ ; THD 10 %	-	44	-	W
		$R_L = 2\ \Omega$ ; THD 1 %	-	33	-	W
		$R_L = 2\ \Omega$ ; Max. power <sup>(3)</sup> $V_S = 14.4\text{ V}$	-	64	-	W
		Max power@ $V_S = 6\text{ V}$ , $R_L = 4\ \Omega$	-	5	-	W

Table 5. Electrical characteristics (continued)

Symbol	Parameter	Test condition	Min.	Typ.	Max.	Unit
THD	Total harmonic distortion	$P_O = 1\text{ W to }10\text{ W}$ ; STD mode	-	0.015	0.1	%
		HE MODE; $P_O = 1.5\text{ W}$	-	0.05	0.1	%
		HE MODE; $P_O = 8\text{ W}$	-	0.1	0.5	%
		$P_O = 1\text{-}10\text{ W}$ , $f = 10\text{ kHz}$	-	0.15	0.5	%
		$G_V = 16\text{ dB}$ ; STD Mode $V_O = 0.1\text{ to }5\text{ VRMS}$	-	0.02	0.05	%
$C_T$	Cross talk	$f = 1\text{ kHz to }10\text{ kHz}$ , $R_g = 600\ \Omega$	50	65	-	dB
$G_{V1}$	Voltage gain 1	-	29	30	31	dB
$\Delta G_{V1}$	Voltage gain match 1	-	-1	-	1	dB
$G_{V2}$	Voltage gain 2	-	15	16	17	dB
$\Delta G_{V2}$	Voltage gain match 2	-	-1	-	1	dB
$E_{IN1}$	Output noise voltage 1	$R_g = 600\ \Omega$ 20 Hz to 22 kHz	-	65	80	$\mu\text{V}$
$E_{IN2}$	Output noise voltage 2	$R_g = 600\ \Omega$ ; $G_V = 16\text{ dB}$ 20 Hz to 22 kHz	-	20	30	$\mu\text{V}$
BW	Power bandwidth	-	100	-	-	kHz
CMRR	Input CMRR	$V_{CM} = 1\text{ Vpk-pk}$ ; $R_g = 0\ \Omega$	-	70	-	dB
$\Delta V_{OS}$	During mute ON/OFF output offset voltage	ITU R-ARM weighted (see <a href="#">Figure 18</a> )	-10	-	10	mV
	During standby ON/OFF output offset voltage		-10	-	10	mV
<b>Clip detector</b>						
$CD_{LK}$	Clip det. high leakage current	CD off / $V_{CD} = 6\text{ V}$	-	0	5	$\mu\text{A}$
$CD_{SAT}$	Clip det sat. voltage	CD on; $I_{CD} = 1\text{ mA}$	-	-	300	mV
$CD_{THD}$	Clip det THD level	D0 (IB1) = 1	5	10	15	%
		D0 (IB1) = 0	1	2	3	%
<b>Control pin characteristics</b>						
$V_{SBY}$	Standby/mute pin for standby	-	0	-	1.2	V
$V_{MU}$	Standby/mute pin for mute	-	2.9	-	3.5	V
$V_{OP}$	Standby/mute pin for operating	-	4.5	-	18	V
$I_{MU}$	Standby/mute pin current	$V_{st-by/mute} = 4.5\text{ V}$	-	1	5	$\mu\text{A}$
		$V_{st-by/mute} < 1.2\text{ V}$	-	0	5	$\mu\text{A}$
$A_{SB}$	Standby attenuation	-	90	110	-	dB
$A_M$	Mute attenuation	-	80	100	-	dB

**Table 5. Electrical characteristics (continued)**

Symbol	Parameter	Test condition	Min.	Typ.	Max.	Unit
<b>Turn on diagnostics 1 (Power amplifier mode)</b>						
Pgnd	Short to GND det. (below this limit, the Output is considered in short circuit to GND)	Power amplifier in standby	-	-	1.2	V
Pvs	Short to Vs det. (above this limit, the output is considered in short circuit to Vs)		Vs -1.2	-	-	V
Pnop	Normal operation thresholds. (Within these limits, the output is considered without faults).		1.8	-	Vs -1.8	V
Lsc	Shorted load det.		-	-	0.5	Ω
Lop	Open load det.		85	-	-	Ω
Lnop	Normal load det.		1.5	-	45	Ω
<b>Turn on diagnostics 2 (Line driver mode)</b>						
Pgnd	Short to GND det. (below this limit, the output is considered in short circuit to GND)	Power amplifier in standby	-	-	1.2	V
Pvs	Short to Vs det. (above this limit, the output is considered in short circuit to Vs)	-	Vs -1.2	-	-	V
Pnop	Normal operation thresholds. (Within these limits, the output is considered without faults).	-	1.8	-	Vs -1.8	V
Lsc	Shorted load det.	-	-	-	1.5	Ω
Lop	Open load det.	-	330	-	-	Ω
Lnop	Normal load det.	-	7	-	180	Ω
<b>Permanent diagnostics 2 (Power amplifier mode or line driver mode)</b>						
Pgnd	Short to GND det. (below this limit, the Output is considered in short circuit to GND)	Power amplifier in mute or play, one or more short circuits protection activated	-	-	1.2	V
Pvs	Short to Vs det. (above this limit, the output is considered in short circuit to Vs)		Vs -1.2	-	-	V
Pnop	Normal operation thresholds. (Within these limits, the output is considered without faults).		1.8	-	Vs -1.8	V
L <sub>SC</sub>	Shorted load det.	Power amplifier mode	-	-	0.5	Ω
		Line driver mode	-	-	1.5	Ω
V <sub>O</sub>	Offset detection	Power amplifier in play, AC input signals = 0	±1.5	±2	±2.5	V

Table 5. Electrical characteristics (continued)

Symbol	Parameter	Test condition	Min.	Typ.	Max.	Unit
$I_{NLH}$	Normal load current detection	$V_O < (V_S - 5)\mu\text{k}$ , IB2 (D7) = 0	500	-	-	mA
$I_{OLH}$	Open load current detection		-	-	250	mA
$I_{NLL}$	Normal load current detection	$V_O < (V_S - 5)\mu\text{k}$ , IB2 (D7) = 1	250	-	-	mA
$I_{OLL}$	Open load current detection		-	-	125	mA
<b>I<sup>2</sup>C bus interface</b>						
$S_{CL}$	Clock frequency	-	-	-	400	kHz
$V_{IL}$	Input low voltage	-	-	-	1.5	V
$V_{IH}$	Input high voltage	-	2.3	-	-	V

1. When  $V_S > 16$  V the output current limit is reached (triggering embedded internal protections).
2. In legacy mode only low threshold option is available.
3. Saturated square wave output.

### 3.4 Electrical characteristic curves

Figure 4. Quiescent current vs. supply voltage

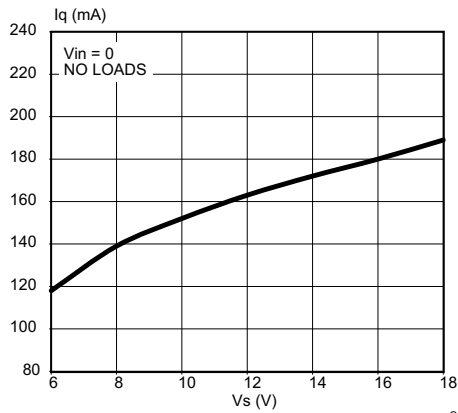

GAPGPS03161

Figure 5. Output power vs. supply voltage (4  $\Omega$ )

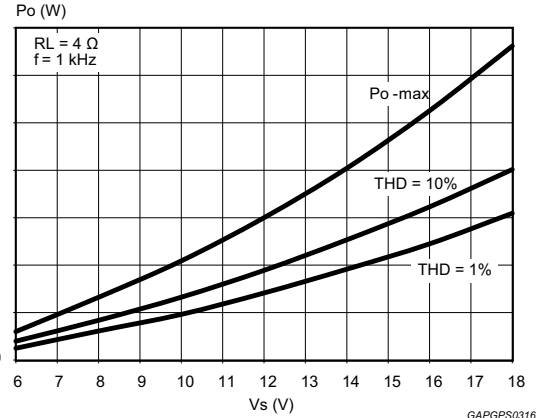

GAPGPS03162

Figure 6. Distortion vs. output power (4  $\Omega$ , STD)

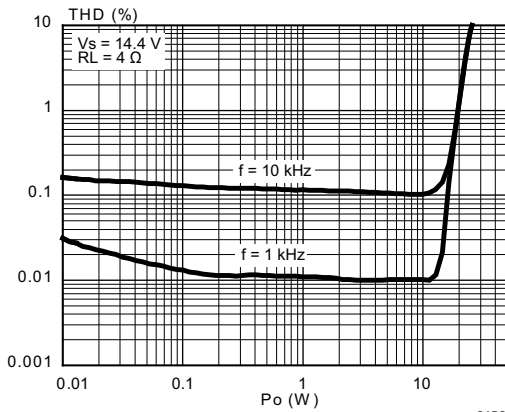

GAPGPS03163

Figure 7. Distortion vs. output power (4  $\Omega$ , HI-EFF)

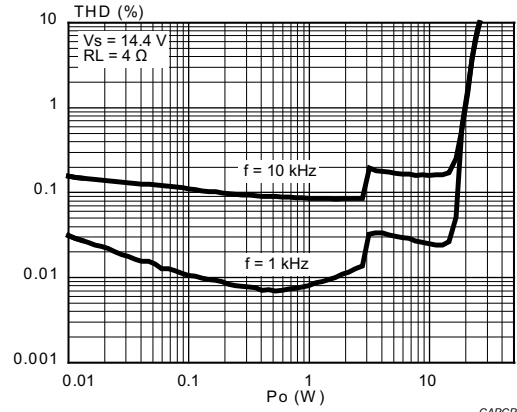

GAPGPS03164

Figure 8. Distortion vs. output power (2  $\Omega$ , STD)

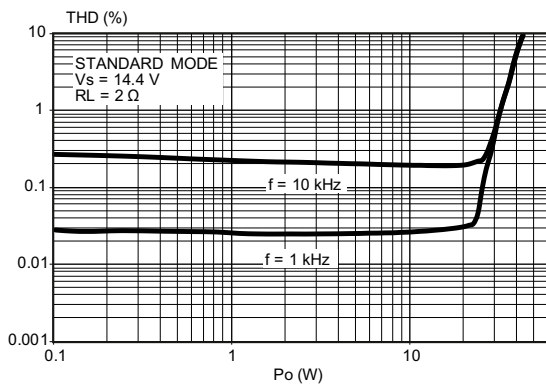

GAPGPS03213

Figure 9. Distortion vs. output power (2  $\Omega$ , HI-EFF)

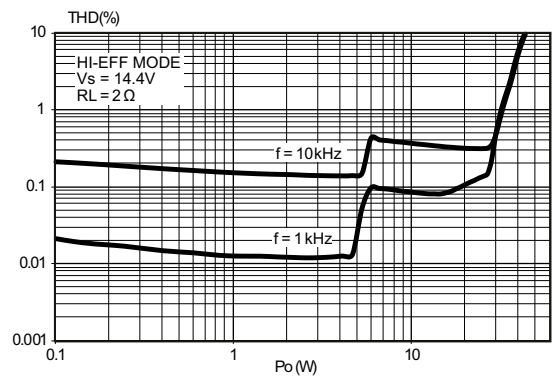

GAPGPS03214

**Figure 10. Distortion vs. frequency (2 Ω, 8W,STD)**

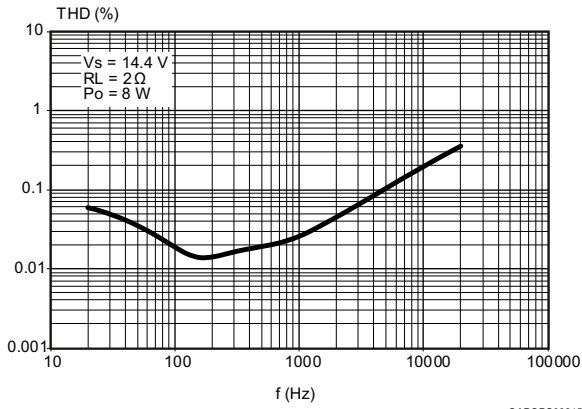

**Figure 11. Distortion vs. output power  $V_s = 6\text{ V}$  (4 Ω, STD)**

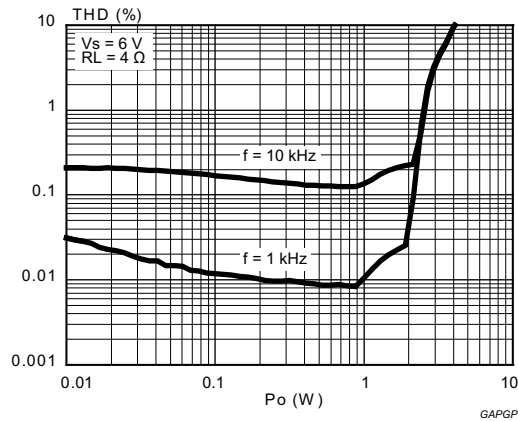

**Figure 12. Distortion vs. frequency (4 Ω, 4W, STD)**

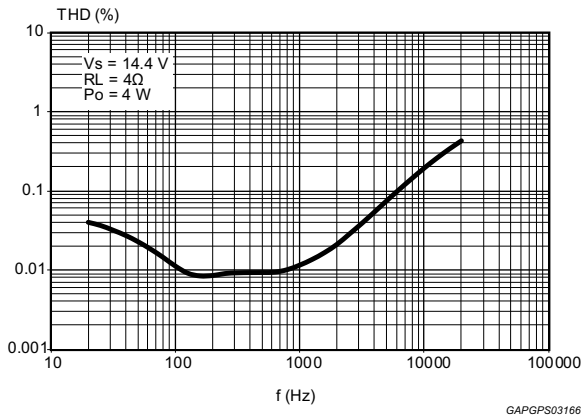

**Figure 13. Crosstalk vs. frequency**

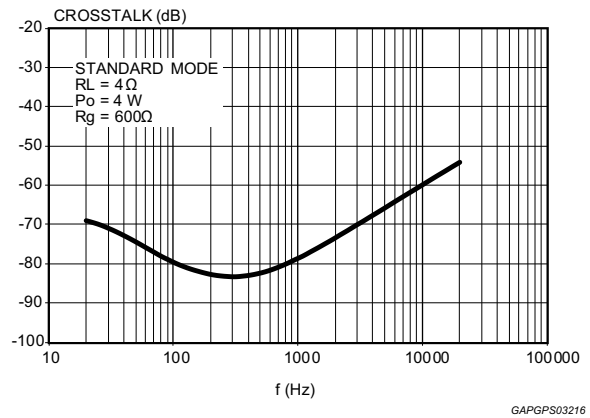

**Figure 14. Supply voltage rejection vs. frequency**

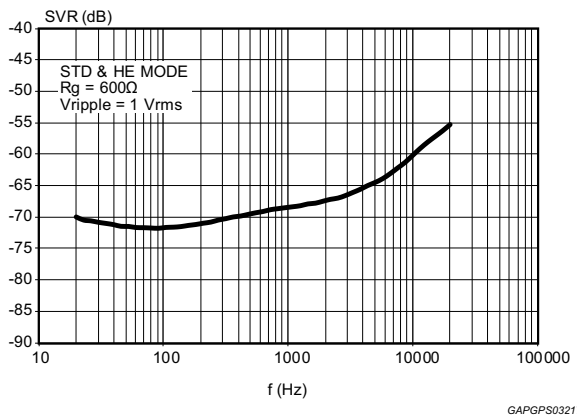

**Figure 15. Power dissipation vs. average  $P_o$  (audio program simulation, 2 Ω)**

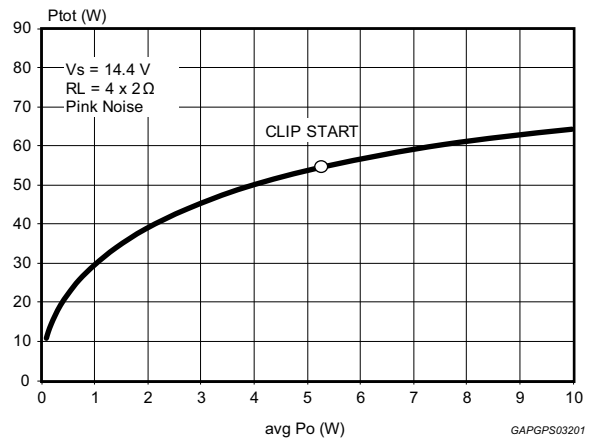

**Figure 16. Power dissipation vs. average Po (audio program simulation, 4 Ω)**

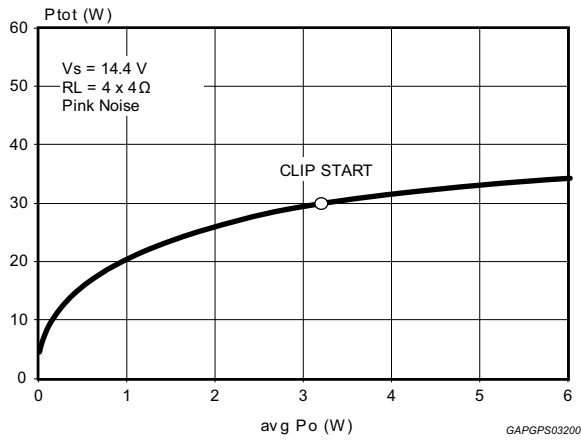

**Figure 17. Total power dissipation & efficiency vs. output power (4 Ω, HI-EFF, Sine)**

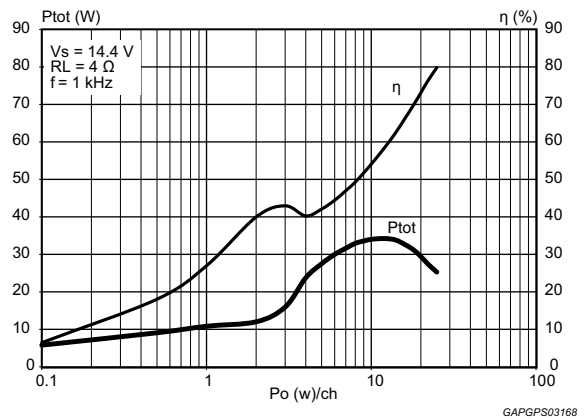

**Figure 18. Total power dissipation & efficiency vs. output power (4 Ω, STD, Sine)**

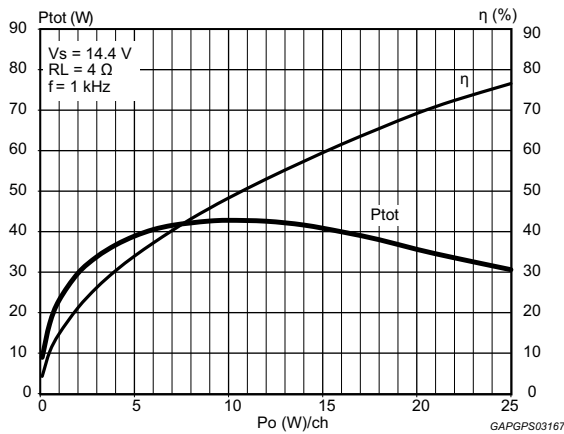

**Figure 19. ITU R-ARM frequency response, weighting filter for transient pop**

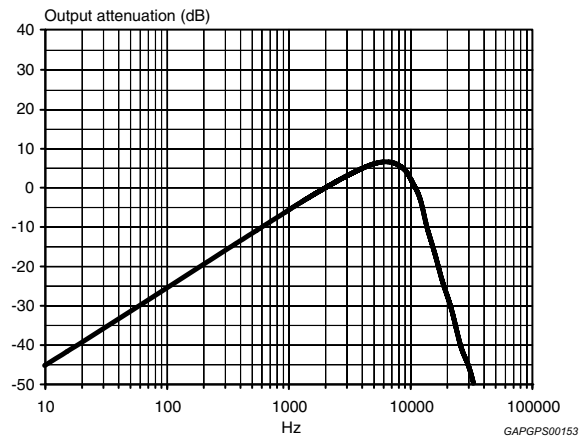



## 4 Diagnostics functional description

### 4.1 Turn-on diagnostic

It is recommended to activate this function at the turn-on (standby out) through an I<sup>2</sup>C bus request. Detectable output faults are:

- Short to GND
- Short to  $V_s$
- Short across the speaker
- Open speaker

To verify if any of the above misconnections are in place, a subsonic (inaudible) current pulse (Figure 20) is internally generated, sent through the speaker(s) and sunk back. The Turn On diagnostic status is internally stored until a successive diagnostic pulse is requested (after a I<sup>2</sup>C reading).

If the "standby out" and "diag. enable" commands are both given through a single programming step, the pulse takes place first (during the pulse the power stage stays 'off', showing high impedance at the outputs).

Afterwards, when the Amplifier is biased, the PERMANENT diagnostic takes place. The previous turn-on state is kept until a short appears at the outputs.

Figure 20. Turn-on diagnostic: working principle

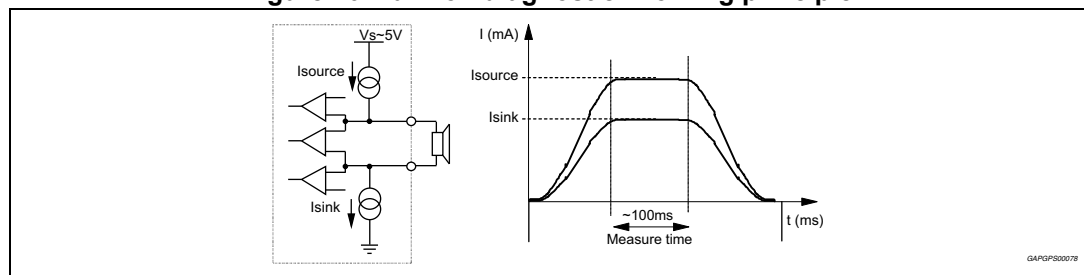

Figure 21 and 22 show SVR and OUTPUT waveforms at the turn-on (standby out) with and without turn-on diagnostic.

Figure 21. SVR and output behavior (Case 1: without turn-on diagnostic)

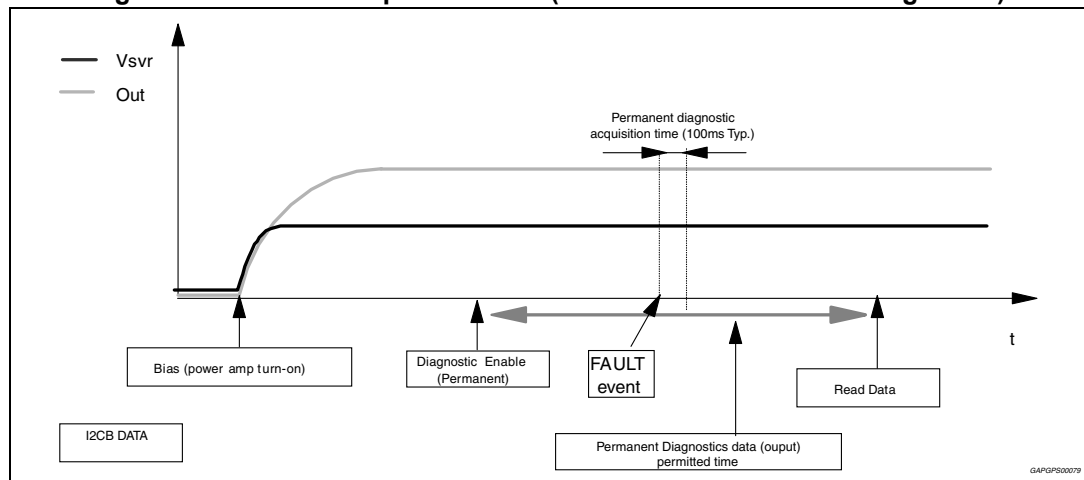
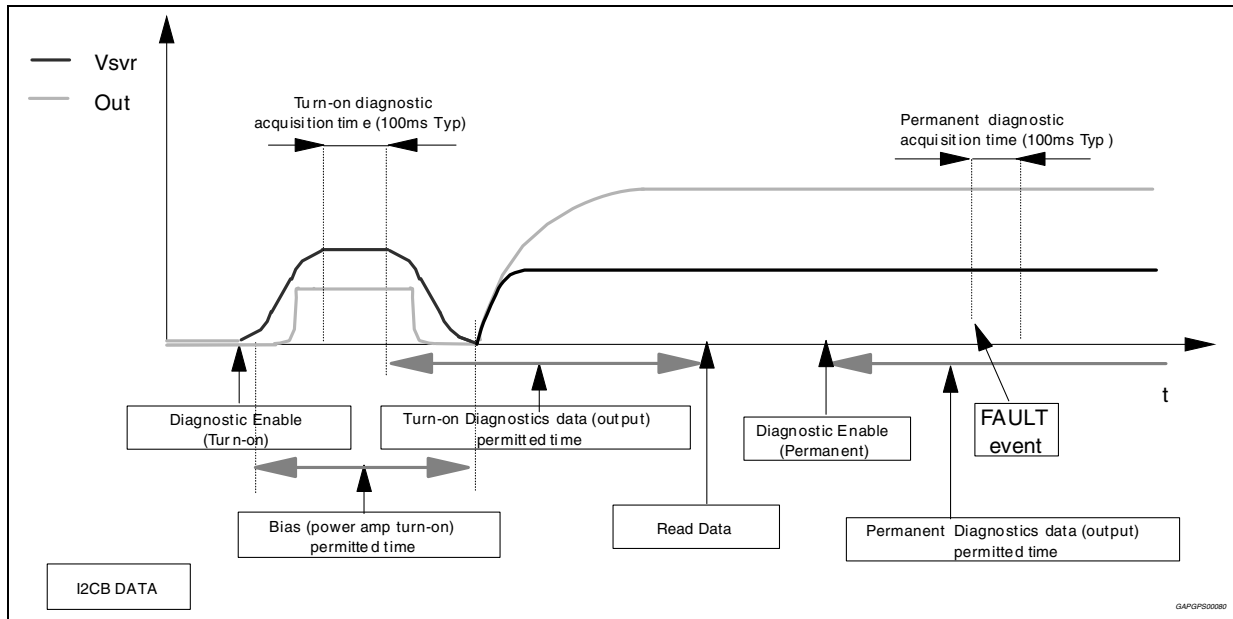
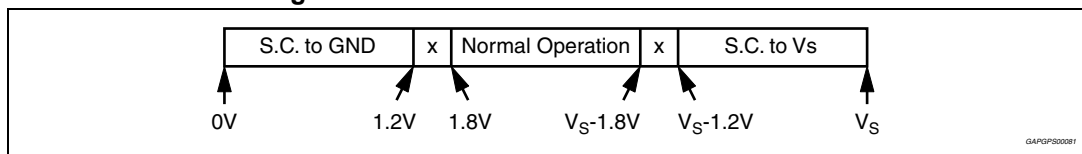

Figure 22. SVR and output pin behavior (Case 2: with turn-on diagnostic)



The information related to the outputs status is read and memorized at the end of the current pulse plateau. The acquisition time is 100 ms (typ.). No audible noise is generated in the process. As for SHORT TO GND / Vs the fault-detection thresholds remain unchanged from 30 dB to 16 dB gain setting. They are as follows:

Figure 23. Short circuit detection thresholds



Concerning SHORT ACROSS THE SPEAKER / OPEN SPEAKER, the threshold varies from 30 dB to 16 dB gain setting, since different loads are expected (either normal speaker's impedance or high impedance). The values in case of 30 dB gain are as follows:

Figure 24. Load detection thresholds - high gain setting

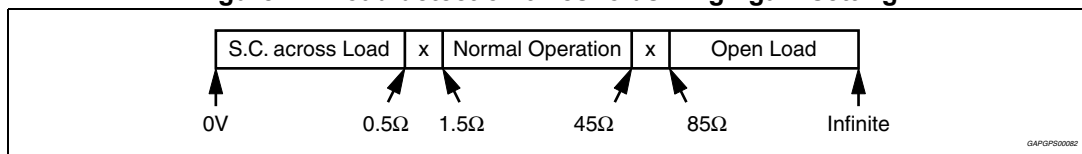

If the Line-Driver mode ( $G_V = 16$  dB and Line Driver Mode diagnostic = 1) is selected, the same thresholds will change as follows:

Figure 25. Load detection threshold - low gain setting

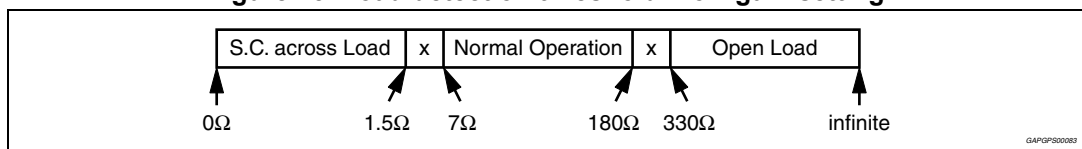

## 4.2 Permanent diagnostics

Detectable conventional faults are:

- Short to GND
- Short to Vs
- Short across the speaker

The following additional feature is provided:

- Output offset detection (see [Section 5](#))

The TDA75613LV has 2 operating status:

1. **RESTART mode.** The diagnostic is not enabled. Each audio channel operates independently of each other. If any of the a.m. faults occurs, only the channel(s) interested is shut down. A check of the output status is made every 1 ms ([Figure 26](#)). Restart takes place when the overload is removed.
2. **DIAGNOSTIC mode.** It is enabled via I<sup>2</sup>C bus and it self activates if an output overload (such as to cause the intervention of the short-circuit protection) occurs to the speakers outputs. Once activated, the diagnostics procedure develops as follows ([Figure 27](#)):
  - To avoid momentary re-circulation spikes from giving erroneous diagnostics, a check of the output status is made after 1ms: if normal situation (no overloads) is detected, the diagnostic is not performed and the channel returns active.
  - Instead, if an overload is detected during the check after 1 ms, then a diagnostic cycle having a duration of about 100 ms is started.
  - After a diagnostic cycle, the audio channel interested by the fault is switched to RESTART mode. The relevant data are stored inside the device and can be read by the microprocessor. When one cycle has terminated, the next one is activated by an I<sup>2</sup>C reading. This is to ensure continuous diagnostics throughout the car-radio operating time.
  - To check the status of the device a sampling system is needed. The timing is chosen at microprocessor level (over half a second is recommended).

**Figure 26. Restart timing without diagnostic enable (permanent) - Each 1 mS time, a sampling of the fault is done**

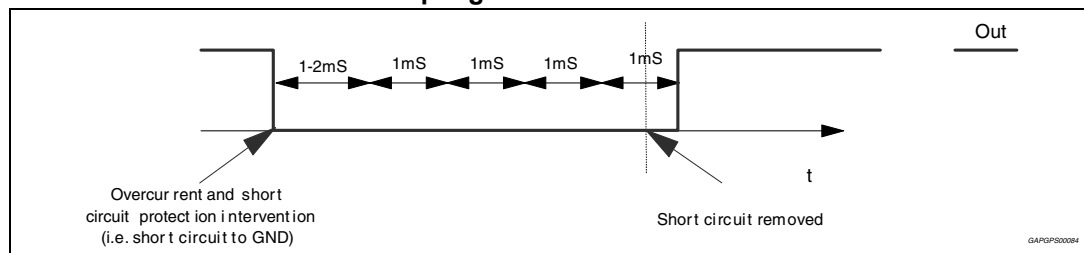

**Figure 27. Restart timing with diagnostic enable (permanent)**

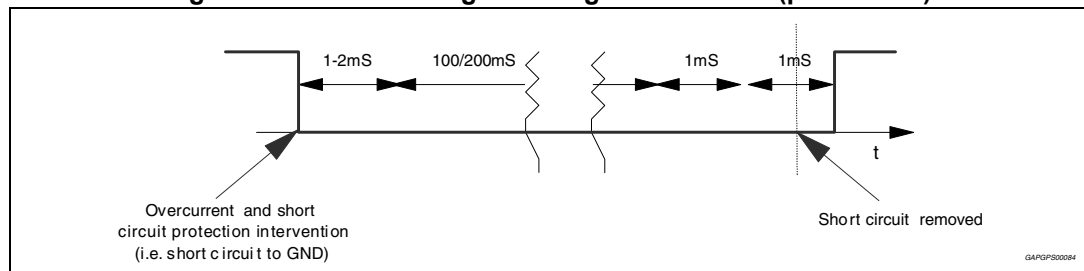

### 4.3 AC diagnostic

It is targeted at detecting accidental disconnection of tweeters in 2-way speaker and, more in general, presence of capacitive (AC) coupled loads.

This diagnostic is based on the notion that the overall speaker's impedance (woofer + parallel tweeter) will tend to increase towards high frequencies if the tweeter gets disconnected, because the remaining speaker (woofer) would be out of its operating range (high impedance). The diagnostic decision is made according to peak output current thresholds, and it is enabled by setting (IB2-D2) = 1. Two different detection levels are available:

- High current threshold IB2 (D7) = 0  
lout > 500 mApk = normal status  
lout < 250 mApk = open tweeter
- Low current threshold IB2 (D7) = 1  
lout > 250 mApk = normal status  
lout < 125 mApk = open tweeter

To correctly implement this feature, it is necessary to briefly provide a signal tone (with the amplifier in "play") whose frequency and magnitude are such to determine an output current higher than 500 mApk with IB2(D7) = 0 (higher than 250 mApk with IB2(D7) = 1) in normal conditions and lower than 250 mApk with IB2(D7) = 0 (lower than 125 mApk with IB2(D7)=1) should the parallel tweeter be missing.

The test has to last for a minimum number of 3 sine cycles starting from the activation of the AC diagnostic function IB2<D2> up to the I<sup>2</sup>C reading of the results (measuring period). To confirm presence of tweeter, it is necessary to find at least 3 current pulses over the above threshold over all the measuring period, else an "open tweeter" message will be issued.

The frequency / magnitude setting of the test tone depends on the impedance characteristics of each specific speaker being used, with or without the tweeter connected (to be calculated case by case). High-frequency tones (> 10 kHz) or even ultrasonic signals are recommended for their negligible acoustic impact and also to maximize the impedance module's ratio between with tweeter-on and tweeter-off.

*Figure 28* and *29* shows the load impedance as a function of the peak output voltage and the relevant diagnostic fields.

It is recommended to keep output voltage always below 8 V (high threshold case) or 4 V (low threshold case) to avoid the circuit to saturate (causing wrong detection cases).

This feature is disabled if any overload leading to activation of the short-circuit protection occurs in the process.

Figure 28. Current detection high: load impedance |Z| vs. output peak voltage

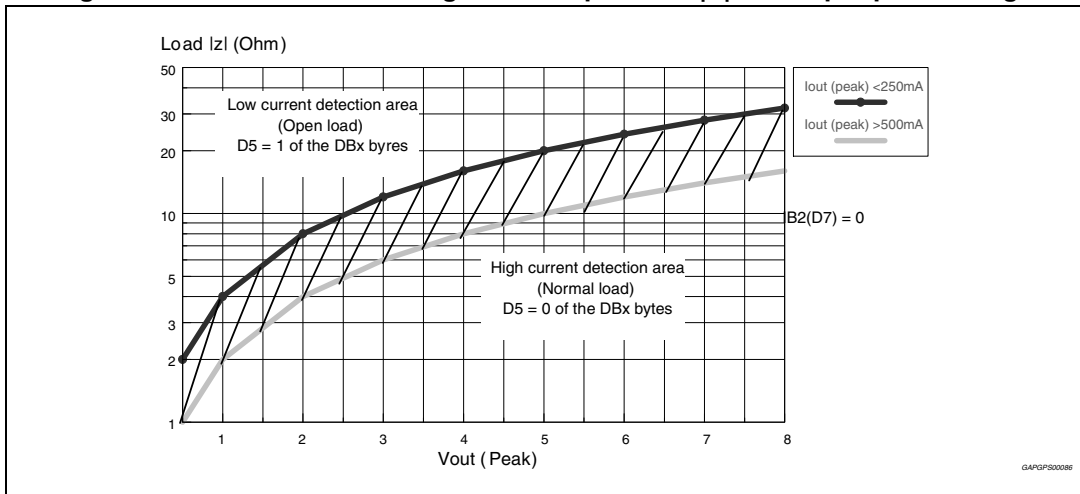
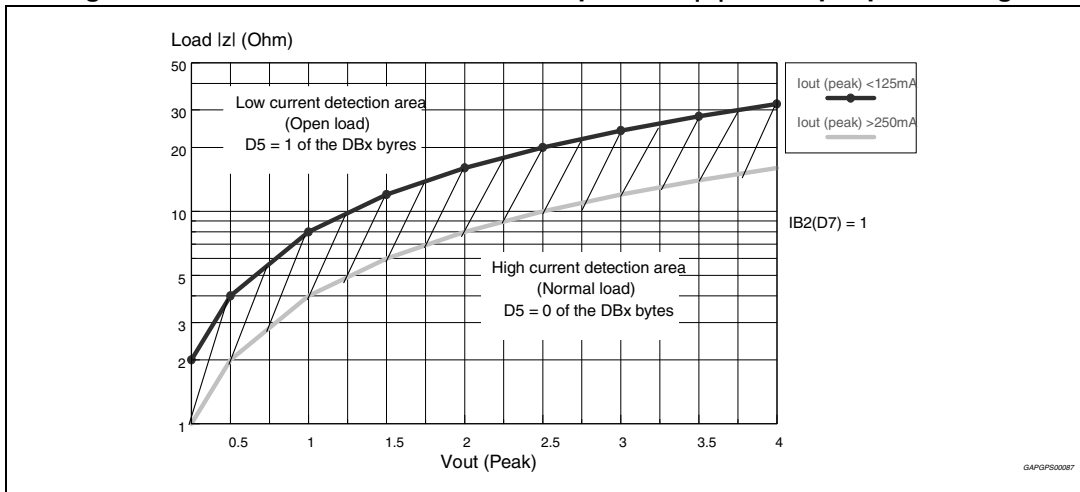

Figure 29. Current detection low: load impedance |Z| vs. output peak voltage



## 5 Output DC offset detection

The TDA75613LV can detect any DC output offset exceeding  $\pm 2$  V. This inconvenient might occur as a consequence of initially defective or aged and worn-out input capacitors feeding a DC component to the inputs, so putting the speakers at risk of overheating. Every time the power amplifier switches on, the SSR automatically mutes the device in case of offset. In play mode, the offset is signalled out on I<sup>2</sup>C bus.

### 5.1 Offset detection and mute at start-up, SSR (Speaker Safety Routine)

TDA75613LV embeds a speaker safety routine in order to protect the speakers in case of big output offset. This protection mechanism can automatically mute the device within 40 ms when it detects an offset bigger than 2 V at the output. No external circuit is required for this feature.

The SSR requires the MCU to turn on the audio power amplifier in a proper sequence. The MCU should at first turn on the device in MUTE condition and, after a suitable time to completely power on the device, which is about 1s, send a PLAY command to it and make sure there is no input signal applied to any of the inputs for at least 100 ms.

See [Figure 30](#). The power amplifier switches on and no input signal is applied. After 1 s the SVR is fully charged and the output dc voltage is set. The MCU sends the PLAY command and the offset, on all the channels, is checked. In case the detected offset is null or, anyhow, lower than 2 V, the power amplifier is kept alive and the audio signal can be applied after 100 ms.

**Figure 30. Power on sequence with a detected offset lower than 2 V**

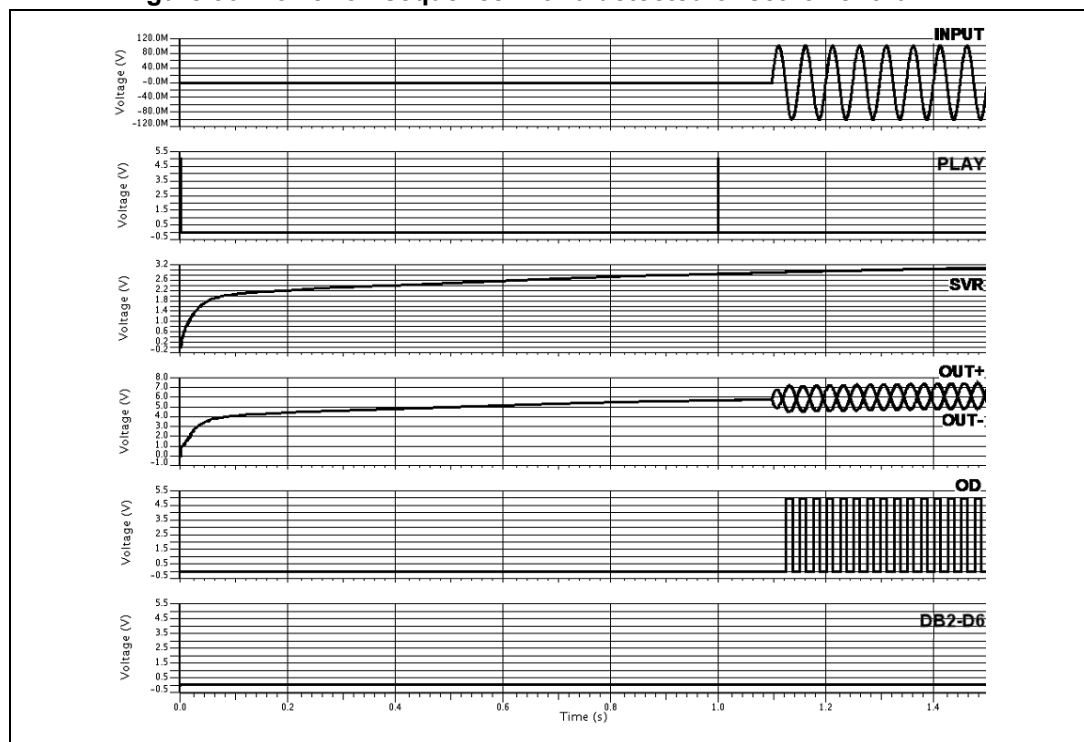

Look at the [Figure 31](#). The power amplifier switches on and no input signal is applied. After 1 s the SVR is fully charged and the output dc voltage is set. The MCU sends the PLAY command and the offset, on all the channels, is checked. If an offset bigger than 2 V is detected, the power amplifier is switched off within 40 ms.

**Figure 31. Power on sequence with a detected offset higher than 2 V**

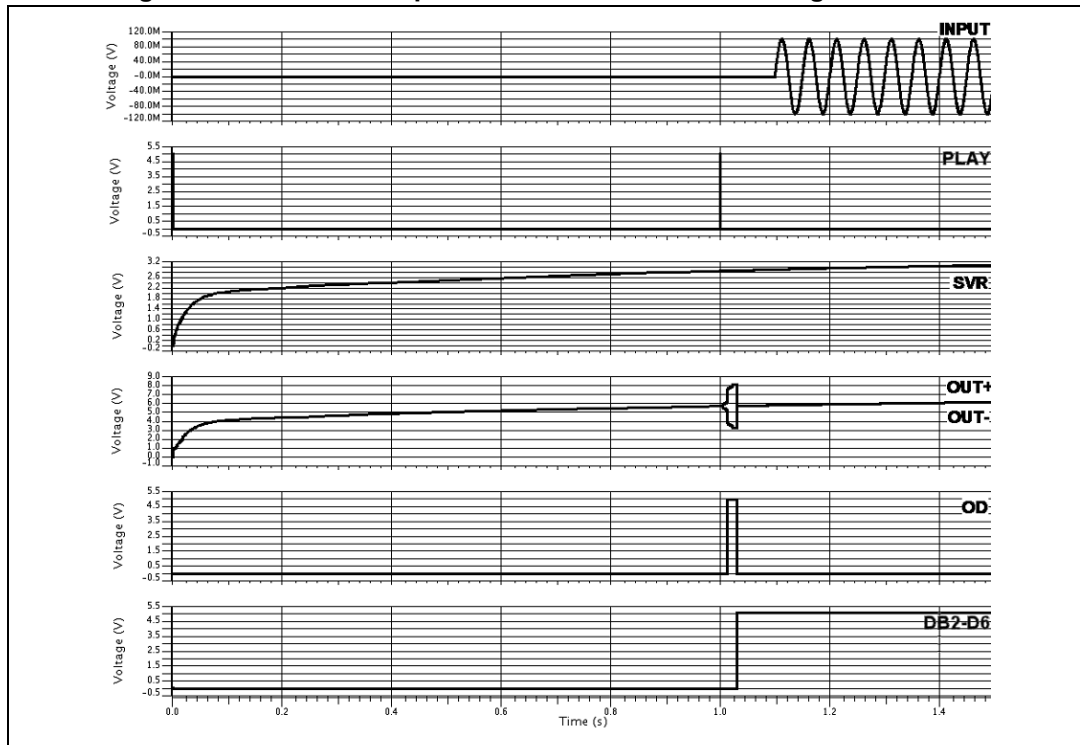

This action is pointed out on the I<sup>2</sup>C bus, bit DB2-D6. This flag is seen by the microcontroller which can take necessary actions.

A standby command (hardware or by I<sup>2</sup>C) can reset the power amplifier

## 5.2 Offset detection in normal operation

It is a diagnostics function which has to be performed with low-level output AC signal (or  $V_{in} = 0$ ).

The test is run with selectable time duration by microprocessor (from a "start" to a "stop" command):

- START = Last reading operation or setting IB1 - D5 - (OFFSET enable) to 1
- STOP = Actual reading operation

Excess offset is signalled out if it is persistent for all the assigned testing time. This feature is disabled if any overloads leading to activation of the short-circuit protection occurs in the process.

## 6 Multiple faults

When more misconnections are simultaneously in place at the audio outputs, it is guaranteed that at least one of them is initially read out. The others are notified after successive cycles of I<sup>2</sup>C reading and faults removal, provided that the diagnostic is enabled. This is true for both kinds of diagnostic (Turn-On and Permanent).

The table below shows all the couples of double-fault possible. It should be taken into account that a short circuit with the 4 ohm speaker unconnected is considered as double fault.

**Table 6. Double fault table for turn on diagnostic**

	S. GND	S. Vs	S. Across L.	Open L.
S. GND	S. GND	S. Vs + S. GND	S. GND	S. GND
S. Vs	/	S. Vs	S. Vs	S. Vs
S. Across L.	/	/	S. Across L.	N.A.
Open L.	/	/	/	Open L. (*)

In Permanent Diagnostic the table is the same, with only a difference concerning Open Load (\*), which is not among the recognizable faults. Should an Open Load be present during the device's normal working, it would be detected at a subsequent Turn-On Diagnostic cycle (i.e. at the successive Car Radio Turn-On).

### 6.1 Faults availability

All the results coming from I<sup>2</sup>C bus, by read operations, are the consequence of measurements inside a defined period of time. If the fault is stable throughout the whole period, it will be sent out.

To guarantee always resident functions, every kind of diagnostic cycle (Turn-On, Permanent, Offset) is activated again after any I<sup>2</sup>C reading operation. So, when the micro reads the I<sup>2</sup>C, a new cycle will be able to start, but the read data will come from the previous diag. cycle (i.e. The device is in Turn-On state, with a short to GND, then the short is removed and micro reads I<sup>2</sup>C. The short to GND is still present in bytes, because it is the result of the previous cycle. If another I<sup>2</sup>C reading operation occurs, the bytes do not show the short). In general to observe a change in Diagnostic bytes, two I<sup>2</sup>C reading operations are necessary.



## 7 Thermal protection

Thermal protection is implemented through thermal foldback ([Figure 32](#)).

Thermal foldback begins limiting the audio input to the amplifier stage as the junction temperatures rise above the normal operating range. This effectively limits the output power capability of the device thus reducing the temperature to acceptable levels without totally interrupting the operation of the device.

The output power will decrease to the point at which thermal equilibrium is reached. Thermal equilibrium will be reached when the reduction in output power reduces the dissipated power such that the die temperature falls below the thermal foldback threshold. Should the device cool, the audio level will increase until a new thermal equilibrium is reached or the amplifier reaches full power. Thermal foldback will reduce the audio output level in a linear manner.

Three thermal warnings are available through the I<sup>2</sup>C bus data. After thermal shut down threshold is reached, the CD could toggle (as shown in [Figure 32](#)) or stay low, depending on signal level.

**Figure 32. Thermal foldback diagram**

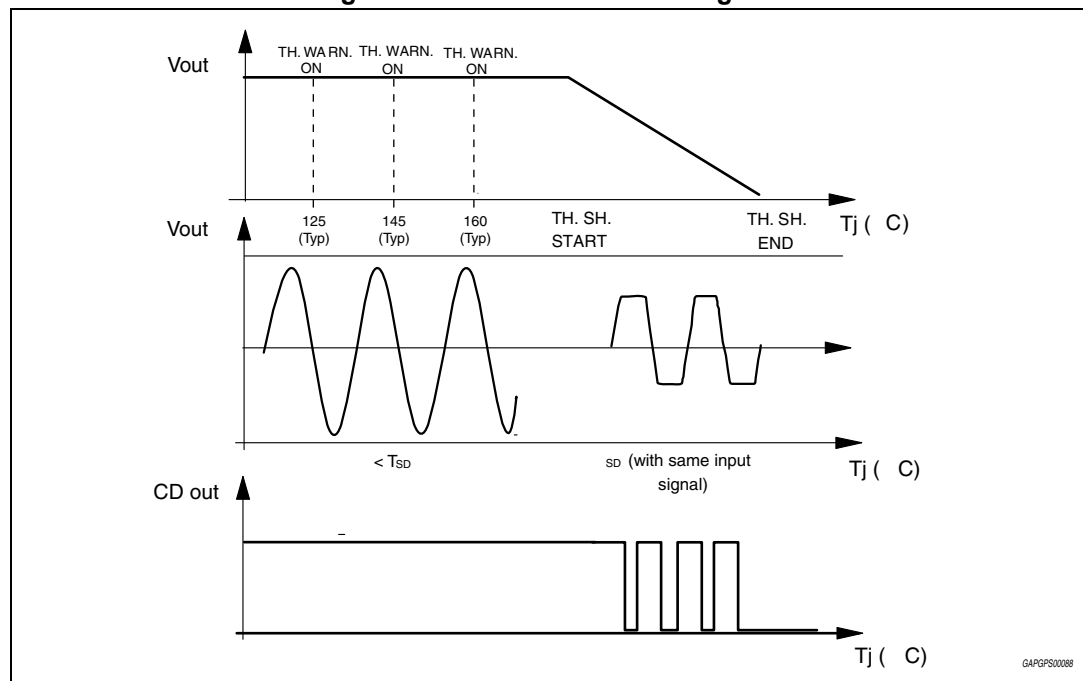

### 7.1 Fast muting

The muting time can be shortened to less than 1.5ms by setting (IB2) D5 = 1. This option can be useful in transient battery situations (i.e. during car engine cranking) to quickly turnoff the amplifier to avoid any audible effects caused by noise/transients being injected by preamp stages. The bit must be set back to "0" shortly after the mute transition.

## 8 Battery transitions management

### 8.1 Low voltage operation (“start stop”)

The most recent OEM specifications are requiring automatic stop of car engine at traffic light, in order to reduce emissions of polluting substances. The TDA75613LV, thanks to its innovating design, allows to go on playing sound when battery falls down to 6/7V during such conditions, without producing pop noise. The maximum system power will be reduced accordingly.

Supported battery cranking curves are shown below, indicating the shape and durations of allowed battery transitions.

**Figure 33. Worst case battery cranking curve sample 1**

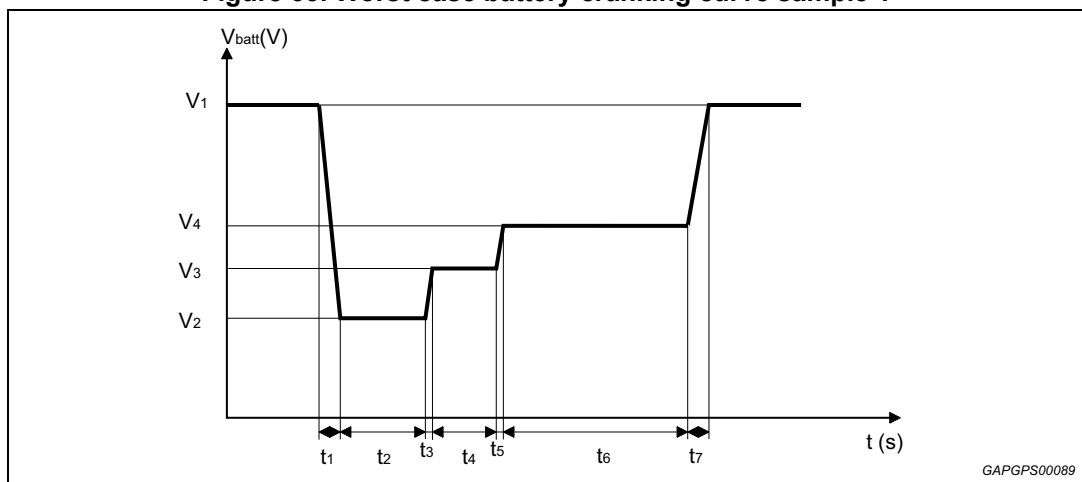

$V_1 = 12\text{ V}$ ;  $V_2 = 6\text{ V}$ ;  $V_3 = 7\text{ V}$ ;  $V_4 = 8\text{ V}$

$t_1 = 2\text{ ms}$ ;  $t_2 = 50\text{ ms}$ ;  $t_3 = 5\text{ ms}$ ;  $t_4 = 300\text{ ms}$ ;  $t_5 = 10\text{ ms}$ ;  $t_6 = 1\text{ s}$ ;  $t_7 = 2\text{ ms}$

**Figure 34. Worst case battery cranking curve sample 2**

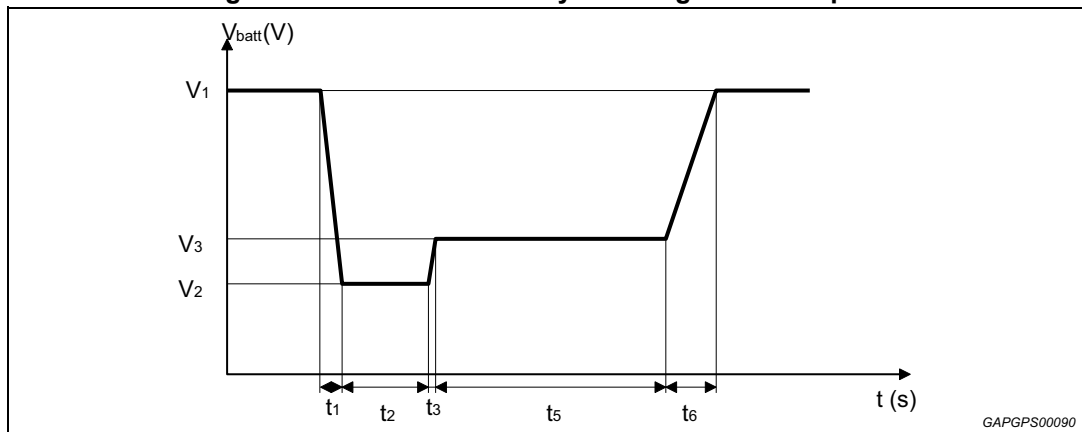

$V_1 = 12\text{ V}$ ;  $V_2 = 6\text{ V}$ ;  $V_3 = 7\text{ V}$

$t_1 = 2\text{ ms}$ ;  $t_2 = 5\text{ ms}$ ;  $t_3 = 15\text{ ms}$ ;  $t_5 = 1\text{ s}$ ;  $t_6 = 50\text{ ms}$

## 8.2 Advanced battery management

In addition to compatibility with low  $V_{batt}$ , the TDA75613LV is able to sustain upwards fast battery transitions (like the one showed in [Figure 35](#)) without causing unwanted audible effect, thanks to the innovative circuit topology.

**Figure 35. Upwards fast battery transitions diagram**

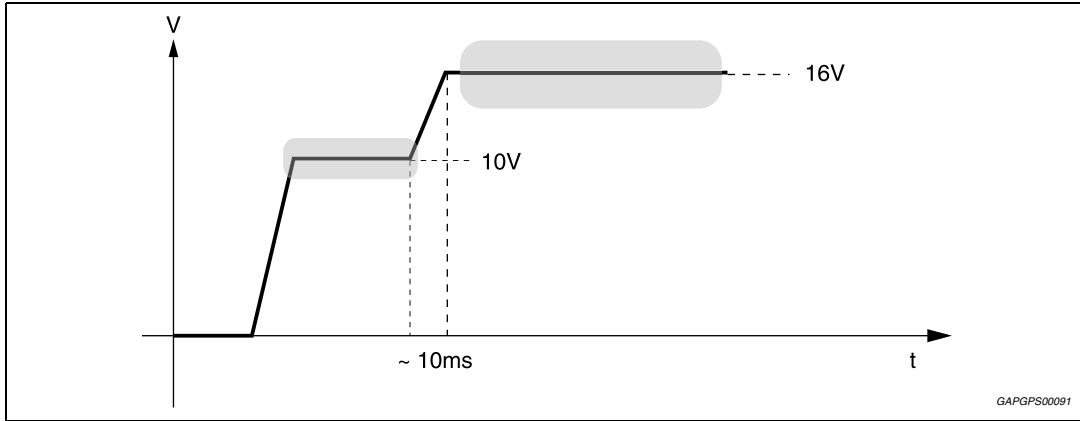

## 9 Application suggestion

### 9.1 High efficiency introduction

Thanks to its operating principle, the TDA75613LV obtains a substantial reduction of power dissipation from traditional class-AB amplifiers without being affected by the massive radiation effects and complex circuitry normally associated with class-D solutions.

The high efficiency operating principle is based on the use of bridge structures which are connected by means of a power switch. In particular, as shown in *Figure 36*, Ch1 is linked to Ch2, while Ch3 to Ch4. The switch, controlled by a logic circuit which senses the input signals, is closed at low volumes (output power steadily lower than 2.5 W) and the system acts like a "single bridge" with double load. In this case, the total power dissipation is a quarter of a double bridge.

Due to its structure, the highest efficiency level can be reached when symmetrical loads are applied on channels sharing the same switch.

**Figure 36. High efficiency - basic structure**

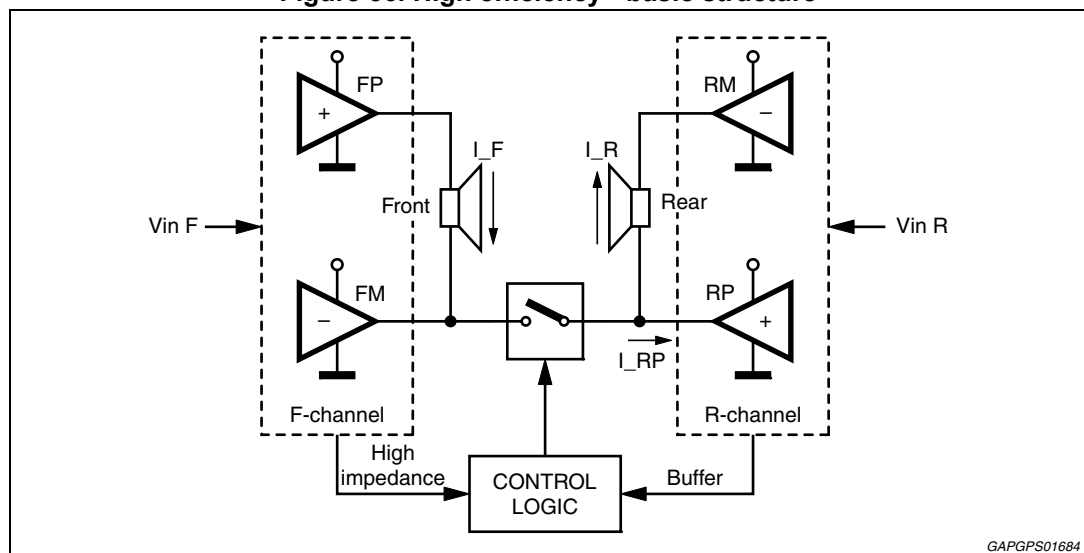

When the power demand increases to more than 2.5 W, the system behavior is switched back to a standard double bridge in order to guarantee the maximum output power, while in the 6 V start-stop devices the High Efficiency mode is automatically disabled at low  $V_{CC}$  ( $7.3\text{ V} \pm 0.3\text{ V}$ ). No need to re-program it when  $V_{CC}$  goes back to normal levels.

In the range 2-4 W (@  $V_{CC} = 14.4\text{ V}$ ,  $R_L = 4\Omega$ ), with the High Efficiency mode, the dissipated power gets up to 50 % less than the value obtained with the standard mode.

## 10 I<sup>2</sup>C bus

### 10.1 I<sup>2</sup>C programming/reading sequences

A correct turn on/off sequence with respect to of the diagnostic timings and producing no audible noises could be as follows (after battery connection):

- TURN-ON: PIN2 > 4.5 V - wait for 10 ms - (STAND-BY OUT + DIAG ENABLE) - wait for 1s - Muting out (play with no signal) - wait for 100 ms
- TURN-OFF: MUTING IN - wait for 50 ms - HW ST-BY IN (ST-BY pin  $\leq$  1.2 V)
- Car Radio Installation: PIN2 > 4.5 V - wait for 10 ms - DIAG ENABLE (write) - wait for 200 ms - I<sup>2</sup>C read (repeat until all faults disappear).

### 10.2 Address selection and I<sup>2</sup>C disable

When the ADSEL/I2CDIS pin is left open the I<sup>2</sup>C bus is disabled and the device can be controlled by the STBY/MUTE pin.

In this status (no - I<sup>2</sup>C bus) the CK pin enables the HIGH-EFFICIENCY MODE (0 = STD MODE; 1 = HE MODE) and the DATA pin sets the gain (0 = 30 dB; 1 = 16 dB).

When the ADSEL/I2CDIS pin is connected to GND the I<sup>2</sup>C bus is active with address <1101100-x>.

To select the other I<sup>2</sup>C address a resistor must be connected to ADSEL/I2CDIS pin as following:

0 < R < 1 k $\Omega$ : I<sup>2</sup>C bus active with address <1101100x>

11 k $\Omega$  < R < 21 k $\Omega$ : I<sup>2</sup>C bus active with address <1101101x>

40 k $\Omega$  < R < 70 k $\Omega$ : I<sup>2</sup>C bus active with address <1101110x>

R > 120 k $\Omega$ : Legacy mode

(x: read/write bit sector)

### 10.3 I<sup>2</sup>C bus interface

Data transmission from microprocessor to the TDA75613LV and viceversa takes place through the 2 wires I<sup>2</sup>C bus interface, consisting of the two lines SDA and SCL (pull-up resistors to positive supply voltage must be connected).

#### 10.3.1 Data validity

As shown by [Figure 37](#), the data on the SDA line must be stable during the high period of the clock. The HIGH and LOW state of the data line can only change when the clock signal on the SCL line is LOW.

#### 10.3.2 Start and stop conditions

As shown by [Figure 38](#) a start condition is a HIGH to LOW transition of the SDA line while SCL is HIGH. The stop condition is a LOW to HIGH transition of the SDA line while SCL is HIGH.

### 10.3.3 Byte format

Every byte transferred to the SDA line must contain 8 bits. Each byte must be followed by an acknowledge bit. The MSB is transferred first.

### 10.3.4 Acknowledge

The transmitter\* puts a resistive HIGH level on the SDA line during the acknowledge clock pulse (see [Figure 39](#)). The receiver\*\* has to pull-down (LOW) the SDA line during the acknowledge clock pulse, so that the SDA line is stable LOW during this clock pulse.

\* Transmitter

- master ( $\mu$ P) when it writes an address to the TDA75613LV
- slave (TDA75613LV) when the  $\mu$ P reads a data byte from TDA75613LV

\*\* Receiver

- slave (TDA75613LV) when the  $\mu$ P writes an address to the TDA75613LV
- master ( $\mu$ P) when it reads a data byte from TDA75613LV

**Figure 37. Data validity on the I<sup>2</sup>C bus**

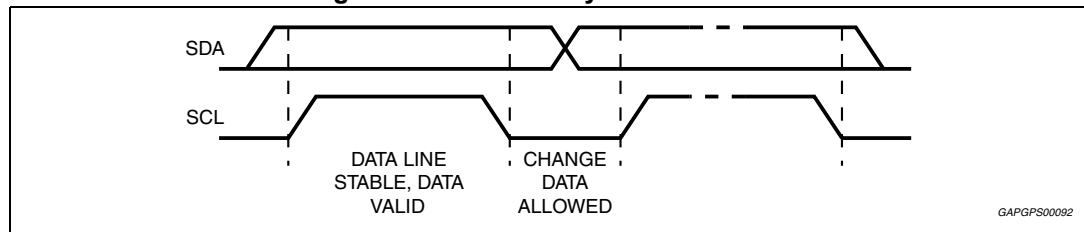

**Figure 38. Timing diagram on the I<sup>2</sup>C bus**

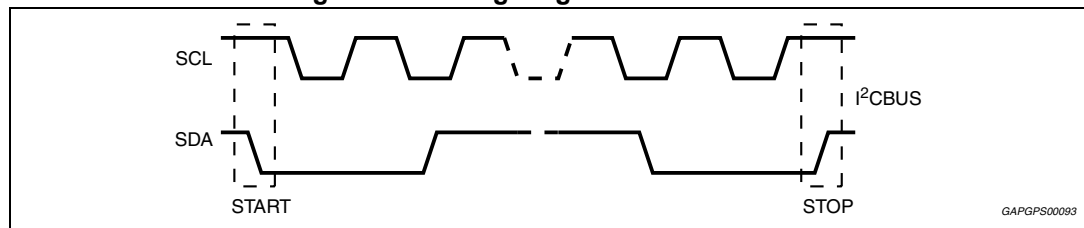

**Figure 39. Acknowledge on the I<sup>2</sup>C bus**

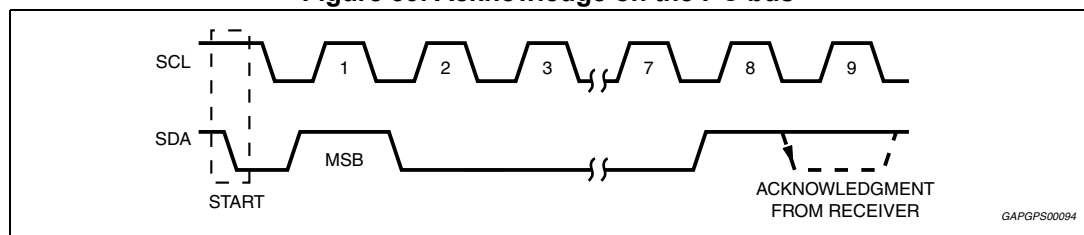

# 11 Software specifications

All the functions of the TDA75613LV are activated by I<sup>2</sup>C interface.

The bit 0 of the "ADDRESS BYTE" defines if the next bytes are write instruction (from μP to TDA75613LV) or read instruction (from TDA75613LV to μP).

## Chip address

D7							D0	
1	1	0	1	1	(*)	(*)	X	D8 Hex

X = 0 Write to device

X = 1 Read from device

If R/W = 0, the μP sends 2 "Instruction Bytes": IB1 and IB2.

(\*) address selector bit, please refer to address selection description on [Chapter 10.2](#).

**Table 7. IB1**

Bit	Instruction decoding bit
D7	Supply transition mute threshold high (D7 = 1) Supply transition mute threshold low (D7 = 0)
D6	Diagnostic enable (D6 = 1) Diagnostic defeat (D6 = 0)
D5	Offset Detection enable (D5 = 1) Offset Detection defeat (D5 = 0)
D4	Front Channel (CH1, CH3) Gain = 30 dB (D4 = 0) Gain = 16 dB (D4 = 1)
D3	Rear Channel (CH2, CH4) Gain = 30 dB (D3 = 0) Gain = 16 dB (D3 = 1)
D2	Mute front channels (D2 = 0) Unmute front channels (D2 = 1)
D1	Mute rear channels (D1 = 0) Unmute rear channels (D1 = 1)
D0	CD 2% (D0 = 0) CD 10% (D0 = 1)

Table 8. IB2

Bit	Instruction decoding bit
D7	Current detection threshold High th (D7 = 0) Low th (D7 =1)
D6	0
D5	Normal muting time (D5 = 0) Fast muting time (D5 = 1)
D4	Stand-by on - Amplifier not working - (D4 = 0) Stand-by off - Amplifier working - (D4 = 1)
D3	Power amplifier mode diagnostic (D3 = 0) Line driver mode diagnostic (D3 = 1)
D2	Current Detection Diagnostic Enabled (D2 =1) Current Detection Diagnostic Defeat (D2 =0)
D1	Right Channel Power amplifier working in standard mode (D1 = 0) Power amplifier working in high efficiency mode (D1 = 1)
D0	Left Channel Power amplifier working in standard mode (D0 = 0) Power amplifier working in high efficiency mode (D0 = 1)

If R/W = 1, the TDA75613LV sends 4 "Diagnostics Bytes" to  $\mu$ P: DB1, DB2, DB3 and DB4.

Table 9. DB1

Bit	Instruction decoding bit	
D7	Thermal warning 1 active (D7 = 1), $T_j = 160\text{ }^\circ\text{C}$ (Typ)	-
D6	Diag. cycle not activated or not terminated (D6 = 0) Diag. cycle terminated (D6 = 1)	-
D5	Channel LF (CH1) Current detection IB2 (D7) = 0 Output peak current < 250 mA - Open load (D5 = 1) Output peak current > 500 mA - Normal load (D5 = 0)	Channel LF (CH1) Current detection IB2 (D7) = 1 Output peak current < 125 mA - Open load (D5 = 1) Output peak current > 250 mA - Normal load (D5 = 0)
D4	Channel LF (CH1) Turn-on diagnostic (D4 = 0) Permanent diagnostic (D4 = 1)	-
D3	Channel LF (CH1) Normal load (D3 = 0) Short load (D3 = 1)	-
D2	Channel LF (CH1) Turn-on diag.: No open load (D2 = 0) Open load detection (D2 = 1) Offset diag.: No output offset (D2 = 0) Output offset detection (D2 = 1)	-



Table 9. DB1 (continued)

Bit	Instruction decoding bit	
D1	Channel LF (CH1) No short to Vcc (D1 = 0) Short to Vcc (D1 = 1)	-
D0	Channel LF (CH1) No short to GND (D1 = 0) Short to GND (D1 = 1)	-

Table 10. DB2

Bit	Instruction decoding bit	
D7	Offset detection not activated (D7 = 0) Offset detection activated (D7 = 1)	-
D6	Offset detected and automute (SSR) (D6=1)	-
D5	Channel LR (CH2) Current detection IB2 (D7) = 0 Output peak current < 250 mA - Open load (D5 = 1) Output peak current > 500 mA - Normal load (D5 = 0)	Channel LR (CH2) Current detection IB2 (D7) = 1 Output peak current < 125 mA - Open load (D5 = 1) Output peak current > 250 mA - Normal load (D5 = 0)
D4	Channel LR (CH2) Turn-on diagnostic (D4 = 0) Permanent diagnostic (D4 = 1)	-
D3	Channel LR (CH2) Normal load (D3 = 0) Short load (D3 = 1)	-
D2	Channel LR (CH2) Turn-on diag.: No open load (D2 = 0) Open load detection (D2 = 1) Permanent diag.: No output offset (D2 = 0) Output offset detection (D2 = 1)	-
D1	Channel LR (CH2) No short to Vcc (D1 = 0) Short to Vcc (D1 = 1)	-
D0	Channel LR (CH2) No short to GND (D1 = 0) Short to GND (D1 = 1)	-

Table 11. DB3

Bit	Instruction decoding bit	
D7	Standby status (= IB2 - D4)	-
D6	Diagnostic status (= IB1 - D6)	-
D5	Channel RF (CH3) Current detection IB2 (D7) = 0 Output peak current < 250 mA - Open load (D5 = 1) Output peak current > 500 mA - Normal load (D5 = 0)	Channel RF (CH3) Current detection IB2 (D7) = 1 Output peak current < 125 mA - Open load (D5 = 1) Output peak current > 250 mA - Normal load (D5 = 0)
D4	Channel RF (CH3) Turn-on diagnostic (D4 = 0) Permanent diagnostic (D4 = 1)	-
D3	Channel RF (CH3) Normal load (D3 = 0) Short load (D3 = 1)	-
D2	Channel RF (CH3) Turn-on diag.: No open load (D2 = 0) Open load detection (D2 = 1) Permanent diag.: No output offset (D2 = 0) Output offset detection (D2 = 1)	-
D1	Channel RF (CH3) No short to Vcc (D1 = 0) Short to Vcc (D1 = 1)	-
D0	Channel RF (CH3) No short to GND (D1 = 0) Short to GND (D1 = 1)	-

Table 12. DB4

Bit	Instruction decoding bit	
D7	Thermal warning 2 active (D7 = 1), $T_j = 145\text{ °C}$ (Typ)	-
D6	Thermal warning 3 active (D6 = 1) $T_j = 125\text{ °C}$ (Typ)	-
D5	Channel RR (CH4) Current detection IB2 (D7) = 0 Output peak current < 250 mA - Open load (D5 = 1) Output peak current > 500 mA - Normal load (D5 = 0)	Channel RR (CH4) Current detection IB2 (D7) = 1 Output peak current < 125 mA - Open load (D5 = 1) Output peak current > 250 mA - Normal load (D5 = 0)
D4	Channel RR (CH4) Turn-on diagnostic (D4 = 0) Permanent diagnostic (D4 = 1)	-
D3	Channel R (CH4) R Normal load (D3 = 0) Short load (D3 = 1)	-
D2	Channel RR (CH4) Turn-on diag.: No open load (D2 = 0) Open load detection (D2 = 1) Permanent diag.: No output offset (D2 = 0) Output offset detection (D2 = 1)	-
D1	Channel RR (CH4) No short to Vcc (D1 = 0) Short to Vcc (D1 = 1)	-
D0	Channel RR (CH4) No short to GND (D1 = 0) Short to GND (D1 = 1)	-

## 12 Examples of bytes sequence

1 - Turn-On diagnostic - Write operation

Start	Address byte with D0 = 0	ACK	IB1 with D6 = 1	ACK	IB2	ACK	STOP
-------	--------------------------	-----	-----------------	-----	-----	-----	------

2 - Turn-On diagnostic - Read operation

Start	Address byte with D0 = 1	ACK	DB1	ACK	DB2	ACK	DB3	ACK	DB4	ACK	STOP
-------	--------------------------	-----	-----	-----	-----	-----	-----	-----	-----	-----	------

The delay from 1 to 2 can be selected by software, starting from 1ms

3a - Turn-On of the power amplifier with 30 dB gain, mute on, diagnostic defeat, CD = 2%

Start	Address byte with D0 = 0	ACK	IB1	ACK	IB2	ACK	STOP
			X0000000		XXX1XX11		

3b - Turn-Off of the power amplifier

Start	Address byte with D0 = 0	ACK	IB1	ACK	IB2	ACK	STOP
			X0XXXXXX		XXX0XXXX		

4 - Offset detection procedure enable

Start	Address byte with D0 = 0	ACK	IB1	ACK	IB2	ACK	STOP
			XX1XX11X		XXX1XXXX		

5 - Offset detection procedure stop and reading operation (the results are valid only for the offset detection bits (D2 of the bytes DB1, DB2, DB3, DB4)

Start	Address byte with D0 = 1	ACK	DB1	ACK	DB2	ACK	DB3	ACK	DB4	ACK	STOP
-------	--------------------------	-----	-----	-----	-----	-----	-----	-----	-----	-----	------

- The purpose of this test is to check if a D.C. offset (2V typ.) is present on the outputs, produced by input capacitor with anomalous leakage current or humidity between pins.
- The delay from 4 to 5 can be selected by software, starting from 1ms

# 13 Package information

In order to meet environmental requirements, ST offers these devices in different grades of ECOPACK® packages, depending on their level of environmental compliance. ECOPACK® specifications, grade definitions and product status are available at: [www.st.com](http://www.st.com).

ECOPACK® is an ST trademark.

**Figure 40. Flexiwatt27 (vertical) mechanical data and package dimensions**

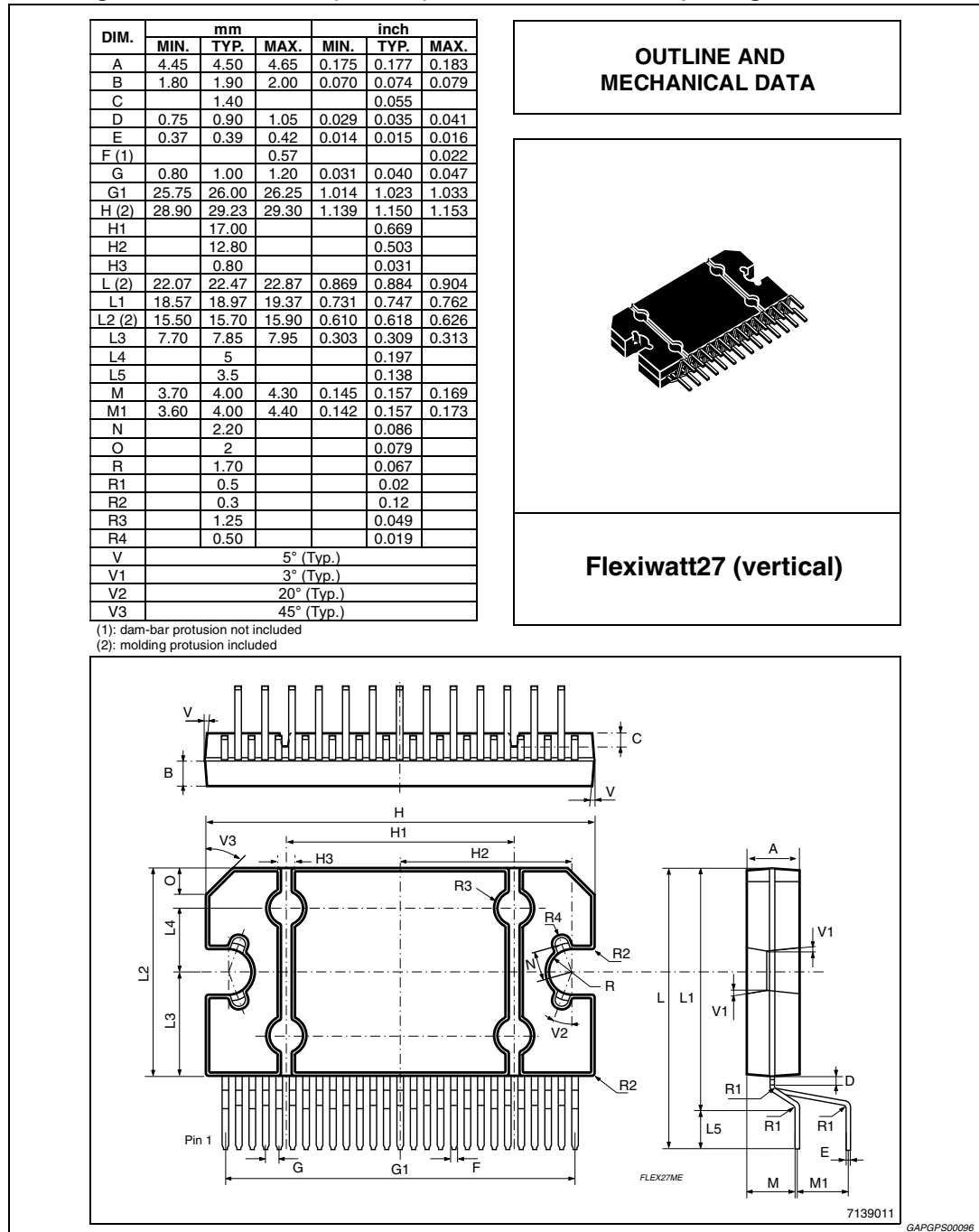

## 14 Revision history

Table 13. Document revision history

Date	Revision	Changes
05-Dec-2013	1	Initial release.
10-Feb-2014	2	Updated <a href="#">Section 10.1: I<sup>2</sup>C programming/reading sequences on page 29.</a>
28-Apr-2014	3	Updated <a href="#">Section 10.2: Address selection and I<sup>2</sup>C disable on page 29.</a>
07-Jul-2014	4	Modified <a href="#">Figure 2: Application circuit on page 6.</a> Added <a href="#">Section 3.4: Electrical characteristic curves on page 14.</a>
22-Sep-2014	5	Updated <a href="#">Section 10.1: I<sup>2</sup>C programming/reading sequences on page 29.</a>

**IMPORTANT NOTICE – PLEASE READ CAREFULLY**

STMicroelectronics NV and its subsidiaries ("ST") reserve the right to make changes, corrections, enhancements, modifications, and improvements to ST products and/or to this document at any time without notice. Purchasers should obtain the latest relevant information on ST products before placing orders. ST products are sold pursuant to ST's terms and conditions of sale in place at the time of order acknowledgement.

Purchasers are solely responsible for the choice, selection, and use of ST products and ST assumes no liability for application assistance or the design of Purchasers' products.

No license, express or implied, to any intellectual property right is granted by ST herein.

Resale of ST products with provisions different from the information set forth herein shall void any warranty granted by ST for such product.

ST and the ST logo are trademarks of ST. All other product or service names are the property of their respective owners.

Information in this document supersedes and replaces information previously supplied in any prior versions of this document.

© 2014 STMicroelectronics – All rights reserved



**Стандарт  
Электрон  
Связь**

Мы молодая и активно развивающаяся компания в области поставок электронных компонентов. Мы поставляем электронные компоненты отечественного и импортного производства напрямую от производителей и с крупнейших складов мира.

Благодаря сотрудничеству с мировыми поставщиками мы осуществляем комплексные и плановые поставки широчайшего спектра электронных компонентов.

Собственная эффективная логистика и склад в обеспечивает надежную поставку продукции в точно указанные сроки по всей России.

Мы осуществляем техническую поддержку нашим клиентам и предпродажную проверку качества продукции. На все поставляемые продукты мы предоставляем гарантию .

Осуществляем поставки продукции под контролем ВП МО РФ на предприятия военно-промышленного комплекса России , а также работаем в рамках 275 ФЗ с открытием отдельных счетов в уполномоченном банке. Система менеджмента качества компании соответствует требованиям ГОСТ ISO 9001.

Минимальные сроки поставки, гибкие цены, неограниченный ассортимент и индивидуальный подход к клиентам являются основой для выстраивания долгосрочного и эффективного сотрудничества с предприятиями радиоэлектронной промышленности, предприятиями ВПК и научно-исследовательскими институтами России.

С нами вы становитесь еще успешнее!

**Наши контакты:**

**Телефон:** +7 812 627 14 35

**Электронная почта:** [sales@st-electron.ru](mailto:sales@st-electron.ru)

**Адрес:** 198099, Санкт-Петербург,  
Промышленная ул, дом № 19, литера Н,  
помещение 100-Н Офис 331