

Shock-Safe Fuseholder, 5 x 20 mm, Slotted Cap/Fingergrip, horizontal, IEC 60335-1



Closed fuseholder 5 x 20 mm horizontal with slot



Solder terminal from front side horizontal with finger grip

250 VAC · 2.5W/10A (VDE) · 500V · 16A (UL/CSA)

See below:
[Approvals and Compliances](#)

Description

- Compact design
- Horizontal style
- Heading with fingergrip and slotted available

Applications

- Household appliances
- Medical Equipment

Weblinks

[pdf data sheet](#), [html datasheet](#), [General Product Information](#), [Packaging details](#), [Distributor-Stock-Check](#), [Detailed request for product](#), [Microsite](#)

Technical Data

| | |
|------------------------------|---|
| Shock-Safe Category | PC2 |
| Fuse-Link | 5 x 20 mm |
| Mounting | PCB |
| Terminal | Solder THT |
| Rated Voltage | 250VAC , 500V (UL/CSA) |
| Rated current | 10A (VDE), 16A (UL/CSA) |
| Rated Power Acceptance IEC | 2.5W / 10A @ Ta 23 °C Admissible power acceptance at higher ambient temperature see derating curves |
| Degree of Protection | IP 40 |
| Protection Class | Suitable for appliances with protection class I acc. to IEC 61140 |
| Admissible Ambient Air Temp. | -40 °C to 85 °C |
| Climatic Category | 40/085/21 acc. to IEC 60068-1 |
| Material: Socket | Thermoplastic, black, UL 94V-0 |
| Material: Terminals | Tin-Plated Copper Alloy |
| Unit Weight | 4.31 g |
| Storage Conditions | 0 °C to 60 °C, max. 70% r.h. |
| Product Marking |  Type, Rated Voltage, Power Acc./Current Rating, Certification marks |

| | |
|------------------------------|--|
| Soldering Methods | Wave Soldering Profile |
| Solderability | 235 °C / 2 sec acc. to IEC 60068-2-20, Test Ta, method 1 |
| Resistance to Soldering Heat | 260 °C / 10 sec acc. to IEC 60068-2-20, Test Tb, method 1A |
| Contact Resistance | ≤ 10 mΩ at 100 mA acc. to IEC 60127-6 |
| Dielectric Strength | > 3kV (50Hz: 1 min) |
| Impulse Withstand Voltage | > 2.5kV between L-N |
| Insulation Resistance | > 10 MΩ between L-N (500VDC: 1 min) |
| Overvoltage Category | II acc. to IEC 60664-1 |
| Pollution Degree | 2 acc. to IEC 60664-1 |
| Resistance to Vibration | acc. to IEC 60068-2-6, test Fc |

Approvals and Compliances



Detailed information on product approvals, code requirements, usage instructions and detailed test conditions can be looked up in [Details about Approvals](#)

SCHURTER products are designed for use in industrial environments. They have approvals from independent testing bodies according to national and international standards. Products with specific characteristics and requirements such as required in the automotive sector according to IATF 16949, medical technology according to ISO 13485 or in the aerospace industry can be offered exclusively with customer-specific, individual agreements by SCHURTER.

Approvals

The approval mark is used by the testing authorities to certify compliance with the safety requirements placed on electronic products.

Approval Reference Type: FPG5

| Approval Logo | Certificates | Certification Body | Description |
|---|-------------------------------|--------------------|----------------------------------|
|  | VDE Approvals | VDE | VDE Certificate Number: 40044101 |
|  | UL Approvals | UL | UL File Number: E39328 |



Product standards

Product standards that are referenced

| Organization | Design | Standard | Description |
|--|-----------------------|----------------------|--|
|  | Designed according to | IEC 60127-6 | Miniature fuses. Part 6. Fuse-holders for miniature fuse-links |
|  | Designed according to | UL 4248-1 | Fuseholder general requirements |
|  | Designed according to | CSA C22.2 no. 4248.1 | Fuseholder general requirements |





Application standards

Application standards where the product can be used

| Organization | Design | Standard | Description |
|--|--------------------------------|----------------|--|
|  | Designed for applications acc. | IEC/UL 62368-1 | IEC 62368-1 includes the basic requirements for safety of audio, video, information technology and office equipment. |
|  | Designed for applications acc. | IEC 60335-1 | Safety of electrical appliances for household and similar purposes. Meets the requirements for appliances in unattended use. This includes the enhanced requirements of glow wire tests acc. to IEC 60695-2-11 or -12 & -13. |

Compliances

The product complies with following Guide Lines

| Identification | Details | Initiator | Description |
|--|--|-------------|---|
|  | CE declaration of conformity | SCHURTER AG | The CE marking declares that the product complies with the applicable requirements laid down in the harmonisation of Community legislation on its affixing in accordance with EU Regulation 765/2008. |
|  | RoHS | SCHURTER AG | Directive RoHS 2011/65/EU, Amendment (EU) 2015/863 |
|  | China RoHS | SCHURTER AG | The law SJ / T 11363-2006 (China RoHS) has been in force since 1 March 2007. It is similar to the EU directive RoHS. |
|  | REACH | SCHURTER AG | On 1 June 2007, Regulation (EC) No 1907/2006 on the Registration, Evaluation, Authorization and Restriction of Chemicals 1 (abbreviated as "REACH") entered into force. |
|  | White Paper Glow wire test | SCHURTER AG | Meets the requirements of IEC 60335-1 for appliances in unattended use. This includes the enhanced requirements of glow wire tests acc. to IEC 60695-2-11 or -12 & -13. |

Dimension [mm]

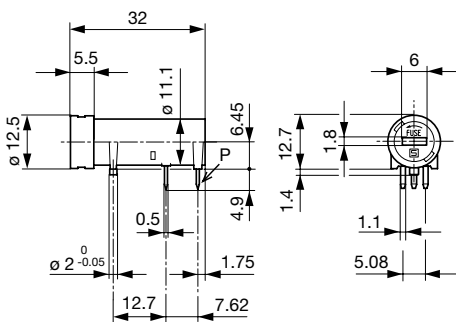

Variant 3101.0050

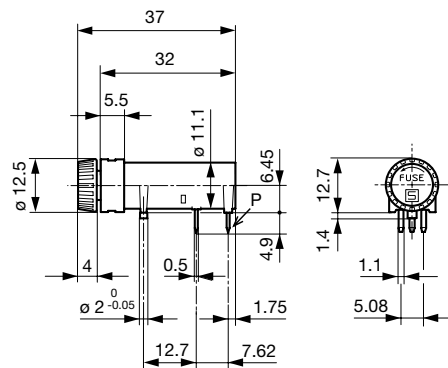

Variant Fingergrip 3101.0055 / Connector tinned

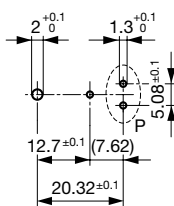

Drilling diagram

Derating Curves

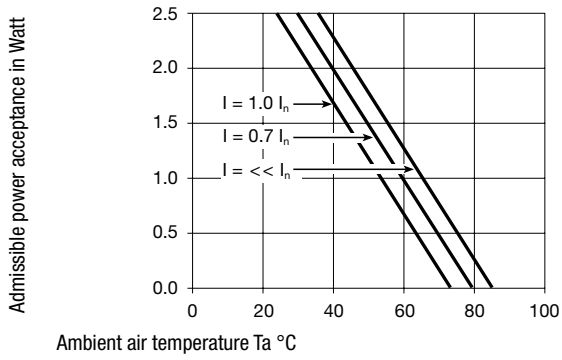

All Variants

| Holder | Cap | Terminal | Material | Remark | Order Number |
|--------|------------|----------|---------------|--------|--------------|
| ● | slotted | straight | Thermoplastic | - | 3101.0050 |
| ● | Fingergrip | straight | Thermoplastic | - | 3101.0055 |

Most Popular.

Availability for all products can be searched real-time: <https://www.schurter.com/en/Stock-Check/Stock-Check-SCHURTER>

Packaging Unit Bulk 186 x 91 x 91 mm (100 pcs.)



Стандарт Электрон Связь

Мы молодая и активно развивающаяся компания в области поставок электронных компонентов. Мы поставляем электронные компоненты отечественного и импортного производства напрямую от производителей и с крупнейших складов мира.

Благодаря сотрудничеству с мировыми поставщиками мы осуществляем комплексные и плановые поставки широчайшего спектра электронных компонентов.

Собственная эффективная логистика и склад в обеспечивает надежную поставку продукции в точно указанные сроки по всей России.

Мы осуществляем техническую поддержку нашим клиентам и предпродажную проверку качества продукции. На все поставляемые продукты мы предоставляем гарантию .

Осуществляем поставки продукции под контролем ВП МО РФ на предприятия военно-промышленного комплекса России , а также работаем в рамках 275 ФЗ с открытием отдельных счетов в уполномоченном банке. Система менеджмента качества компании соответствует требованиям ГОСТ ISO 9001.

Минимальные сроки поставки, гибкие цены, неограниченный ассортимент и индивидуальный подход к клиентам являются основой для выстраивания долгосрочного и эффективного сотрудничества с предприятиями радиоэлектронной промышленности, предприятиями ВПК и научно-исследовательскими институтами России.

С нами вы становитесь еще успешнее!

Наши контакты:

Телефон: +7 812 627 14 35

Электронная почта: sales@st-electron.ru

Адрес: 198099, Санкт-Петербург,
Промышленная ул, дом № 19, литера Н,
помещение 100-Н Офис 331