

STRADA-T-DN

Beam for area lighting with shorter illumination distances optimized for CREE XP-G and XP-E

TECHNICAL SPECIFICATIONS:

Dimensions	19.6 x 15.5 mm
Height	8.8 mm
Fastening	glue, pin, screw
ROHS compliant	yes ⓘ

MATERIAL SPECIFICATIONS:

Component	Type	Material	Colour	Finish
STRADA-T-DN	Single lens	PMMA	clear	



ORDERING INFORMATION:

Component	Qty in box	MOQ	MPQ	Box weight (kg)
C11415_STRADA-T-DN » Box size: 480 x 280 x 300 mm	2880	288	144	5.6

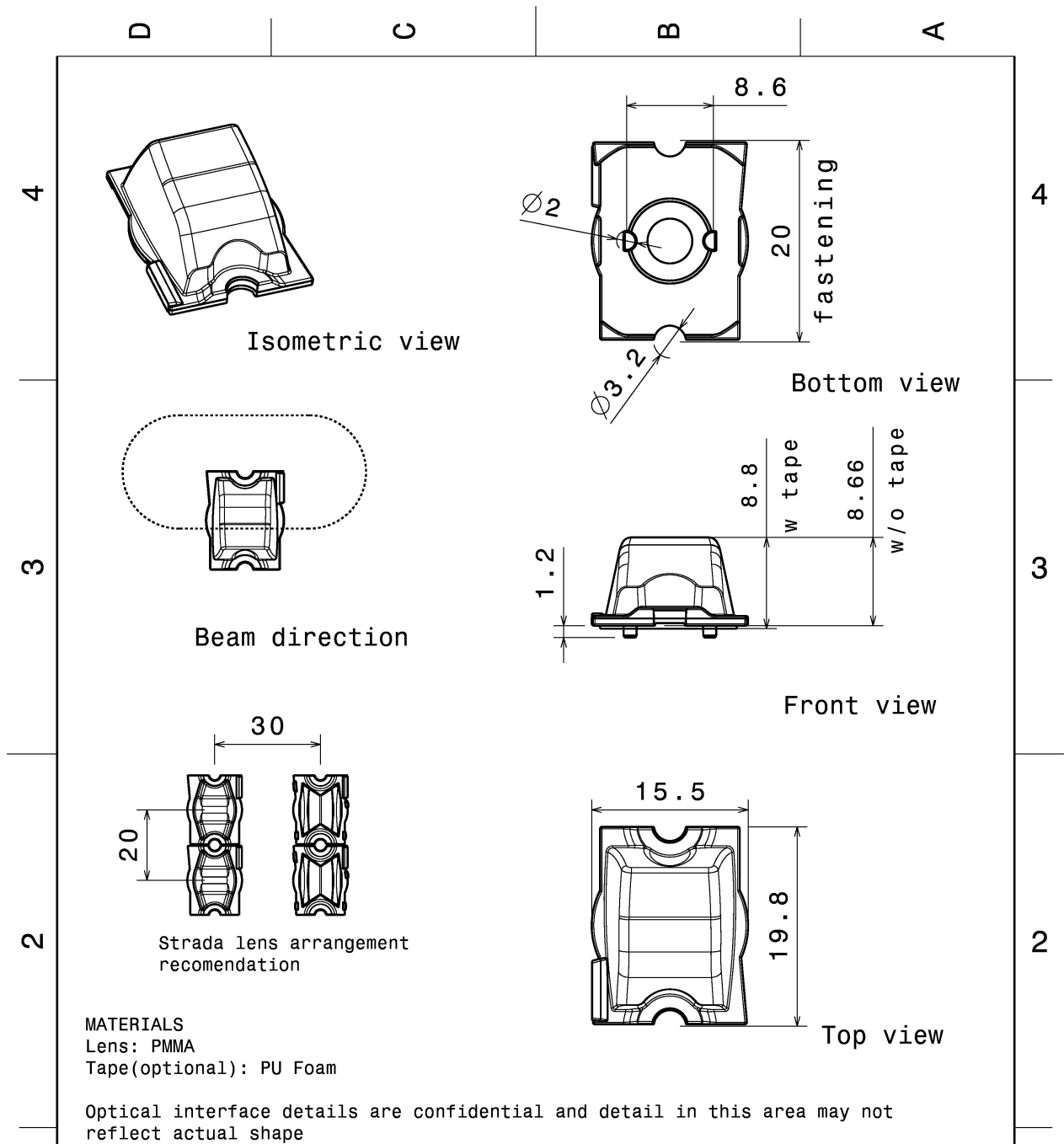

This drawing is our property. It can't be reproduced or communicated without our written agreement.		LEDiL		Ledil Oy Salorankatu 10 FIN-24100 SALO Finland	
DRAWING TITLE					
DRAWN BY ah		DATE 26.9.2012		Datasheet Strada-T-DN Lens	
CHECKED BY sn		DATE 26.9.2012		REV 2	
DESIGNED BY hh		DATE 14.05.2010		SCALE 2:1	
		WEIGHT (g)		SHEET 1/1	

PHOTOMETRIC DATA (MEASURED):



LED XP-E
FWHM Asymmetric
Efficiency 92 %
LEDs/each optic 1
Light colour White
Required components:

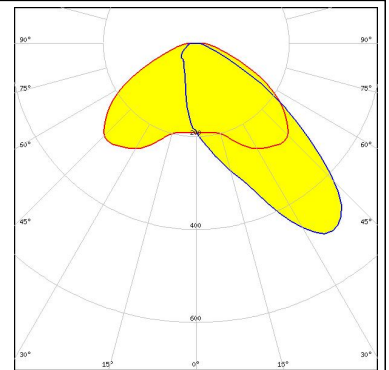

LED XP-G
FWHM Asymmetric
Efficiency 92 %
LEDs/each optic 1
Light colour White
Required components:

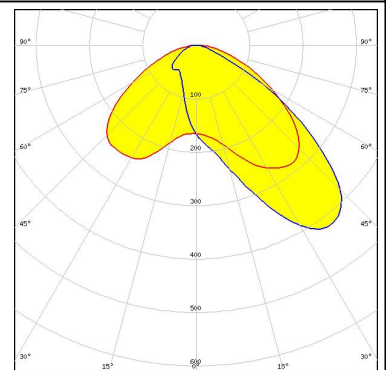

LED LUXEON A
FWHM Asymmetric
Efficiency 92 %
LEDs/each optic 1
Light colour White
Required components:



LED LUXEON Rebel
FWHM Asymmetric
Efficiency 92 %
LEDs/each optic 1
Light colour White
Required components:

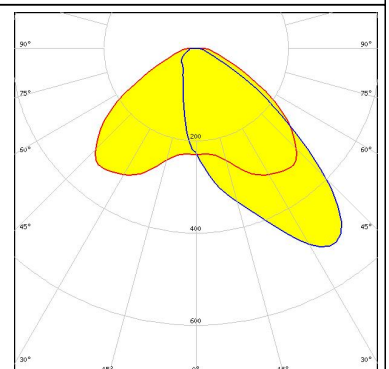

PHOTOMETRIC DATA (MEASURED):



LED LUXEON Rebel ES
FWHM Asymmetric
Efficiency 92 %
LEDs/each optic 1
Light colour White
Required components:

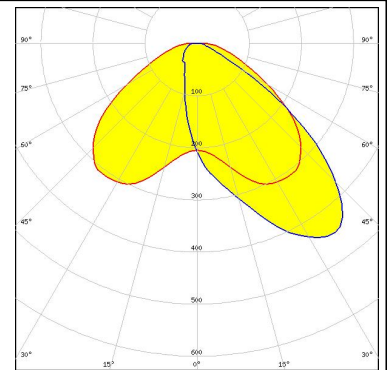

LED NCSxx19A
FWHM Asymmetric
Efficiency 92 %
LEDs/each optic 1
Light colour White
Required components:



LED NVSxx19A
FWHM Asymmetric
Efficiency 92 %
LEDs/each optic 1
Light colour White
Required components:



LED OSLOM Square PC
FWHM Asymmetric
Efficiency 93 %
LEDs/each optic 1
Light colour White
Required components:

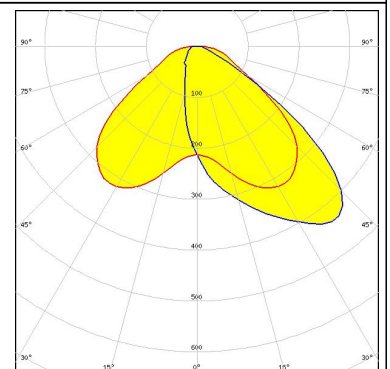

PHOTOMETRIC DATA (MEASURED):

OSRAM
Opto Semiconductors

LED OSLON SSL 150
FWHM Asymmetric
Efficiency 92 %
LEDs/each optic 1
Light colour White
Required components:

SEOUL SEMICONDUCTOR

LED Z5
FWHM Asymmetric
Efficiency 92 %
LEDs/each optic 1
Light colour White
Required components:

SHARP

LED Double Dome (GM2BB)
FWHM Asymmetric
Efficiency 92 %
LEDs/each optic 1
Light colour White
Required components:

PHOTOMETRIC DATA (SIMULATED):



LED NVSxE21A
FWHM Asymmetric
Efficiency 92 %
Peak intensity 0.6 cd/lm
LEDs/each optic 1
Light colour White
Required components:

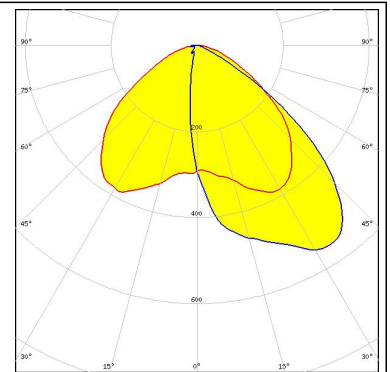

LED OSOLON SSL 80
FWHM Asymmetric
Efficiency 94 %
Peak intensity 0.5 cd/lm
LEDs/each optic 1
Light colour White
Required components:

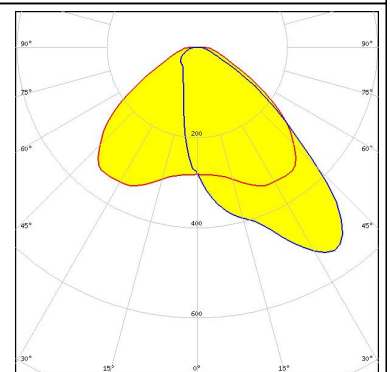

GENERAL INFORMATION:

NOTE: The typical beam angle will be changed by different color, chip size and chip position tolerance. The typical total beam angle is the full angle measured where the luminous intensity is half of the peak value.

MATERIALS:

As part of our continuous research and improvement processes, and to ensure the best possible quality and availability of our products, LEDiL reserves the right to change material grades without notice.

PRODUCT DATA USER AGREEMENT AND DISCLAIMER:

The measured data in the provided downloadable LEDiL Product Datasheets and Mechanical 2D-Drawings is rounded and provided as reference for planning. LEDiL Oy's optical specifications have been verified by conducting performance testing of the products in accordance with the company's quality system. The reported data are averaged results of multiple measurements with typical variation. LEDiL Oy reserves the right to without prior notification make changes and improvements to its products.

LEDiL Oy assumes neither warranty, nor guarantee nor any other liability of any kind for the contents and correctness of the provided data. The provided data has been generated with highest diligence but the provided data may in reality not represent the complete possible variation range of all intrinsic parameters. Therefore, in certain cases a deviation from the provided data could occur.

LEDiL Oy reserves the right to undertake technical changes of its products without further notification which could lead to changes in the provided data. LEDiL Oy assumes no liability of any kind for the possible deviation from any provided data or any other damage resulting from the usage of the provided data.

The user agrees to this disclaimer and user agreement with the download or usage of the provided files.

LEDiL Oy

Joensuunkatu 13
FI-24240 SALO
Finland

LEDiL Inc.

228 West Page Street
Suite D
Sycamore IL 60178
USA

Local sales and technical support

[www.ledil.com/
where_to_buy](http://www.ledil.com/where_to_buy)

Shipping locations

Salo, Finland
Hong Kong, China

Distribution Partners

[www.ledil.com/
where_to_buy](http://www.ledil.com/where_to_buy)



Стандарт Электрон Связь

Мы молодая и активно развивающаяся компания в области поставок электронных компонентов. Мы поставляем электронные компоненты отечественного и импортного производства напрямую от производителей и с крупнейших складов мира.

Благодаря сотрудничеству с мировыми поставщиками мы осуществляем комплексные и плановые поставки широчайшего спектра электронных компонентов.

Собственная эффективная логистика и склад в обеспечивает надежную поставку продукции в точно указанные сроки по всей России.

Мы осуществляем техническую поддержку нашим клиентам и предпродажную проверку качества продукции. На все поставляемые продукты мы предоставляем гарантию .

Осуществляем поставки продукции под контролем ВП МО РФ на предприятия военно-промышленного комплекса России , а также работаем в рамках 275 ФЗ с открытием отдельных счетов в уполномоченном банке. Система менеджмента качества компании соответствует требованиям ГОСТ ISO 9001.

Минимальные сроки поставки, гибкие цены, неограниченный ассортимент и индивидуальный подход к клиентам являются основой для выстраивания долгосрочного и эффективного сотрудничества с предприятиями радиоэлектронной промышленности, предприятиями ВПК и научно-исследовательскими институтами России.

С нами вы становитесь еще успешнее!

Наши контакты:

Телефон: +7 812 627 14 35

Электронная почта: sales@st-electron.ru

Адрес: 198099, Санкт-Петербург,
Промышленная ул, дом № 19, литера Н,
помещение 100-Н Офис 331