

InGaP HBT GAIN BLOCK MMIC AMPLIFIER, DC - 6 GHz

Typical Applications

The HMC311LP3(E) is ideal for:

- Cellular / PCS / 3G
- Fixed Wireless & WLAN
- CATV & Cable Modem
- Microwave Radio

Features

- P1dB Output Power: +15.5 dBm
- Output IP3: +32 dBm
- Gain: 14.5 dB
- 50 Ohm I/O's
- 16 Lead 3x3mm SMT Package: 9mm²

Functional Diagram

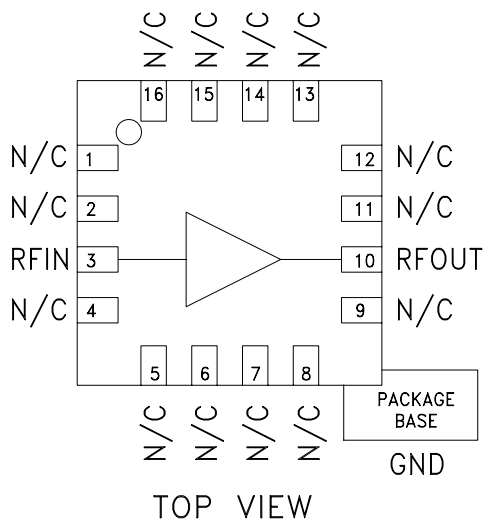

General Description

The HMC311LP3(E) is a GaAs InGaP Heterojunction Bipolar Transistor (HBT) Gain Block MMIC SMT DC to 6 GHz amplifiers. This 3x3mm QFN packaged amplifier can be used as either a cascadable 50 Ohm gain stage or to drive the LO of HMC mixers with up to +17 dBm output power. The HMC311LP3(E) offers 14.5 dB of gain and an output IP3 of +32 dBm while requiring only 56 mA from a +5V supply. The Darlington feedback pair used results in reduced sensitivity to normal process variations and yields excellent gain stability over temperature while requiring a minimal number of external bias components.

Electrical Specifications, $V_s = 5V$, $R_{bias} = 22 \text{ Ohm}$, $T_A = +25^\circ \text{ C}$

Parameter		Min.	Typ.	Max.	Units
Gain	DC - 1.0 GHz	13.0	14.5		dB
	1.0 - 4.0 GHz	12.5	14.3		dB
	4.0 - 6.0 GHz	12.0	14.0		dB
Gain Variation Over Temperature	DC - 2.0 GHz		0.005	0.008	dB/ °C
	2.0 - 4.0 GHz		0.008	0.012	dB/ °C
	4.0 - 6.0 GHz		0.012	0.016	dB/ °C
Return Loss Input / Output	DC - 1.0 GHz		13		dB
	1.0 - 3.0 GHz		11		dB
	3.0 - 6.0 GHz		15		dB
Reverse Isolation	DC - 6 GHz		18		dB
Output Power for 1 dB Compression (P1dB)	DC - 2.0 GHz	13.5	15.5		dBm
	2.0 - 4.0 GHz	12.0	15.0		dBm
	4.0 - 6.0 GHz	10.0	13.0		dBm
Output Third Order Intercept (IP3)	DC - 1.0 GHz		32		dBm
	1.0 - 2.0 GHz		30		dBm
	2.0 - 4.0 GHz		28		dBm
	4.0 - 6.0 GHz		24		dBm
Noise Figure	DC - 6 GHz		4.5		dB
Supply Current (Icq)			55	74	mA

Note: Data taken with broadband bias tee on device output.

**InGaP HBT GAIN BLOCK
MMIC AMPLIFIER, DC - 6 GHz**

Gain & Return Loss

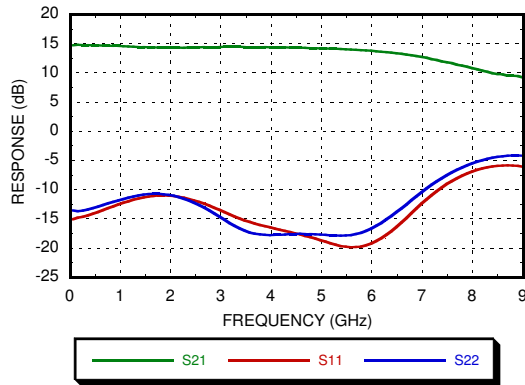

Gain vs. Temperature

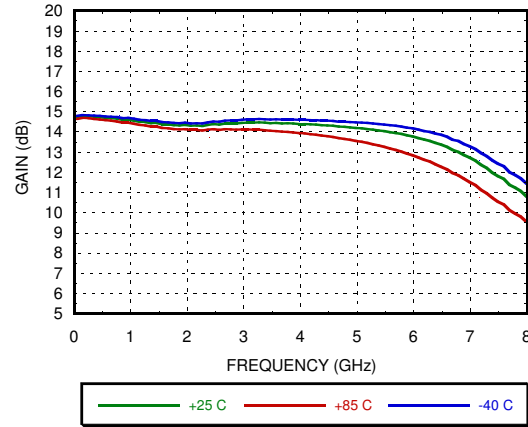

Input Return Loss vs. Temperature

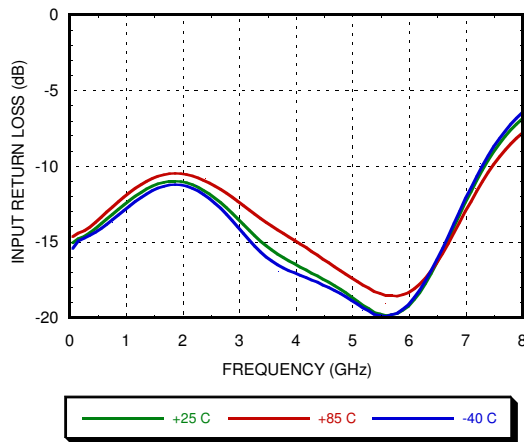

Output Return Loss vs. Temperature

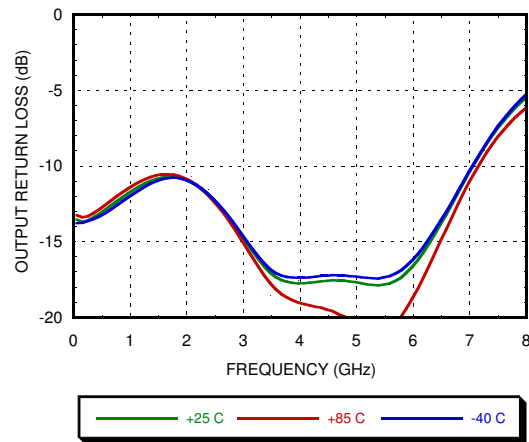

Reverse Isolation vs. Temperature

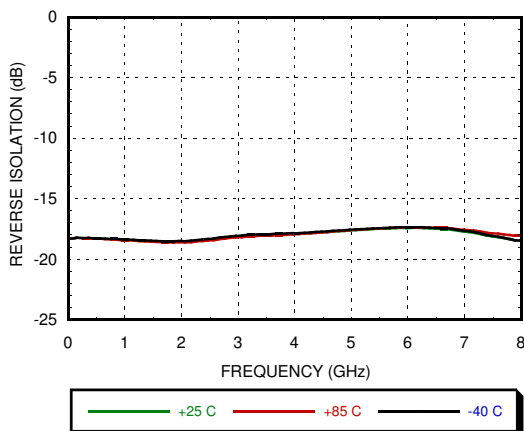

Noise Figure vs. Temperature

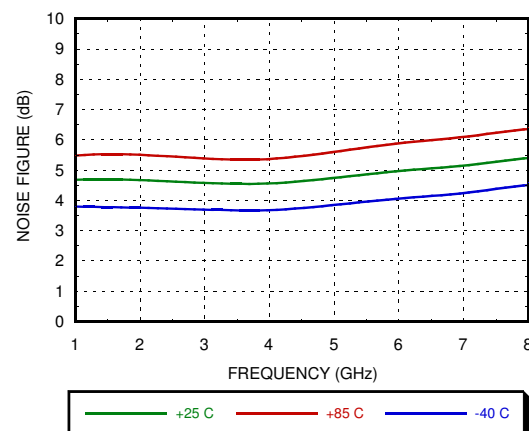

**InGaP HBT GAIN BLOCK
MMIC AMPLIFIER, DC - 6 GHz**

P1dB vs. Temperature

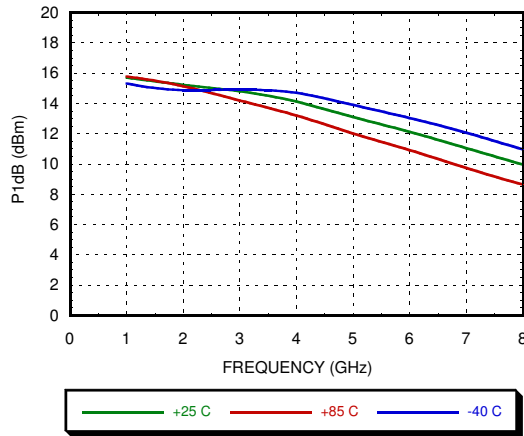

Psat vs. Temperature

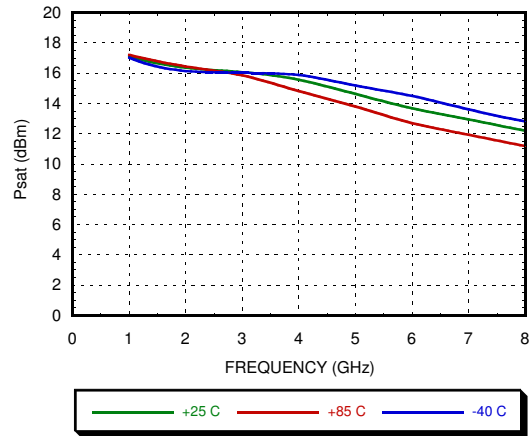

Power Compression @ 1 GHz

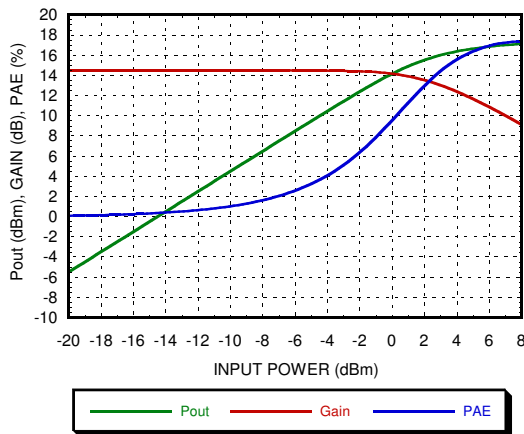

Power Compression @ 6 GHz

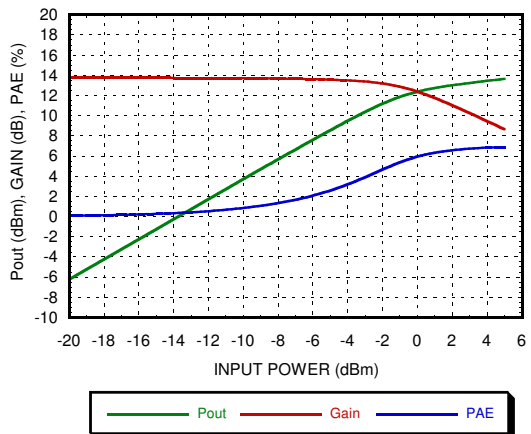

Output IP3 vs. Temperature

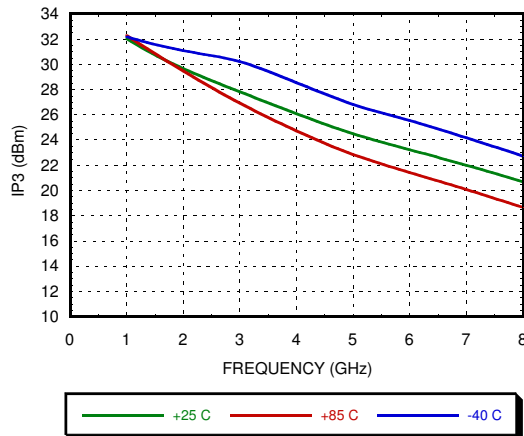

Gain, Power, Output IP3 & Supply Current vs. Supply Voltage @ 1 GHz

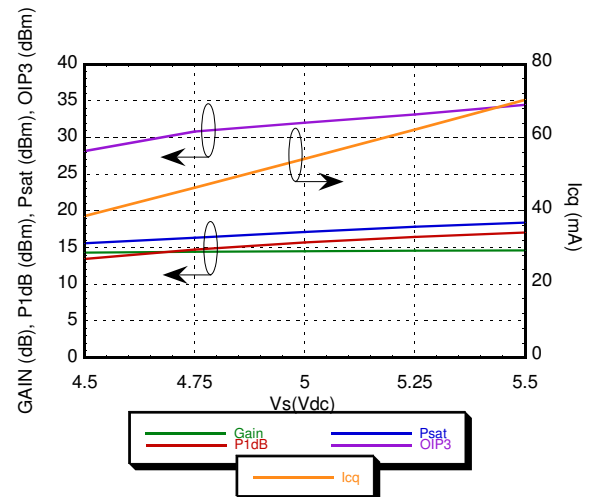

**InGaP HBT GAIN BLOCK
MMIC AMPLIFIER, DC - 6 GHz**

**Additive Phase Noise Vs Offset Frequency,
RF Frequency = 2 GHz,
RF Input Power = 1 dBm (P1dB)**

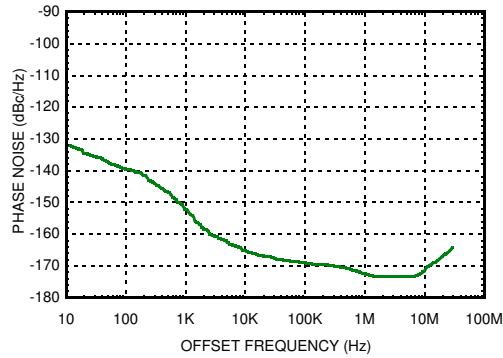

InGaP HBT GAIN BLOCK MMIC AMPLIFIER, DC - 6 GHz

Absolute Maximum Ratings

Collector Bias Voltage (Vcc)	+7V
RF Input Power (RFIN)(Vs = +5V)	+10 dBm
Junction Temperature	150 °C
Continuous P _{diss} (T = 85 °C) (derate 5.21 mW/°C above 85 °C)	0.339 W
Thermal Resistance (junction to ground paddle)	192 °C/W
Storage Temperature	-65 to +150 °C
Operating Temperature	-40 to +85 °C
ESD Sensitivity (HBM)	Class 1A, Passed 250V



ELECTROSTATIC SENSITIVE DEVICE
OBSERVE HANDLING PRECAUTIONS

Outline Drawing

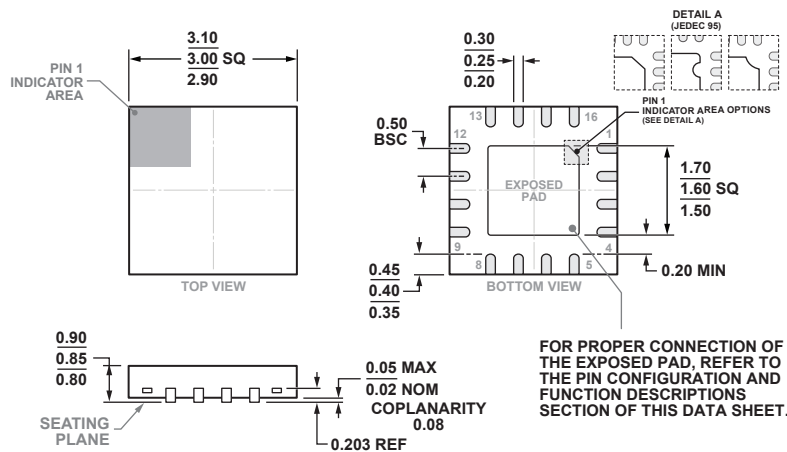

COMPLIANT TO JEDEC STANDARDS MO-220-VEED-4

16-Lead Lead Frame Chip Scale Package [LFCSP]
3 mm x 3 mm Body and 0.85 mm Package Height
(CP-16-50)

Dimensions shown in millimeters

Package Information

Part Number	Package Body Material	Lead Finish	MSL Rating	Package Marking ^[3]
HMC311LP3	Low Stress Injection Molded Plastic	Sn/Pb Solder	MSL1 ^[1]	311 XXXX
HMC311LP3E	RoHS-compliant Low Stress Injection Molded Plastic	100% matte Sn	MSL1 ^[2]	311 XXXX

[1] Max peak reflow temperature of 235 °C

[2] Max peak reflow temperature of 260 °C

[3] 4-Digit lot number XXXX

InGaP HBT GAIN BLOCK MMIC AMPLIFIER, DC - 6 GHz

Pin Descriptions

Pin Number	Function	Description	Interface Schematic
1, 2, 4 - 9, 11 - 16	N/C	This pin may be connected to RF ground.	
3	RFIN	This pin is DC coupled. An off chip DC blocking capacitor is required.	
10	RFOUT	RF output and DC Bias for the output stage.	
	GND	Package bottom must be connected to RF/DC ground.	

Application Circuit

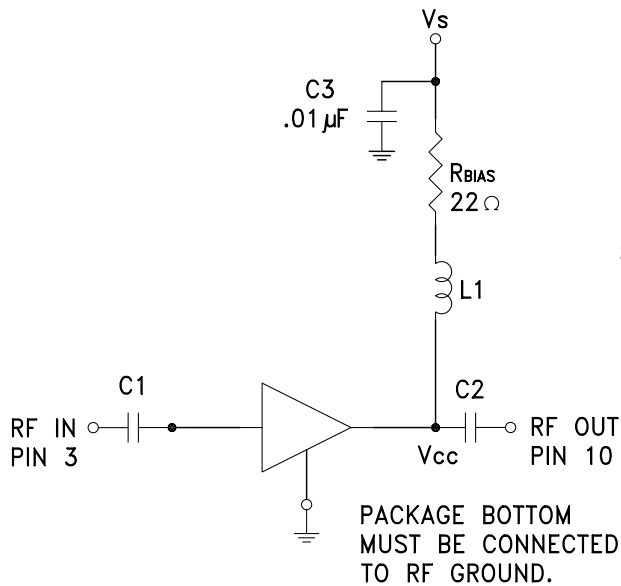

Note:

1. Select Rbias to achieve Icq using equation below, Rbias ≥ 22 Ohm.
2. External blocking capacitors are required on RFIN and RFOUT.

$$I_{cq} = \frac{V_s - 3.8}{R_{bias}}$$

Recommended Component Values

Component	Frequency (MHz)							
	50	900	1900	2200	2400	3500	5200	5800
L1	270 nH	56 nH	18 nH	18 nH	15 nH	8.2 nH	3.3 nH	3.3 nH
C1, C2	0.01 μF	100 pF	100 pF	100 pF	100 pF	100 pF	100 pF	100 pF

**InGaP HBT GAIN BLOCK
MMIC AMPLIFIER, DC - 6 GHz**

Evaluation PCB

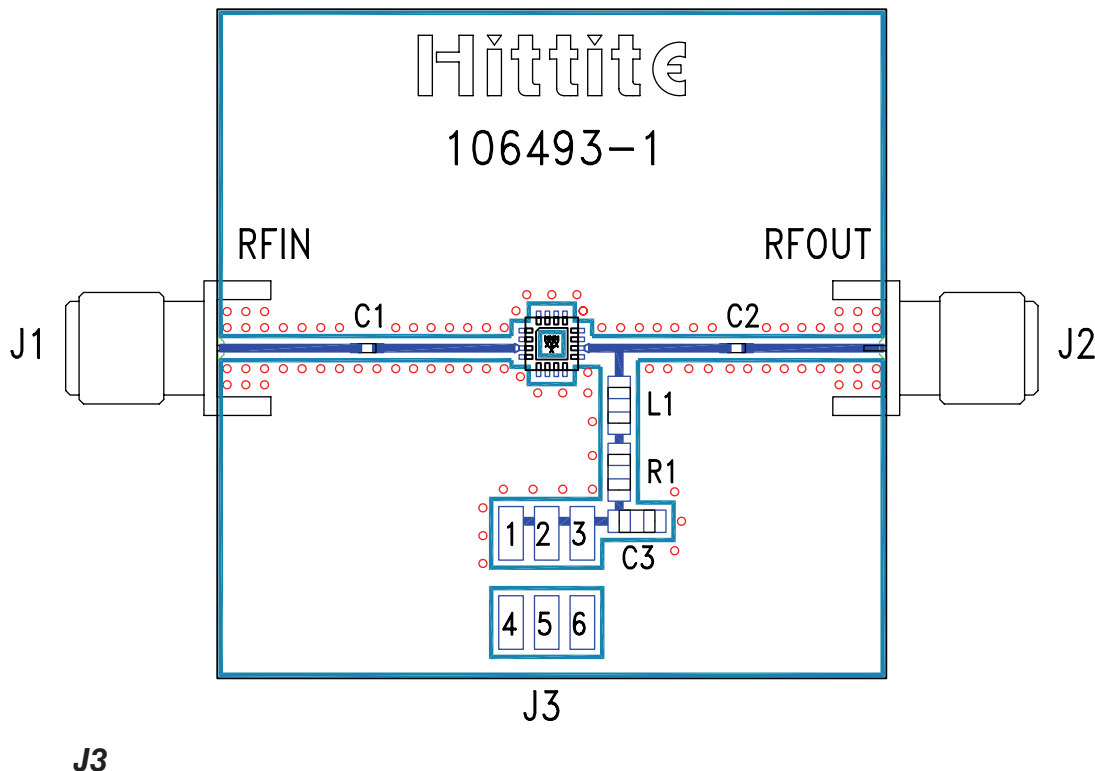

Pin Number	Description
1, 2, 3	Vs
4, 5, 6	GND

List of Materials for Evaluation PCB 106789 [1]

Item	Description
J1 - J2	PC Mount SMA Connector
J3	2 mm DC Header
C1, C2	Capacitor, 0402 Pkg.
C3	10,000 pF Capacitor, 0805 Pkg.
R1	22 Ohm Resistor, 0805 Pkg.
L1	Inductor, 22 nH 0805 Pkg.
U1	HMC311LP3 / HMC311LP3E
PCB [2]	106493 Evaluation PCB

[1] Reference this number when ordering complete evaluation PCB

[2] Circuit Board Material: Rogers 4350

The circuit board used in the final application should use RF circuit design techniques. Signal lines should have 50 Ohm impedance while the package ground leads and exposed paddle should be connected directly to the ground plane similar to that shown. A sufficient number of via holes should be used to connect the top and bottom ground planes. The evaluation board should be mounted to an appropriate heat sink. The evaluation circuit board shown is available from Analog Devices upon request.

***InGaP HBT GAIN BLOCK
MMIC AMPLIFIER, DC - 6 GHz*****Notes**



**Стандарт
Электрон
Связь**

Мы молодая и активно развивающаяся компания в области поставок электронных компонентов. Мы поставляем электронные компоненты отечественного и импортного производства напрямую от производителей и с крупнейших складов мира.

Благодаря сотрудничеству с мировыми поставщиками мы осуществляем комплексные и плановые поставки широчайшего спектра электронных компонентов.

Собственная эффективная логистика и склад в обеспечивает надежную поставку продукции в точно указанные сроки по всей России.

Мы осуществляем техническую поддержку нашим клиентам и предпродажную проверку качества продукции. На все поставляемые продукты мы предоставляем гарантию .

Осуществляем поставки продукции под контролем ВП МО РФ на предприятия военно-промышленного комплекса России , а также работаем в рамках 275 ФЗ с открытием отдельных счетов в уполномоченном банке. Система менеджмента качества компании соответствует требованиям ГОСТ ISO 9001.

Минимальные сроки поставки, гибкие цены, неограниченный ассортимент и индивидуальный подход к клиентам являются основой для выстраивания долгосрочного и эффективного сотрудничества с предприятиями радиоэлектронной промышленности, предприятиями ВПК и научно-исследовательскими институтами России.

С нами вы становитесь еще успешнее!

Наши контакты:

Телефон: +7 812 627 14 35

Электронная почта: sales@st-electron.ru

Адрес: 198099, Санкт-Петербург,
Промышленная ул, дом № 19, литера Н,
помещение 100-Н Офис 331