

MAX17600–MAX17605

4A Sink/Source Current, 12ns, Dual MOSFET Drivers

General Description

The MAX17600–MAX17605 devices are high-speed MOSFET drivers capable of sinking /sourcing 4A peak currents. The devices have various inverting and non-inverting part options that provide greater flexibility in controlling the MOSFET. The devices have internal logic circuitry that prevents shoot-through during output-state changes. The logic inputs are protected against voltage spikes up to +14V, regardless of V_{DD} voltage. Propagation delay time is minimized and matched between the dual channels. The devices have very fast switching time, combined with short propagation delays (12ns typ), making them ideal for high-frequency circuits. The devices operate from a +4V to +14V single power supply and typically consume 1mA of supply current. The MAX17600/MAX17601 have standard TTL input logic levels, while the MAX17603 /MAX17604/MAX17605 have CMOS-like high-noise margin (HNM) input logic levels. The MAX17600/MAX17603 are dual inverting input drivers, the MAX17601/MAX17604 are dual noninverting input drivers, and the MAX17602/MAX17605 devices have one noninverting and one inverting input. These devices are provided with enable pins (ENA, ENB) for better control of driver operation.

These devices are available in 8-pin (3mm x 3mm) TDFN, 8-pin (3mm x 5mm) μ MAX®, and 8-pin SO packages and operate over the -40°C to +125°C temperature range.

Applications

- Power MOSFET Switching
- Switch-Mode Power Supplies
- DC-DC Converters
- Motor Control
- Power-Supply Modules

Ordering Information appears at end of data sheet.

Features

- Dual Drivers with Enable Inputs
- +4V to +14V Single Power-Supply Range
- 4A Peak Sink /Source Current
- Inputs Rated to +14V, Regardless of V_{DD} Voltage
- Low 12ns Propagation Delay
- 6ns Typical Rise and 5ns Typical Fall Times with 1nF Load
- Matched Delays Between Channels
- Parallel Operation of Dual Outputs for Larger Driver Output Current
- TTL or HNM Logic-Level Inputs with Hysteresis for Noise Immunity
- Low Input Capacitance: 10pF (typ)
- Thermal Shutdown Protection
- TDFN, μ MAX, and SO Package Options
- -40°C to +125°C Operating Temperature Range

Typical Operating Circuit

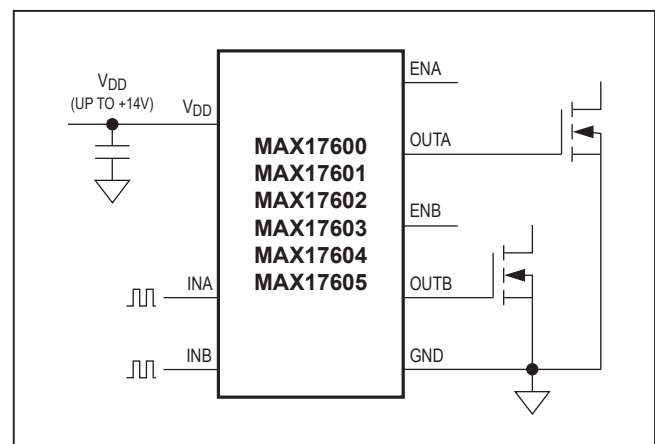

μ MAX is a registered trademark of Maxim Integrated Products, Inc.

Absolute Maximum Ratings

V_{DD}, INA, INB, ENA, ENB to GND-0.3V to +16V
 OUTA, OUTB to GND.....-0.3V to +16V
 Junction Operating Temperature Range -40°C to +125°C
 Continuous Power Dissipation (T_A = +70°C)
 8-Pin TDFN (derate 23.8mW/°C above +70°C) 1904mW
 8-Pin SO (derate 74mW/°C above +70°C)..... 588.2mW*
 8-Pin μMAX (derate 12.9mW/°C above +70°C)..... 1030.9mW

Operating Temperature Range..... -40°C to +125°C
 Junction Temperature..... +150°C
 Storage Temperature Range -65°C to +150°C
 Lead Temperature (soldering, 10s) +300°C
 Soldering Temperature (reflow) +240°C

*As per JEDEC 51 standard.

Stresses beyond those listed under "Absolute Maximum Ratings" may cause permanent damage to the device. These are stress ratings only, and functional operation of the device at these or any other conditions beyond those indicated in the operational sections of the specifications is not implied. Exposure to absolute maximum rating conditions for extended periods may affect device reliability.

Package Information

| | |
|---|-------------------------|
| PACKAGE TYPE: 8 TDFN | |
| Package Code | T833+2 |
| Outline Number | 21-0137 |
| Land Pattern Number | 90-0059 |
| THERMAL RESISTANCE, FOUR-LAYER BOARD | |
| Junction to Ambient (θ _{JA}) | 42°C/W |
| Junction to Case (θ _{JC}) | 8°C/W |

| | |
|---|-------------------------|
| PACKAGE TYPE: 8 SO | |
| Package Code | S8+2 |
| Outline Number | 21-0041 |
| Land Pattern Number | 90-0096 |
| THERMAL RESISTANCE, FOUR-LAYER BOARD | |
| Junction to Ambient (θ _{JA}) | 136°C/W |
| Junction to Case (θ _{JC}) | 38°C/W |

| | |
|---|-------------------------|
| PACKAGE TYPE: 8 μMAX | |
| Package Code | U8E+2 |
| Outline Number | 21-0107 |
| Land Pattern Number | 90-0145 |
| THERMAL RESISTANCE, FOUR-LAYER BOARD | |
| Junction to Ambient (θ _{JA}) | 77.6°C/W |
| Junction to Case (θ _{JC}) | 5°C/W |

For the latest package outline information and land patterns (footprints), go to www.maximintegrated.com/packages. Note that a "+", "#", or "-" in the package code indicates RoHS status only. Package drawings may show a different suffix character, but the drawing pertains to the package regardless of RoHS status.

Package thermal resistances were obtained using the method described in JEDEC specification JESD51-7, using a four-layer board. For detailed information on package thermal considerations, refer to www.maximintegrated.com/thermal-tutorial.

Electrical Characteristics

($V_{DD} = 12V$, $C_L = 0F$, at $T_A = -40^{\circ}C$ to $+125^{\circ}C$, unless otherwise noted. Typical values are specified at $T_A = +25^{\circ}C$. Parameters specified at $V_{DD} = 4V$ apply to the TTL versions only.) (Note 1)

| PARAMETER | SYMBOL | CONDITIONS | MIN | TYP | MAX | UNITS |
|--|------------|---|-----|-------|------|----------|
| POWER SUPPLY (V_{DD}) | | | | | | |
| V_{DD} Operating Range | V_{DD} | TTL versions | 4 | | 14 | V |
| | | HNM versions | 6 | | 14 | |
| V_{DD} Undervoltage Lockout | UVLO | V_{DD} rising | 3 | 3.5 | 3.85 | V |
| V_{DD} UVLO Hysteresis | | | | 200 | | mV |
| V_{DD} UVLO to OUT_{-} Delay | | V_{DD} rising | | 120 | | μs |
| V_{DD} Supply Current | IDD_Q | Not switching, $V_{DD} = 14V$ (Note 2) | | 1 | 2 | mA |
| | IDD_SW | $V_{DD} = 4.5V$, $C_L = 1nF$, both channels switching at 1MHz | | 12 | 18 | |
| DRIVER OUTPUT (SOURCE) (OUT_A, OUT_B) | | | | | | |
| Peak Output Current (Sourcing) | I_{PK-P} | $V_{DD} = 14V$, $C_L = 10nF$ (Note 2) | | 4 | | A |
| Driver Output Resistance Pulling Up (Note 3) | R_{ON-P} | $V_{DD} = 14V$, $I_{OUT_{-}} = 100mA$ | | 0.88 | 1.85 | Ω |
| | | $V_{DD} = 4V$, $I_{OUT_{-}} = 100mA$ | | 0.91 | 1.95 | |
| DRIVER OUTPUT (SINK) (OUT_A, OUT_B) | | | | | | |
| Peak Output Current (Sinking) | I_{PK-N} | $V_{DD} = 14V$, $C_L = 10nF$ (Note 2) | | 4 | | A |
| Driver Output Resistance Pulling Down (Note 3) | R_{ON-N} | $V_{DD} = 14V$, $I_{OUT_{-}} = -100mA$ | | 0.5 | 0.95 | Ω |
| | | $V_{DD} = 4V$, $I_{OUT_{-}} = -100mA$ | | 0.52 | 1 | |
| LOGIC INPUT (INA, INB) | | | | | | |
| $V_{IN_{-}}$ Logic-High Input Voltage | V_{IH} | MAX17600/1/2 | | 2.1 | | V |
| | | MAX17603/4/5 | | 4.25 | | |
| $V_{IN_{-}}$ Logic-Low Input Voltage | V_{IL} | MAX17600/1/2 | | | 0.8 | V |
| | | MAX17603/4/5 | | | 2.0 | |
| Logic Input Hysteresis | V_{HYS} | MAX17600/1/2 | | 0.34 | | V |
| | | MAX17603/4/5 | | 0.9 | | |
| Logic Input Leakage Current | I_{LKG} | $V_{INA} = V_{INB} = 0V$ or V_{DD} (MAX17600/1/2) | -1 | +0.02 | +1 | μA |
| Logic Input Bias Current | I_{BIAS} | $V_{INA} = V_{INB} = 0V$ or V_{DD} (MAX17603/4/5) | | 10 | | μA |
| Logic Input Capacitance | C_{IN} | (Note 2) | | 10 | | pF |

Electrical Characteristics (continued)

($V_{DD} = 12V$, $C_L = 0F$, at $T_A = -40^\circ C$ to $+125^\circ C$, unless otherwise noted. Typical values are specified at $T_A = +25^\circ C$. Parameters specified at $V_{DD} = 4V$ apply to the TTL versions only.) (Note 1)

| PARAMETER | SYMBOL | CONDITIONS | MIN | TYP | MAX | UNITS |
|--|-------------|-------------------------------|------|-----|-----|------------|
| ENABLE (ENA, ENB) | | | | | | |
| V_{EN_H} High Level Voltage | | MAX17600/1/2 | 2.1 | | | V |
| | | MAX17603/4/5 | 4.25 | | | |
| V_{EN_L} Low Level Voltage | | MAX17600/1/2 | 0.8 | | | V |
| | | MAX17603/4/5 | 2.0 | | | |
| Enable Hysteresis | EN_HYS | MAX17600/1/2 | 0.34 | | | V |
| | | MAX17603/4/5 | 0.9 | | | |
| Enable Pullup Resistor to V_{DD} | R_{pu} | MAX17600/1/2 | 50 | 100 | 200 | k Ω |
| | | MAX17603/4/5 | 100 | 200 | 400 | |
| Propagation Delay from EN_ to OUT_ (Note 2) | t_{pd} | EN_ rising | 7 | | | ns |
| | | EN_ falling | 7 | | | |
| SWITCHING CHARACTERISTICS ($V_{DD} = 14V$) (Note 2) | | | | | | |
| OUT_ Rise Time | t_R | $C_L = 1nF$ | 6 | | | ns |
| | | $C_L = 4.7nF$ | 20 | | | |
| | | $C_L = 10nF$ | 40 | | | |
| OUT_ Fall Time | t_F | $C_L = 1nF$ | 6 | | | ns |
| | | $C_L = 4.7nF$ | 16 | | | |
| | | $C_L = 10nF$ | 25 | | | |
| Turn-On Delay Time | t_{D-ON} | $C_L = 1nF$ | 12 | | | ns |
| Turn-Off Delay Time | t_{D-OFF} | $C_L = 1nF$ | 12 | | | ns |
| SWITCHING CHARACTERISTICS ($V_{DD} = 4.5V$) (Note 2) | | | | | | |
| OUT_ Rise Time | t_R | $C_L = 1nF$ | 5 | | | ns |
| | | $C_L = 4.7nF$ | 15 | | | |
| | | $C_L = 10nF$ | 28 | | | |
| OUT_ Fall Time | t_F | $C_L = 1nF$ | 5 | | | ns |
| | | $C_L = 4.7nF$ | 10 | | | |
| | | $C_L = 10nF$ | 18 | | | |
| Turn-On Delay Time | t_{D-ON} | $C_L = 1nF$ | 12 | | | ns |
| Turn-Off Delay Time | t_{D-OFF} | $C_L = 1nF$ | 12 | | | ns |
| MATCHING CHARACTERISTICS (Note 2) | | | | | | |
| Matching Propagation Delays Between Channel A and Channel B | | $V_{DD} = 14V$, $C_L = 10nF$ | 8 | | | ns |

Note 1: All devices are production tested at $T_A = +25^\circ C$. Limits over temperature are guaranteed by design.

Note 2: Design guaranteed by bench characterization. Limits are not production tested.

Note 3: For SOIC, μ MAX package options, these are only Typ parameters.

Typical Operating Characteristics

($C_L = 1\text{nF}$, $T_A = +25^\circ\text{C}$, unless otherwise noted.)

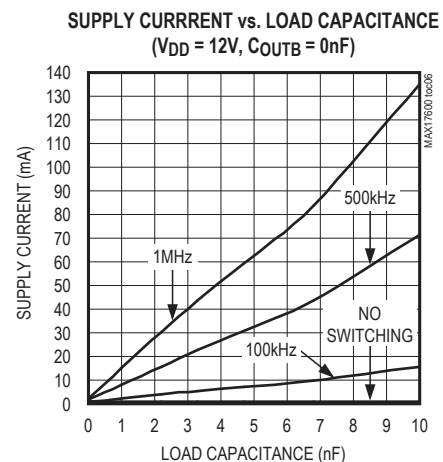
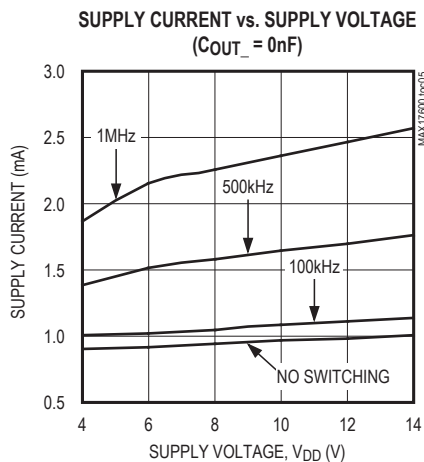
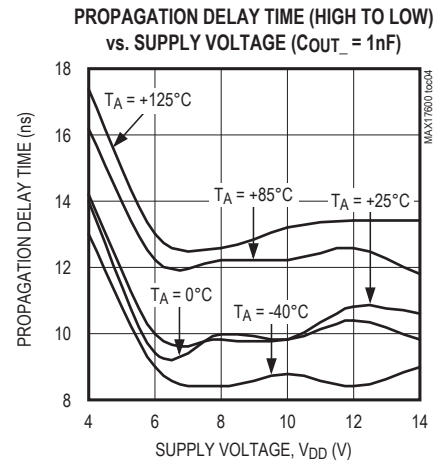
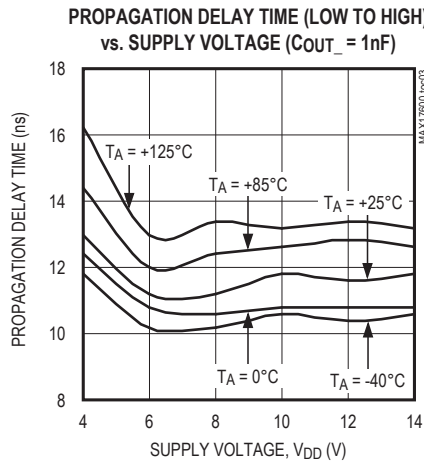
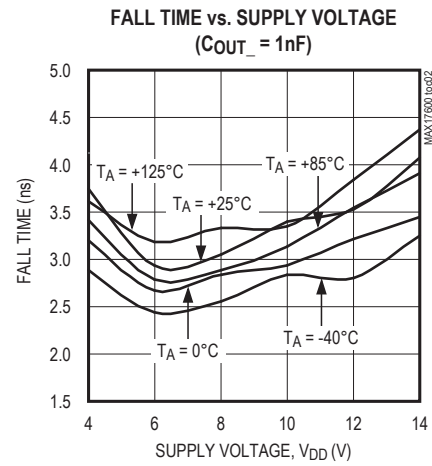
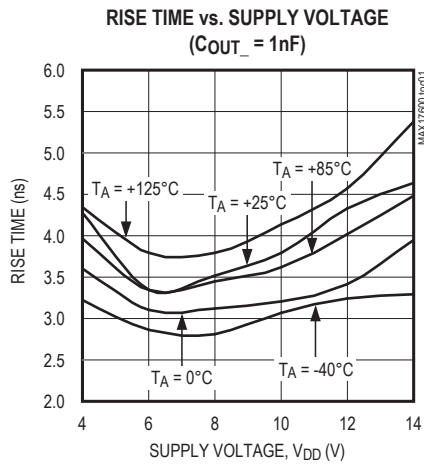

Typical Operating Characteristics (continued)

($C_L = 1\text{nF}$, $T_A = +25^\circ\text{C}$, unless otherwise noted.)

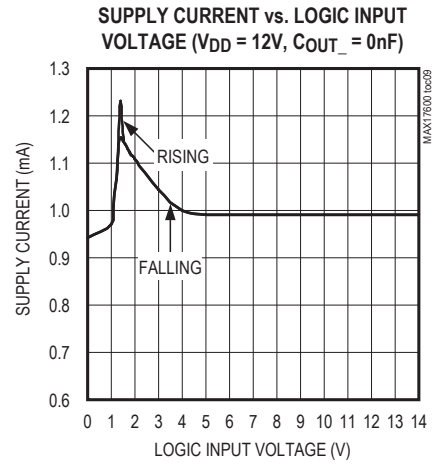
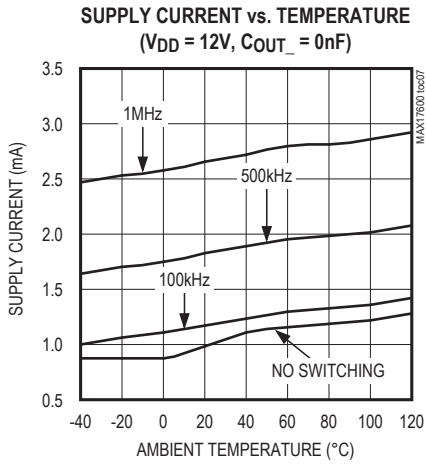

Typical Operating Characteristics (continued)

($C_L = 1\text{nF}$, $T_A = +25^\circ\text{C}$, unless otherwise noted.)

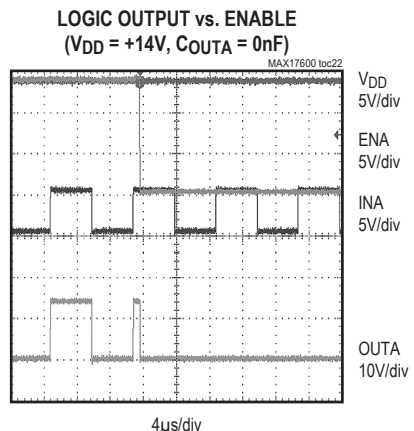
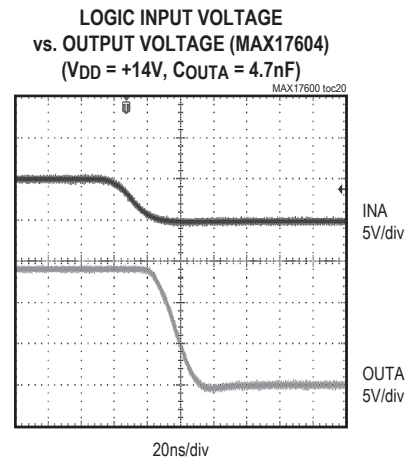
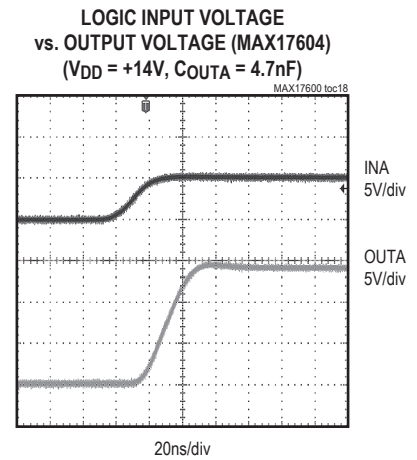

Pin Configurations



Pin Description

| PIN | NAME | FUNCTION |
|-----|-----------------|--|
| 1 | ENA | Enable Input for Driver A. Internally pulled to V _{DD} through a 100kΩ resistor. Leave unconnected for always-on operation. Connect to GND for disabling the corresponding channel. |
| 2 | INA | Logic Input for Channel A |
| 3 | GND | Ground |
| 4 | INB | Logic Input for Channel B |
| 5 | OUTB | Channel B Driver Output. Sources and sinks current for channel B to turn the external MOSFET at OUTB on or off. |
| 6 | V _{DD} | Power-Supply Input. Bypass to GND with one or more low-ESR 0.1μF ceramic capacitors. |
| 7 | OUTA | Channel A Driver Output. Sources and sinks current for channel A to turn the external MOSFET at OUTA on or off. |
| 8 | ENB | Enable Input for Driver B. Internally pulled to V _{DD} through a 100kΩ resistor. Leave unconnected for always-on operation. Connect to GND for disabling the corresponding channel. |
| — | EP | Exposed Pad (TDFN Only). Internally connected to GND. Do not use the EP as the only ground connection. |

Functional Diagram



Figure 1. Timing Diagram for the MAX17601/MAX17604



Figure 2. Timing Diagram for the MAX17602/MAX17605



Figure 3. Timing Diagram for the MAX17600/MAX17603



Figure 4. Test Circuit for the Timing Diagrams

Detailed Description

The MAX17600–MAX17605 are high-speed MOSFET drivers capable of sinking/sourcing 4A peak currents. The devices have various inverting and noninverting part options that provide greater flexibility in controlling the MOSFET. The devices have internal logic circuitry that prevents shoot-through during output-state changes. The logic inputs are protected against voltage spikes up to +16V, regardless of V_{DD} voltage. Propagation delay time is minimized and matched between the dual channels. The devices have very fast switching time, combined with short propagation delays (12ns typ), making them ideal for high-frequency circuits. The devices operate from a +4V to +14V single power supply and typically consume 1mA of supply current. The MAX17600/MAX17601/MAX17602 have standard TTL input logic levels, while the MAX17603/MAX17604/MAX17605 have CMOS-like high-noise margin (HNM) input logic levels. The MAX17600/MAX17603 are dual inverting input drivers, the MAX17601/MAX17604 are dual noninverting input drivers, and the MAX17602/MAX17605 have one noninverting and one inverting input. These devices are provided with enable pins (ENA and ENB) for better control of driver operation.

Logic Inputs

The MAX17600/MAX17601/MAX17602 have standard TTL input logic levels, while the MAX17603/MAX17604/MAX17605 have CMOS-like HNM input logic levels (see the [Electrical Characteristics](#) table). [Table 1](#) gives the truth table for various part options.

Table 1. Truth Table

| ENABLE INPUTS | | LOGIC INPUTS | | DUAL NONINVERTING DRIVER | | DUAL INVERTING DRIVER | | ONE INVERTING AND ONE NONINVERTING DRIVER | |
|---------------|-----|--------------|-----|--------------------------|------|-----------------------|------|---|------|
| ENA | ENB | INA | INB | OUTA | OUTB | OUTA | OUTB | OUTA | OUTB |
| H | H | H | H | H | H | L | L | L | H |
| H | H | H | L | H | L | L | H | L | L |
| H | H | L | H | L | H | H | L | H | H |
| H | H | L | L | L | L | H | H | H | L |
| L | L | X | X | L | L | L | L | L | L |

L = Logic-low, H = Logic-high.

Undervoltage Lockout (UVLO)

When V_{DD} is below the UVLO threshold, the output stage n-channel device is on and the p-channel is off, independent of the state of the inputs. This holds the outputs low. The UVLO is typically 3.6V with 200mV typical hysteresis to avoid chattering. A typical falling delay of 2 μ s makes the UVLO immune to narrow negative transients in noisy environments.

Driver Outputs

The devices feature 4A peak sourcing/sinking capabilities to provide fast rise and fall times of the MOSFET gate. Add a resistor in series with OUT_{-} to slow the corresponding rise/fall time of the MOSFET gate.

Applications Information

Supply Bypassing, Device Grounding, and Placement

Ample supply bypassing and device grounding are extremely important because when large external capacitive loads are driven, the peak current at the V_{DD} pin can approach 4A, while at the GND pin, the peak current can approach 4A. V_{DD} drops and ground shifts are forms of negative feedback for inverters and, if excessive, can cause multiple switching when the inverting input is used and the input slew rate is low. The device driving the input should be referenced to the devices' GND pin, especially when the inverting input is used. Ground shifts due to insufficient device grounding can disturb other circuits sharing the same AC ground return path. Any series inductance in the V_{DD} , OUT_{-} , and/or GND paths can cause oscillations due to the very high di/dt that results when the devices are switched with any capacitive load. A 2.2 μ F or larger value ceramic capacitor is recommended, bypassing V_{DD} to GND and placed as close as possible to the pins. When driving very large loads (e.g., 10nF) at minimum rise time, 10 μ F or more of parallel storage capacitance is recommended. A ground plane is highly recommended to minimize ground return resistance and series inductance. Care should be taken to place the devices as close as possible to the external MOSFET being driven to further minimize board inductance and AC path resistance.

Power Dissipation

Power dissipation of the devices consists of three components, caused by the quiescent current, capacitive charge and discharge of internal nodes, and the output current (either capacitive or resistive load). The sum of these components must be kept below the maximum power-dissipation limit.

The quiescent current is 1mA typical. The current required to charge and discharge the internal nodes is frequency dependent (see the [Typical Operating Characteristics](#)). The devices' power dissipation when driving a ground referenced resistive load is:

$$P = D \times R_{ON} (MAX) \times I_{LOAD}^2 \text{ per channel}$$

where D is the fraction of the period the devices' output pulls high, $R_{ON} (MAX)$ is the maximum pullup on-resistance of the device with the output high, and I_{LOAD} is the output load current of the devices.

For capacitive loads, the power dissipation is:

$$P = C_{LOAD} \times (V_{DD})^2 \times \text{FREQ per channel}$$

where C_{LOAD} is the capacitive load, V_{DD} is the supply voltage, and FREQ is the switching frequency.

Layout Information

The devices' MOSFET drivers source and sink large currents to create very fast rise and fall edges at the gate of the switching MOSFET. The high di/dt can cause unacceptable ringing if the trace lengths and impedances are not well controlled. The following PCB layout guidelines are recommended when designing with the devices:

- Place at least one 2.2 μ F decoupling ceramic capacitor from V_{DD} to GND as close as possible to the IC. At least one storage capacitor of 10 μ F (min) should be located on the PCB with a low-resistance path to the V_{DD} pin of the devices. There are two AC current loops formed between the IC and the gate of the MOSFET being driven. The MOSFET looks like a large capacitance from gate to source when the gate is being pulled low. The active current loop is from OUT_{-} of the devices to the MOSFET gate to the MOSFET source and to GND of the devices. When the gate of the MOSFET is being pulled high, the active current loop is from OUT_{-} of the devices to the MOSFET gate to the MOSFET source to the GND terminal of the decoupling capacitor to the V_{DD} terminal of the decoupling capacitor and to the V_{DD} terminal of the devices. While the charging current loop is important, the discharging current loop is also critical. It is important to minimize the physical distance and the impedance in these AC current paths.
- In a multilayer PCB, the component surface layer surrounding the devices should consist of a ground plane containing the discharging and charging current loops.

Ordering Information/Selector Guide

| PART | PIN-PACKAGE | CONFIGURATION | LOGIC LEVELS | TOP MARK |
|----------------------|------------------------|------------------------|--------------|----------|
| MAX17600 ATA+ | 8 TDFN-EP* (3mm x 3mm) | Dual/Inverting | TTL | +BOJ |
| MAX17600ASA+ | 8 SO | Dual/Inverting | TTL | + |
| MAX17600AUA+ | 8 μ MAX-EP* | Dual/Inverting | TTL | +AACI |
| MAX17601 ATA+ | 8 TDFN-EP* (3mm x 3mm) | Dual/Noninverting | TTL | +BOK |
| MAX17601ASA+ | 8 SO | Dual/Noninverting | TTL | + |
| MAX17601AUA+ | 8 μ MAX-EP* | Dual/Noninverting | TTL | +AACJ |
| MAX17602 ATA+ | 8 TDFN-EP* (3mm x 3mm) | Inverting/Noninverting | TTL | +BOL |
| MAX17602ASA+ | 8 SO | Inverting/Noninverting | TTL | + |
| MAX17602AUA+ | 8 μ MAX-EP* | Inverting/Noninverting | TTL | +AACK |
| MAX17603 ATA+ | 8 TDFN-EP* (3mm x 3mm) | Dual/Inverting | HNM | +BOM |
| MAX17603ASA+ | 8 SO | Dual/Inverting | HNM | + |
| MAX17603AUA+ | 8 μ MAX-EP* | Dual/Inverting | HNM | +AACL |
| MAX17604 ATA+ | 8 TDFN-EP* (3mm x 3mm) | Dual/Noninverting | HNM | +BON |
| MAX17604ASA+ | 8 SO | Dual/Noninverting | HNM | + |
| MAX17604AUA+ | 8 μ MAX-EP* | Dual/Noninverting | HNM | +AACM |
| MAX17605 ATA+ | 8 TDFN-EP* (3mm x 3mm) | Inverting/Noninverting | HNM | +BOO |
| MAX17605ASA+ | 8 SO | Inverting/Noninverting | HNM | + |
| MAX17605AUA+ | 8 μ MAX-EP* | Inverting/Noninverting | HNM | +AACN |

Note: All devices are specified over the -40°C to $+125^{\circ}\text{C}$ temperature range. Optional 8-pin 2mm x 3mm TDFN package is available. Contact your Maxim sales representative for more information.

+Denotes a lead(Pb)-free/RoHS-compliant package.

*EP = Exposed pad.

Chip Information

PROCESS: BiCMOS

Revision History

| REVISION NUMBER | REVISION DATE | DESCRIPTION | PAGES CHANGED |
|-----------------|---------------|--|---------------|
| 0 | 1/12 | Initial release | — |
| 1 | 5/12 | Added the MAX17600 | 1–12 |
| 2 | 6/17 | Updated <i>Electrical Characteristics</i> table OUT_ Rise Time for Switching Characteristics ($V_{DD} = 14V$ and $V_{DD} = 4.5V$) units from pF to nF. | 3–4 |

For pricing, delivery, and ordering information, please contact Maxim Direct at 1-888-629-4642, or visit Maxim Integrated's website at www.maximintegrated.com.

Maxim Integrated cannot assume responsibility for use of any circuitry other than circuitry entirely embodied in a Maxim Integrated product. No circuit patent licenses are implied. Maxim Integrated reserves the right to change the circuitry and specifications without notice at any time. The parametric values (min and max limits) shown in the Electrical Characteristics table are guaranteed. Other parametric values quoted in this data sheet are provided for guidance.



Стандарт Электрон Связь

Мы молодая и активно развивающаяся компания в области поставок электронных компонентов. Мы поставляем электронные компоненты отечественного и импортного производства напрямую от производителей и с крупнейших складов мира.

Благодаря сотрудничеству с мировыми поставщиками мы осуществляем комплексные и плановые поставки широчайшего спектра электронных компонентов.

Собственная эффективная логистика и склад в обеспечивает надежную поставку продукции в точно указанные сроки по всей России.

Мы осуществляем техническую поддержку нашим клиентам и предпродажную проверку качества продукции. На все поставляемые продукты мы предоставляем гарантию .

Осуществляем поставки продукции под контролем ВП МО РФ на предприятия военно-промышленного комплекса России , а также работаем в рамках 275 ФЗ с открытием отдельных счетов в уполномоченном банке. Система менеджмента качества компании соответствует требованиям ГОСТ ISO 9001.

Минимальные сроки поставки, гибкие цены, неограниченный ассортимент и индивидуальный подход к клиентам являются основой для выстраивания долгосрочного и эффективного сотрудничества с предприятиями радиоэлектронной промышленности, предприятиями ВПК и научно-исследовательскими институтами России.

С нами вы становитесь еще успешнее!

Наши контакты:

Телефон: +7 812 627 14 35

Электронная почта: sales@st-electron.ru

Адрес: 198099, Санкт-Петербург,
Промышленная ул, дом № 19, литера Н,
помещение 100-Н Офис 331