

PZT3906T1

Preferred Device

General Purpose Transistor PNP Silicon

Features

- Pb-Free Package is Available

MAXIMUM RATINGS

| Rating | Symbol | Value | Unit |
|--------------------------------|-----------|-------|------|
| Collector - Emitter Voltage | V_{CEO} | -40 | Vdc |
| Collector - Base Voltage | V_{CBO} | -40 | Vdc |
| Emitter - Base Voltage | V_{EBO} | -5.0 | Vdc |
| Collector Current - Continuous | I_C | -200 | mAdc |

THERMAL CHARACTERISTICS

| Characteristic | Symbol | Max | Unit |
|---|-----------------|----------------|---------------------------|
| Total Device Dissipation (Note 1) $T_A = 25^\circ\text{C}$ | P_D | 1.5 12 | W mW/ $^\circ\text{C}$ |
| Thermal Resistance Junction-to-Ambient (Note 1) | $R_{\theta JA}$ | 83.3 | $^\circ\text{C}/\text{W}$ |
| Thermal Resistance Junction-to-Lead #4 | $R_{\theta JA}$ | 35 | $^\circ\text{C}/\text{W}$ |
| Junction and Storage Temperature Range | T_J, T_{stg} | -55 to +150 | $^\circ\text{C}$ |

Stresses exceeding Maximum Ratings may damage the device. Maximum Ratings are stress ratings only. Functional operation above the Recommended Operating Conditions is not implied. Extended exposure to stresses above the Recommended Operating Conditions may affect device reliability.

1. FR-4 with 1 oz and 713 mm² of copper area.



ON Semiconductor®

<http://onsemi.com>

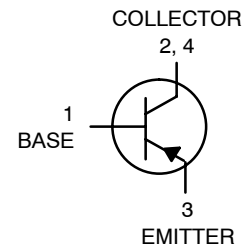

MARKING DIAGRAM

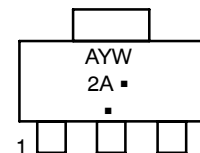

2A = Specific Device Code
A = Assembly Location
Y = Year
W = Work Week
▪ = Pb-Free Package

(Note: Microdot may be in either location)

ORDERING INFORMATION

| Device | Package | Shipping† |
|------------|----------------------|--------------------|
| PZT3906T1 | SOT-223 | 1000 / Tape & Reel |
| PZT3906T1G | SOT-223 (Pb-Free) | 1000 / Tape & Reel |

†For information on tape and reel specifications, including part orientation and tape sizes, please refer to our Tape and Reel Packaging Specifications Brochure, BRD8011/D.

Preferred devices are recommended choices for future use and best overall value.

PZT3906T1

ELECTRICAL CHARACTERISTICS (T_A = 25°C unless otherwise noted)

| Characteristic | Symbol | Min | Max | Unit |
|---|----------------------|------|-----|------------------|
| OFF CHARACTERISTICS (Note 2) | | | | |
| Collector - Emitter Breakdown Voltage (Note 2) (I _C = -1.0 mA _{dc} , I _B = 0) | V _{(BR)CEO} | -40 | - | V _{dc} |
| Collector - Base Breakdown Voltage (I _C = -10 μA _{dc} , I _E = 0) | V _{(BR)CBO} | -40 | - | |
| Emitter - Base Breakdown Voltage (I _E = -10 μA _{dc} , I _C = 0) | V _{(BR)EBO} | -5.0 | - | |
| Base Cutoff Current (V _{CE} = -30 V _{dc} , V _{EB} = -3.0 V _{dc}) | I _{BL} | - | -50 | nA _{dc} |
| Collector Cutoff Current (V _{CE} = -30 V _{dc} , V _{EB} = -3.0 V _{dc}) | I _{CEx} | - | -50 | |

ON CHARACTERISTICS

 (Note 2)

| | | | | |
|---|----------------------|-----------------------------|-------------------------|-----------------|
| DC Current Gain (I _C = -0.1 mA _{dc} , V _{CE} = -1.0 V _{dc}) (I _C = -1.0 mA _{dc} , V _{CE} = -1.0 V _{dc}) (I _C = -10 mA _{dc} , V _{CE} = -1.0 V _{dc}) (I _C = -50 mA _{dc} , V _{CE} = -1.0 V _{dc}) (I _C = -100 mA _{dc} , V _{CE} = -1.0 V _{dc}) | H _{FE} | 60 80 100 60 30 | - - 300 - - | - |
| Collector - Emitter Saturation Voltage (I _C = -10 mA _{dc} , I _B = -1.0 mA _{dc}) (I _C = -50 mA _{dc} , I _B = -5.0 mA _{dc}) | V _{CE(sat)} | - - | -0.25 -0.4 | V _{dc} |
| Base - Emitter Saturation Voltage (I _C = -10 mA _{dc} , I _B = -1.0 mA _{dc}) (I _C = -50 mA _{dc} , I _B = -5.0 mA _{dc}) | V _{BE(sat)} | -0.65 - | -0.85 -0.95 | |

SMALL-SIGNAL CHARACTERISTICS

| | | | | |
|--|------------------|-----|-----|--------------------|
| Current - Gain - Bandwidth Product (I _C = -10 mA _{dc} , V _{CE} = -20 V _{dc} , f = 100 MHz) | f _T | 250 | - | MHz |
| Output Capacitance (V _{CB} = -5.0 V _{dc} , I _E = 0, f = 1.0 MHz) | C _{obo} | - | 4.5 | pF |
| Input Capacitance (V _{EB} = -0.5 V _{dc} , I _C = 0, f = 1.0 MHz) | C _{ibo} | - | 10 | |
| Input Impedance (I _C = -1.0 mA _{dc} , V _{CE} = -10 V _{dc} , f = 1.0 kHz) | h _{ie} | 2.0 | 12 | kΩ |
| Voltage Feedback Ratio (I _C = -1.0 mA _{dc} , V _{CE} = -10 V _{dc} , f = 1.0 kHz) | h _{re} | 0.1 | 10 | X 10 ⁻⁴ |
| Small - Signal Current Gain (I _C = -1.0 mA _{dc} , V _{CE} = -10 V _{dc} , f = 1.0 kHz) | h _{fe} | 100 | 400 | - |
| Output Admittance (I _C = -1.0 mA _{dc} , V _{CE} = -10 V _{dc} , f = 1.0 kHz) | h _{oe} | 3.0 | 60 | μmhos |
| Noise Figure (I _C = -100 μA _{dc} , V _{CE} = -5.0 V _{dc} , R _S = 1.0 kΩ, f = 1.0 kHz) | NF | - | 4.0 | dB |

SWITCHING CHARACTERISTICS

| | | | | | |
|--------------|--|----------------|---|-----|----|
| Delay Time | (V _{CC} = -3.0 V _{dc} , V _{BE} = 0.5 V _{dc} , I _C = -10 mA _{dc} , I _{B1} = -1.0 mA _{dc}) | t _d | - | 35 | ns |
| Rise Time | | t _r | - | 35 | |
| Storage Time | (V _{CC} = -3.0 V _{dc} , I _C = -10 mA _{dc} , I _{B1} = I _{B2} = -1.0 mA _{dc}) | t _s | - | 225 | |
| Fall Time | | t _f | - | 75 | |

2. Pulse Width ≤ 300 μs, Duty Cycle ≤ 2.0%.

PZT3906T1

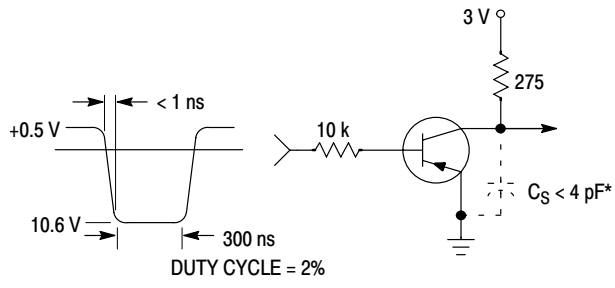

**Figure 1. Delay and Rise Time
Equivalent Test Circuit**

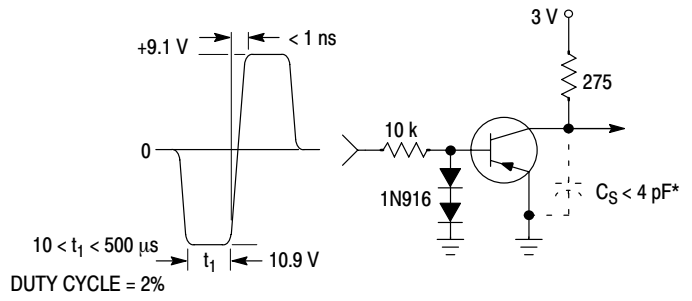

**Figure 2. Storage and Fall Time
Equivalent Test Circuit**

* Total shunt capacitance of test jig and connectors

PZT3906T1

TYPICAL TRANSIENT CHARACTERISTICS

— $T_J = 25^\circ\text{C}$
 - - - $T_J = 125^\circ\text{C}$

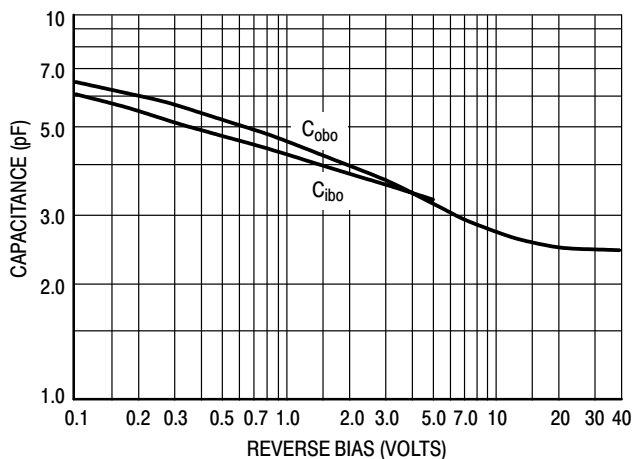

Figure 3. Capacitance

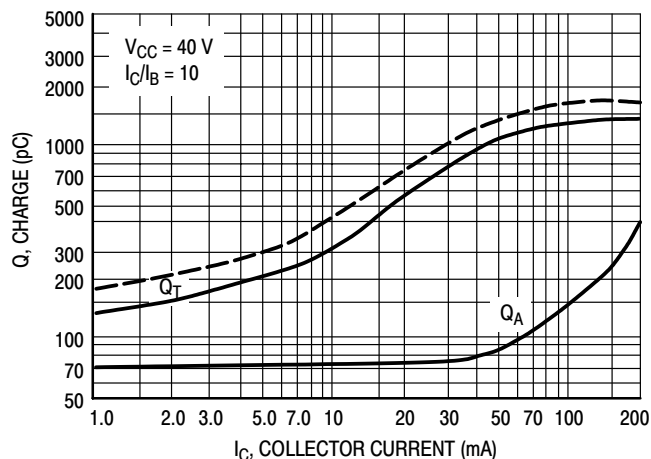

Figure 4. Charge Data

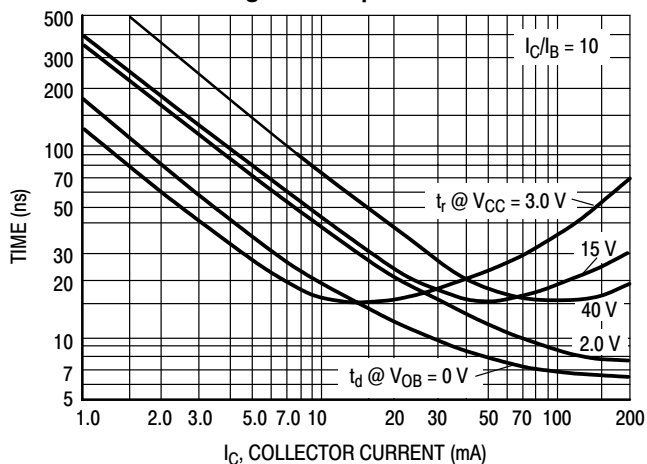

Figure 5. Turn-On Time

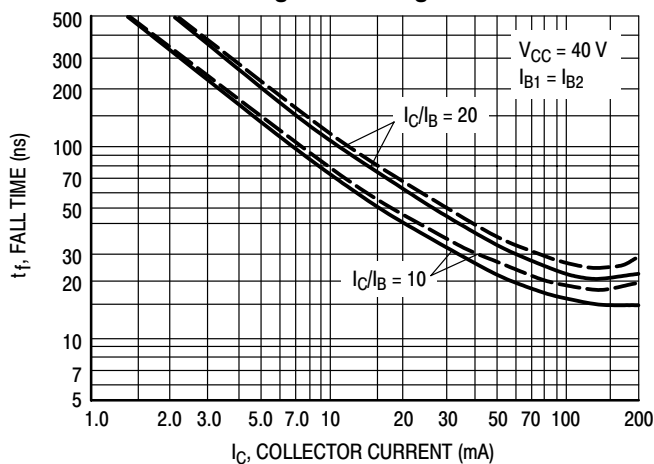

Figure 6. Fall Time

TYPICAL AUDIO SMALL-SIGNAL CHARACTERISTICS NOISE FIGURE VARIATIONS

($V_{CE} = -5.0\text{ Vdc}$, $T_A = 25^\circ\text{C}$, Bandwidth = 1.0 Hz)

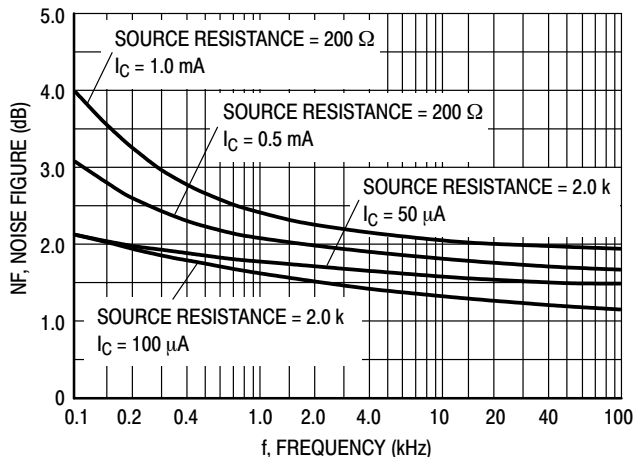

Figure 7.

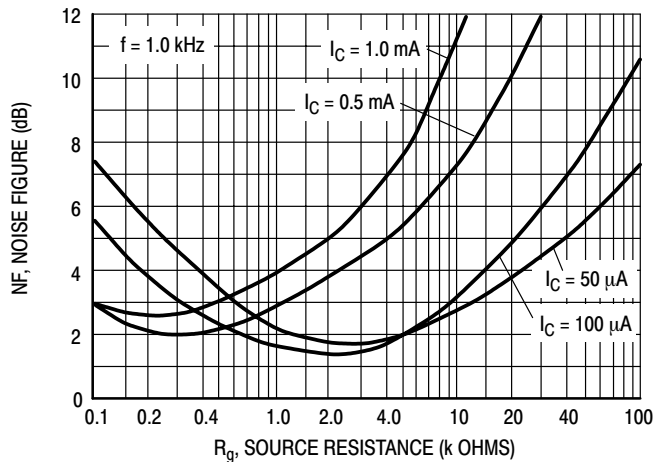

Figure 8.

PZT3906T1

h PARAMETERS

($V_{CE} = -10$ Vdc, $f = 1.0$ kHz, $T_A = 25^\circ\text{C}$)

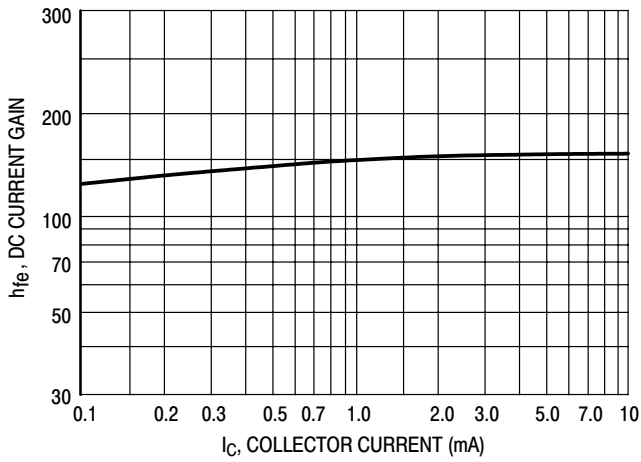

Figure 9. Current Gain

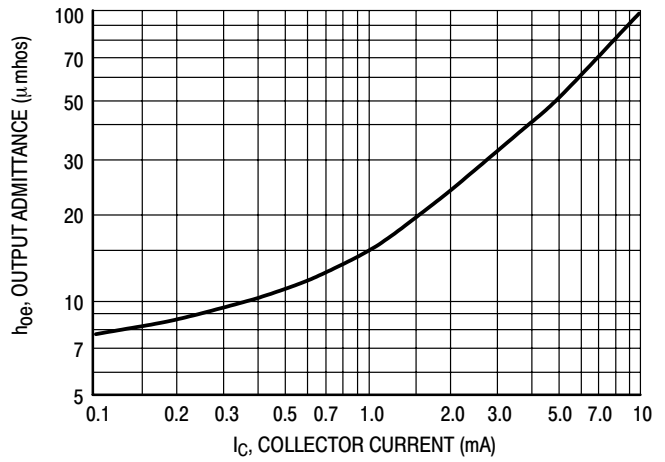

Figure 10. Output Admittance

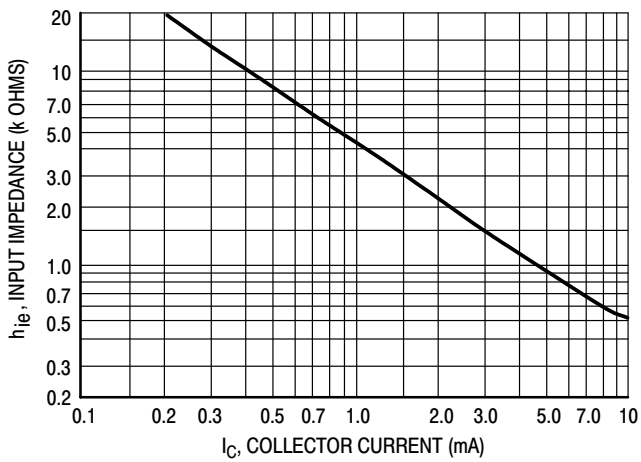

Figure 11. Input Impedance

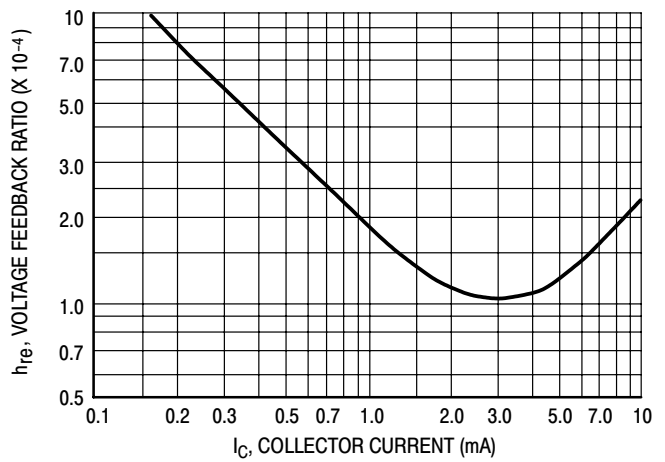

Figure 12. Voltage Feedback Ratio

PZT3906T1

TYPICAL STATIC CHARACTERISTICS

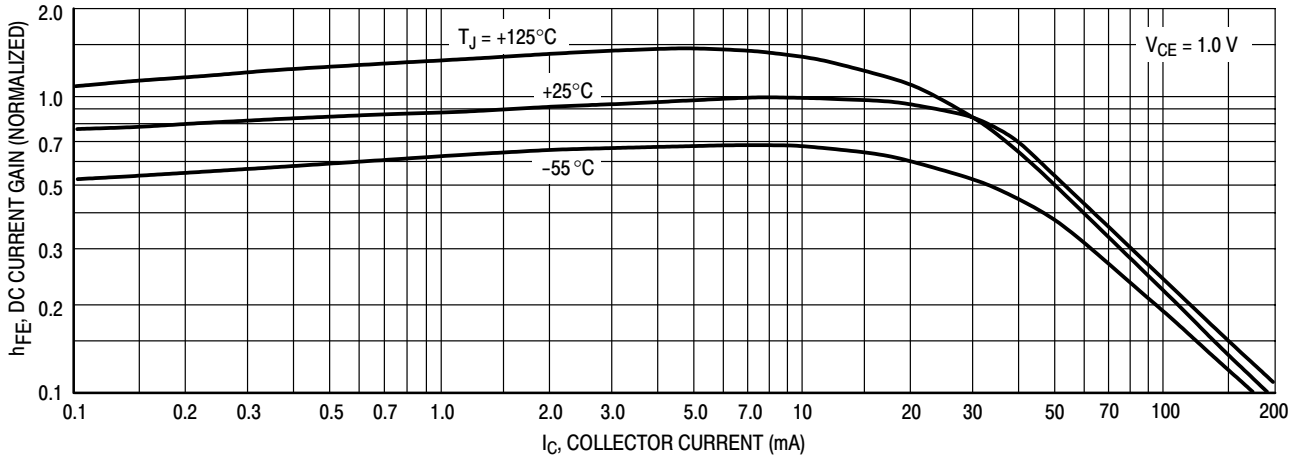

Figure 13. DC Current Gain

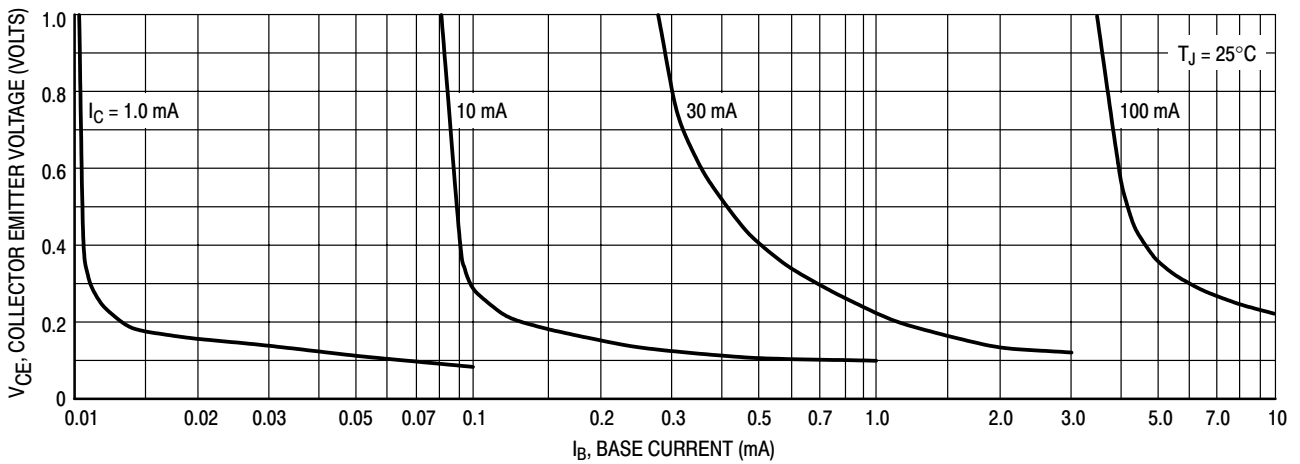

Figure 14. Collector Saturation Region

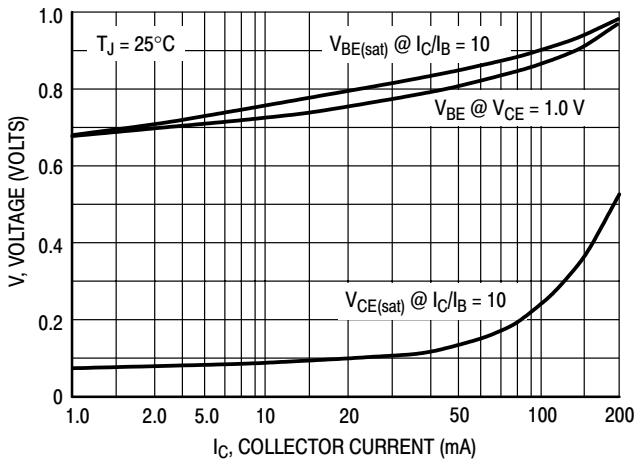

Figure 15. "ON" Voltages

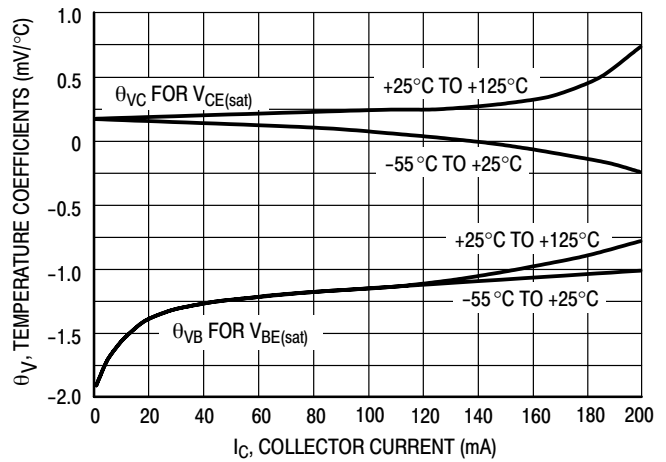
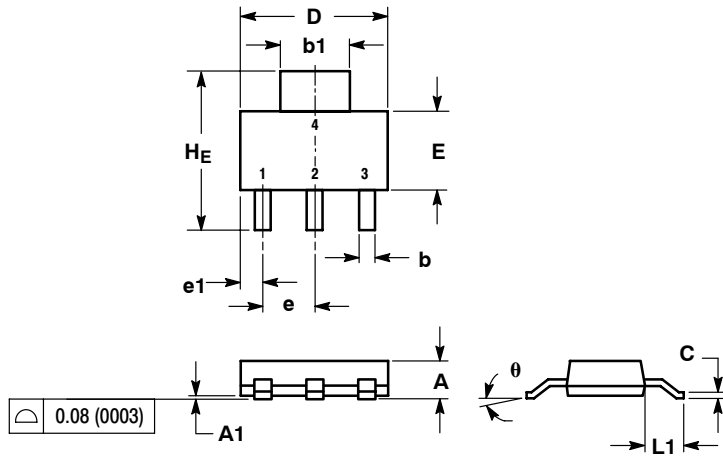

Figure 16. Temperature Coefficients

PZT3906T1

PACKAGE DIMENSIONS

SOT-223 (TO-261)
CASE 318E-04
ISSUE L



- NOTES:
1. DIMENSIONING AND TOLERANCING PER ANSI Y14.5M, 1982.
 2. CONTROLLING DIMENSION: INCH.

| DIM | MILLIMETERS | | | INCHES | | |
|-----|-------------|------|------|--------|-------|-------|
| | MIN | NOM | MAX | MIN | NOM | MAX |
| A | 1.50 | 1.63 | 1.75 | 0.060 | 0.064 | 0.068 |
| A1 | 0.02 | 0.06 | 0.10 | 0.001 | 0.002 | 0.004 |
| b | 0.60 | 0.75 | 0.89 | 0.024 | 0.030 | 0.035 |
| b1 | 2.90 | 3.06 | 3.20 | 0.115 | 0.121 | 0.126 |
| c | 0.24 | 0.29 | 0.35 | 0.009 | 0.012 | 0.014 |
| D | 6.30 | 6.50 | 6.70 | 0.249 | 0.256 | 0.263 |
| E | 3.30 | 3.50 | 3.70 | 0.130 | 0.138 | 0.145 |
| e | 2.20 | 2.30 | 2.40 | 0.087 | 0.091 | 0.094 |
| e1 | 0.85 | 0.94 | 1.05 | 0.033 | 0.037 | 0.041 |
| L1 | 1.50 | 1.75 | 2.00 | 0.060 | 0.069 | 0.078 |
| HE | 6.70 | 7.00 | 7.30 | 0.264 | 0.276 | 0.287 |
| θ | 0° | - | 10° | 0° | - | 10° |

- STYLE 1:
PIN 1. BASE
2. COLLECTOR
3. EMITTER
4. COLLECTOR

SOLDERING FOOTPRINT*

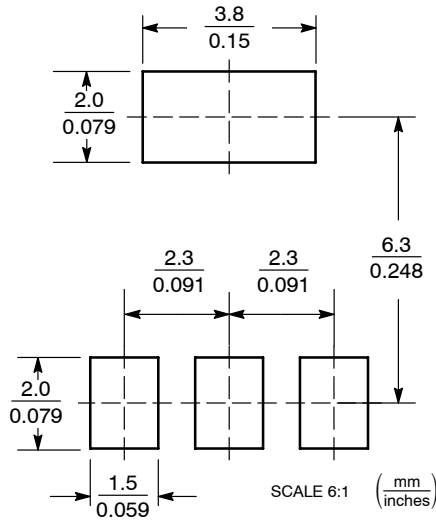

*For additional information on our Pb-Free strategy and soldering details, please download the ON Semiconductor Soldering and Mounting Techniques Reference Manual, SOLDERRM/D.

ON Semiconductor and are registered trademarks of Semiconductor Components Industries, LLC (SCILLC). SCILLC reserves the right to make changes without further notice to any products herein. SCILLC makes no warranty, representation or guarantee regarding the suitability of its products for any particular purpose, nor does SCILLC assume any liability arising out of the application or use of any product or circuit, and specifically disclaims any and all liability, including without limitation special, consequential or incidental damages. "Typical" parameters which may be provided in SCILLC data sheets and/or specifications can and do vary in different applications and actual performance may vary over time. All operating parameters, including "Typicals" must be validated for each customer application by customer's technical experts. SCILLC does not convey any license under its patent rights nor the rights of others. SCILLC products are not designed, intended, or authorized for use as components in systems intended for surgical implant into the body, or other applications intended to support or sustain life, or for any other application in which the failure of the SCILLC product could create a situation where personal injury or death may occur. Should Buyer purchase or use SCILLC products for any such unintended or unauthorized application, Buyer shall indemnify and hold SCILLC and its officers, employees, subsidiaries, affiliates, and distributors harmless against all claims, costs, damages, and expenses, and reasonable attorney fees arising out of, directly or indirectly, any claim of personal injury or death associated with such unintended or unauthorized use, even if such claim alleges that SCILLC was negligent regarding the design or manufacture of the part. SCILLC is an Equal Opportunity/Affirmative Action Employer. This literature is subject to all applicable copyright laws and is not for resale in any manner.

PUBLICATION ORDERING INFORMATION

LITERATURE FULFILLMENT:
Literature Distribution Center for ON Semiconductor
P.O. Box 61312, Phoenix, Arizona 85082-1312 USA
Phone: 480-829-7710 or 800-344-3860 Toll Free USA/Canada
Fax: 480-829-7709 or 800-344-3867 Toll Free USA/Canada
Email: orderlit@onsemi.com

N. American Technical Support: 800-282-9855 Toll Free
USA/Canada

Japan: ON Semiconductor, Japan Customer Focus Center
2-9-1 Kamimeguro, Meguro-ku, Tokyo, Japan 153-0051
Phone: 81-3-5773-3850

ON Semiconductor Website: <http://onsemi.com>

Order Literature: <http://www.onsemi.com/litorder>

For additional information, please contact your local Sales Representative.



Стандарт Электрон Связь

Мы молодая и активно развивающаяся компания в области поставок электронных компонентов. Мы поставляем электронные компоненты отечественного и импортного производства напрямую от производителей и с крупнейших складов мира.

Благодаря сотрудничеству с мировыми поставщиками мы осуществляем комплексные и плановые поставки широчайшего спектра электронных компонентов.

Собственная эффективная логистика и склад в обеспечивает надежную поставку продукции в точно указанные сроки по всей России.

Мы осуществляем техническую поддержку нашим клиентам и предпродажную проверку качества продукции. На все поставляемые продукты мы предоставляем гарантию .

Осуществляем поставки продукции под контролем ВП МО РФ на предприятия военно-промышленного комплекса России , а также работаем в рамках 275 ФЗ с открытием отдельных счетов в уполномоченном банке. Система менеджмента качества компании соответствует требованиям ГОСТ ISO 9001.

Минимальные сроки поставки, гибкие цены, неограниченный ассортимент и индивидуальный подход к клиентам являются основой для выстраивания долгосрочного и эффективного сотрудничества с предприятиями радиоэлектронной промышленности, предприятиями ВПК и научно-исследовательскими институтами России.

С нами вы становитесь еще успешнее!

Наши контакты:

Телефон: +7 812 627 14 35

Электронная почта: sales@st-electron.ru

Адрес: 198099, Санкт-Петербург,
Промышленная ул, дом № 19, литера Н,
помещение 100-Н Офис 331