

RK10J With Knob Type

Low-profile, dip and reflow solderable



Typical Specifications



Items	Specifications
Total resistance tolerance	±30%
Maximum operating voltage	50V AC, 20V DC (Single-unit only)
Total rotational angle	270° ± 10°
Rotational torque	0.5 to 10mN·m
Operating life	10,000 cycles
Operating temperature range	-10°C to +60°C

Product Line

Number of resistor elements	Knob type	Total resistance (k Ω)	Resistance taper	Soldering	Mounting type	For DC use	Minimum order unit (pcs.)		Products No.	Drawing No.
							Japan	Export		
Single-unit	Knob diameter : φ 14 Knob thickness : t0.9 Color : Black	10	1B	Manual	Insertion (2mm)	20V DC	3,000	2,400	RK10J11E0034 RK10J11E002Y RK10J12E0A0A RK10J12E002L RK10J12E0024	1
		20	3B							
Dual-unit		10	15A			Not applicable				
		20	15C							
Single-unit	Knob diameter : φ 14 Knob thickness : t1.0 Color : Black	10	15A	Reflow	Surface mounting	20V DC	3,000	3,000	RK10J11R001Y RK10J11R0A0H RK10J12R0A0B RK10J12R0052	2
			3B							
Dual-unit			15A			Not applicable				
			15C							

Notes Other varieties are also available. Refer to "Other Specifications" (P.373, 374).

Packing Specifications

Bulk / Taping

Soldering	Packing specifications	Number of packages (pcs.)			Tape width (mm)	Export package measurements (mm)
		1 reel	1 case /Japan	1 case /export packing		
Manual	Bulk	—	3,000	2,400	—	371×250×190
Reflow	Taping	1,000	3,000	3,000	24	401×397×139

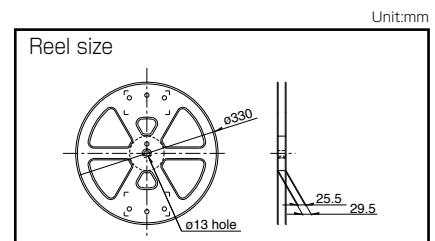

Dimensions

No.	Photo	Style	PC board mounting hole dimensions (Viewed from mounting side)
1			

Refer to P.373 for other specifications.
Refer to P.375 for ordering products not listed.
Refer to P.376 for soldering conditions.

■ Dimensions

No.	Photo	Style	PC board mounting hole dimensions (Viewed from mounting side)
2			

■ Circuit Diagram

Single-unit	Dual-unit	Dual-unit resistance taper 15C

With Knob Type / Other Specifications

In addition to the products listed, we can accommodate the follow specifications.

■ Total Resistance Variety

Total resistance (k Ω)	10	20	50	100
------------------------	----	----	----	-----

■ Resistance Taper

Resistance taper	15A	1B	3B	15C
------------------	-----	----	----	-----

■ Terminal Layout

	Resistance taper A or B		Resistance taper C	
	Single-unit	Dual-unit	Single-unit	Dual-unit
10mm Single-unit/ Dual-unit RK10J1 E				
10mm Single-unit/ Dual-unit RK10J1 R (Reflow-type)				

Refer to P.375 for ordering products not listed.

Rotary Potentiometers
 Slide Potentiometers
 Metal Shaft
 Insulated Shaft
 Knob Operating
 Through Shaft Type
 Ring Type

Mounting Plate Types and Terminal Types

Unit:mm



Knob Variety

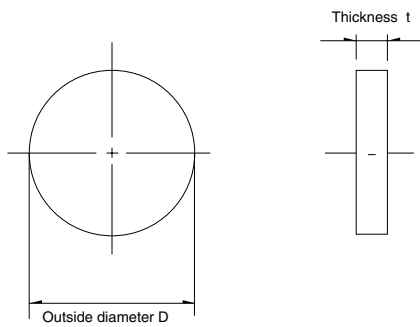

Applicable models	Knob variety			Body thickness (mm)
	Type	Outer diameter D	Thickness (mm)	
RK10J11E RK10J12E	K4	$\phi 14$	0.9	Black
	K5	$\phi 16$	3.0	
RK10J11R RK10J12R (Reflow-type)	K1	$\phi 14$	1.0	Black
	K2	$\phi 14$	2.5	
	K3	$\phi 16$		

Note

Marked are specifications recommended by Alps Alpine.

With Knob Type / Ordering Products Not Listed

When ordering product varieties that are not listed, specify referring to the examples below.

Sample Part Number

R K 1 0 J 1 1 R - **K 1** - **B 2 0 3**

Model type

Code	Model type
RK10J11E	10mm size single-unit Insertion type
RK10J12E	10mm size dual-unit Insertion type
RK10J11R	10mm size single-unit Reflow type
RK10J12R	10mm size dual-unit Reflow type

Shaft type (Outer diameter/Thickness) (mm)

Code	RK10J1□E	RK10J1□R
K1	—	V14 t1.0
K2	—	V14 t2.5
K3	—	V16 t2.5
K4	V14 t0.9	—
K5	V16 t3.0	—

*Color : Black

Resistance taper

Code	Resistance taper	Code	Resistance taper
A	15A	C	15C
B	1B	V	3B

B: For tone & general
V: For vol.

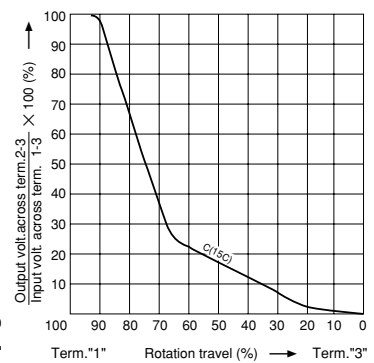
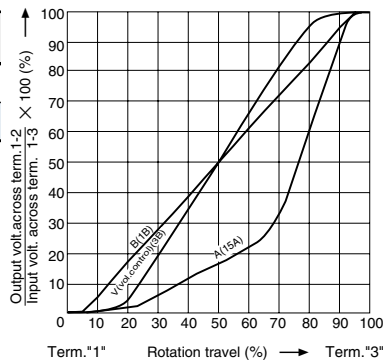

Total resistance

Code	Total resistance (k Ω)	Code	Total resistance (k Ω)
103	10	503	50
203	20	104	100







Note

Marked are specifications recommended by Alps Alpine.

Rotary Potentiometers
 Slide Potentiometers
 Metal Shaft
 Insulated Shaft
 Knob Operating
 Through Shaft Type
 Ring Type

Knob Operating Type Potentiometers

List of Varieties

Type	Without knob type			With knob type	
Series	RK08H1 □ 1	RK08H1 □ 2	RK08H1 □ 3	RK10J1 □ E	RK10J1 □ R
	Single-unit/Dual-unit	Single-unit/Dual-unit	Single-unit/Dual-unit	Single-unit/Dual-unit	Single-unit/Dual-unit
Photo					
Terminal orientation	Vertical	Back-to-back mounting	Reflow type	—	—
Operating temperature range	-10°C to +60°C				
Operating life	Without detent 10,000 cycles With detent 5,000 cycles			10,000 cycles	
Automotive use	—	—	—	—	—
Life cycle					
Electrical performance	Total resistance (k Ω)	5, 10, 20, 50, 100			10, 20, 50, 100
	Resistance taper	15A, 1B, 3B, 15C			
	Rated power	0.03W			
	Insulation resistance	—	—	—	100MΩ min. 100V DC
	Voltage proof	—	—	—	100V AC for 1minute
Mechanical performance	Detent	Without / Center detent			Without
	Stopper strength	0.1N			70mN·m
	Push-pull strength	10N			5N
Terminal style	Insertion		Reflow	Insertion	Reflow
Page	368			372	

Residual Resistance

※ Applies only to products with specified residual resistance

Nominal total resistance	※ Residual resistance
100kΩ ≥ R ≥ 50kΩ	0.1% or less of nominal total resistance
50kΩ > R > 10kΩ	30Ω or less
10kΩ ≥ R	20Ω or less

Maximum Attenuation

Nominal total resistance	Maximum attenuation
R ≥ 100kΩ	90dB min.
100kΩ > R ≥ 50kΩ	80dB min.
50kΩ > R ≥ 10kΩ	70dB min.
10kΩ > R	60dB min.

Knob Operating Type Potentiometers Soldering Conditions	376
Potentiometers Cautions	418
Potentiometers Measurement and Test Methods	420
Potentiometers Resistance Taper	422

Reference for Manual Soldering

Series	Tip temperature	Soldering time	No. of solders
RK08H1□1, RK08H1□2, RK10J	350°C max.	3s max.	1 time

Example of Reflow Soldering Condition

Temperature profile

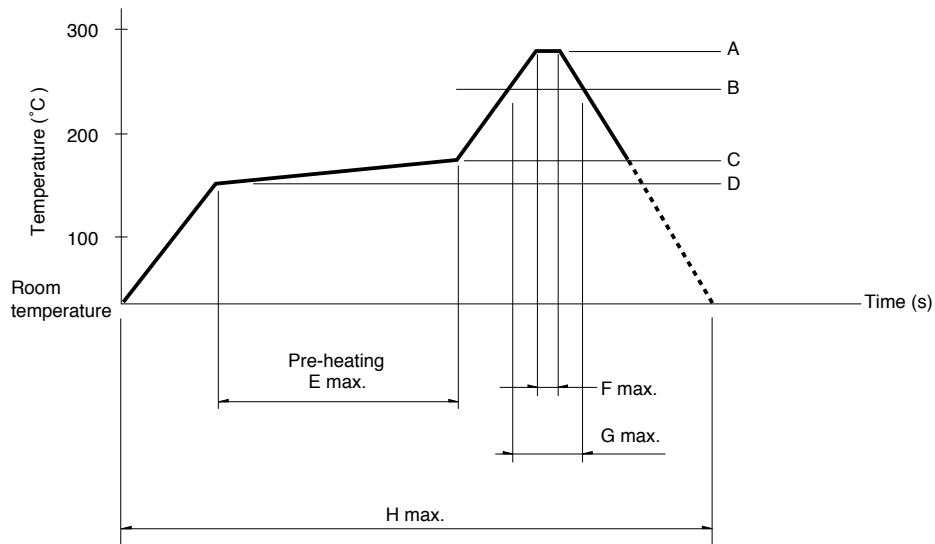

Series	A	B	C	D	E	F	G	H	No. of reflows
RK08H1□3, RK10J1□R	250°C	200°C	150°C	150°C	2 min.	3s	40s	4 min.	2 time max.

Notes

1. When using an infrared reflow oven, solder may sometimes not be applied. Be sure to use a hot air reflow oven or a type that uses infrared rays in combination with hot air.
2. The temperatures given above are the maximum temperatures at the terminals of the potentiometer when employing a hot air reflow method. The temperature of the PC board and the surface temperature of the potentiometer may vary greatly depending on the PC board material, its size and thickness. Ensure that the surface temperature of the potentiometer does not rise to 250°C or greater.
3. Conditions vary to some extent depending on the type of reflow bath used. Be sure to give due consideration to this prior to use.



Стандарт Электрон Связь

Мы молодая и активно развивающаяся компания в области поставок электронных компонентов. Мы поставляем электронные компоненты отечественного и импортного производства напрямую от производителей и с крупнейших складов мира.

Благодаря сотрудничеству с мировыми поставщиками мы осуществляем комплексные и плановые поставки широчайшего спектра электронных компонентов.

Собственная эффективная логистика и склад в обеспечивает надежную поставку продукции в точно указанные сроки по всей России.

Мы осуществляем техническую поддержку нашим клиентам и предпродажную проверку качества продукции. На все поставляемые продукты мы предоставляем гарантию .

Осуществляем поставки продукции под контролем ВП МО РФ на предприятия военно-промышленного комплекса России , а также работаем в рамках 275 ФЗ с открытием отдельных счетов в уполномоченном банке. Система менеджмента качества компании соответствует требованиям ГОСТ ISO 9001.

Минимальные сроки поставки, гибкие цены, неограниченный ассортимент и индивидуальный подход к клиентам являются основой для выстраивания долгосрочного и эффективного сотрудничества с предприятиями радиоэлектронной промышленности, предприятиями ВПК и научно-исследовательскими институтами России.

С нами вы становитесь еще успешнее!

Наши контакты:

Телефон: +7 812 627 14 35

Электронная почта: sales@st-electron.ru

Адрес: 198099, Санкт-Петербург,
Промышленная ул, дом № 19, литера Н,
помещение 100-Н Офис 331