

RK10J With Knob Type

Low-profile, dip and reflow solderable



Typical Specifications



| Items | Specifications |
|-----------------------------|-----------------------------------|
| Total resistance tolerance | ±30% |
| Maximum operating voltage | 50V AC, 20V DC (Single-unit only) |
| Total rotational angle | 270° ± 10° |
| Rotational torque | 0.5 to 10mN·m |
| Operating life | 10,000 cycles |
| Operating temperature range | -10°C to +60°C |

Product Line

| Number of resistor elements | Knob type | Total resistance (k Ω) | Resistance taper | Soldering | Mounting type | For DC use | Minimum order unit (pcs.) | | Products No. | Drawing No. |
|-----------------------------|--|------------------------|------------------|-----------|------------------|----------------|---------------------------|--------|--|-------------|
| | | | | | | | Japan | Export | | |
| Single-unit | Knob diameter : φ 14 Knob thickness : t0.9 Color : Black | 10 | 1B | Manual | Insertion (2mm) | 20V DC | 3,000 | 2,400 | RK10J11E0034 RK10J11E002Y RK10J12E0A0A RK10J12E002L RK10J12E0024 | 1 |
| | | 20 | 3B | | | | | | | |
| Dual-unit | | 10 | 15A | | | Not applicable | | | | |
| | | 20 | 15C | | | | | | | |
| Single-unit | Knob diameter : φ 14 Knob thickness : t1.0 Color : Black | 10 | 15A | Reflow | Surface mounting | 20V DC | 3,000 | 3,000 | RK10J11R001Y RK10J11R0A0H RK10J12R0A0B RK10J12R0052 | 2 |
| | | | 3B | | | | | | | |
| Dual-unit | | | 15A | | | Not applicable | | | | |
| | | | 15C | | | | | | | |

Notes Other varieties are also available. Refer to "Other Specifications" (P.373, 374).

Packing Specifications

Bulk / Taping

| Soldering | Packing specifications | Number of packages (pcs.) | | | Tape width (mm) | Export package measurements (mm) |
|-----------|------------------------|---------------------------|---------------|------------------------|-----------------|----------------------------------|
| | | 1 reel | 1 case /Japan | 1 case /export packing | | |
| Manual | Bulk | — | 3,000 | 2,400 | — | 371×250×190 |
| Reflow | Taping | 1,000 | 3,000 | 3,000 | 24 | 401×397×139 |



Dimensions

| No. | Photo | Style | PC board mounting hole dimensions (Viewed from mounting side) |
|-----|-------|-------|---|
| 1 | | | |

Refer to P.373 for other specifications.
Refer to P.375 for ordering products not listed.
Refer to P.376 for soldering conditions.

■ Dimensions

| No. | Photo | Style | PC board mounting hole dimensions (Viewed from mounting side) |
|-----|-------|-------|--|
| 2 | | | |

■ Circuit Diagram

| Single-unit | Dual-unit | Dual-unit resistance taper 15C |
|-------------|-----------|--------------------------------|
| | | |

With Knob Type / Other Specifications

In addition to the products listed, we can accommodate the follow specifications.

■ Total Resistance Variety

| | | | | |
|------------------------|----|----|----|-----|
| Total resistance (k Ω) | 10 | 20 | 50 | 100 |
|------------------------|----|----|----|-----|

■ Resistance Taper

| | | | | |
|------------------|-----|----|----|-----|
| Resistance taper | 15A | 1B | 3B | 15C |
|------------------|-----|----|----|-----|

■ Terminal Layout

| | Resistance taper A or B | | Resistance taper C | |
|---|-------------------------|-----------|--------------------|-----------|
| | Single-unit | Dual-unit | Single-unit | Dual-unit |
| 10mm Single-unit/ Dual-unit RK10J1□E | | | | |
| 10mm Single-unit/ Dual-unit RK10J1□R (Reflow-type) | | | | |

Refer to P.375 for ordering products not listed.

Rotary Potentiometers
 Slide Potentiometers
 Metal Shaft
 Insulated Shaft
 Knob Operating
 Through Shaft Type
 Ring Type

Mounting Plate Types and Terminal Types

Unit:mm



Knob Variety

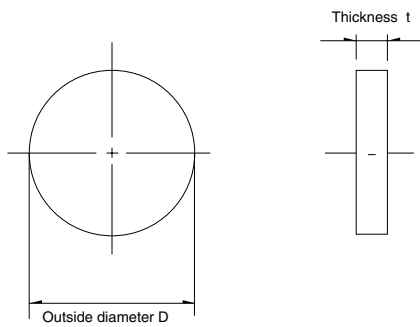

| Applicable models | Knob variety | | | Body thickness (mm) |
|---|--------------|------------------|----------------|---------------------|
| | Type | Outer diameter D | Thickness (mm) | |
| RK10J11E RK10J12E | K4 | $\phi 14$ | 0.9 | Black |
| | K5 | $\phi 16$ | 3.0 | |
| RK10J11R RK10J12R (Reflow-type) | K1 | $\phi 14$ | 1.0 | Black |
| | K2 | $\phi 14$ | 2.5 | |
| | K3 | $\phi 16$ | | |

Note

Marked are specifications recommended by Alps Alpine.

With Knob Type / Ordering Products Not Listed

When ordering product varieties that are not listed, specify referring to the examples below.

Sample Part Number

R K 1 0 J 1 1 R - **K 1** - **B 2 0 3**

Model type

| Code | Model type |
|----------|--------------------------------------|
| RK10J11E | 10mm size single-unit Insertion type |
| RK10J12E | 10mm size dual-unit Insertion type |
| RK10J11R | 10mm size single-unit Reflow type |
| RK10J12R | 10mm size dual-unit Reflow type |

Shaft type (Outer diameter/Thickness) (mm)

| Code | RK10J1□E | RK10J1□R |
|------|----------|----------|
| K1 | — | V14 t1.0 |
| K2 | — | V14 t2.5 |
| K3 | — | V16 t2.5 |
| K4 | V14 t0.9 | — |
| K5 | V16 t3.0 | — |

*Color : Black

Resistance taper

| Code | Resistance taper | Code | Resistance taper |
|------|------------------|------|------------------|
| A | 15A | C | 15C |
| B | 1B | V | 3B |

B: For tone & general
V: For vol.

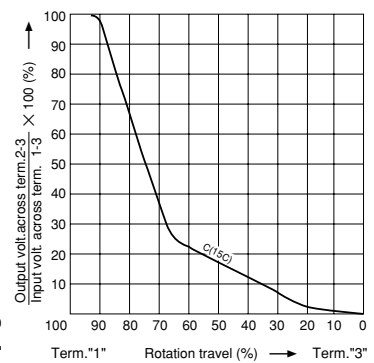
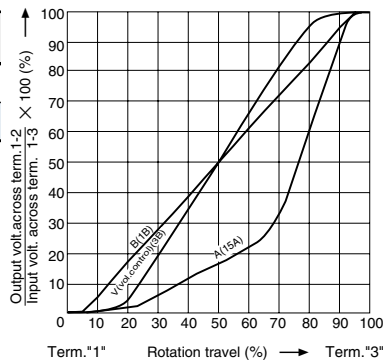

Total resistance

| Code | Total resistance (k Ω) | Code | Total resistance (k Ω) |
|------|------------------------|------|------------------------|
| 103 | 10 | 503 | 50 |
| 203 | 20 | 104 | 100 |







Note

Marked are specifications recommended by Alps Alpine.

Rotary Potentiometers
 Slide Potentiometers
 Metal Shaft
 Insulated Shaft
 Knob Operating
 Through Shaft Type
 Ring Type

Knob Operating Type Potentiometers

List of Varieties

| Type | Without knob type | | | With knob type | |
|-----------------------------|---|---|--|---|---|
| Series | RK08H1 □ 1 | RK08H1 □ 2 | RK08H1 □ 3 | RK10J1 □ E | RK10J1 □ R |
| | Single-unit/Dual-unit | Single-unit/Dual-unit | Single-unit/Dual-unit | Single-unit/Dual-unit | Single-unit/Dual-unit |
| Photo |  |  |  |  |  |
| Terminal orientation | Vertical | Back-to-back mounting | Reflow type | — | — |
| Operating temperature range | -10°C to +60°C | | | | |
| Operating life | Without detent 10,000 cycles With detent 5,000 cycles | | | 10,000 cycles | |
| Automotive use | — | — | — | — | — |
| Life cycle |  | | |  | |
| Electrical performance | Total resistance (k Ω) | 5, 10, 20, 50, 100 | | | 10, 20, 50, 100 |
| | Resistance taper | 15A, 1B, 3B, 15C | | | |
| | Rated power | 0.03W | | | |
| | Insulation resistance | — | — | — | 100MΩ min. 100V DC |
| | Voltage proof | — | — | — | 100V AC for 1minute |
| Mechanical performance | Detent | Without / Center detent | | | Without |
| | Stopper strength | 0.1N | | | 70mN·m |
| | Push-pull strength | 10N | | | 5N |
| Terminal style | Insertion | | Reflow | Insertion | Reflow |
| Page | 368 | | | 372 | |

Residual Resistance

※ Applies only to products with specified residual resistance

| Nominal total resistance | ※ Residual resistance |
|--------------------------|--|
| 100kΩ ≥ R ≥ 50kΩ | 0.1% or less of nominal total resistance |
| 50kΩ > R > 10kΩ | 30Ω or less |
| 10kΩ ≥ R | 20Ω or less |

Maximum Attenuation

| Nominal total resistance | Maximum attenuation |
|--------------------------|---------------------|
| R ≥ 100kΩ | 90dB min. |
| 100kΩ > R ≥ 50kΩ | 80dB min. |
| 50kΩ > R ≥ 10kΩ | 70dB min. |
| 10kΩ > R | 60dB min. |

| | |
|---|-----|
| Knob Operating Type Potentiometers Soldering Conditions | 376 |
| Potentiometers Cautions | 418 |
| Potentiometers Measurement and Test Methods | 420 |
| Potentiometers Resistance Taper | 422 |

Rotary Potentiometers
 Slide Potentiometers
 Metal Shaft
 Insulated Shaft
 Knob Operating
 Through Shaft Type
 Ring Type

Reference for Manual Soldering

| Series | Tip temperature | Soldering time | No. of solders |
|----------------------------------|-----------------|----------------|----------------|
| RK08H1□1, RK08H1□2, RK10J | 350°C max. | 3s max. | 1 time |

Example of Reflow Soldering Condition

Temperature profile

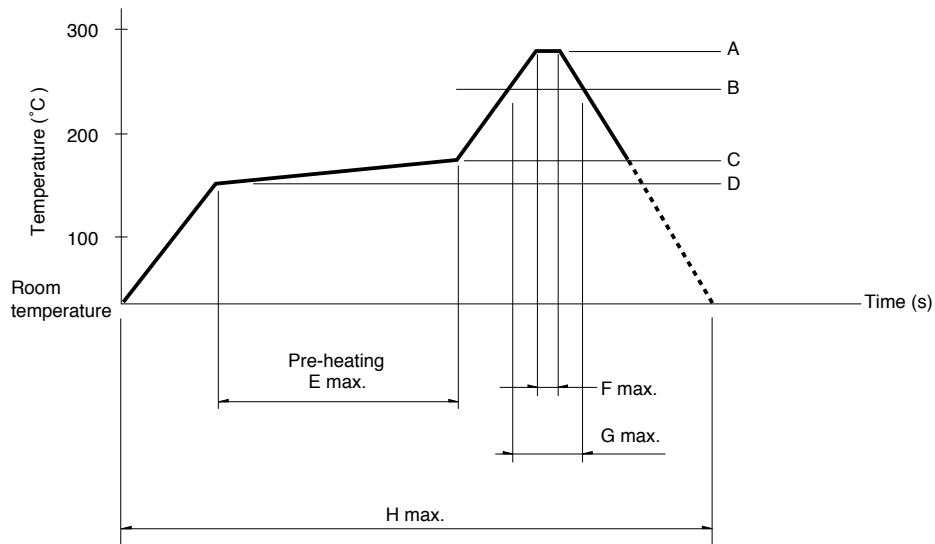

| Series | A | B | C | D | E | F | G | H | No. of reflows |
|---------------------------|-------|-------|-------|-------|--------|----|-----|--------|----------------|
| RK08H1□3, RK10J1□R | 250°C | 200°C | 150°C | 150°C | 2 min. | 3s | 40s | 4 min. | 2 time max. |

Notes

1. When using an infrared reflow oven, solder may sometimes not be applied. Be sure to use a hot air reflow oven or a type that uses infrared rays in combination with hot air.
2. The temperatures given above are the maximum temperatures at the terminals of the potentiometer when employing a hot air reflow method. The temperature of the PC board and the surface temperature of the potentiometer may vary greatly depending on the PC board material, its size and thickness. Ensure that the surface temperature of the potentiometer does not rise to 250°C or greater.
3. Conditions vary to some extent depending on the type of reflow bath used. Be sure to give due consideration to this prior to use.



**Стандарт
Электрон
Связь**

Мы молодая и активно развивающаяся компания в области поставок электронных компонентов. Мы поставляем электронные компоненты отечественного и импортного производства напрямую от производителей и с крупнейших складов мира.

Благодаря сотрудничеству с мировыми поставщиками мы осуществляем комплексные и плановые поставки широчайшего спектра электронных компонентов.

Собственная эффективная логистика и склад в обеспечивает надежную поставку продукции в точно указанные сроки по всей России.

Мы осуществляем техническую поддержку нашим клиентам и предпродажную проверку качества продукции. На все поставляемые продукты мы предоставляем гарантию .

Осуществляем поставки продукции под контролем ВП МО РФ на предприятия военно-промышленного комплекса России , а также работаем в рамках 275 ФЗ с открытием отдельных счетов в уполномоченном банке. Система менеджмента качества компании соответствует требованиям ГОСТ ISO 9001.

Минимальные сроки поставки, гибкие цены, неограниченный ассортимент и индивидуальный подход к клиентам являются основой для выстраивания долгосрочного и эффективного сотрудничества с предприятиями радиоэлектронной промышленности, предприятиями ВПК и научно-исследовательскими институтами России.

С нами вы становитесь еще успешнее!

Наши контакты:

Телефон: +7 812 627 14 35

Электронная почта: sales@st-electron.ru

Адрес: 198099, Санкт-Петербург,
Промышленная ул, дом № 19, литера Н,
помещение 100-Н Офис 331