



Is Now Part of



**ON Semiconductor®**

To learn more about ON Semiconductor, please visit our website at  
[www.onsemi.com](http://www.onsemi.com)

Please note: As part of the Fairchild Semiconductor integration, some of the Fairchild orderable part numbers will need to change in order to meet ON Semiconductor's system requirements. Since the ON Semiconductor product management systems do not have the ability to manage part nomenclature that utilizes an underscore (\_), the underscore (\_) in the Fairchild part numbers will be changed to a dash (-). This document may contain device numbers with an underscore (\_). Please check the ON Semiconductor website to verify the updated device numbers. The most current and up-to-date ordering information can be found at [www.onsemi.com](http://www.onsemi.com). Please email any questions regarding the system integration to [Fairchild\\_questions@onsemi.com](mailto:Fairchild_questions@onsemi.com).

ON Semiconductor and the ON Semiconductor logo are trademarks of Semiconductor Components Industries, LLC dba ON Semiconductor or its subsidiaries in the United States and/or other countries. ON Semiconductor owns the rights to a number of patents, trademarks, copyrights, trade secrets, and other intellectual property. A listing of ON Semiconductor's product/patent coverage may be accessed at [www.onsemi.com/site/pdf/Patent-Marking.pdf](http://www.onsemi.com/site/pdf/Patent-Marking.pdf). ON Semiconductor reserves the right to make changes without further notice to any products herein. ON Semiconductor makes no warranty, representation or guarantee regarding the suitability of its products for any particular purpose, nor does ON Semiconductor assume any liability arising out of the application or use of any product or circuit, and specifically disclaims any and all liability, including without limitation special, consequential or incidental damages. Buyer is responsible for its products and applications using ON Semiconductor products, including compliance with all laws, regulations and safety requirements or standards, regardless of any support or applications information provided by ON Semiconductor. "Typical" parameters which may be provided in ON Semiconductor data sheets and/or specifications can and do vary in different applications and actual performance may vary over time. All operating parameters, including "Typicals" must be validated for each customer application by customer's technical experts. ON Semiconductor does not convey any license under its patent rights nor the rights of others. ON Semiconductor products are not designed, intended, or authorized for use as a critical component in life support systems or any FDA Class 3 medical devices or medical devices with a same or similar classification in a foreign jurisdiction or any devices intended for implantation in the human body. Should Buyer purchase or use ON Semiconductor products for any such unintended or unauthorized application, Buyer shall indemnify and hold ON Semiconductor and its officers, employees, subsidiaries, affiliates, and distributors harmless against all claims, costs, damages, and expenses, and reasonable attorney fees arising out of, directly or indirectly, any claim of personal injury or death associated with such unintended or unauthorized use, even if such claim alleges that ON Semiconductor was negligent regarding the design or manufacture of the part. ON Semiconductor is an Equal Opportunity/Affirmative Action Employer. This literature is subject to all applicable copyright laws and is not for resale in any manner.

## 74VHC138

### 3-to-8 Decoder/Demultiplexer

#### General Description

The VHC138 is an advanced high speed CMOS 3-to-8 decoder/demultiplexer fabricated with silicon gate CMOS technology. It achieves the high speed operation similar to equivalent Bipolar Schottky TTL while maintaining the CMOS low power dissipation.

When the device is enabled, 3 binary select inputs ( $A_0$ ,  $A_1$  and  $A_2$ ) determine which one of the outputs ( $\overline{O}_0$ – $\overline{O}_7$ ) will go LOW. When enable input  $E_3$  is held LOW or either  $\overline{E}_1$  or  $\overline{E}_2$  is held HIGH, decoding function is inhibited and all outputs go HIGH.  $E_3$ ,  $\overline{E}_1$  and  $\overline{E}_2$  inputs are provided to ease cascade connection and for use as an address decoder for memory systems. An input protection circuit ensures that

0V to 7V can be applied to the input pins without regard to the supply voltage. This device can be used to interface 5V to 3V systems and two supply systems such as battery back up. This circuit prevents device destruction due to mismatched supply and input voltages.

#### Features

- High Speed:  $t_{PD} = 5.7ns$  (typ) at  $T_A = 25^\circ C$
- Low power dissipation:  $I_{CC} = 4 \mu A$  (max.) at  $T_A = 25^\circ C$
- High noise immunity:  $V_{NIH} = V_{NIL} = 28\% V_{CC}$  (min.)
- Power down protection provided on all inputs
- Pin and function compatible with 74HC138

#### Ordering Code:

Order Number	Package Number	Package Description
74VHC138M	M16A	16-Lead Small Outline Integrated Circuit (SOIC), JEDEC MS-012, 0.150" Narrow
74VHC138SJ	M16D	16-Lead Small Outline Package (SOP), EIAJ TYPE II, 5.3mm Wide
74VHC138MTC	MTC16	16-Lead Thin Shrink Small Outline Package (TSSOP), JEDEC MO-153, 4.4mm Wide
74VHC138N	N16E	16-Lead Plastic Dual-In-Line Package (PDIP), JEDEC MS-001, 0.300" Wide

Surface mount packages are also available on Tape and Reel. Specify by appending the suffix letter "X" to the ordering code.

#### Logic Symbols

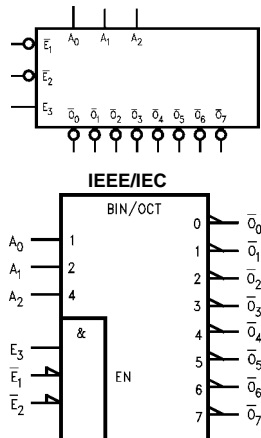

#### Connection Diagram

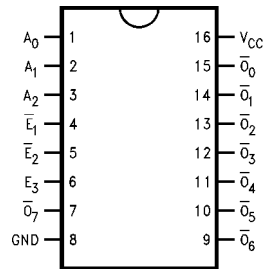

#### Pin Descriptions

Pin Names	Description
$A_0$ – $A_2$	Address Inputs
$\overline{E}_1$ – $\overline{E}_2$	Enable Inputs
$E_3$	Enable Input
$\overline{O}_0$ – $\overline{O}_7$	Outputs

## Truth Table

Inputs						Outputs							
$\overline{E}_1$	$\overline{E}_2$	$E_3$	$A_0$	$A_1$	$A_2$	$\overline{O}_0$	$\overline{O}_1$	$\overline{O}_2$	$\overline{O}_3$	$\overline{O}_4$	$\overline{O}_5$	$\overline{O}_6$	$\overline{O}_7$
H	X	X	X	X	X	H	H	H	H	H	H	H	H
X	H	X	X	X	X	H	H	H	H	H	H	H	H
X	X	L	X	X	X	H	H	H	H	H	H	H	H
L	L	H	L	L	L	L	H	H	H	H	H	H	H
L	L	H	H	L	L	H	L	H	H	H	H	H	H
L	L	H	L	H	L	H	H	L	H	H	H	H	H
L	L	H	H	H	L	H	H	H	L	H	H	H	H
L	L	H	L	L	H	H	H	H	H	L	H	H	H
L	L	H	H	L	H	H	H	H	H	H	L	H	H
L	L	H	L	H	H	H	H	H	H	H	H	L	H
L	L	H	H	H	H	H	H	H	H	H	H	H	L

H = HIGH Voltage Level  
L = LOW Voltage Level  
X = Immaterial

**Absolute Maximum Ratings** (Note 1)

Supply Voltage ( $V_{CC}$ )	-0.5V to +7.0V
DC Input Voltage ( $V_{IN}$ )	-0.5V to +7.0V
DC Output Voltage ( $V_{OUT}$ )	-0.5V to $V_{CC} + 0.5V$
Input Diode Current ( $I_{IK}$ )	-20 mA
Output Diode Current ( $I_{OK}$ )	$\pm 20$ mA
DC Output Current ( $I_{OUT}$ )	$\pm 25$ mA
DC $V_{CC}$ /GND Current ( $I_{CC}$ )	$\pm 75$ mA
Storage Temperature ( $T_{STG}$ )	-65°C to +150°C
Lead Temperature ( $T_L$ ) (Soldering, 10 seconds)	260°C

**Recommended Operating Conditions** (Note 2)

Supply Voltage ( $V_{CC}$ )	2.0V to +5.5V
Input Voltage ( $V_{IN}$ )	0V to +5.5V
Output Voltage ( $V_{OUT}$ )	0V to $V_{CC}$
Operating Temperature ( $T_{OPR}$ )	-40°C to +85°C
Input Rise and Fall Time ( $t_r, t_f$ )	
$V_{CC} = 3.3V \pm 0.3V$	0 ~ 100 ns/V
$V_{CC} = 5.0V \pm 0.5V$	0 ~ 20 ns/V

**Note 1:** Absolute Maximum Ratings are values beyond which the device may be damaged or have its useful life impaired. The databook specifications should be met, without exception, to ensure that the system design is reliable over its power supply, temperature, and output/input loading variables. Fairchild does not recommend operation outside databook specifications.

**Note 2:** Unused inputs must be held HIGH or LOW. They may not float.

**DC Electrical Characteristics**

Symbol	Parameter	$V_{CC}$ (V)	$T_A = 25^\circ\text{C}$			$T_A = -40^\circ\text{C to } +85^\circ\text{C}$		Units	Conditions	
			Min	Typ	Max	Min	Max			
$V_{IH}$	HIGH Level Input Voltage	2.0 3.0 – 5.5	1.50 $0.7 V_{CC}$			1.50 $0.7 V_{CC}$		V		
$V_{IL}$	LOW Level Input Voltage	2.0 3.0 – 5.5			0.50 $0.3 V_{CC}$	0.50 $0.3 V_{CC}$		V		
$V_{OH}$	HIGH Level Output Voltage	2.0	1.9	2.0		1.9		V	$V_{IN} = V_{IH}$ or $V_{IL}$	$I_{OH} = -50 \mu\text{A}$
		3.0	2.9	3.0		2.9				
		4.5	4.4	4.5		4.4		V		$I_{OH} = -4 \text{ mA}$ $I_{OH} = -8 \text{ mA}$
		3.0	2.58			2.48				
4.5	3.94			3.80						
$V_{OL}$	LOW Level Output Voltage	2.0		0.0	0.1		0.1	V	$V_{IN} = V_{IH}$ or $V_{IL}$	$I_{OL} = 50 \mu\text{A}$
		3.0		0.0	0.1		0.1			
		4.5		0.0	0.1		0.1	V		$I_{OL} = 4 \text{ mA}$ $I_{OL} = 8 \text{ mA}$
		3.0			0.36		0.44			
4.5			0.36		0.44					
$I_{IN}$	Input Leakage Current	0 – 5.5			$\pm 0.1$	$\pm 1.0$		$\mu\text{A}$	$V_{IN} = 5.5V$ or GND	
$I_{CC}$	Quiescent Supply Current	5.5			4.0	40.0		$\mu\text{A}$	$V_{IN} = V_{CC}$ or GND	

## AC Electrical Characteristics

Symbol	Parameter	V <sub>CC</sub> (V)	T <sub>A</sub> = 25°C			T <sub>A</sub> = -40°C to +85°C		Units	Conditions
			Min	Typ	Max	Min	Max		
t <sub>PLH</sub>	Propagation Delay A <sub>n</sub> to $\overline{O}_n$	3.3 ± 0.3	8.2	11.4	1.0	13.5	ns	C <sub>L</sub> = 15 pF	
t <sub>PHL</sub>			10.0	15.8	1.0	18.0		C <sub>L</sub> = 50 pF	
		5.0 ± 0.5	5.7	8.1	1.0	9.5	ns	C <sub>L</sub> = 15 pF	
			7.2	10.1	1.0	11.5		C <sub>L</sub> = 50 pF	
t <sub>PLH</sub>	Propagation Delay E <sub>3</sub> to $\overline{O}_n$	3.3 ± 0.3	8.1	12.8	1.0	15.0	ns	C <sub>L</sub> = 15 pF	
t <sub>PHL</sub>			10.6	16.3	1.0	18.5		C <sub>L</sub> = 50 pF	
		5.0 ± 0.5	5.6	8.1	1.0	9.5	ns	C <sub>L</sub> = 15 pF	
			7.1	10.1	1.0	11.5		C <sub>L</sub> = 50 pF	
t <sub>PLH</sub>	Propagation Delay $\overline{E}_1$ or $\overline{E}_2$ to $\overline{O}_n$	3.3 ± 0.3	8.2	11.4	1.0	13.5	ns	C <sub>L</sub> = 15 pF	
t <sub>PHL</sub>			10.7	14.9	1.0	17.0		C <sub>L</sub> = 50 pF	
		5.0 ± 0.5	5.8	8.1	1.0	9.5	ns	C <sub>L</sub> = 15 pF	
			7.3	10.1	1.0	11.5		C <sub>L</sub> = 50 pF	
C <sub>IN</sub>	Input Capacitance		4	10		10	pF	V <sub>CC</sub> = Open	
C <sub>PD</sub>	Power Dissipation Capacitance		34				pF	(Note 3)	

**Note 3:** C<sub>PD</sub> is defined as the value of the internal equivalent capacitance which is calculated from the operating current consumption without load. Average operating current can be obtained by the equation: I<sub>CC (opr.)</sub> = C<sub>PD</sub> \* V<sub>CC</sub> \* f<sub>IN</sub> + I<sub>CC</sub>.

**Physical Dimensions** inches (millimeters) unless otherwise noted

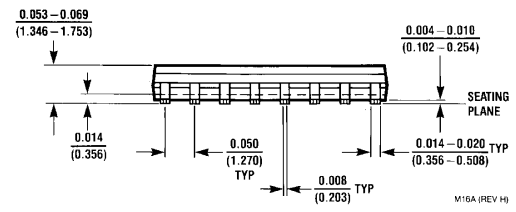
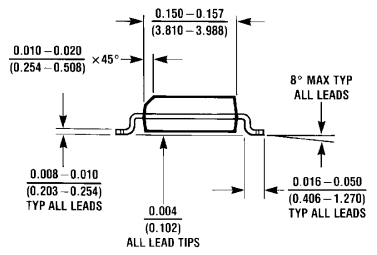
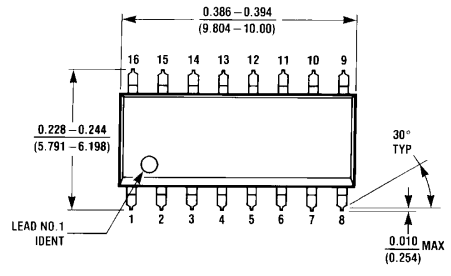

**16-Lead Small Outline Integrated Circuit (SOIC), JEDEC MS-012, 0.150" Narrow  
Package Number M16A**

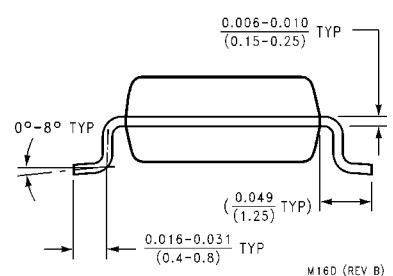
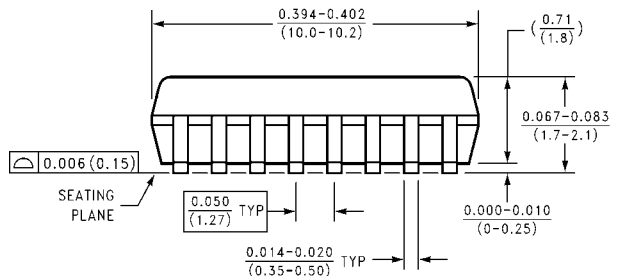
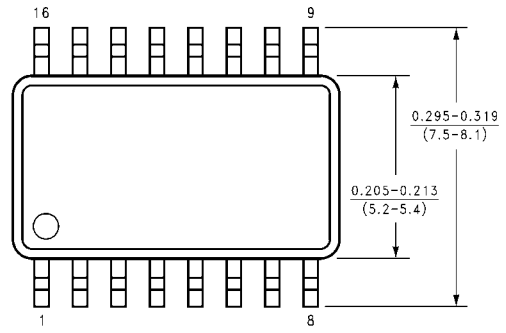

**16-Lead Small Outline Package (SOP) EIAJ TYPE II, 5.3mm Wide  
Package Number M16D**

**Physical Dimensions** inches (millimeters) unless otherwise noted (Continued)

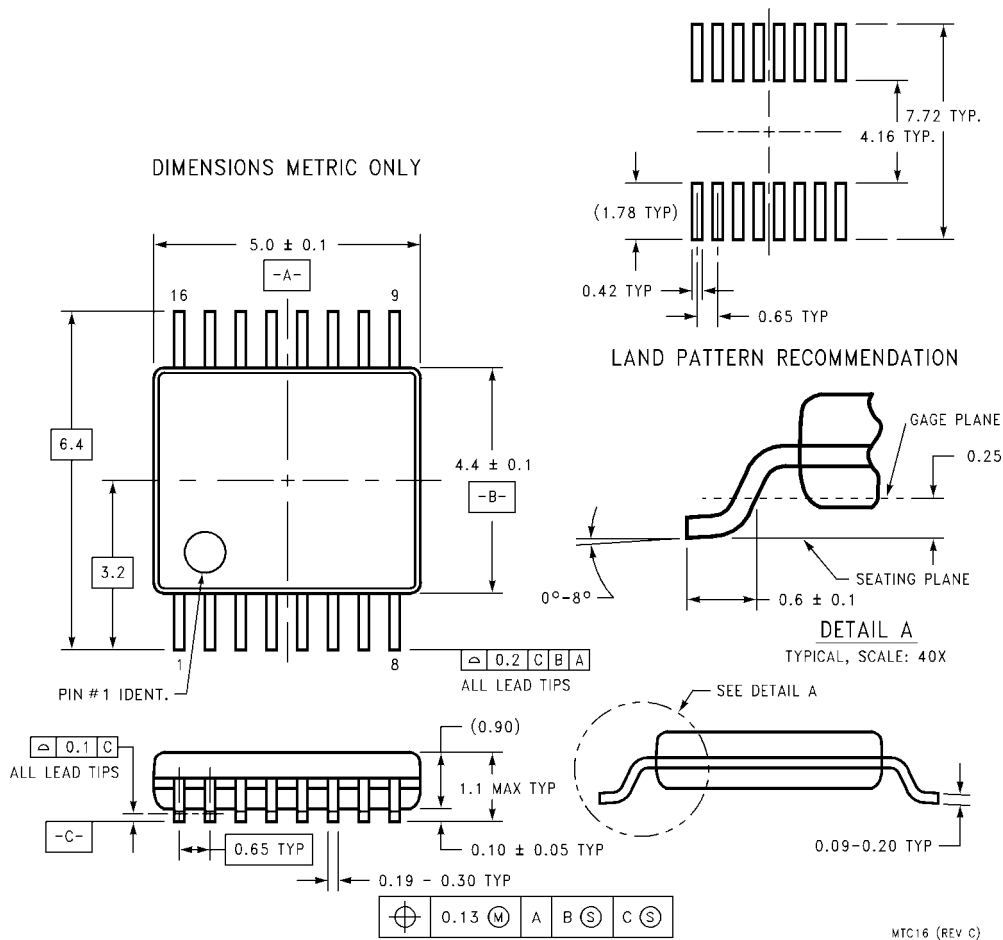

**16-Lead Thin Shrink Small Outline Package (TSSOP), JEDEC MO-153, 4.4mm Wide  
Package Number MTC16**

MTC16 (REV C)

**Physical Dimensions** inches (millimeters) unless otherwise noted (Continued)

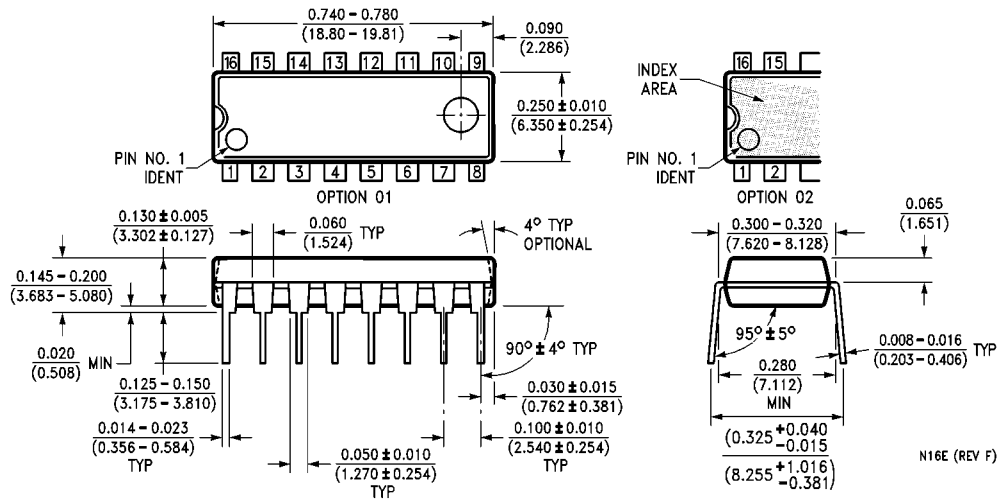

**16-Lead Plastic Dual-In-Line Package (PDIP), JEDEC MS-001, 0.300" Wide Package Number N16E**

**LIFE SUPPORT POLICY**

FAIRCHILD'S PRODUCTS ARE NOT AUTHORIZED FOR USE AS CRITICAL COMPONENTS IN LIFE SUPPORT DEVICES OR SYSTEMS WITHOUT THE EXPRESS WRITTEN APPROVAL OF THE PRESIDENT OF FAIRCHILD SEMICONDUCTOR CORPORATION. As used herein:

1. Life support devices or systems are devices or systems which, (a) are intended for surgical implant into the body, or (b) support or sustain life, and (c) whose failure to perform when properly used in accordance with instructions for use provided in the labeling, can be reasonably expected to result in a significant injury to the user.
2. A critical component in any component of a life support device or system whose failure to perform can be reasonably expected to cause the failure of the life support device or system, or to affect its safety or effectiveness.

[www.fairchildsemi.com](http://www.fairchildsemi.com)

Fairchild does not assume any responsibility for use of any circuitry described, no circuit patent licenses are implied and Fairchild reserves the right at any time without notice to change said circuitry and specifications.



ON Semiconductor and  are trademarks of Semiconductor Components Industries, LLC dba ON Semiconductor or its subsidiaries in the United States and/or other countries. ON Semiconductor owns the rights to a number of patents, trademarks, copyrights, trade secrets, and other intellectual property. A listing of ON Semiconductor's product/patent coverage may be accessed at [www.onsemi.com/site/pdf/Patent-Marking.pdf](http://www.onsemi.com/site/pdf/Patent-Marking.pdf). ON Semiconductor reserves the right to make changes without further notice to any products herein. ON Semiconductor makes no warranty, representation or guarantee regarding the suitability of its products for any particular purpose, nor does ON Semiconductor assume any liability arising out of the application or use of any product or circuit, and specifically disclaims any and all liability, including without limitation special, consequential or incidental damages. Buyer is responsible for its products and applications using ON Semiconductor products, including compliance with all laws, regulations and safety requirements or standards, regardless of any support or applications information provided by ON Semiconductor. "Typical" parameters which may be provided in ON Semiconductor data sheets and/or specifications can and do vary in different applications and actual performance may vary over time. All operating parameters, including "Typicals" must be validated for each customer application by customer's technical experts. ON Semiconductor does not convey any license under its patent rights nor the rights of others. ON Semiconductor products are not designed, intended, or authorized for use as a critical component in life support systems or any FDA Class 3 medical devices or medical devices with a same or similar classification in a foreign jurisdiction or any devices intended for implantation in the human body. Should Buyer purchase or use ON Semiconductor products for any such unintended or unauthorized application, Buyer shall indemnify and hold ON Semiconductor and its officers, employees, subsidiaries, affiliates, and distributors harmless against all claims, costs, damages, and expenses, and reasonable attorney fees arising out of, directly or indirectly, any claim of personal injury or death associated with such unintended or unauthorized use, even if such claim alleges that ON Semiconductor was negligent regarding the design or manufacture of the part. ON Semiconductor is an Equal Opportunity/Affirmative Action Employer. This literature is subject to all applicable copyright laws and is not for resale in any manner.

## PUBLICATION ORDERING INFORMATION

### LITERATURE FULFILLMENT:

Literature Distribution Center for ON Semiconductor  
19521 E. 32nd Pkwy, Aurora, Colorado 80011 USA  
**Phone:** 303-675-2175 or 800-344-3860 Toll Free USA/Canada  
**Fax:** 303-675-2176 or 800-344-3867 Toll Free USA/Canada  
**Email:** [orderlit@onsemi.com](mailto:orderlit@onsemi.com)

**N. American Technical Support:** 800-282-9855 Toll Free  
USA/Canada  
**Europe, Middle East and Africa Technical Support:**  
Phone: 421 33 790 2910  
**Japan Customer Focus Center**  
Phone: 81-3-5817-1050

**ON Semiconductor Website:** [www.onsemi.com](http://www.onsemi.com)  
**Order Literature:** <http://www.onsemi.com/orderlit>  
For additional information, please contact your local  
Sales Representative

# Mouser Electronics

Authorized Distributor

Click to View Pricing, Inventory, Delivery & Lifecycle Information:

[ON Semiconductor:](#)

[74VHC138SJX](#) [74VHC138MTC](#) [74VHC138M](#) [74VHC138MTCX](#) [74VHC138MX](#)



**Стандарт  
Электрон  
Связь**

Мы молодая и активно развивающаяся компания в области поставок электронных компонентов. Мы поставляем электронные компоненты отечественного и импортного производства напрямую от производителей и с крупнейших складов мира.

Благодаря сотрудничеству с мировыми поставщиками мы осуществляем комплексные и плановые поставки широчайшего спектра электронных компонентов.

Собственная эффективная логистика и склад в обеспечивает надежную поставку продукции в точно указанные сроки по всей России.

Мы осуществляем техническую поддержку нашим клиентам и предпродажную проверку качества продукции. На все поставляемые продукты мы предоставляем гарантию .

Осуществляем поставки продукции под контролем ВП МО РФ на предприятия военно-промышленного комплекса России , а также работаем в рамках 275 ФЗ с открытием отдельных счетов в уполномоченном банке. Система менеджмента качества компании соответствует требованиям ГОСТ ISO 9001.

Минимальные сроки поставки, гибкие цены, неограниченный ассортимент и индивидуальный подход к клиентам являются основой для выстраивания долгосрочного и эффективного сотрудничества с предприятиями радиоэлектронной промышленности, предприятиями ВПК и научно-исследовательскими институтами России.

С нами вы становитесь еще успешнее!

**Наши контакты:**

**Телефон:** +7 812 627 14 35

**Электронная почта:** [sales@st-electron.ru](mailto:sales@st-electron.ru)

**Адрес:** 198099, Санкт-Петербург,  
Промышленная ул, дом № 19, литера Н,  
помещение 100-Н Офис 331