



2M x 36, 2M x 32, 4M x 18 72 Mb SYNCHRONOUS PIPELINED, SINGLE CYCLE DESELECT STATIC RAM

APRIL 2015

FEATURES

- Internal self-timed write cycle
- Individual Byte Write Control and Global Write
- Clock controlled, registered address, data and control
- Burst sequence control using MODE input
- Three chip enable option for simple depth expansion and address pipelining
- Common data inputs and data outputs
- Auto Power-down during deselect
- Single cycle deselect
- Snooze MODE for reduced-power standby
- JTAG Boundary Scan for PBGA package
- Power Supply
LPS: V_{DD} 3.3V ($\pm 5\%$), V_{DDQ} 3.3V/2.5V ($\pm 5\%$)
VPS: V_{DD} 2.5V ($\pm 5\%$), V_{DDQ} 2.5V ($\pm 5\%$)
VVPS: V_{DD} 1.8V ($\pm 5\%$), V_{DDQ} 1.8V ($\pm 5\%$)
- JEDEC 100-Pin TQFP, 119-ball PBGA, and 165-ball PBGA packages
- Lead-free available

DESCRIPTION

The 72Mb product family features high-speed, low-power synchronous static RAMs designed to provide burstable, high-performance memory for communication and networking applications. The IS61LPS/VPS204836B and IS64LPS204836B are organized as 2,096,952 words by 36 bits. The IS61LPS204832B is organized as 2,096,952 words by 32 bits. The IS61LPS/VPS409618B is organized as 4,193,904 words by 18 bits. Fabricated with ISSI's advanced CMOS technology, the device integrates a 2-bit burst counter, high-speed SRAM core, and high-drive capability outputs into a single monolithic circuit. All synchronous inputs pass through registers controlled by a positive-edge-triggered single clock input.

Write cycles are internally self-timed and are initiated by the rising edge of the clock input. Write cycles can be one to four bytes wide as controlled by the write control inputs.

Separate byte enables allow individual bytes to be written. The byte write operation is performed by using the byte write enable (BWE) input combined with one or more individual byte write signals (BWx). In addition, Global Write (GW) is available for writing all bytes at one time, regardless of the byte write controls.

Bursts can be initiated with either \overline{ADSP} (Address Status Processor) or \overline{ADSC} (Address Status Cache Controller) input pins. Subsequent burst addresses can be generated internally and controlled by the \overline{ADV} (burst address advance) input pin.

The mode pin is used to select the burst sequence order, Linear burst is achieved when this pin is tied LOW. Interleave burst is achieved when this pin is tied HIGH or left floating.

FAST ACCESS TIME

Symbol	Parameter	250	200	166	Units
t_{KQ}	Clock Access Time	2.8	3.1	3.8	ns
t_{Kc}	Cycle Time	4	5	6	ns
	Frequency	250	200	166	MHz

Copyright © 2015 Integrated Silicon Solution, Inc. All rights reserved. ISSI reserves the right to make changes to this specification and its products at any time without notice. ISSI assumes no liability arising out of the application or use of any information, products or services described herein. Customers are advised to obtain the latest version of this device specification before relying on any published information and before placing orders for products.

Integrated Silicon Solution, Inc. does not recommend the use of any of its products in life support applications where the failure or malfunction of the product can reasonably be expected to cause failure of the life support system or to significantly affect its safety or effectiveness. Products are not authorized for use in such applications unless Integrated Silicon Solution, Inc. receives written assurance to its satisfaction, that:

- a.) the risk of injury or damage has been minimized;
- b.) the user assume all such risks; and
- c.) potential liability of Integrated Silicon Solution, Inc is adequately protected under the circumstances

BLOCK DIAGRAM

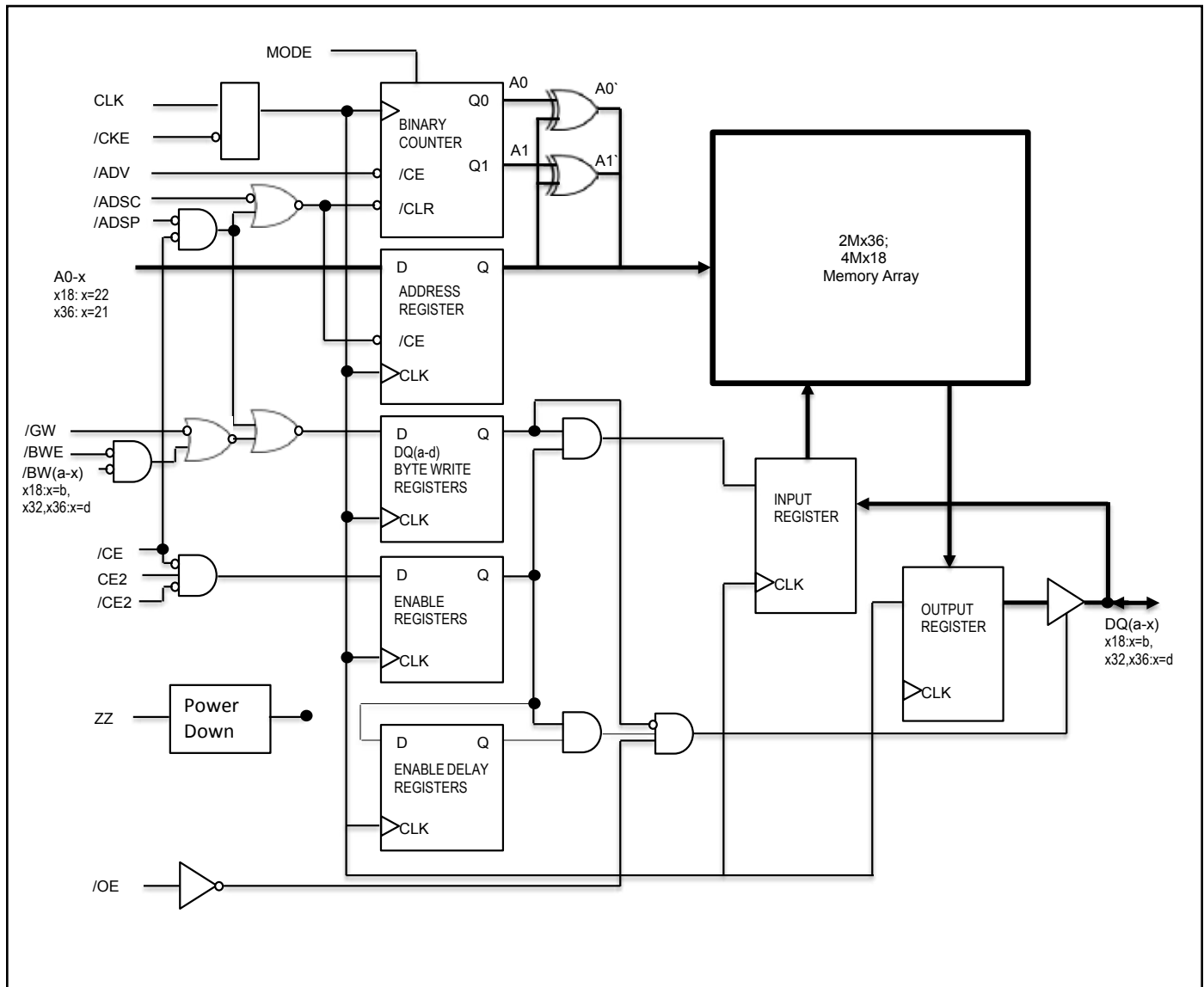

165-PIN Bg A

165-Ball, 13x15 mm BGA
165-Ball, 15x17 mm BGA
1mm Ball Pitch, 11x15 Ball Array

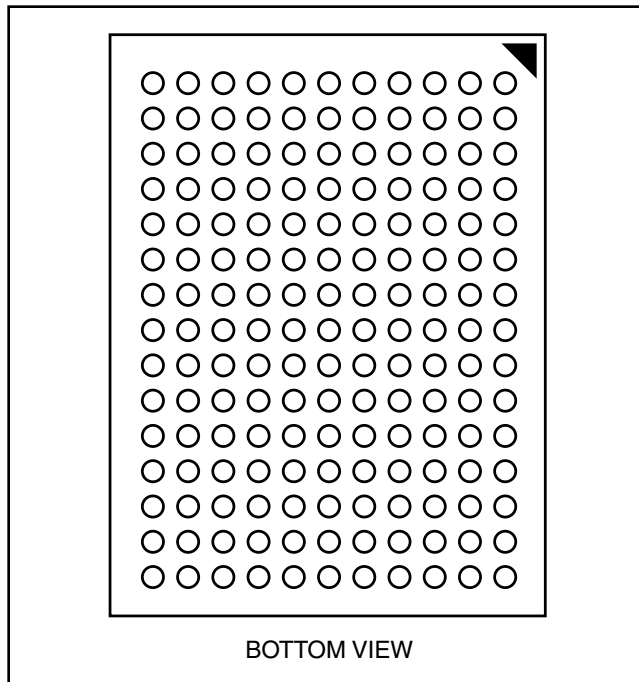

119-PIN Bg A

119-Ball, 14x22 mm BGA
1.27mm Ball Pitch, 7x17 Ball Array

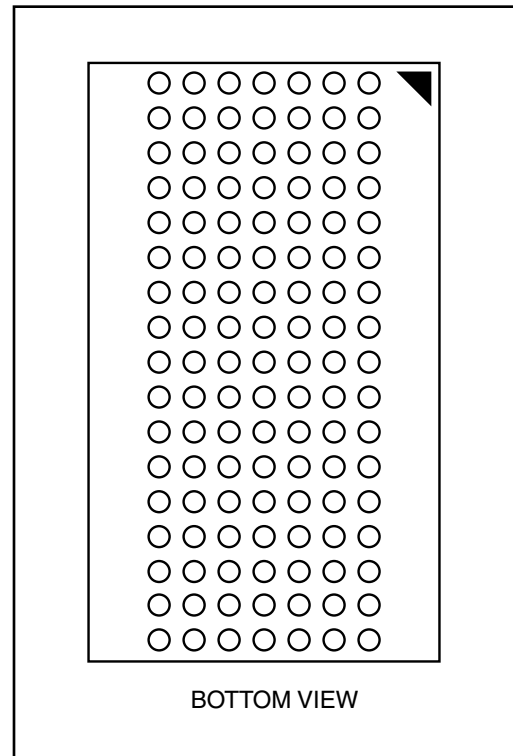

119 BGA PACKAGE PIN CONFIGURATION-2M x 36 (TOP VIEW)

	1	2	3	4	5	6	7
A	V _{DDQ}	A	A	$\overline{\text{ADSP}}$	A	A	V _{DDQ}
B	NC	A	A	$\overline{\text{ADSC}}$	A	A	NC
C	NC	A	A	V _{DD}	A	A	NC
D	DQc	DQPc	V _{SS}	NC	V _{SS}	DQPb	DQb
E	DQc	DQc	V _{SS}	$\overline{\text{CE}}$	V _{SS}	DQb	DQb
F	V _{DDQ}	DQc	V _{SS}	$\overline{\text{OE}}$	V _{SS}	DQb	V _{DDQ}
g	DQc	DQc	$\overline{\text{BWc}}$	$\overline{\text{ADV}}$	$\overline{\text{BWb}}$	DQb	DQb
H	DQc	DQc	V _{SS}	$\overline{\text{GW}}$	V _{SS}	DQb	DQb
J	V _{DDQ}	V _{DD}	NC	V _{DD}	NC	V _{DD}	V _{DDQ}
K	DQd	DQd	V _{SS}	CLK	V _{SS}	DQa	DQa
L	DQd	DQd	$\overline{\text{BWd}}$	NC	$\overline{\text{BWa}}$	DQa	DQa
M	V _{DDQ}	DQd	V _{SS}	$\overline{\text{BWE}}$	V _{SS}	DQa	V _{DDQ}
N	DQd	DQd	V _{SS}	A ₁ *	V _{SS}	DQa	DQa
P	DQd	DQPd	V _{SS}	A ₀ *	V _{SS}	DQPd	DQa
R	NC	A	MODE	V _{DD}	NC	A	NC
T	NC	A	A	A	A	A	ZZ
U	V _{DDQ}	TMS	TDI	TCK	TDO	NC	V _{DDQ}

Note: * A₀ and A₁ are the two least significant bits (LSB) of the address field and set the internal burst counter if burst is desired.

PIN DESCRIPTIONS

Symbol	Pin Name
A	Synchronous Address Inputs
A0, A1	Synchronous Burst Address Inputs
$\overline{\text{ADV}}$	Synchronous Burst Address Advance
$\overline{\text{ADSP}}$	Synchronous Address Status Processor
$\overline{\text{ADSC}}$	Synchronous Address Status Controller
$\overline{\text{GW}}$	Synchronous Global Write Enable
CLK	Synchronous Clock
$\overline{\text{CE}}, \text{CE2}$	Synchronous Chip Select
$\overline{\text{BWa}}\text{-}\overline{\text{BWd}}$	Synchronous Byte Write Controls
$\overline{\text{BWE}}$	Synchronous Byte Write Enable

Symbol	Pin Name
$\overline{\text{OE}}$	Asynchronous Output Enable
ZZ	Asynchronous Power Sleep Mode
MODE	Burst Sequence Selection
TCK, TDO	JTAG Pins
TMS, TDI	
NC	No Connect
DQa-DQd	Synchronous Data Inputs/Outputs
DQPd-DQPd	Synchronous Parity Data Inputs/Outputs
V _{DD}	Power Supply
V _{DDQ}	I/O Power Supply
V _{SS}	Ground

119 BGA PACKAGE PIN CONFIGURATION

4Mx18 (TOP VIEW)

	1	2	3	4	5	6	7
A	V _{DDQ}	A	A	$\overline{\text{ADSP}}$	A	A	V _{DDQ}
B	NC	A	A	$\overline{\text{ADSC}}$	A	A	NC
C	NC	A	A	V _{DD}	A	A	NC
D	DQb	NC	V _{SS}	NC	V _{SS}	DQP _a	NC
E	NC	DQb	V _{SS}	$\overline{\text{CE}}$	V _{SS}	NC	DQ _a
F	V _{DDQ}	NC	V _{SS}	$\overline{\text{OE}}$	V _{SS}	DQ _a	V _{DDQ}
g	NC	DQb	$\overline{\text{BWB}}$	$\overline{\text{ADV}}$	V _{SS}	NC	DQ _a
H	DQb	NC	V _{SS}	$\overline{\text{GW}}$	V _{SS}	DQ _a	NC
J	V _{DDQ}	V _{DD}	NC	V _{DD}	NC	V _{DD}	V _{DDQ}
K	NC	DQb	V _{SS}	CLK	V _{SS}	NC	DQ _a
L	DQb	NC	V _{SS}	NC	$\overline{\text{BWA}}$	DQ _a	NC
M	V _{DDQ}	DQb	V _{SS}	$\overline{\text{BWE}}$	V _{SS}	NC	V _{DDQ}
N	DQb	NC	V _{SS}	A ₁ *	V _{SS}	DQ _a	NC
P	NC	DQP _b	V _{SS}	A ₀ *	V _{SS}	NC	DQ _a
R	NC	A	MODE	V _{DD}	NC	A	NC
T	A	A	A	A	A	A	ZZ
U	V _{DDQ}	TMS	TDI	TCK	TDO	NC	V _{DDQ}

Note: * A₀ and A₁ are the two least significant bits (LSB) of the address field and set the internal burst counter if burst is desired.

PIN DESCRIPTIONS

Symbol	Pin Name
A	Synchronous Address Inputs
A ₀ , A ₁	Synchronous Burst Address Inputs
$\overline{\text{ADV}}$	Synchronous Burst Address Advance
$\overline{\text{ADSP}}$	Synchronous Address Status Processor
$\overline{\text{ADSC}}$	Synchronous Address Status Controller
$\overline{\text{GW}}$	Synchronous Global Write Enable
CLK	Synchronous Clock
$\overline{\text{CE}}$, CE ₂	Synchronous Chip Select
$\overline{\text{BWA}}$ - $\overline{\text{BWB}}$	Synchronous Byte Write Controls
$\overline{\text{BWE}}$	Synchronous Byte Write Enable

Symbol	Pin Name
$\overline{\text{OE}}$	Asynchronous Output Enable
ZZ	Asynchronous Power Sleep Mode
MODE	Burst Sequence Selection
TCK, TDO	JTAG Pins
TMS, TDI	
NC	No Connect
DQ _a -DQ _b	Synchronous Data Inputs/Outputs
DQP _a -DQP _b	Synchronous Parity Data Inputs/Outputs
V _{DD}	Power Supply
V _{DDQ}	I/O Power Supply
V _{SS}	Ground



165 PBGA PACKAGE PIN CONFIGURATION

2M x 36 (TOP VIEW)

	1	2	3	4	5	6	7	8	9	10	11
A	NC	A	\overline{CE}	\overline{BWc}	\overline{BWb}	$\overline{CE2}$	\overline{BWE}	\overline{ADSC}	\overline{ADV}	A	NC
B	NC	A	CE2	\overline{BWd}	\overline{BWA}	CLK	\overline{GW}	\overline{OE}	\overline{ADSP}	A	NC
C	DQPc	NC	VDDQ	VSS	VSS	VSS	VSS	VSS	VDDQ	NC	DQPb
D	DQc	DQc	VDDQ	VDD	VSS	VSS	VSS	VDD	VDDQ	DQb	DQb
E	DQc	DQc	VDDQ	VDD	VSS	VSS	VSS	VDD	VDDQ	DQb	DQb
F	DQc	DQc	VDDQ	VDD	VSS	VSS	VSS	VDD	VDDQ	DQb	DQb
g	DQc	DQc	VDDQ	VDD	VSS	VSS	VSS	VDD	VDDQ	DQb	DQb
H	NC	NC	NC	VDD	VSS	VSS	VSS	VDD	NC	NC	ZZ
J	DQd	DQd	VDDQ	VDD	VSS	VSS	VSS	VDD	VDDQ	DQa	DQa
K	DQd	DQd	VDDQ	VDD	VSS	VSS	VSS	VDD	VDDQ	DQa	DQa
L	DQd	DQd	VDDQ	VDD	VSS	VSS	VSS	VDD	VDDQ	DQa	DQa
M	DQd	DQd	VDDQ	VDD	VSS	VSS	VSS	VDD	VDDQ	DQa	DQa
N	DQPd	NC	VDDQ	VSS	NC	A	NC	VSS	VDDQ	NC	DQPd
P	NC	A	A	A	TDI	A1*	TDO	A	A	A	A
R	MODE	A	A	A	TMS	A0*	TCK	A	A	A	A

Note: * A0 and A1 are the two least significant bits (LSB) of the address field and set the internal burst counter if burst is desired.

PIN DESCRIPTIONS

Symbol	Pin Name
A	Synchronous Address Inputs
A0, A1	Synchronous Burst Address Inputs
\overline{ADV}	Synchronous Burst Address Advance
\overline{ADSP}	Synchronous Address Status Processor
\overline{ADSC}	Synchronous Address Status Controller
\overline{GW}	Synchronous Global Write Enable
CLK	Synchronous Clock
\overline{CE} , $\overline{CE2}$, CE2	Synchronous Chip Select
\overline{BWA} - \overline{BWd}	Synchronous Byte Write Controls

Symbol	Pin Name
\overline{BWE}	Synchronous Byte Write Enable
\overline{OE}	Asynchronous Output Enable
ZZ	Asynchronous Power Sleep Mode
MODE	Burst Sequence Selection
TCK, TDO TMS, TDI	JTAG Pins
NC	No Connect
DQa-DQd	Synchronous Data Inputs/Outputs
DQPd-DQPa	Synchronous Parity Data Inputs/Outputs
VDD	Power Supply
VDDQ	I/O Power Supply
VSS	Ground

165 PBGA PACKAGE PIN CONFIGURATION

4M x 18 (TOP VIEW)

	1	2	3	4	5	6	7	8	9	10	11
A	NC	A	\overline{CE}	\overline{BWb}	NC	$\overline{CE2}$	\overline{BWE}	\overline{ADSC}	\overline{ADV}	A	A
B	NC	A	CE2	NC	\overline{BWa}	CLK	\overline{GW}	\overline{OE}	\overline{ADSP}	A	NC
C	NC	NC	V _{DDQ}	V _{SS}	V _{SS}	V _{SS}	V _{SS}	V _{SS}	V _{DDQ}	NC	DQP _a
D	NC	DQ _b	V _{DDQ}	V _{DD}	V _{SS}	V _{SS}	V _{SS}	V _{DD}	V _{DDQ}	NC	DQ _a
E	NC	DQ _b	V _{DDQ}	V _{DD}	V _{SS}	V _{SS}	V _{SS}	V _{DD}	V _{DDQ}	NC	DQ _a
F	NC	DQ _b	V _{DDQ}	V _{DD}	V _{SS}	V _{SS}	V _{SS}	V _{DD}	V _{DDQ}	NC	DQ _a
g	NC	DQ _b	V _{DDQ}	V _{DD}	V _{SS}	V _{SS}	V _{SS}	V _{DD}	V _{DDQ}	NC	DQ _a
H	NC	NC	NC	V _{DD}	V _{SS}	V _{SS}	V _{SS}	V _{DD}	NC	NC	ZZ
J	DQ _b	NC	V _{DDQ}	V _{DD}	V _{SS}	V _{SS}	V _{SS}	V _{DD}	V _{DDQ}	DQ _a	NC
K	DQ _b	NC	V _{DDQ}	V _{DD}	V _{SS}	V _{SS}	V _{SS}	V _{DD}	V _{DDQ}	DQ _a	NC
L	DQ _b	NC	V _{DDQ}	V _{DD}	V _{SS}	V _{SS}	V _{SS}	V _{DD}	V _{DDQ}	DQ _a	NC
M	DQ _b	NC	V _{DDQ}	V _{DD}	V _{SS}	V _{SS}	V _{SS}	V _{DD}	V _{DDQ}	DQ _a	NC
N	DQP _b	NC	V _{DDQ}	V _{SS}	NC	A	NC	V _{SS}	V _{DDQ}	NC	NC
P	NC	A	A	A	TDI	A1*	TDO	A	A	A	A
R	MODE	A	A	A	TMS	A0*	TCK	A	A	A	A

Note: * A₀ and A₁ are the two least significant bits (LSB) of the address field and set the internal burst counter if burst is desired.

PIN DESCRIPTIONS

Symbol	Pin Name
A	Synchronous Address Inputs
A0, A1	Synchronous Burst Address Inputs
\overline{ADV}	Synchronous Burst Address Advance
\overline{ADSP}	Synchronous Address Status Processor
\overline{ADSC}	Synchronous Address Status Controller
\overline{GW}	Synchronous Global Write Enable
CLK	Synchronous Clock
\overline{CE} , $\overline{CE2}$, CE2	Synchronous Chip Select
\overline{BWa} - \overline{BWb}	Synchronous Byte Write Controls

Symbol	Pin Name
\overline{BWE}	Synchronous Byte Write Enable
\overline{OE}	Asynchronous Output Enable
ZZ	Asynchronous Power Sleep Mode
MODE	Burst Sequence Selection
TCK, TDO TMS, TDI	JTAG Pins
NC	No Connect
DQ _a -DQ _b	Synchronous Data Inputs/Outputs
DQP _a -DQP _b	Synchronous Parity Data Inputs/Outputs
V _{DD}	3.3V/2.5V Power Supply
V _{DDQ}	I/O Power Supply
V _{SS}	Ground

PIN CONFIGURATION

100-PIN TQFP (2M x 36)

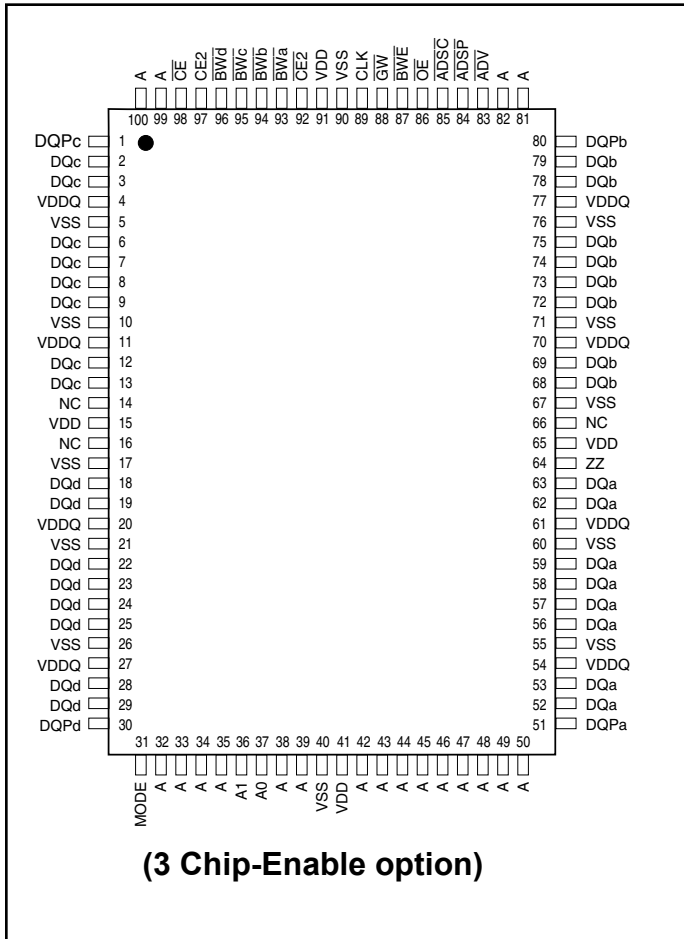

PIN DESCRIPTIONS

A0, A1	Synchronous Address Inputs. These pins must tied to the two LSBs of the address bus.
A	Synchronous Address Inputs
$\overline{\text{ADSC}}$	Synchronous Controller Address Status
$\overline{\text{ADSP}}$	Synchronous Processor Address Status
$\overline{\text{ADV}}$	Synchronous Burst Address Advance
$\overline{\text{BWA}}$ - $\overline{\text{BWD}}$	Synchronous Byte Write Enable
$\overline{\text{BWE}}$	Synchronous Byte Write Enable
$\overline{\text{CE}}$, $\overline{\text{CE2}}$, $\overline{\text{CE2}}$	Synchronous Chip Enable
CLK	Synchronous Clock

DQa-DQd	Synchronous Data Inputs/Outputs
DQPa-DQPd	Synchronous Parity Data Inputs/Outputs
$\overline{\text{GW}}$	Synchronous Global Write Enable
MODE	Burst Sequence Mode Selection
$\overline{\text{OE}}$	Asynchronous Output Enable
VDD	Power Supply
VDDQ	I/O Power Supply
VSS	Ground
ZZ	Asynchronous Snooze Enable

PIN CONFIGURATION

100-PIN TQFP (2M x 32)

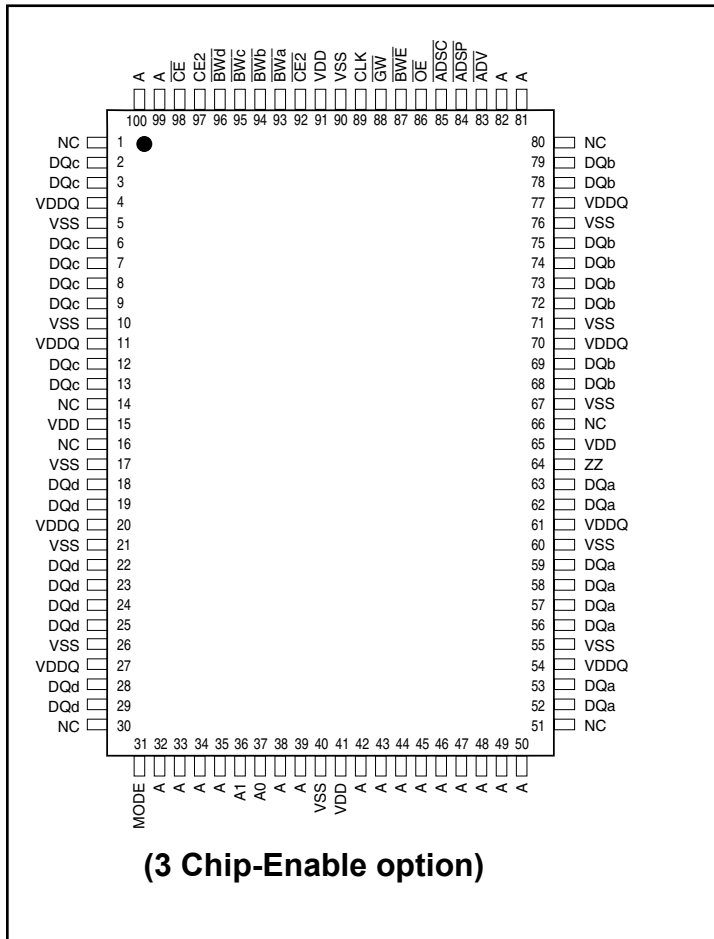

PIN DESCRIPTIONS

A0, A1	Synchronous Address Inputs. These pins must tied to the two LSBs of the address bus.
A	Synchronous Address Inputs
\overline{ADSC}	Synchronous Controller Address Status
\overline{ADSP}	Synchronous Processor Address Status
\overline{ADV}	Synchronous Burst Address Advance
\overline{BWA} - \overline{BWD}	Synchronous Byte Write Enable
\overline{BWE}	Synchronous Byte Write Enable
\overline{CE} , $\overline{CE2}$, CE2	Synchronous Chip Enable
CLK	Synchronous Clock

DQa-DQd	Synchronous Data Inputs/Outputs
\overline{GW}	Synchronous Global Write Enable
MODE	Burst Sequence Mode Selection
\overline{OE}	Asynchronous Output Enable
V _{DD}	Power Supply
V _{DDQ}	I/O Power Supply
V _{SS}	Ground
ZZ	Asynchronous Snooze Enable

TRUTH TABLE⁽¹⁻⁸⁾

OPERATION	ADDRESS	\overline{CE}	$\overline{CE2}$	CE2	ZZ	\overline{ADSP}	\overline{ADSC}	\overline{ADV}	\overline{WRITE}	\overline{OE}	CLK	DQ
Deselect Cycle, Power-Down	None	H	X	X	L	X	L	X	X	X	L-H	High-Z
Deselect Cycle, Power-Down	None	L	X	L	L	L	X	X	X	X	L-H	High-Z
Deselect Cycle, Power-Down	None	L	H	X	L	L	X	X	X	X	L-H	High-Z
Deselect Cycle, Power-Down	None	L	X	L	L	H	L	X	X	X	L-H	High-Z
Deselect Cycle, Power-Down	None	L	H	X	L	H	L	X	X	X	L-H	High-Z
Snooze Mode, Power-Down	None	X	X	X	H	X	X	X	X	X	X	High-Z
Read Cycle, Begin Burst	External	L	L	H	L	L	X	X	X	L	L-H	Q
Read Cycle, Begin Burst	External	L	L	H	L	L	X	X	X	H	L-H	High-Z
Write Cycle, Begin Burst	External	L	L	H	L	H	L	X	L	X	L-H	D
Read Cycle, Begin Burst	External	L	L	H	L	H	L	X	H	L	L-H	Q
Read Cycle, Begin Burst	External	L	L	H	L	H	L	X	H	H	L-H	High-Z
Read Cycle, Continue Burst	Next	X	X	X	L	H	H	L	H	L	L-H	Q
Read Cycle, Continue Burst	Next	X	X	X	L	H	H	L	H	H	L-H	High-Z
Read Cycle, Continue Burst	Next	H	X	X	L	X	H	L	H	L	L-H	Q
Read Cycle, Continue Burst	Next	H	X	X	L	X	H	L	H	H	L-H	High-Z
Write Cycle, Continue Burst	Next	X	X	X	L	H	H	L	L	X	L-H	D
Write Cycle, Continue Burst	Next	H	X	X	L	X	H	L	L	X	L-H	D
Read Cycle, Suspend Burst	Current	X	X	X	L	H	H	H	H	L	L-H	Q
Read Cycle, Suspend Burst	Current	X	X	X	L	H	H	H	H	H	L-H	High-Z
Read Cycle, Suspend Burst	Current	H	X	X	L	X	H	H	H	L	L-H	Q
Read Cycle, Suspend Burst	Current	H	X	X	L	X	H	H	H	H	L-H	High-Z
Write Cycle, Suspend Burst	Current	X	X	X	L	H	H	H	L	X	L-H	D
Write Cycle, Suspend Burst	Current	H	X	X	L	X	H	H	L	X	L-H	D

NOTE:

1. X means "Don't Care." H means logic HIGH. L means logic LOW.
2. For \overline{WRITE} , L means one or more byte write enable signals ($\overline{BWA-d}$) and \overline{BWE} are LOW or \overline{GW} is LOW. $\overline{WRITE} = H$ for all \overline{BWx} , \overline{BWE} , \overline{GW} HIGH.
3. \overline{BWA} enables \overline{WRITE} s to DQa 's and DQP_a . \overline{BWb} enables \overline{WRITE} s to DQb 's and DQP_b . \overline{BWC} enables \overline{WRITE} s to DQc 's and DQP_c . \overline{BWD} enables \overline{WRITE} s to DQd 's and DQP_d . DQP_a and DQP_b are available on the x18 version. DQP_a - DQP_d are available on the x36 version.
4. All inputs except \overline{OE} and ZZ must meet setup and hold times around the rising edge (LOW to HIGH) of CLK.
5. Wait states are inserted by suspending burst.
6. For a \overline{WRITE} operation following a \overline{READ} operation, \overline{OE} must be HIGH before the input data setup time and held HIGH during the input data hold time.
7. This device contains circuitry that will ensure the outputs will be in High-Z during power-up.
8. \overline{ADSP} LOW always initiates an internal \overline{READ} at the L-H edge of CLK. A \overline{WRITE} is performed by setting one or more byte write enable signals and \overline{BWE} LOW or \overline{GW} LOW for the subsequent L-H edge of CLK. See \overline{WRITE} timing diagram for clarification.

PARTIAL TRUTH TABLE

Function	\overline{GW}	\overline{BWE}	\overline{BWA}	\overline{BWb}	\overline{BWC}	\overline{BWD}
Read	H	H	X	X	X	X
Read	H	L	H	H	H	H
Write Byte 1	H	L	L	H	H	H
Write All Bytes	H	L	L	L	L	L
Write All Bytes	L	X	X	X	X	X

POWER UP SEQUENCE

$V_{DDQ} \rightarrow V_{DD}^1 \rightarrow I/O \text{ Pins}^2$

Notes:

- V_{DD} can be applied at the same time as V_{DDQ}
- Applying I/O inputs is recommended after V_{DDQ} is ready. The inputs of the I/O pins can be applied at the same time as V_{DDQ} provided V_{IH} (level of I/O pins) is lower than V_{DDQ} .

POWER-UP INITIALIZATION TIMING

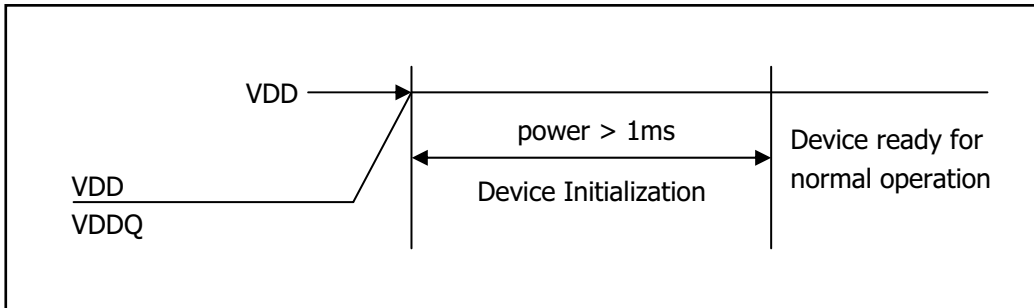

INTERLEAVED BURST ADDRESS TABLE (MODE = V_{DD} or No Connect)

External Address	1st Burst Address	2nd Burst Address	3rd Burst Address
A1 A0	A1 A0	A1 A0	A1 A0
00	01	10	11
01	00	11	10
10	11	00	01
11	10	01	00

LINEAR BURST ADDRESS TABLE (MODE = VSS)

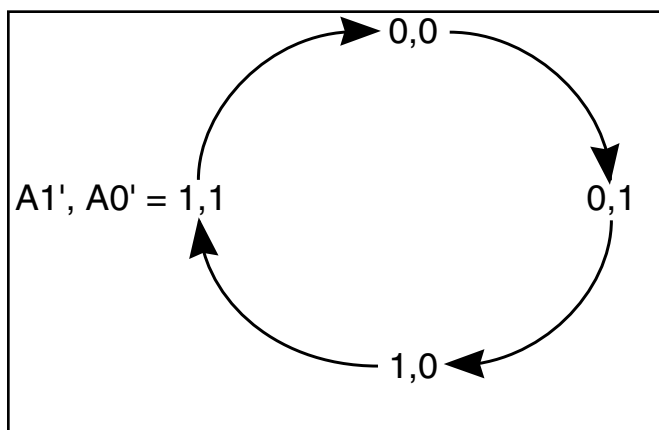

ABSOLUTE MAXIMUM RATINGS⁽¹⁾

Symbol	Parameter	LPS Value	VPS/VVPS Value	Unit
T _{STG}	Storage Temperature	-55 to +150	-55 to +150	°C
P _D	Power Dissipation	1.6	1.6	W
I _{OUT}	Output Current (per I/O)	100	100	mA
V _{IN} , V _{OUT}	Voltage Relative to V _{SS} for I/O Pins	-0.5 to V _{DDQ} + 0.5	-0.5 to V _{DDQ} + 0.3	V
V _{IN}	Voltage Relative to V _{SS} for for Address and Control Inputs	-0.5 to V _{DD} + 0.5	-0.5 to V _{DD} + 0.3	V
V _{DD}	Voltage on V _{DD} Supply Relative to V _{SS}	-0.5 to V _{DDQ} + 0.5	-0.3 to V _{DDQ} + 0.3	V

Notes:

1. Stress greater than those listed under ABSOLUTE MAXIMUM RATINGS may cause permanent damage to the device. This is a stress rating only and functional operation of the device at these or any other conditions above those indicated in the operational sections of this specification is not implied. Exposure to absolute maximum rating conditions for extended periods may affect reliability.
2. This device contains circuitry to protect the inputs against damage due to high static voltages or electric fields; however, precautions may be taken to avoid application of any voltage higher than maximum rated voltages to this high-impedance circuit.
3. This device contains circuitry that will ensure the output devices are in High-Z at power up.

OPERATING RANGE (IS61LPSXXXXX)

Range	Ambient Temperature	V _{DD}	V _{DDQ}
Commercial	0°C to +70°C	3.3V ± 5%	3.3V / 2.5V ± 5%
Industrial	-40°C to +85°C	3.3V ± 5%	3.3V / 2.5V ± 5%

OPERATING RANGE (IS61VPSXXXXX)

Range	Ambient Temperature	V _{DD}	V _{DDQ}
Commercial	0°C to +70°C	2.5V ± 5%	2.5V ± 5%
Industrial	-40°C to +85°C	2.5V ± 5%	2.5V ± 5%

OPERATING RANGE (IS61VVPSXXXXX)

Range	Ambient Temperature	V _{DD}	V _{DDQ}
Commercial	0°C to +70°C	1.8V ± 5%	1.8V ± 5%
Industrial	-40°C to +85°C	1.8V ± 5%	1.8V ± 5%

OPERATING RANGE (IS64LPSXXXXX)

Range	Ambient Temperature	V _{DD}	V _{DDQ}
Automotive	-40°C to +125°C	3.3V ± 5%	3.3V / 2.5V ± 5%

DC ELECTRICAL CHARACTERISTICS (Over Operating Range) ^{1, 2, 3}

Symbol	Parameter	Test Conditions	3.3V		2.5V		1.8V		Unit
			Min.	Max.	Min.	Max.	Min.	Max.	
V _{OH}	Output HIGH Voltage	I _{OH} = -4.0 mA (3.3V) I _{OH} = -1.0 mA (2.5V, 1.8V)	2.4	—	2.0	—	V _{DDQ} - 0.4	—	V
V _{OL}	Output LOW Voltage	I _{OL} = 8.0 mA (3.3V) I _{OL} = 1.0 mA (2.5V, 1.8V)	—	0.4	—	0.4	—	0.4	V
V _{IH}	Input HIGH Voltage		2.0	V _{DD} + 0.3	1.7	V _{DD} + 0.3	0.6V _{DD}	V _{DD} + 0.3	V
V _{IL}	Input LOW Voltage		-0.3	0.8	-0.3	0.7	-0.3	0.3V _{DD}	V
I _{LI}	Input Leakage Current	V _{SS} ≤ V _{IN} ≤ V _{DD} ^(1,4)	-5	5	-5	5	-5	5	μA
	Input Current of MODE	V _{SS} ≤ V _{IN} ≤ V _{DD} ⁽⁵⁾	-30	5	-30	5	-30	5	
	Input Current of ZZ	V _{SS} ≤ V _{IN} ≤ V _{DD} ⁽⁶⁾	-5	30	-5	30	-5	30	
I _{LO}	Output Leakage Current	V _{SS} ≤ V _{OUT} ≤ V _{DDQ} , OE = V _{IH}	-5	5	-5	5	-5	5	μA

Notes:

- All voltages referenced to ground.
- Overshoot:
3.3V and 2.5V: V_{IH} (AC) ≤ V_{DD} + 1.5V (Pulse width less than t_{KC} / 2)
1.8V: V_{IH} (AC) ≤ V_{DD} + 0.5V (Pulse width less than t_{KC} / 2)
- Undershoot:
3.3V and 2.5V: V_{IL} (AC) ≥ -1.5V (Pulse width less than t_{KC} / 2)
1.8V: V_{IL} (AC) ≥ -0.5V (Pulse width less than t_{KC} / 2)
- Except MODE and ZZ
- MODE is connected to pull-up resistor internally.
- ZZ is connected to pull-down resistor internally.

POWER SUPPLY CHARACTERISTICS⁽¹⁾ (Over Operating Range)

Symbol	Parameter	Test Conditions	Temp. range	-250 MAX		-200 MAX		Unit
				x18	x36	x18	x36	
I _{CC}	AC Operating Supply Current	Device Selected,	Com.	450	450	400	400	mA
		OE = V _{IH} , ZZ ≤ V _{IL} ,	Ind.	500	500	450	450	
		All Inputs ≤ 0.2V or ≥ V _{DD} - 0.2V, Auto. Cycle Time ≥ t _{KC} min.		-	-	550	550	
I _{SB}	Standby Current TTL Input	Device Deselected,	Com.	200	200	200	200	mA
		V _{DD} = Max.,	Ind.	220	220	220	220	
		All Inputs ≤ V _{IL} or ≥ V _{IH} , ZZ ≤ V _{IL} , f = Max.	Auto.	-	-	350	350	
I _{SBI}	Standby Current CMOS Input	Device Deselected,	Com.	180	180	180	180	mA
		V _{DD} = Max.,	Ind.	200	200	200	200	
		V _{IN} ≤ V _{SS} + 0.2V or ≥ V _{DD} - 0.2V f = 0	Auto.	-	-	320	320	

CAPACITANCE^(1,2)

Symbol	Parameter	Conditions	Max.	Unit
C _{IN}	Input Capacitance	V _{IN} = 0V	6	pF
C _{OUT}	Input/Output Capacitance	V _{OUT} = 0V	8	pF

Notes:

1. Tested initially and after any design or process changes that may affect these parameters.
2. Test conditions: T_A = 25°C, f = 1 MHz, V_{DD} = 3.3V.

3.3V I/O AC TEST CONDITIONS

Parameter	Unit
Input Pulse Level	0V to 3.0V
Input Rise and Fall Times	1.5 ns
Input and Output Timing and Reference Level	1.5V
Output Load	See Figures 1 and 2

AC TEST LOADS

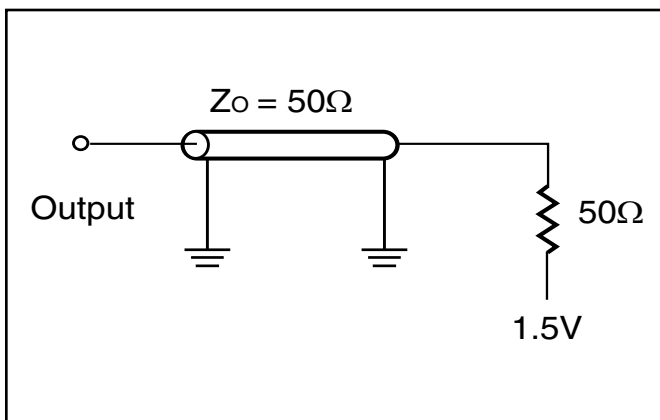

Figure 1

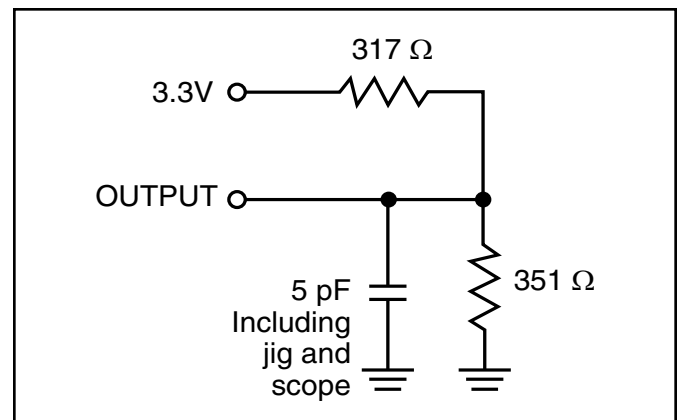

Figure 2

2.5V I/O AC TEST CONDITIONS

Parameter	Unit
Input Pulse Level	0V to 2.5V
Input Rise and Fall Times	1.5 ns
Input and Output Timing and Reference Level	1.25V
Output Load	See Figures 3 and 4

2.5 I/O OUTPUT LOAD EQUIVALENT

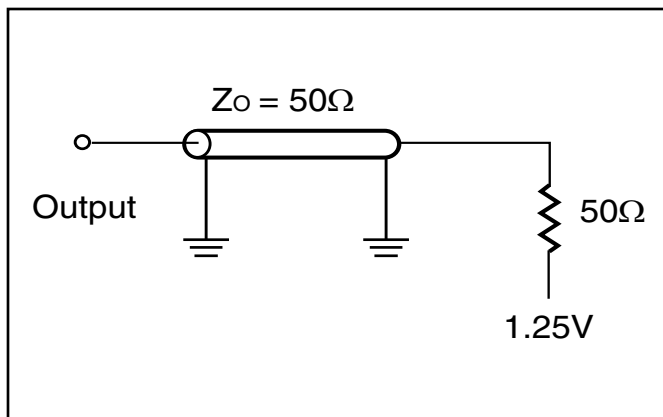

Figure 3

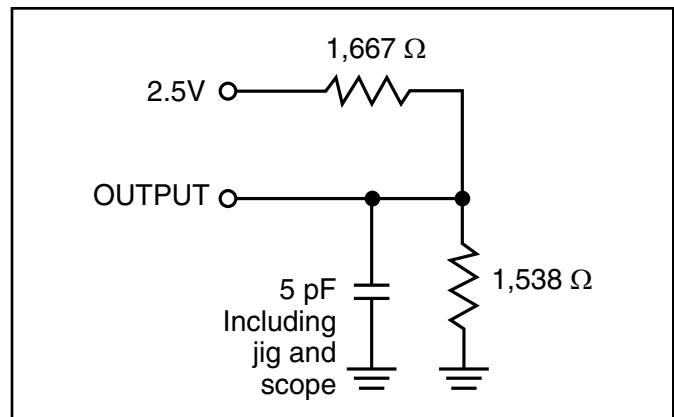

Figure 4

1.8V I/O AC TEST CONDITIONS

Parameter	Unit
Input Pulse Level	0V to 1.8V
Input Rise and Fall Times	1.5 ns
Input and Output Timing and Reference Level	0.9V
Output Load	See Figures 5 and 6

1.8 I/O OUTPUT LOAD EQUIVALENT

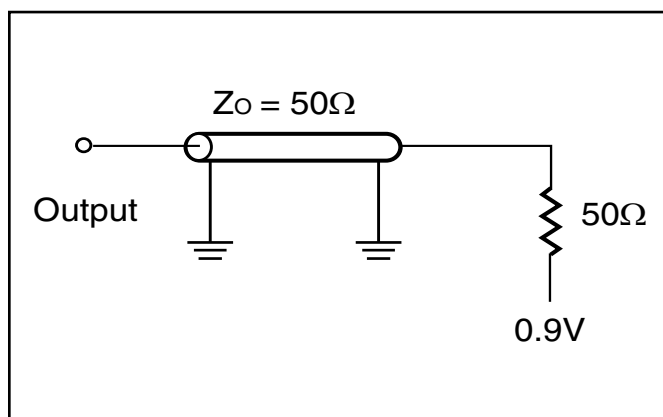

Figure 5

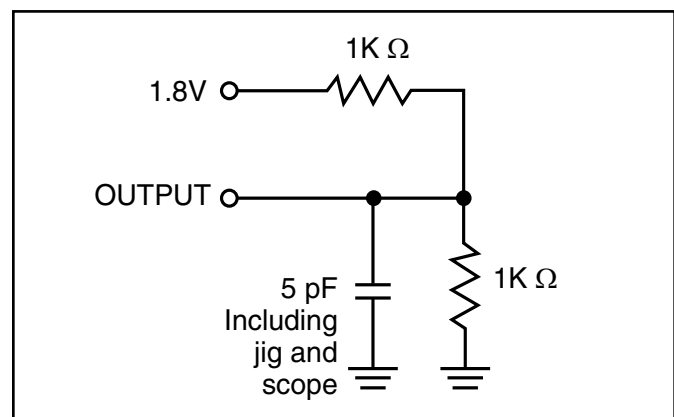

Figure 6

READ/wRITE CYCLE SWITCHING CHARACTERISTICS (Over Operating Range)

Symbol	Parameter	-250		-200		-166		Unit
		Min.	Max.	Min.	Max.	Min.	Max.	
f _{MAX}	Clock Frequency	—	250	—	200	—	166	MHz
t _{KC}	Cycle Time	4.0	—	5	—	6	—	ns
t _{KH}	Clock High Time	1.7	—	2	—	2.4	—	ns
t _{KL}	Clock Low Time	1.7	—	2	—	2.3	—	ns
t _{KQ}	Clock Access Time	—	2.8	—	3.1	—	3.8	ns
t _{KQX} ⁽²⁾	Clock High to Output Invalid	0.8	—	1.5	—	1.5	—	ns
t _{KQLZ} ^(2,3)	Clock High to Output Low-Z	0.8	—	1	—	1.5	—	ns
t _{KQHZ} ^(2,3)	Clock High to Output High-Z	—	2.8	—	3.1	3.8	—	ns
t _{OEQ}	Output Enable to Output Valid	—	2.8	—	3.1	3.8	—	ns
t _{OE LZ} ^(2,3)	Output Enable to Output Low-Z	0	—	0	—	0	—	ns
t _{OE HZ} ^(2,3)	Output Disable to Output High-Z	—	2.8	—	3.1	3.8	—	ns
t _{AS}	Address Setup Time	1.4	—	1.4	—	1.5	—	ns
t _{WS}	Read/Write Setup Time	1.4	—	1.4	—	1.5	—	ns
t _{CES}	Chip Enable Setup Time	1.4	—	1.4	—	1.5	—	ns
t _{AVS}	Address Advance Setup Time	1.4	—	1.4	—	1.5	—	ns
t _{DS}	Data Setup Time	1.4	—	1.4	—	1.5	—	ns
t _{AH}	Address Hold Time	0.4	—	0.4	—	0.5	—	ns
t _{WH}	Write Hold Time	0.4	—	0.4	—	0.5	—	ns
t _{CEH}	Chip Enable Hold Time	0.4	—	0.4	—	0.5	—	ns
t _{AVH}	Address Advance Hold Time	0.4	—	0.4	—	0.5	—	ns
t _{DH}	Data Hold Time	0.4	—	0.4	—	0.5	—	ns
t _{POWER} ⁽⁴⁾	V _{DD} (typical) to First Access	1	—	1	—	1	—	ms

Note:

1. Configuration signal MODE is static and must not change during normal operation.
2. Guaranteed but not 100% tested. This parameter is periodically sampled.
3. Tested with load in Figure 2.
4. t_{POWER} is the time that the power needs to be supplied above V_{DD} (min) initially before READ or WRITE operation can be initiated.

READ/wRITE CYCLE TIMING

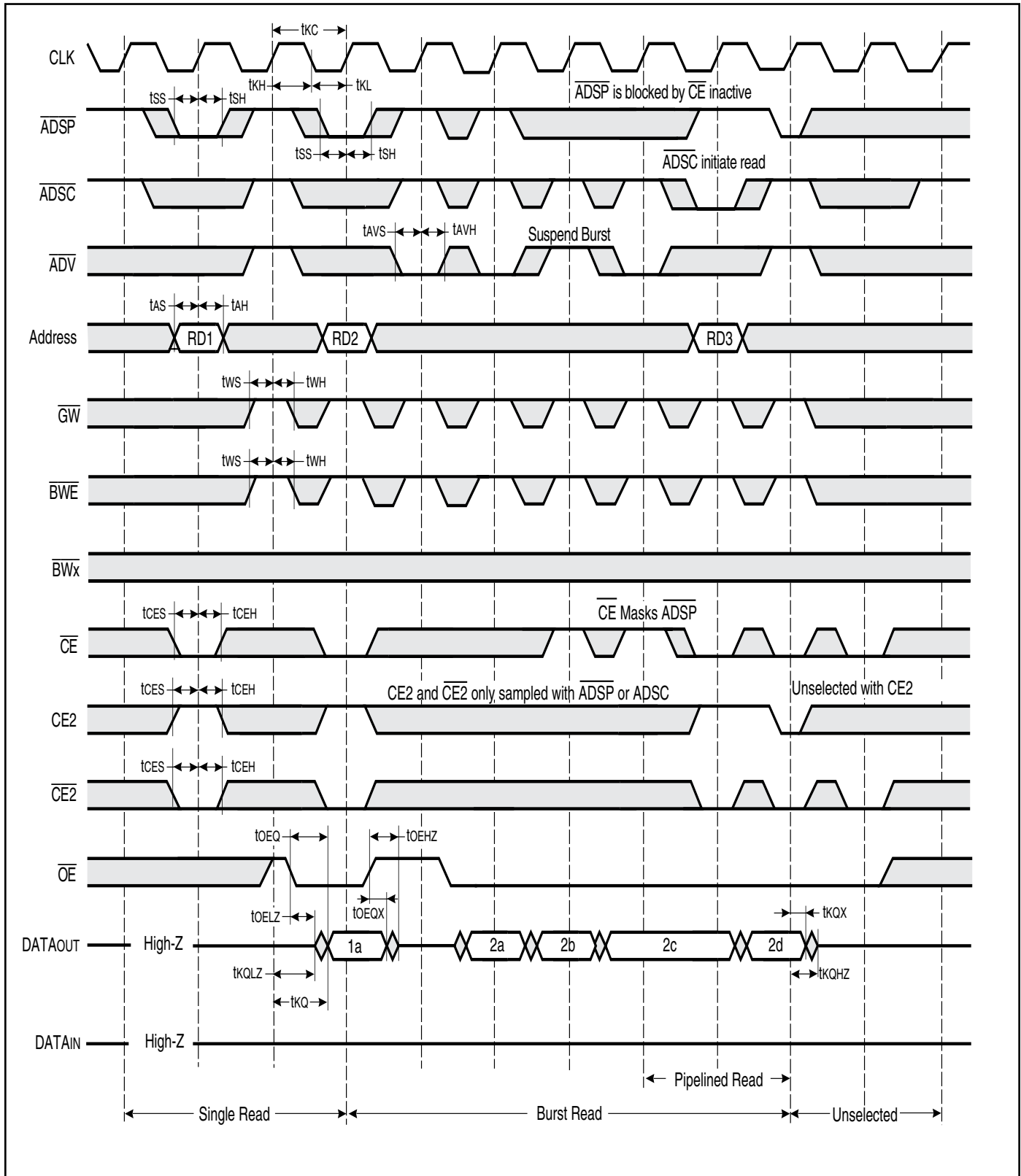

wRITE CYCLE TIMING

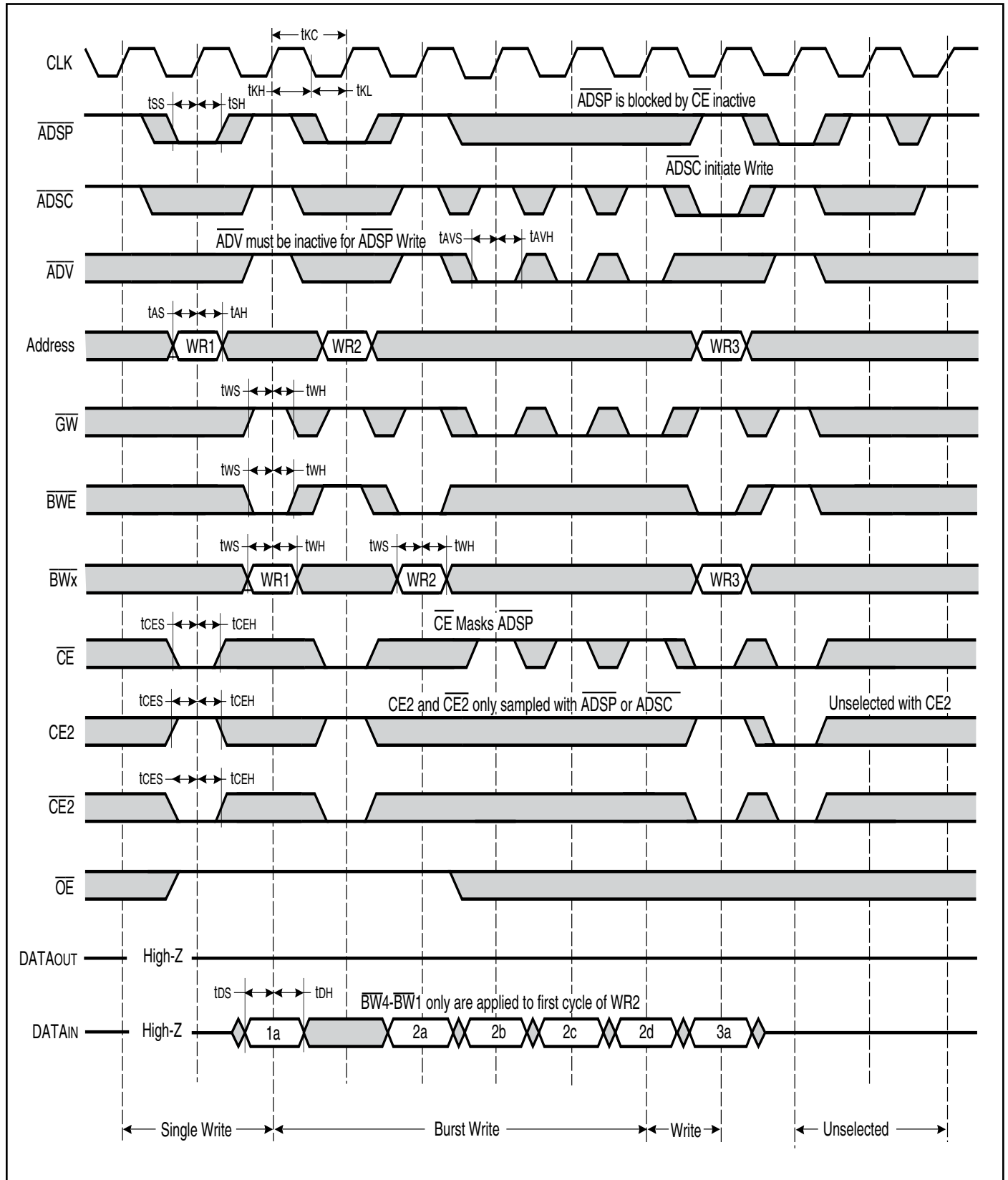

SNOOZE MODE ELECTRICAL CHARACTERISTICS

Symbol	Parameter	Conditions	Temperature Range	Min.	Max.	Unit
ISB2	Current during SNOOZE MODE	ZZ ≥ V _{DD} - 0.2V	Com.	—	120	mA
			Ind.	—	130	
			Auto.	—	250	
tpDS	ZZ active to input ignored			—	2	cycle
tpUS	ZZ inactive to input sampled			2	—	cycle
tzzI	ZZ active to SNOOZE current			—	2	cycle
trZZI	ZZ inactive to exit SNOOZE current			0	—	ns

SNOOZE MODE TIMING

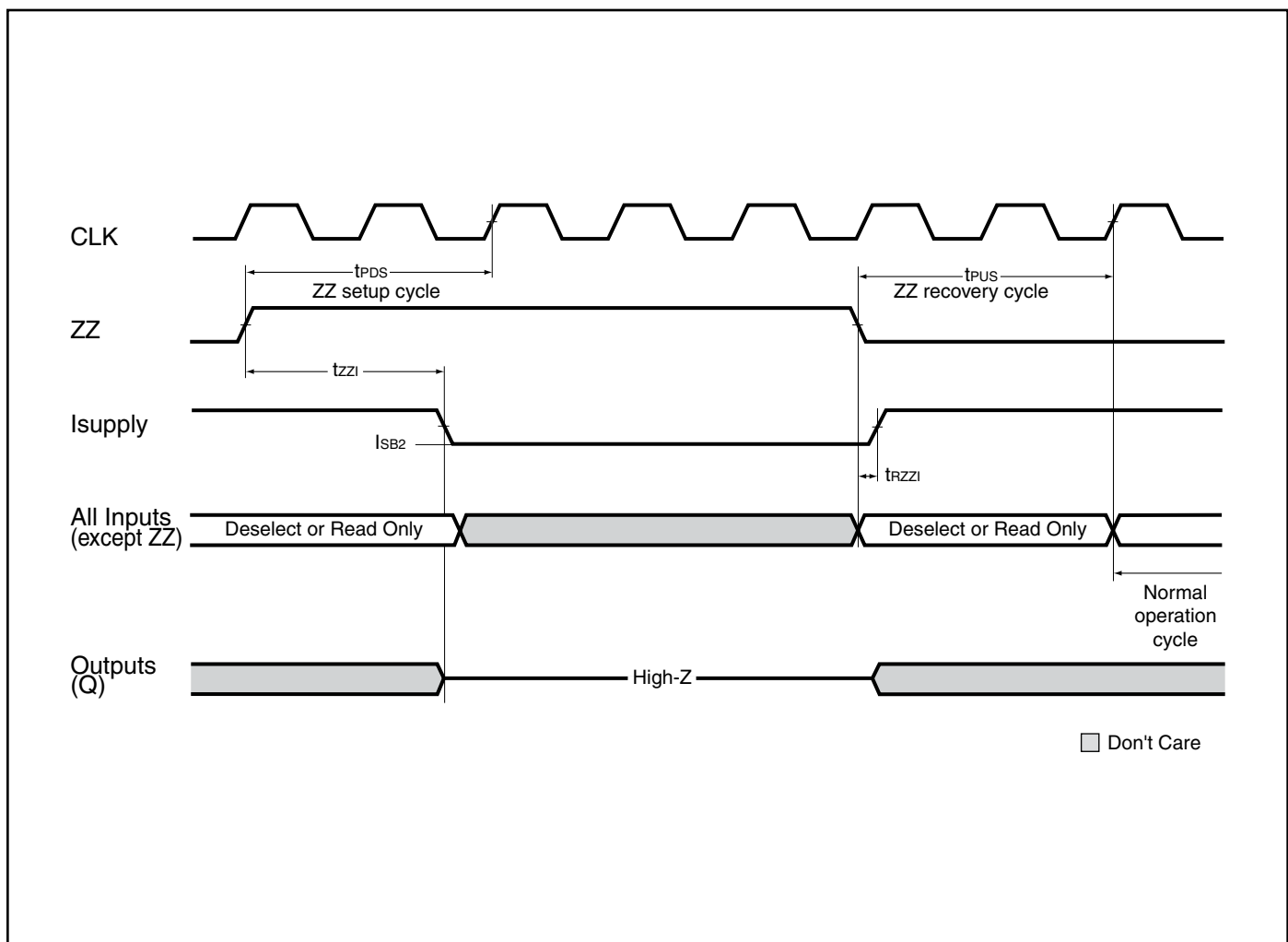

IEEE 1149.1 SERIAL BOUNDARY SCAN (JTAG)

The serial boundary scan Test Access Port (TAP) is only available in the PBGA package. (The TQFP package not available.) This port operates in accordance with IEEE Standard 1149.1-1900, but does not include all functions required for full 1149.1 compliance. These functions from the IEEE specification are excluded because they place added delay in the critical speed path of the SRAM. The TAP controller operates in a manner that does not conflict with the performance of other devices using 1149.1 fully compliant TAPs.

DISABLING THE JTAG FEATURE

The SRAM can operate without using the JTAG feature. To disable the TAP controller, TCK must be tied LOW (V_{SS}) to prevent clocking of the device. TDI and TMS are internally pulled up and may be disconnected. They may alternately be connected to V_{DD} through a pull-up resistor. TDO should be left disconnected. On power-up, the device will start in a reset state which will not interfere with the device operation.

TEST ACCESS PORT (TAP) - TEST CLOCK

The test clock is only used with the TAP controller. All inputs are captured on the rising edge of TCK and outputs are driven from the falling edge of TCK.

TEST MODE SELECT (TMS)

The TMS input is used to send commands to the TAP controller and is sampled on the rising edge of TCK. This pin may be left disconnected if the TAP is not used. The pin is internally pulled up, resulting in a logic HIGH level.

TEST DATA-IN (TDI)

The TDI pin is used to serially input information to the registers and can be connected to the input of any register. The register between TDI and TDO is chosen by the instruction loaded into the TAP instruction register. For information on instruction register loading, see the TAP Controller State Diagram. TDI is internally pulled up and can be disconnected if the TAP is unused in an application. TDI is connected to the Most Significant Bit (MSB) on any register.

TAP CONTROLLER BLOCK DIAGRAM

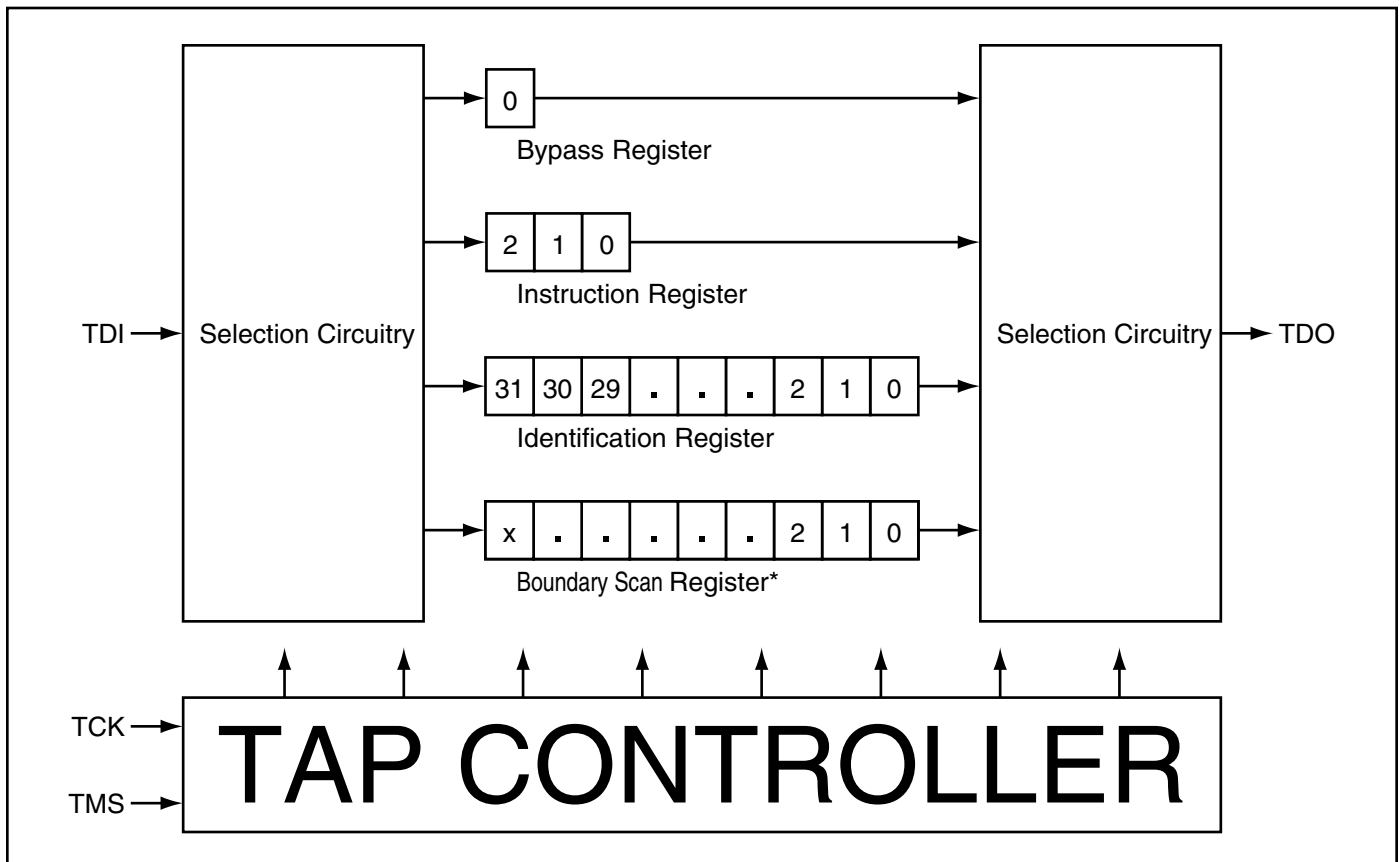



TEST DATA OUT (TDO)

The TDO output pin is used to serially clock data-out from the registers. The output is active depending on the current state of the TAP state machine (see TAP Controller State Diagram). The output changes on the falling edge of TCK and TDO is connected to the Least Significant Bit (LSB) of any register.

PERFORMING A TAP RESET

A Reset is performed by forcing TMS HIGH (V_{DD}) for five rising edges of TCK. RESET may be performed while the SRAM is operating and does not affect its operation. At power-up, the TAP is internally reset to ensure that TDO comes up in a high-Z state.

TAP REGISTERS

Registers are connected between the TDI and TDO pins and allow data to be scanned into and out of the SRAM test circuitry. Only one register can be selected at a time through the instruction registers. Data is serially loaded into the TDI pin on the rising edge of TCK and output on the TDO pin on the falling edge of TCK.

Instruction Register

Three-bit instructions can be serially loaded into the instruction register. This register is loaded when it is placed between the TDI and TDO pins. (See TAP Controller Block Diagram) At power-up, the instruction register is loaded with the IDCODE instruction. It is also loaded with the IDCODE instruction if the controller is placed in a reset state as previously described.

When the TAP controller is in the Capture-IR state, the two least significant bits are loaded with a binary "01" pattern to allow for fault isolation of the board level serial test path.

Bypass Register

To save time when serially shifting data through registers, it is sometimes advantageous to skip certain states. The bypass register is a single-bit register that can be placed between TDI and TDO pins. This allows data to be shifted through the SRAM with minimal delay. The bypass register is set LOW (V_{SS}) when the BYPASS instruction is executed.

IDENTIFICATION REGISTER DEFINITIONS

Instruction Field	Description	2M x 36	4M x 18
Revision Number (31:28)	Reserved for version number.	xxxx	xxxx
Device Depth (27:23)	Defines depth of SRAM. 2M or 4M	01010	01011
Device Width (22:18)	Defines width of the SRAM. x36 or x18	00100	00011
ISSI Device ID (17:12)	Reserved for future use.	xxxxx	xxxxx
ISSI JEDEC ID (11:1)	Allows unique identification of SRAM vendor.	00001010101	00001010101
ID Register Presence (0)	Indicate the presence of an ID register.	1	1

Boundary Scan Register

The boundary scan register is connected to all input and output pins on the SRAM. Several no connect (NC) pins are also included in the scan register to reserve pins for higher density devices. The x36 configuration has a 75-bit-long register and the x18 configuration also has a 75-bit-long register. The boundary scan register is loaded with the contents of the RAM Input and Output ring when the TAP controller is in the Capture-DR state and then placed between the TDI and TDO pins when the controller is moved to the Shift-DR state. The EXTEST, SAMPLE/PRELOAD and SAMPLE-Z instructions can be used to capture the contents of the Input and Output ring.

The Boundary Scan Order tables show the order in which the bits are connected. Each bit corresponds to one of the bumps on the SRAM package. The MSB of the register is connected to TDI, and the LSB is connected to TDO.

Scan Register Sizes

Register Name	Bit Size (x18)	Bit Size (x36)
Instruction	3	3
Bypass	1	1
ID	32	32
Boundary Scan	90	90

Identification (ID) Register

The ID register is loaded with a vendor-specific, 32-bit code during the Capture-DR state when the IDCODE command is loaded to the instruction register. The IDCODE is hardwired into the SRAM and can be shifted out when the TAP controller is in the Shift-DR state. The ID register has vendor code and other information described in the Identification Register Definitions table.

TAP INSTRUCTION SET

Eight instructions are possible with the three-bit instruction register and all combinations are listed in the Instruction Code table. Three instructions are listed as RESERVED and should not be used and the other five instructions are described below. The TAP controller used in this SRAM is not fully compliant with the 1149.1 convention because some mandatory instructions are not fully implemented. The TAP controller cannot be used to load address, data or control signals and cannot preload the Input or Output buffers. The SRAM does not implement the 1149.1 commands EXTEST or INTEST or the PRELOAD portion of SAMPLE/PRELOAD; instead it performs a capture of the Inputs and Output ring when these instructions are executed. Instructions are loaded into the TAP controller during the Shift-IR state when the instruction register is placed between TDI and TDO. During this state, instructions are shifted from the instruction register through the TDI and TDO pins. To execute an instruction once it is shifted in, the TAP controller must be moved into the Update-IR state.

EXTEST

EXTEST is a mandatory 1149.1 instruction which is to be executed whenever the instruction register is loaded with all 0s. Because EXTEST is not implemented in the TAP controller, this device is not 1149.1 standard compliant. The TAP controller recognizes an all-0 instruction. When an EXTEST instruction is loaded into the instruction register, the SRAM responds as if a SAMPLE/PRELOAD instruction has been loaded. There is a difference between the instructions, unlike the SAMPLE/PRELOAD instruction, EXTEST places the SRAM outputs in a High-Z state.

IDCODE

The IDCODE instruction causes a vendor-specific, 32-bit code to be loaded into the instruction register. It also places the instruction register between the TDI and TDO pins and allows the IDCODE to be shifted out of the device when the TAP controller enters the Shift-DR state. The IDCODE instruction is loaded into the instruction register upon power-up or whenever the TAP controller is given a test logic reset state.

SAMPLE-Z

The SAMPLE-Z instruction causes the boundary scan register to be connected between the TDI and TDO pins when the TAP controller is in a Shift-DR state. It also places all SRAM outputs into a High-Z state.

SAMPLE/PRELOAD

SAMPLE/PRELOAD is a 1149.1 mandatory instruction. The PRELOAD portion of this instruction is not implemented, so the TAP controller is not fully 1149.1 compliant. When the SAMPLE/PRELOAD instruction is loaded to the instruction register and the TAP controller is in the Capture-DR state, a snapshot of data on the inputs and output pins is captured in the boundary scan register.

It is important to realize that the TAP controller clock operates at a frequency up to 10 MHz, while the SRAM clock runs more than an order of magnitude faster. Because of the clock frequency differences, it is possible that during the Capture-DR state, an input or output will under-go a transition. The TAP may attempt a signal capture while in transition (metastable state). The device will not be harmed, but there is no guarantee of the value that will be captured or repeatable results.

To guarantee that the boundary scan register will capture the correct signal value, the SRAM signal must be stabilized long enough to meet the TAP controller's capture set-up plus hold times (t_{cs} and t_{ch}). To insure that the SRAM clock input is captured correctly, designs need a way to stop (or slow) the clock during a SAMPLE/PRELOAD instruction. If this is not an issue, it is possible to capture all other signals and simply ignore the value of the CLK captured in the boundary scan register.

Once the data is captured, it is possible to shift out the data by putting the TAP into the Shift-DR state. This places the boundary scan register between the TDI and TDO pins.

Note that since the PRELOAD part of the command is not implemented, putting the TAP into the Update to the Update-DR state while performing a SAMPLE/PRELOAD instruction will have the same effect as the Pause-DR command.

BYPASS

When the BYPASS instruction is loaded in the instruction register and the TAP is placed in a Shift-DR state, the bypass register is placed between the TDI and TDO pins. The advantage of the BYPASS instruction is that it shortens the boundary scan path when multiple devices are connected together on a board.

RESERVED

These instructions are not implemented but are reserved for future use. Do not use these instructions.

TAP Electrical Characteristics (V_{DDQ} = 3.3V Operating Range)

Symbol	Parameter	Test Conditions	Min.	Max.	Units
V _{OH1}	Output HIGH Voltage	I _{OH} = -4 mA	2.4	—	V
V _{OH2}	Output HIGH Voltage	I _{OH} = -100 μA	2.9	—	V
V _{OL1}	Output LOW Voltage	I _{OL} = 8 mA	—	0.4	V
V _{OL2}	Output LOW Voltage	I _{OL} = 100 μA	—	0.2	V
V _{IH}	Input HIGH Voltage		2.0	V _{DD} +0.3	V
V _{IL}	Input LOW Voltage		-0.3	0.8	V
I _X	Input Load Current	V _{SS} ≤ V _{IN} ≤ V _{DDQ}	-30	30	μA

TAP Electrical Characteristics (V_{DDQ} = 2.5V Operating Range)

Symbol	Parameter	Test Conditions	Min.	Max.	Units
V _{OH1}	Output HIGH Voltage	I _{OH} = -1 mA	2.0	—	V
V _{OH2}	Output HIGH Voltage	I _{OH} = -100 μA	2.1	—	V
V _{OL1}	Output LOW Voltage	I _{OL} = 1 mA	—	0.4	V
V _{OL2}	Output LOW Voltage	I _{OL} = 100 μA	—	0.2	V
V _{IH}	Input HIGH Voltage		1.7	V _{DD} +0.3	V
V _{IL}	Input LOW Voltage		-0.3	0.7	V
I _X	Input Load Current	V _{SS} ≤ V _{IN} ≤ V _{DDQ}	-30	30	μA

TAP Electrical Characteristics (V_{DDQ} = 1.8V Operating Range)

Symbol	Parameter	Test Conditions	Min.	Max.	Units
V _{OH1}	Output HIGH Voltage	I _{OH} = -1 mA	V _{DD} -0.4	—	V
V _{OL1}	Output LOW Voltage	I _{OL} = 1 mA	—	0.5	V
V _{IH}	Input HIGH Voltage		1.3	V _{DD} +0.3	V
V _{IL}	Input LOW Voltage		-0.3	0.7	V
I _X	Input Load Current	V _{SS} ≤ V _I ≤ V _{DDQ}	-30	30	μA

TAP AC ELECTRICAL CHARACTERISTICS (OVER OPERATING RANGE)

Parameter	Symbol	Min	Max	Units
TCK cycle time	t_{THTH}	100	—	ns
TCK high pulse width	t_{HTL}	40	—	ns
TCK low pulse width	t_{TLH}	40	—	ns
TMS Setup	t_{MVTH}	10	—	ns
TMS Hold	t_{THMX}	10	—	ns
TDI Setup	t_{DVTH}	10	—	ns
TDI Hold	t_{THDX}	10	—	ns
TCK Low to Valid Data	t_{TLOV}	—	20	ns

TAP AC TEST CONDITIONS (1.8V/2.5V/3.3V)

Input pulse levels	0 to 1.8V/0 to 2.5V/0 to 3.0V
Input rise and fall times	1.5ns
Input timing reference levels	0.9V/1.25V/1.5V
Output reference levels	0.9V/1.25V/1.5V
Test load termination supply voltage	0.9V/1.25V/1.5V
Vtrig	0.9V/1.25V/1.5V

TAP Output Load Equivalent

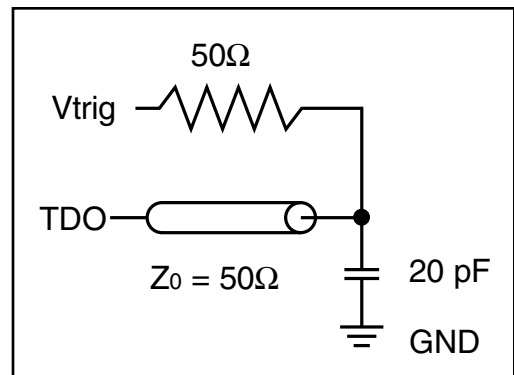

TAP TIMING

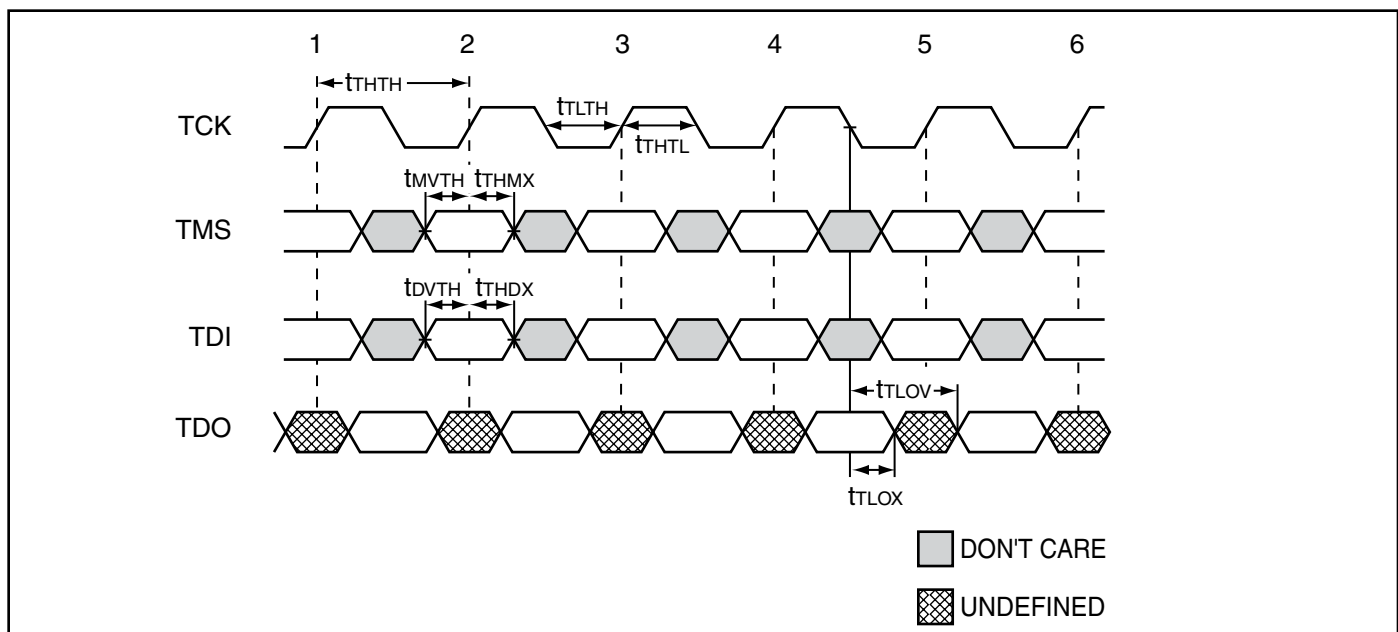

BOUNDARY SCAN ORDER

165 BgA					119 BgA				
X36			X18		X36			X18	
Bit #	Bump ID	Signal	Bump ID	Signal	Bit #	Bump ID	Signal	Bump ID	Signal
1	N6	A9	N6	A9	1	C7	NC	C7	NC
2	N7	NC	N7	NC	2	R5	NC	R5	NC
3	N10	NC	N10	NC	3	R7	NC	R7	NC
4	P11	A8	P11	A8	4	U6	NC	U6	NC
5	P8	A18	P8	A18	5	B5	A18	B5	A18
6	R8	A17	R8	A17	6	C6	A17	C6	A17
7	R9	A16	R9	A16	7	T3	A16	T3	A16
8	P9	A15	P9	A15	8	T4	A15	T4	A15
9	P10	A14	P10	A14	9	T5	A14	T5	A14
10	R10	A13	R10	A13	10	T6	A13	T6	A13
11	R11	A12	R11	A12	11	R6	A12	R6	A12
12	H11	ZZ	H11	ZZ	12	T7	ZZ	T7	ZZ
13	N11	DQa0	N11	NC	13	P6	DQa0	P6	NC
14	M11	DQa1	M11	NC	14	N7	DQa1	N7	NC
15	L11	DQa2	L11	NC	15	M6	DQa2	M6	NC
16	K11	DQa6	K11	NC	16	L7	DQa6	L7	NC
17	J11	DQa7	J11	NC	17	K6	DQa7	K6	NC
18	M10	DQa3	M10	DQa8	18	P7	DQa3	P7	DQa8
19	L10	DQa4	L10	DQa7	19	N6	DQa4	N6	DQa7
20	K10	DQa5	K10	DQa6	20	L6	DQa5	L6	DQa6
21	J10	DQa8	J10	DQa5	21	K7	DQa8	K7	DQa5
22	H9	NC	H9	NC	22	-	NC	-	NC
23	H10	NC	H10	NC	23	-	NC	-	NC
24	G11	DQb8	G11	DQa4	24	H6	DQb8	H6	DQa4
25	F11	DQb7	F11	DQa3	25	G7	DQb7	G7	DQa3
26	E11	DQb5	E11	DQa2	26	F6	DQb5	F6	DQa2
27	D11	DQb4	D11	DQa1	27	E7	DQb4	E7	DQa1
28	G10	DQb6	G10	NC	28	H7	DQb6	H7	NC
29	F10	DQb3	F10	NC	29	G6	DQb3	G6	NC
30	E10	DQb2	E10	NC	30	E6	DQb2	E6	NC
31	D10	DQb1	D10	NC	31	D7	DQb1	D7	NC
32	C11	DQb0	C11	DQa0	32	D6	DQb0	D6	DQa0
33	A11	NC	A11	A21	33	T1	NC	T1	A21
34	B11	NC	B11	NC	34	R1	NC	R1	NC
35	A10	A11	A10	A11	35	A6	A11	A6	A11
36	B10	A10	B10	A10	36	A5	A10	A5	A10
37	A9	/ADV	A9	/ADV	37	G4	/ADV	G4	/ADV
38	B9	/ADSP	B9	/ADSP	38	A4	/ADSP	A4	/ADSP
39	C10	NC	C10	NC	39	B7	NC	B7	NC
40	A8	/ADSC	A8	/ADSC	40	B4	/ADSC	B4	/ADSC
41	B8	/OE	B8	/OE	41	F4	/OE	F4	/OE
42	A7	/BWE	A7	/BWE	42	M4	/BWE	M4	/BWE
43	B7	/GW	B7	/GW	43	H4	/GW	H4	/GW
44	B6	CLK	B6	CLK	44	K4	CLK	K4	CLK



165 BgA					119 BgA				
Bit #	X36		X18		Bit #	X36		X18	
	Bump ID	Signal	Bump ID	Signal		Bump ID	Signal	Bump ID	Signal
45	A6	/CE2	A6	/CE2	45	B6	A9	B6	A9
46	B5	/Bwa	B5	/Bwa	46	L5	/Bwa	L5	/Bwa
47	A5	/Bwb	A5	NC	47	G5	/Bwb	G5	NC
48	A4	/Bwc	A4	/Bwb	48	G3	/Bwc	G3	/Bwb
49	B4	/Bwd	B4	NC	49	L3	/Bwd	L3	NC
50	B3	CE2	B3	CE2	50	B2	A8	B2	A8
51	A3	/CE1	A3	/CE1	51	E4	/CE1	E4	/CE1
52	A2	A7	A2	A7	52	A3	A7	A3	A7
53	B2	A6	B2	A6	53	A2	A6	A2	A6
54	C2	NC	C2	NC	54	B1	NC	B1	NC
55	B1	NC	B1	NC	55	C1	NC	C1	NC
56	A1	NC	A1	NC	56	D4	NC	D4	NC
57	C1	DQc0	C1	NC	57	D2	DQc0	D2	NC
58	D1	DQc1	D1	NC	58	E1	DQc1	E1	NC
59	E1	DQc2	E1	NC	59	F2	DQc2	F2	NC
60	F1	DQc6	F1	NC	60	G1	DQc6	G1	NC
61	G1	DQc7	G1	NC	61	H2	DQc7	H2	NC
62	D2	DQc3	D2	DQb8	62	D1	DQc3	D1	DQb8
63	E2	DQc4	E2	DQb7	63	E2	DQc4	E2	DQb7
64	F2	DQc5	F2	DQb6	64	G2	DQc5	G2	DQb6
65	G2	DQc8	G2	DQb5	65	H1	DQc8	H1	DQb5
66	H1	NC	H1	NC	66	-	NC	-	NC
67	H2	NC	H2	NC	67	-	NC	-	NC
68	H3	NC	H3	NC	68	-	NC	-	NC
69	J1	DQd8	J1	DQb4	69	K2	DQd8	K2	DQb4
70	K1	DQd7	K1	DQb3	70	L1	DQd7	L1	DQb3
71	L1	DQd5	L1	DQb2	71	M2	DQd5	M2	DQb2
72	M1	DQd4	M1	DQb1	72	N1	DQd4	N1	DQb1
73	J2	DQd6	J2	NC	73	K1	DQd6	K1	NC
74	K2	DQd3	K2	NC	74	L2	DQd3	L2	NC
75	L2	DQd2	L2	NC	75	N2	DQd2	N2	NC
76	M2	DQd1	M2	NC	76	P1	DQd1	P1	NC
77	N1	DQd0	N1	DQb0	77	P2	DQd0	P2	DQb0
78	N2	NC	N2	NC	78	L4	NC	L4	NC
79	P1	NC	P1	NC	79	J5	NC	J5	NC
80	R1	MODE	R1	MODE	80	R3	MODE	R3	MODE
81	R2	A4	R2	A4	81	C2	A4	C2	A4
82	P3	A3	P3	A3	82	B3	A3	B3	A3
83	R3	A2	R3	A2	83	C3	A2	C3	A2
84	P2	A5	P2	A5	84	R2	A5	R2	A5
85	R4	A19	R4	A19	85	C5	A19	C5	A19
86	P4	A20	P4	A20	86	T2	A20	T2	A20
87	N5	NC	N5	NC	87	J3	NC	J3	NC
88	P6	A1	P6	A1	88	N4	A1	N4	A1
89	R6	A0	R6	A0	89	P4	A0	P4	A0
90	*	Int	*	Int	90	*	Int	*	Int



IS61LPS409618B, IS61LPS204836B, IS61LPS204832B, IS64LPS204836B,
IS61VPS/VVPS409618B, IS61VPS/VVPS204836B

ORDERING INFORMATION

Commercial Range: 0°C to 70°C (vDD = 3.3v / vDDQ = 2.5v/3.3v)

Speed	x32		Package
200MHz	IS61LPS204832B-200TQ		100 TQFP, 3CE
	IS61LPS204832B-200TQL		100 TQFP, 3CE, Lead-free
	IS61LPS204832B-200TQ2		100 TQFP, 2CE
	IS61LPS204832B-200TQ2L		100 TQFP, 2CE, Lead-free

Speed	x36	x18	Package
250MHz	IS61LPS204836B-250TQ	IS61LPS409618B-250TQ	100 TQFP, 3CE
	IS61LPS204836B-250TQ2	IS61LPS409618B-250TQ2	100 TQFP, 2CE
	IS61LPS204836B-250B3	IS61LPS409618B-250B3	165 PBGA, 13x15mm
	IS61LPS204836B-250M3	IS61LPS409618B-250M3	165 PBGA, 15x17mm
	IS61LPS204836B-250B2	IS61LPS409618B-250B2	119 PBGA
	IS61LPS204836B-250TQL	IS61LPS409618B-250TQL	100 TQFP, 3CE, Lead-free
	IS61LPS204836B-250TQ2L	IS61LPS409618B-250TQ2L	100 TQFP, 2CE, Lead-free
	IS61LPS204836B-250B3L	IS61LPS409618B-250B3L	165 PBGA, 13x15mm, Lead-free
	IS61LPS204836B-250M3L	IS61LPS409618B-250M3L	165 PBGA, 15x17mm, Lead-free
	IS61LPS204836B-250B2L	IS61LPS409618B-250B2L	119 PBGA, Lead-free
200MHz	IS61LPS204836B-200TQ	IS61LPS409618B-200TQ	100 TQFP, 3CE
	IS61LPS204836B-200TQ2	IS61LPS409618B-200TQ2	100 TQFP, 2CE
	IS61LPS204836B-200B3	IS61LPS409618B-200B3	165 PBGA, 13x15mm
	IS61LPS204836B-200M3	IS61LPS409618B-200M3	165 PBGA, 15x17mm
	IS61LPS204836B-200B2	IS61LPS409618B-200B2	119 PBGA
	IS61LPS204836B-200TQL	IS61LPS409618B-200TQL	100 TQFP, 3CE, Lead-free
	IS61LPS204836B-200TQ2L	IS61LPS409618B-200TQ2L	100 TQFP, 2CE, Lead-free
	IS61LPS204836B-200B3L	IS61LPS409618B-200B3L	165 PBGA, 13x15mm, Lead-free
	IS61LPS204836B-200M3L	IS61LPS409618B-200M3L	165 PBGA, 15x17mm, Lead-free
	IS61LPS204836B-200B2L	IS61LPS409618B-200B2L	119 PBGA, Lead-free
166MHz	IS61LPS204836B-166TQ	IS61LPS409618B-166TQ	100 TQFP, 2CE
	IS61LPS204836B-166TQ2	IS61LPS409618B-166TQ2	100 TQFP, 3CE
	IS61LPS204836B-166B3	IS61LPS409618B-166B3	165 PBGA, 13x15mm
	IS61LPS204836B-166M3	IS61LPS409618B-166M3	165 PBGA, 15x17mm
	IS61LPS204836B-166B2	IS61LPS409618B-166B2	119 PBGA
	IS61LPS204836B-166TQL	IS61LPS409618B-166TQL	100 TQFP, 3CE, Lead-free
	IS61LPS204836B-166TQ2L	IS61LPS409618B-166TQ2L	100 TQFP, 2CE, Lead-free
	IS61LPS204836B-166B3L	IS61LPS409618B-166B3L	165 PBGA, 13x15mm, Lead-free
	IS61LPS204836B-166M3L	IS61LPS409618B-166M3L	165 PBGA, 15x17mm, Lead-free
	IS61LPS204836B-166B2L	IS61LPS409618B-166B2L	119 PBGA, Lead-free



Commercial Range: 0°C to 70°C (vDD = 2.5v / vDDQ = 2.5v)

Speed	x36	x18	Package
250MHz	IS61VPS204836B-250TQ	IS61VPS409618B-250TQ	100 TQFP, 3CE
	IS61VPS204836B-250TQ2	IS61VPS409618B-250TQ2	100 TQFP, 2CE
	IS61VPS204836B-250B3	IS61VPS409618B-250B3	165 PBGA, 13x15mm
	IS61VPS204836B-250M3	IS61VPS409618B-250M3	165 PBGA, 15x17mm
	IS61VPS204836B-250B2	IS61VPS409618B-250B2	119 PBGA
	IS61VPS204836B-250TQL	IS61VPS409618B-250TQL	100 TQFP, 3CE, Lead-free
	IS61VPS204836B-250TQ2L	IS61VPS409618B-250TQ2L	100 TQFP, 2CE, Lead-free
	IS61VPS204836B-250B3L	IS61VPS409618B-250B3L	165 PBGA, 13x15mm, Lead-free
	IS61VPS204836B-250M3L	IS61VPS409618B-250M3L	165 PBGA, 15x17mm, Lead-free
	IS61VPS204836B-250B2L	IS61VPS409618B-250B2L	119 PBGA, Lead-free
200MHz	IS61VPS204836B-200TQ	IS61VPS409618B-200TQ	100 TQFP, 3CE
	IS61VPS204836B-200TQ2	IS61VPS409618B-200TQ2	100 TQFP, 2CE
	IS61VPS204836B-200B3	IS61VPS409618B-200B3	165 PBGA, 13x15mm
	IS61VPS204836B-200M3	IS61VPS409618B-200M3	165 PBGA, 15x17mm
	IS61VPS204836B-200B2	IS61VPS409618B-200B2	119 PBGA
	IS61VPS204836B-200TQL	IS61VPS409618B-200TQL	100 TQFP, 3CE, Lead-free
	IS61VPS204836B-200TQ2L	IS61VPS409618B-200TQ2L	100 TQFP, 2CE, Lead-free
	IS61VPS204836B-200B3L	IS61VPS409618B-200B3L	165 PBGA, 13x15mm, Lead-free
	IS61VPS204836B-200M3L	IS61VPS409618B-200M3L	165 PBGA, 15x17mm, Lead-free
	IS61VPS204836B-200B2L	IS61VPS409618B-200B2L	119 PBGA, Lead-free
166MHz	IS61VPS204836B-166TQ	IS61VPS409618B-166TQ	100 TQFP, 3CE
	IS61VPS204836B-166TQ2	IS61VPS409618B-166TQ2	100 TQFP, 2CE
	IS61VPS204836B-166B3	IS61VPS409618B-166B3	165 PBGA, 13x15mm
	IS61VPS204836B-166M3	IS61VPS409618B-166M3	165 PBGA, 15x17mm
	IS61VPS204836B-166B2	IS61VPS409618B-166B2	119 PBGA
	IS61VPS204836B-166TQL	IS61VPS409618B-166TQL	100 TQFP, 3CE, Lead-free
	IS61VPS204836B-166TQ2L	IS61VPS409618B-166TQ2L	100 TQFP, 2CE, Lead-free
	IS61VPS204836B-166B3L	IS61VPS409618B-166B3L	165 PBGA, 13x15mm, Lead-free
	IS61VPS204836B-166M3L	IS61VPS409618B-166M3L	165 PBGA, 15x17mm, Lead-free
	IS61VPS204836B-166B2L	IS61VPS409618B-166B2L	119 PBGA, Lead-free



Commercial Range: 0°C to 70°C (vDD = 1.8v / vDDQ = 1.8v)

Speed	x36	x18	Package
200MHz	Please contact ISSI SRAM@issi.com		
166MHz	IS61VVPS204836B-166TQ	IS61VVPS409618B-166TQ	100 TQFP, 3CE
	IS61VVPS204836B-166TQ2	IS61VVPS409618B-166TQ2	100 TQFP, 2CE
	IS61VVPS204836B-166B3	IS61VVPS409618B-166B3	165 PBGA, 13x15mm
	IS61VVPS204836B-166M3	IS61VVPS409618B-166M3	165 PBGA, 15x17mm
	IS61VVPS204836B-166B2	IS61VVPS409618B-166B2	119 PBGA
	IS61VVPS204836B-166TQL	IS61VVPS409618B-166TQL	100 TQFP, 3CE, Lead-free
	IS61VVPS204836B-166TQ2L	IS61VVPS409618B-166TQ2L	100 TQFP, 2CE, Lead-free
	IS61VVPS204836B-166B3L	IS61VVPS409618B-166B3L	165 PBGA, 13x15mm, Lead-free
	IS61VVPS204836B-166M3L	IS61VVPS409618B-166M3L	165 PBGA, 15x17mm, Lead-free
	IS61VVPS204836B-166B2L	IS61VVPS409618B-166B2L	119 PBGA, Lead-free

Industrial Range: -40°C to +85°C (vDD = 3.3v / vDDQ = 2.5v/3.3v)

Speed	x32	Package
200MHz	IS61LPS204832B-200TQI	100 TQFP, 3CE
	IS61LPS204832B-200TQLI	100 TQFP, 3CE, Lead-free
	IS61LPS204832B-200TQ2I	100 TQFP, 2CE
	IS61LPS204832B-200TQ2LI	100 TQFP, 2CE, Lead-free

Speed	x36	x18	Package
250MHz	IS61LPS204836B-250TQI	IS61LPS409618B-250TQI	100 TQFP, 3CE
	IS61LPS204836B-250TQ2I	IS61LPS409618B-250TQ2I	100 TQFP, 2CE
	IS61LPS204836B-250B3I	IS61LPS409618B-250B3I	165 PBGA, 13x15mm
	IS61LPS204836B-250M3I	IS61LPS409618B-250M3I	165 PBGA, 15x17mm
	IS61LPS204836B-250B2I	IS61LPS409618B-250B2I	119 PBGA
	IS61LPS204836B-250TQLI	IS61LPS409618B-250TQLI	100 TQFP, 3CE, Lead-free
	IS61LPS204836B-250TQ2LI	IS61LPS409618B-250TQ2LI	100 TQFP, 2CE, Lead-free
	IS61LPS204836B-250B3LI	IS61LPS409618B-250B3LI	165 PBGA, 13x15mm, Lead-free
	IS61LPS204836B-250M3LI	IS61LPS409618B-250M3LI	165 PBGA, 15x17mm, Lead-free
	IS61LPS204836B-250B2LI	IS61LPS409618B-250B2LI	119 PBGA, Lead-free



Speed	x36	x18	Package
200MHz	IS61LPS204836B-200TQI	IS61LPS409618B-200TQI	100 TQFP, 3CE
	IS61LPS204836B-200TQ2I	IS61LPS409618B-200TQ2I	100 TQFP, 2CE
	IS61LPS204836B-200B3I	IS61LPS409618B-200B3I	165 PBGA, 13x15mm
	IS61LPS204836B-200M3I	IS61LPS409618B-200M3I	165 PBGA, 15x17mm
	IS61LPS204836B-200B2I	IS61LPS409618B-200B2I	119 PBGA
	IS61LPS204836B-200TQLI	IS61LPS409618B-200TQLI	100 TQFP, 3CE, Lead-free
	IS61LPS204836B-200TQ2LI	IS61LPS409618B-200TQ2LI	100 TQFP, 2CE, Lead-free
	IS61LPS204836B-200B3LI	IS61LPS409618B-200B3LI	165 PBGA, 13x15mm, Lead-free
	IS61LPS204836B-200M3LI	IS61LPS409618B-200M3LI	165 PBGA, 15x17mm, Lead-free
	IS61LPS204836B-200B2LI	IS61LPS409618B-200B2LI	119 PBGA, Lead-free
166MHz	IS61LPS204836B-166TQI	IS61LPS409618B-166TQI	100 TQFP, 2CE
	IS61LPS204836B-166TQ2I	IS61LPS409618B-166TQ2I	100 TQFP, 3CE
	IS61LPS204836B-166B3I	IS61LPS409618B-166B3I	165 PBGA, 13x15mm
	IS61LPS204836B-166M3I	IS61LPS409618B-166M3I	165 PBGA, 15x17mm
	IS61LPS204836B-166B2I	IS61LPS409618B-166B2I	119 PBGA
	IS61LPS204836B-166TQLI	IS61LPS409618B-166TQLI	100 TQFP, 3CE, Lead-free
	IS61LPS204836B-166TQ2LI	IS61LPS409618B-166TQ2LI	100 TQFP, 2CE, Lead-free
	IS61LPS204836B-166B3LI	IS61LPS409618B-166B3LI	165 PBGA, 13x15mm, Lead-free
	IS61LPS204836B-166M3LI	IS61LPS409618B-166M3LI	165 PBGA, 15x17mm, Lead-free
	IS61LPS204836B-166B2LI	IS61LPS409618B-166B2LI	119 PBGA, Lead-free

Industrial Range: -40°C to +85°C (vDD = 2.5v / vDDQ = 2.5v)

Speed	x36	x18	Package
250MHz	IS61VPS204836B-250TQI	IS61VPS409618B-250TQI	100 TQFP, 3CE
	IS61VPS204836B-250TQ2I	IS61VPS409618B-250TQ2I	100 TQFP, 2CE
	IS61VPS204836B-250B3I	IS61VPS409618B-250B3I	165 PBGA, 13x15mm
	IS61VPS204836B-250M3I	IS61VPS409618B-250M3I	165 PBGA, 15x17mm
	IS61VPS204836B-250B2I	IS61VPS409618B-250B2I	119 PBGA
	IS61VPS204836B-250TQLI	IS61VPS409618B-250TQLI	100 TQFP, 3CE, Lead-free
	IS61VPS204836B-250TQ2LI	IS61VPS409618B-250TQ2LI	100 TQFP, 2CE, Lead-free
	IS61VPS204836B-250B3LI	IS61VPS409618B-250B3LI	165 PBGA, 13x15mm, Lead-free
	IS61VPS204836B-250M3LI	IS61VPS409618B-250M3LI	165 PBGA, 15x17mm, Lead-free
	IS61VPS204836B-250B2LI	IS61VPS409618B-250B2LI	119 PBGA, Lead-free
200MHz	IS61VPS204836B-200TQI	IS61VPS409618B-200TQI	100 TQFP, 3CE
	IS61VPS204836B-200TQ2I	IS61VPS409618B-200TQ2I	100 TQFP, 2CE
	IS61VPS204836B-200B3I	IS61VPS409618B-200B3I	165 PBGA, 13x15mm
	IS61VPS204836B-200M3I	IS61VPS409618B-200M3I	165 PBGA, 15x17mm
	IS61VPS204836B-200B2I	IS61VPS409618B-200B2I	119 PBGA
	IS61VPS204836B-200TQLI	IS61VPS409618B-200TQLI	100 TQFP, 3CE, Lead-free
	IS61VPS204836B-200TQ2LI	IS61VPS409618B-200TQ2LI	100 TQFP, 2CE, Lead-free
	IS61VPS204836B-200B3LI	IS61VPS409618B-200B3LI	165 PBGA, 13x15mm, Lead-free
	IS61VPS204836B-200M3LI	IS61VPS409618B-200M3LI	165 PBGA, 15x17mm, Lead-free
	IS61VPS204836B-200B2LI	IS61VPS409618B-200B2LI	119 PBGA, Lead-free



**IS61LPS409618B, IS61LPS204836B, IS61LPS204832B, IS64LPS204836B,
IS61VPS/VVPS409618B, IS61VPS/VVPS204836B**

Speed	x36	x18	Package
166MHz	IS61VPS204836B-166TQI	IS61VPS409618B-166TQI	100 TQFP, 3CE
	IS61VPS204836B-166TQ2I	IS61VPS409618B-166TQ2I	100 TQFP, 2CE
	IS61VPS204836B-166B3I	IS61VPS409618B-166B3I	165 PBGA, 13x15mm
	IS61VPS204836B-166M3I	IS61VPS409618B-166M3I	165 PBGA, 15x17mm
	IS61VPS204836B-166B2I	IS61VPS409618B-166B2I	119 PBGA
	IS61VPS204836B-166TQLI	IS61VPS409618B-166TQLI	100 TQFP, 3CE, Lead-free
	IS61VPS204836B-166TQ2LI	IS61VPS409618B-166TQ2LI	100 TQFP, 2CE, Lead-free
	IS61VPS204836B-166B3LI	IS61VPS409618B-166B3LI	165 PBGA, 13x15mm, Lead-free
	IS61VPS204836B-166M3LI	IS61VPS409618B-166M3LI	165 PBGA, 15x17mm, Lead-free
	IS61VPS204836B-166B2LI	IS61VPS409618B-166B2LI	119 PBGA, Lead-free

Industrial Range: -40°C to +85°C (vDD = 1.8v / vDDQ = 1.8v)

Speed	x36	x18	Package
200MHz	IS61VVPS204836B-200TQI	IS61VVPS409618B-200TQI	100 TQFP, 3CE
	IS61VVPS204836B-200TQ2I	IS61VVPS409618B-200TQ2I	100 TQFP, 2CE
	IS61VVPS204836B-200B3I	IS61VVPS409618B-200B3I	165 PBGA, 13x15mm
	IS61VVPS204836B-200M3I	IS61VVPS409618B-200M3I	165 PBGA, 15x17mm
	IS61VVPS204836B-200B2I	IS61VVPS409618B-200B2I	119 PBGA
	IS61VVPS204836B-200TQLI	IS61VVPS409618B-200TQLI	100 TQFP, 3CE, Lead-free
	IS61VVPS204836B-200TQ2LI	IS61VVPS409618B-200TQ2LI	100 TQFP, 2CE, Lead-free
	IS61VVPS204836B-200B3LI	IS61VVPS409618B-200B3LI	165 PBGA, 13x15mm, Lead-free
	IS61VVPS204836B-200M3LI	IS61VVPS409618B-200M3LI	165 PBGA, 15x17mm, Lead-free
	IS61VVPS204836B-200B2LI	IS61VVPS409618B-200B2LI	119 PBGA, Lead-free
166MHz	IS61VVPS204836B-166TQI	IS61VVPS409618B-166TQI	100 TQFP, 3CE
	IS61VVPS204836B-166TQ2I	IS61VVPS409618B-166TQ2I	100 TQFP, 2CE
	IS61VVPS204836B-166B3I	IS61VVPS409618B-166B3I	165 PBGA, 13x15mm
	IS61VVPS204836B-166M3I	IS61VVPS409618B-166M3I	165 PBGA, 15x17mm
	IS61VVPS204836B-166B2I	IS61VVPS409618B-166B2I	119 PBGA
	IS61VVPS204836B-166TQLI	IS61VVPS409618B-166TQLI	100 TQFP, 3CE, Lead-free
	IS61VVPS204836B-166TQ2LI	IS61VVPS409618B-166TQ2LI	100 TQFP, 2CE, Lead-free
	IS61VVPS204836B-166B3LI	IS61VVPS409618B-166B3LI	165 PBGA, 13x15mm, Lead-free
	IS61VVPS204836B-166M3LI	IS61VVPS409618B-166M3LI	165 PBGA, 15x17mm, Lead-free
	IS61VVPS204836B-166B2LI	IS61VVPS409618B-166B2LI	119 PBGA, Lead-free



Automotive(A3) Range: -40°C to +125°C (vDD = 3.3v / vDDQ = 2.5v/3.3v)

Speed	X32	Package
Please contact ISSI SRAM@issi.com		

Speed	x36	x18	Package
200MHz	Please contact ISSI SRAM@issi.com		
166MHz	IS64LPS204836B-166TQA3	IS64LPS409618B-166TQA3	100 TQFP, 2CE
	IS64LPS204836B-166TQ2A3	IS64LPS409618B-166TQ2A3	100 TQFP, 3CE
	IS64LPS204836B-166B3A3	IS64LPS409618B-166B3A3	165 PBGA, 13x15mm
	IS64LPS204836B-166M3A3	IS64LPS409618B-166M3A3	165 PBGA, 15x17mm
	IS64LPS204836B-166B2A3	IS64LPS409618B-166B2A3	119 PBGA
	IS64LPS204836B-166TQLA3	IS64LPS409618B-166TQLA3	100 TQFP, 3CE, Lead-free
	IS64LPS204836B-166TQ2LA3	IS64LPS409618B-166TQ2LA3	100 TQFP, 2CE, Lead-free
	IS64LPS204836B-166B3LA3	IS64LPS409618B-166B3LA3	165 PBGA, 13x15mm, Lead-free
	IS64LPS204836B-166M3LA3	IS64LPS409618B-166M3LA3	165 PBGA, 15x17mm, Lead-free
	IS64LPS204836B-166B2LA3	IS64LPS409618B-166B2LA3	119 PBGA, Lead-free

Automotive(A3) Range: -40°C to +125°C (vDD = 2.5v / vDDQ = 2.5v)

Speed	x36	x18	Package
200MHz	IS64VPS204836B-200TQA3	IS64VPS409618B-200TQA3	100 TQFP, 3CE
	IS64VPS204836B-200TQ2A3	IS64VPS409618B-200TQ2A3	100 TQFP, 2CE
	IS64VPS204836B-200B3A3	IS64VPS409618B-200B3A3	165 PBGA, 13x15mm
	IS64VPS204836B-200M3A3	IS64VPS409618B-200M3A3	165 PBGA, 15x17mm
	IS64VPS204836B-200B2A3	IS64VPS409618B-200B2A3	119 PBGA
	IS64VPS204836B-200TQLA3	IS64VPS409618B-200TQLA3	100 TQFP, 3CE, Lead-free
	IS64VPS204836B-200TQ2LA3	IS64VPS409618B-200TQ2LA3	100 TQFP, 2CE, Lead-free
	IS64VPS204836B-200B3LA3	IS64VPS409618B-200B3LA3	165 PBGA, 13x15mm, Lead-free
	IS64VPS204836B-200M3LA3	IS64VPS409618B-200M3LA3	165 PBGA, 15x17mm, Lead-free
	IS64VPS204836B-200B2LA3	IS64VPS409618B-200B2LA3	119 PBGA, Lead-free
166MHz	IS64VPS204836B-166TQA3	IS64VPS409618B-166TQA3	100 TQFP, 3CE
	IS64VPS204836B-166TQ2A3	IS64VPS409618B-166TQ2A3	100 TQFP, 2CE
	IS64VPS204836B-166B3A3	IS64VPS409618B-166B3A3	165 PBGA, 13x15mm
	IS64VPS204836B-166M3A3	IS64VPS409618B-166M3A3	165 PBGA, 15x17mm
	IS64VPS204836B-166B2A3	IS64VPS409618B-166B2A3	119 PBGA
	IS64VPS204836B-166TQLA3	IS64VPS409618B-166TQLA3	100 TQFP, 3CE, Lead-free
	IS64VPS204836B-166TQ2LA3	IS64VPS409618B-166TQ2LA3	100 TQFP, 2CE, Lead-free
	IS64VPS204836B-166B3LA3	IS64VPS409618B-166B3LA3	165 PBGA, 13x15mm, Lead-free
	IS64VPS204836B-166M3LA3	IS64VPS409618B-166M3LA3	165 PBGA, 15x17mm, Lead-free
	IS64VPS204836B-166B2LA3	IS64VPS409618B-166B2LA3	119 PBGA, Lead-free



IS61LPS409618B, IS61LPS204836B, IS61LPS204832B, IS64LPS204836B,
IS61VPS/VVPS409618B, IS61VPS/VVPS204836B

Automotive(A3) Range: -40°C to +125°C (vDD = 1.8v / vDDQ = 1.8v)

Speed	x36	x18	Package
200MHz	IS64VVPS204836B-200TQA3	IS64VVPS409618B-200TQA3	100 TQFP, 3CE
	IS64VVPS204836B-200TQ2A3	IS64VVPS409618B-200TQ2A3	100 TQFP, 2CE
	IS64VVPS204836B-200B3A3	IS64VVPS409618B-200B3A3	165 PBGA, 13x15mm
	IS64VVPS204836B-200M3A3	IS64VVPS409618B-200M3A3	165 PBGA, 15x17mm
	IS64VVPS204836B-200B2A3	IS64VVPS409618B-200B2A3	119 PBGA
	IS64VVPS204836B-200TQLA3	IS64VVPS409618B-200TQLA3	100 TQFP, 3CE, Lead-free
	IS64VVPS204836B-200TQ2LA3	IS64VVPS409618B-200TQ2LA3	100 TQFP, 2CE, Lead-free
	IS64VVPS204836B-200B3LA3	IS64VVPS409618B-200B3LA3	165 PBGA, 13x15mm, Lead-free
	IS64VVPS204836B-200M3LA3	IS64VVPS409618B-200M3LA3	165 PBGA, 15x17mm, Lead-free
166MHz	IS64VVPS204836B-166TQA3	IS64VVPS409618B-166TQA3	100 TQFP, 3CE
	IS64VVPS204836B-166TQ2A3	IS64VVPS409618B-166TQ2A3	100 TQFP, 2CE
	IS64VVPS204836B-166B3A3	IS64VVPS409618B-166B3A3	165 PBGA, 13x15mm
	IS64VVPS204836B-166M3A3	IS64VVPS409618B-166M3A3	165 PBGA, 15x17mm
	IS64VVPS204836B-166B2A3	IS64VVPS409618B-166B2A3	119 PBGA
	IS64VVPS204836B-166TQLA3	IS64VVPS409618B-166TQLA3	100 TQFP, 3CE, Lead-free
	IS64VVPS204836B-166TQ2LA3	IS64VVPS409618B-166TQ2LA3	100 TQFP, 2CE, Lead-free
	IS64VVPS204836B-166B3LA3	IS64VVPS409618B-166B3LA3	165 PBGA, 13x15mm, Lead-free
	IS64VVPS204836B-166M3LA3	IS64VVPS409618B-166M3LA3	165 PBGA, 15x17mm, Lead-free
IS64VVPS204836B-166B2LA3	IS64VVPS409618B-166B2LA3	119 PBGA, Lead-free	

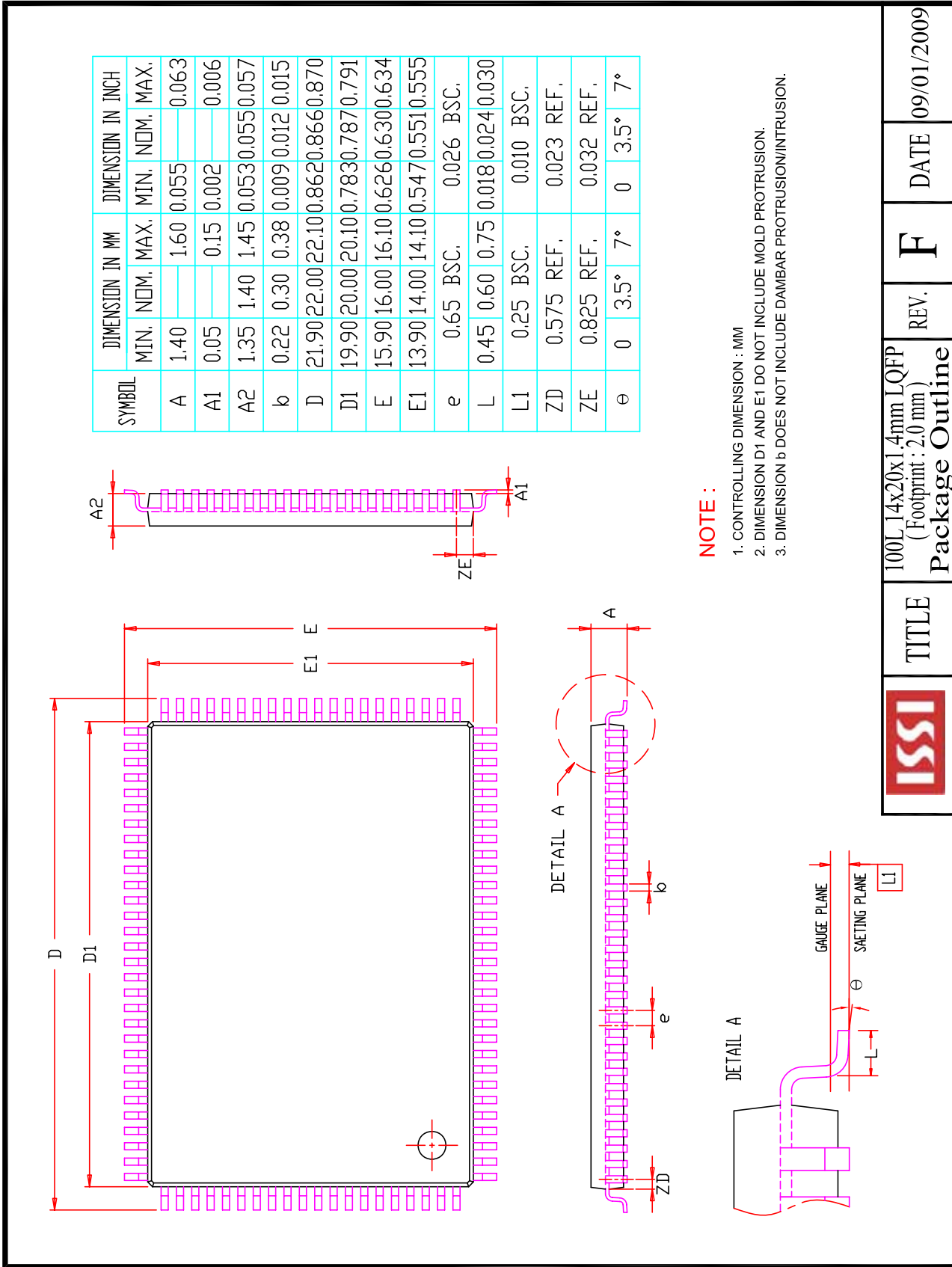

SYMBOL	DIMENSION IN MM		DIMENSION IN INCH	
	MIN.	MAX.	MIN.	MAX.
A	1.40	1.60	0.055	0.063
A1	0.05	0.15	0.002	0.006
A2	1.35	1.45	0.053	0.057
b	0.22	0.38	0.009	0.015
D	21.90	22.00	0.862	0.870
D1	19.90	20.00	0.783	0.791
E	15.90	16.00	0.626	0.634
E1	13.90	14.00	0.547	0.555
e	0.65 BSC.		0.026 BSC.	
L	0.45	0.60	0.018	0.024
L1	0.25 BSC.		0.010 BSC.	
ZD	0.575 REF.		0.023 REF.	
ZE	0.825 REF.		0.032 REF.	
theta	0	3.5°	0	7°

NOTE :

1. CONTROLLING DIMENSION : MM
2. DIMENSION D1 AND E1 DO NOT INCLUDE MOLD PROTRUSION.
3. DIMENSION b DOES NOT INCLUDE DAMBAR PROTRUSION/INTRUSION.

	TITLE	REV.	DATE
	100L14x20x1.4mm LQFP (Footprint : 2.0 mm) Package Outline	F	09/01/2009

280-600-011 REV. A

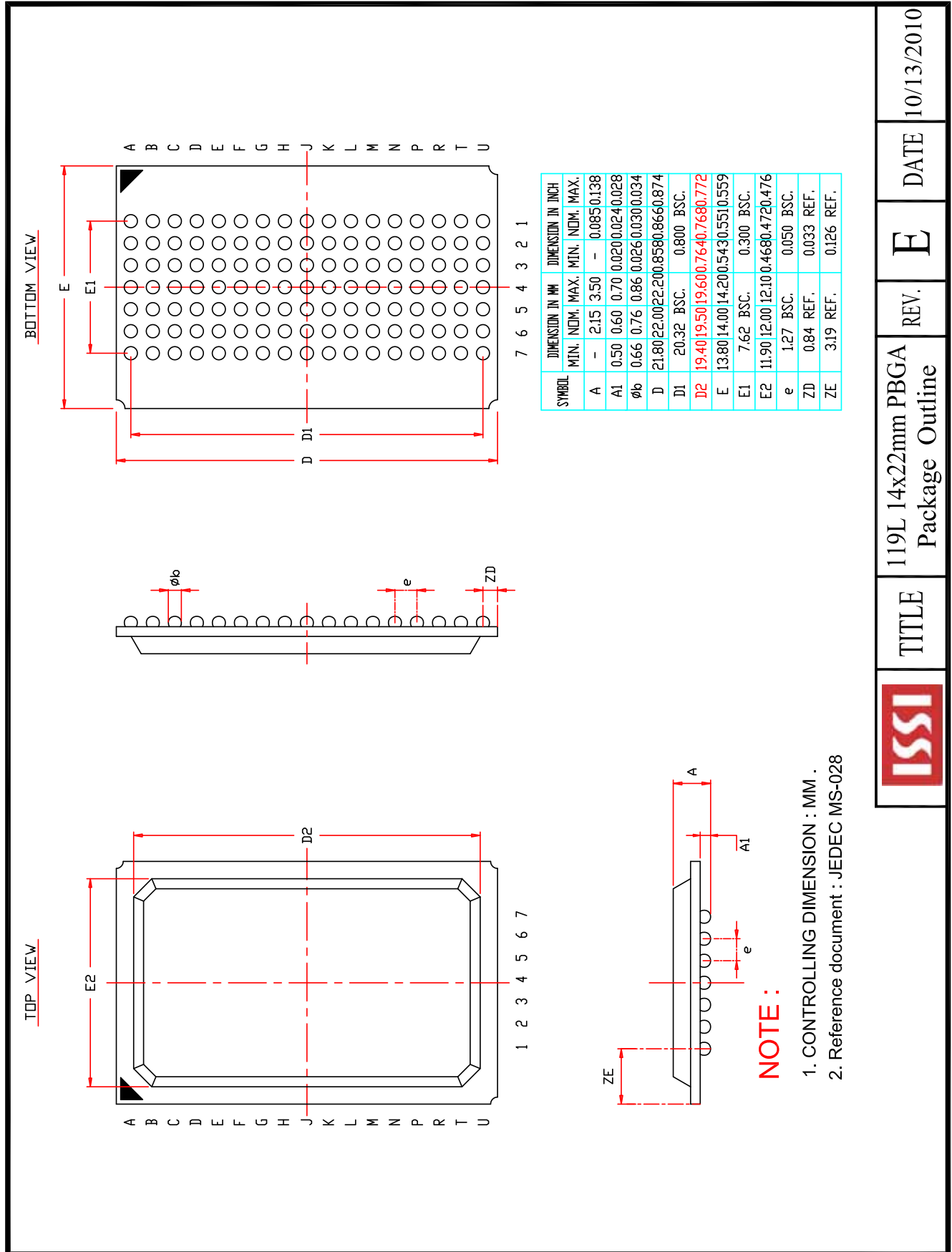

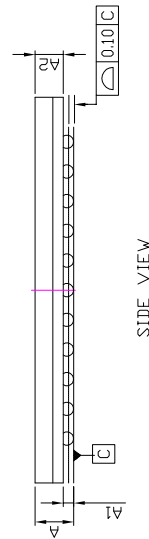
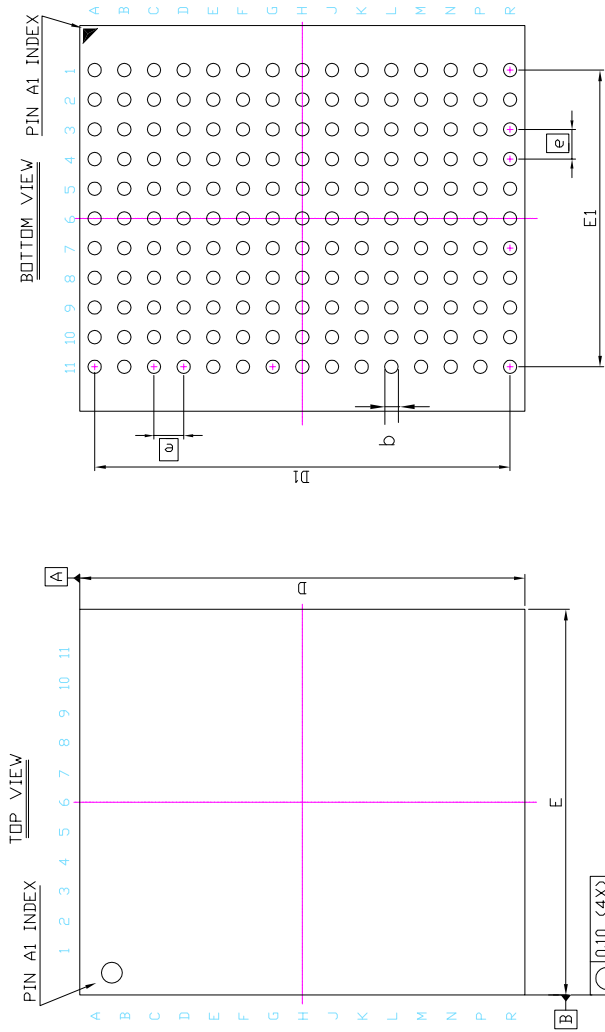

SYM.	DIMENSION (mm)			DIMENSION (inch)		
	MIN.	NDM.	MAX.	MIN.	NDM.	MAX.
A	—	—	1.20	—	—	0.047
A1	0.25	0.35	0.40	0.010	0.014	0.016
A2	—	0.79	—	—	0.031	—
b	0.40	0.45	0.50	0.016	0.018	0.020
D	14.90	15.00	15.10	0.587	0.591	0.594
D1	13.90	14.00	14.10	0.547	0.551	0.555
E	12.90	13.00	13.10	0.508	0.512	0.516
E1	9.90	10.00	10.10	0.390	0.394	0.398
\bar{e}	1.00 BSC			0.039 BSC		

NOTE :

1. CONTROLLING DIMENSION : MM .



TITLE

165L 13x15mm TF-BGA
 Package Outline

REV. B

DATE

08/28/2008

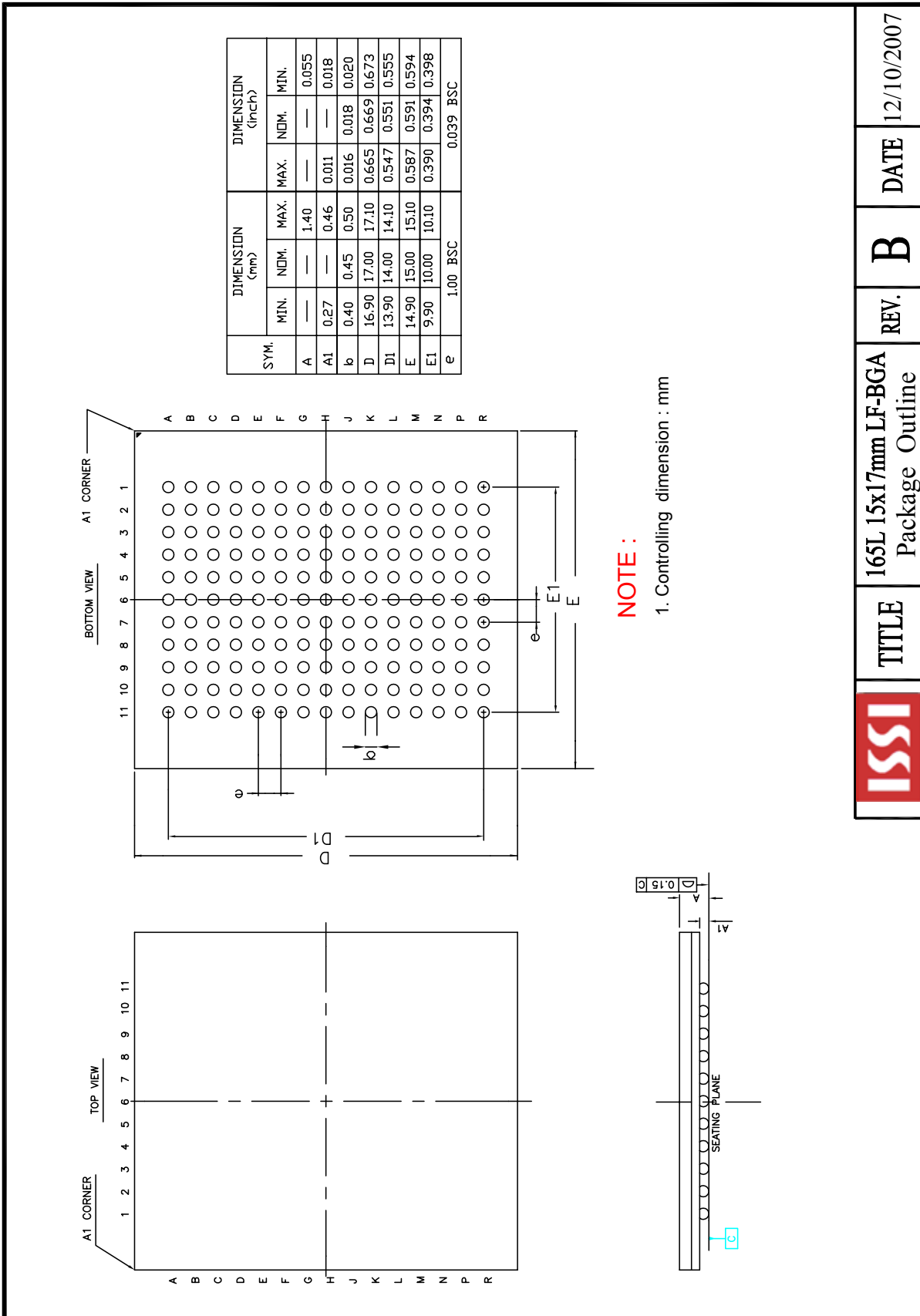

	TITLE	165L 15x17mm LF-BGA Package Outline	REV.	B	DATE	12/10/2007
--	-------	--	------	---	------	------------



**Стандарт
Электрон
Связь**

Мы молодая и активно развивающаяся компания в области поставок электронных компонентов. Мы поставляем электронные компоненты отечественного и импортного производства напрямую от производителей и с крупнейших складов мира.

Благодаря сотрудничеству с мировыми поставщиками мы осуществляем комплексные и плановые поставки широчайшего спектра электронных компонентов.

Собственная эффективная логистика и склад в обеспечивает надежную поставку продукции в точно указанные сроки по всей России.

Мы осуществляем техническую поддержку нашим клиентам и предпродажную проверку качества продукции. На все поставляемые продукты мы предоставляем гарантию .

Осуществляем поставки продукции под контролем ВП МО РФ на предприятия военно-промышленного комплекса России , а также работаем в рамках 275 ФЗ с открытием отдельных счетов в уполномоченном банке. Система менеджмента качества компании соответствует требованиям ГОСТ ISO 9001.

Минимальные сроки поставки, гибкие цены, неограниченный ассортимент и индивидуальный подход к клиентам являются основой для выстраивания долгосрочного и эффективного сотрудничества с предприятиями радиоэлектронной промышленности, предприятиями ВПК и научно-исследовательскими институтами России.

С нами вы становитесь еще успешнее!

Наши контакты:

Телефон: +7 812 627 14 35

Электронная почта: sales@st-electron.ru

Адрес: 198099, Санкт-Петербург,
Промышленная ул, дом № 19, литера Н,
помещение 100-Н Офис 331