

SPOC™+2 User Manual

Multichannel SPI High-Side Power Controller

About this document

Scope and purpose

This User Manual is intended to enable users to integrate the SPOC™+2 Software for the SPOC™+2-Demoboard.

Intended audience

This document is intended for anyone using the SPOC™+2 Software.

Document conventions

Table 1 Conventions

Convention	Explanation
Bold	Emphasizes heading levels, column headings, table and figure captions, screen names, windows, dialog boxes, menus and sub-menus
<i>Italics</i>	Denotes variable(s) and reference(s)
Courier New	Denotes APIs, functions, interrupt handlers, events, data types, error handlers, file/folder names, directories, command line inputs, code snippets

Conventions for reading the configuration class field

The following examples help the integrator to identify the configuration class of the parameter for a given delivery type.

Abbreviations and definitions

Table 2 **Abbreviations**

Abbreviation	Definition
SPOC TM +2	SPI Power Controller
SPOC TM +2 MB	SPOC TM +2 Motherboard
SPOC TM +2 DB	SPOC TM +2 Daughterboard
NC	Not Connected
LHI	Limp Home Input
IS	Sense current

Table of contents

About this document	1
Table of contents	3
Table of figures	4
1 General information	5
1.1 Required hardware	5
1.2 Software Installation	7
1.2.1 SPOC™+2 Application	7
1.2.2 µIO-Stick Driver Install	8
1.3 Setup Hardware	8
1.3.1 Setup details	10
2 Using the software	12
2.1 Starting the program	12
2.2 User Interface	13
2.2.1 STD-View	13
2.2.2 SPI-View	14
2.3 Examples: Command sequences, SPI-View	15
2.3.1 Example 1: Switching on 4 lights step by step with 1 Second delay	15
2.3.2 Example 2: Let one light blink 10 times	19
Revision history	23

Table of figures

Figure 1 – SPOC TM +2 MB	5
Figure 2 – SPOC TM +2 DB	5
Figure 3 - μ O-Stick	6
Figure 4 - Connection cable	6
Figure 5 - Software installation USB-Stick.....	7
Figure 6 – SPOC TM +2 - setup.exe	7
Figure 7 - SPOC TM +2 Application - Select Directory	7
Figure 8 – SPOC TM +2 - Application - Start Installation	8
Figure 9 – SPOC TM +2 - Application – Finish	8
Figure 10 - μ O-Updater (for vCOM)	8
Figure 11 – SPOC TM +2 DB plugged onto SPOC TM +2 MB.....	9
Figure 12 - Connecting μ O-Stick to SPOC TM +2 MB	9
Figure 13 - Finished setup	10
Figure 14 - Device components	11
Figure 15 - SPOC+2 - Application - Finding it	12
Figure 16 – SPOC TM +2 - Application - searching for it	12
Figure 17 - User Interface - STD-View	13
Figure 18 - User Interface - SPI-View	14
Figure 19 - Possible setup	15
Figure 20 - Select register OUT	15
Figure 21 - Write to register OUT	16
Figure 22 - Add command to command list.....	16
Figure 23 - Write OUTo.....	16
Figure 24 - Add to command list	17
Figure 25 - change delay of cammands	17
Figure 26 - repeat until all OUTS (OUTo-OUT ₃) are selected.....	17
Figure 27 - switch to STD view	18
Figure 28 - Select channel at IS MUX.....	18
Figure 29 - Start command sequence	18
Figure 30 - response of SPOC TM +2 to command sequence	19
Figure 31 - Select Register OUT	19
Figure 32 - Select OUTo and add command	20
Figure 33 - Select no output and add command	20
Figure 34 - change delay of commands	21
Figure 35 - change number of command sequences iterations	21
Figure 36 - Switch to STD view	21
Figure 37 - Select a channel at IS MUX.....	22
Figure 38 - Switch to SPI and start command sequence	22
Figure 39 - Response od SPOC TM +2 in response list.....	22

1 General information

1.1 Required hardware

First of all some special hardware is needed:

- SPOC™+2 MB
 - SPOC™+2 Motherboard
 - See Figure 1



Figure 1 – SPOC™+2 MB

- SPOC™+2 DB
 - Product specific (BTSxxxxx-xxxx)
 - See Figure 2



Figure 2 – SPOC™+2 DB

- **μIO-Stick**
 - Communication between your computer and the Demoboard
 - Isar Number: SP001215532
 - See Figure 3



Figure 3 - μIO-Stick

- **Connection cable**
 - Ribbon cable
 - 16 pin female connector
 - See figure 4

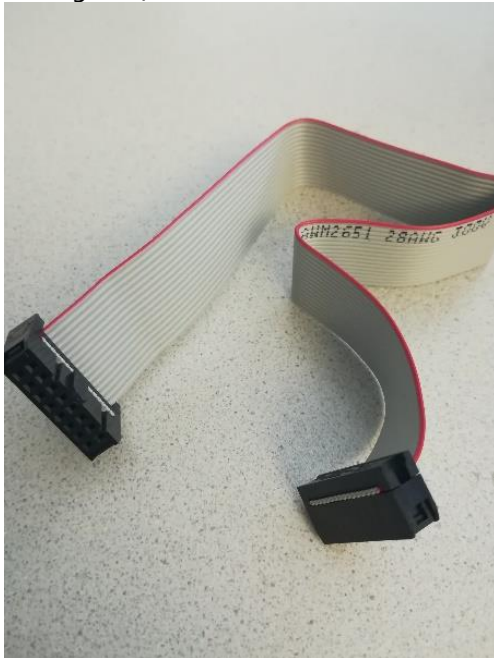

Figure 4 - Connection cable

- USB-Stick
 - For software installation
 - See Figure 5



Figure 5 - Software installation USB-Stick

1.2 Software Installation

1.2.1 SPOC™+2 Application

How to install software for the SPOC™+2 Evaluation Board:

- Plug in the Software-USB-Stick into a USB port of your computer
- Run **setup.exe** in the following location:
 - **USB-Drive:\SPOC+2_Installer\Volume\setup.exe** (see Figure 6)

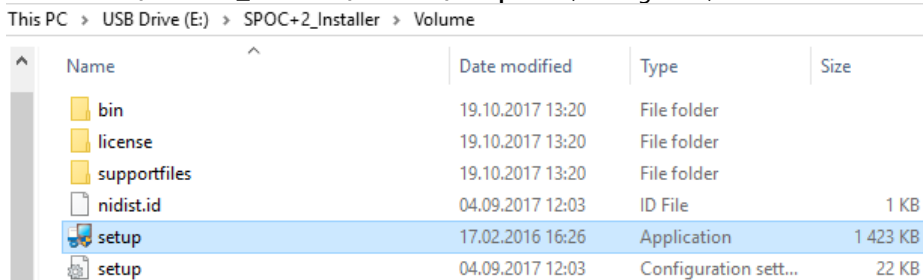

Figure 6 – SPOC™+2 - setup.exe

- Note: You must log in as administrator!
- Follow the steps of the Installation Wizard (see Figures below):
 - Select installation directory, then click “next”

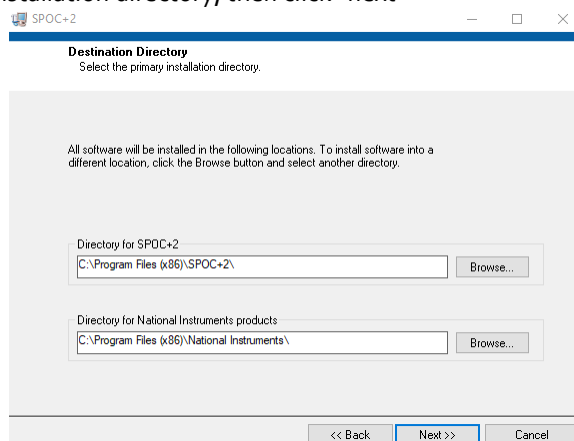

Figure 7 - SPOC™+2 Application - Select Directory

- Again click “next”

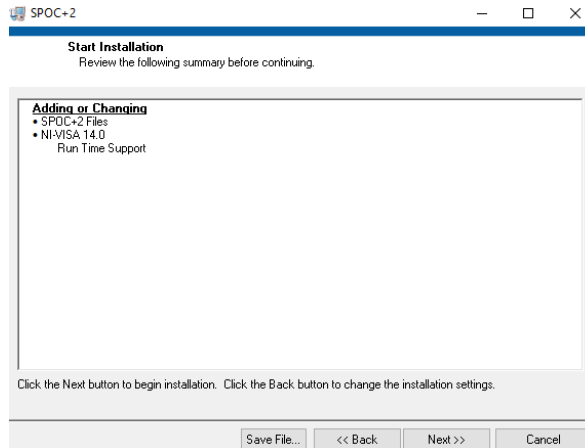

Figure 8 – SPOC™+2 - Application - Start Installation

- The installation will start, after that click „finish“

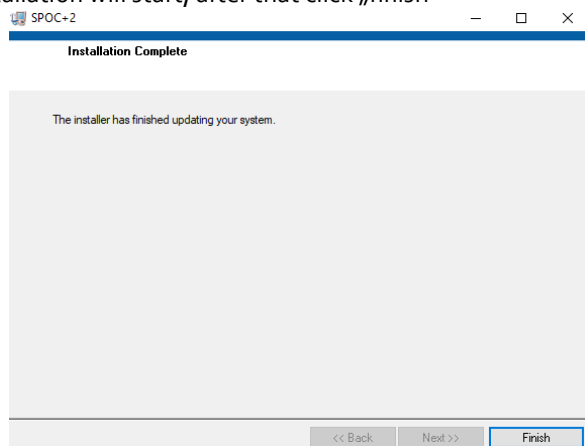

Figure 9 – SPOC™+2 - Application – Finish

1.2.2 μIO-Stick Driver Install

After installing the SPOC™+2-Application keep the Software-USB plugged in and plug in the μIO-Stick. In order to use the virtual COM-port (necesairy for the application) go to <https://www.ehitex.de/usb-application-sticks/infineon/2529/uio-stick>, scroll to **Available Downloads** and select **Download uIO Updater (zip file)** see Figure 10. Extract the zip file and run *UpdatePEK* afterwards.

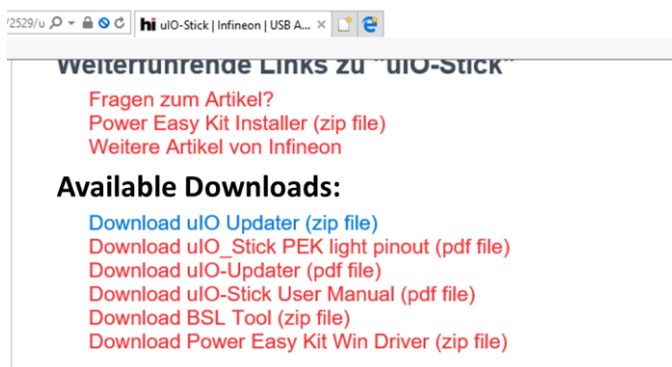

Figure 10 - uIO-Updater (for vCOM)

1.3 Setup Hardware

- Plug the SPOC™+2 DB onto the SPOC™+2 MB (see Figure 11)

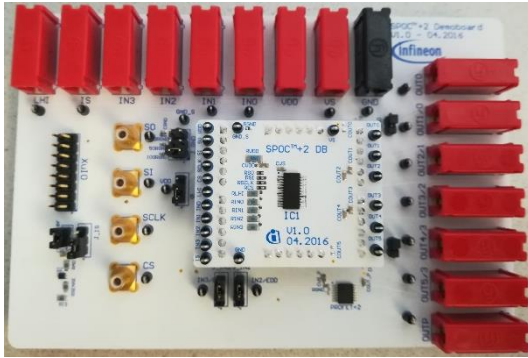

Figure 11 – SPOC™+2 DB plugged onto SPOC™+2 MB

- Connect the μ O-Stick to the SPOC™+2 MB via the connector cable (see Figure 12)
 - **Be careful:** Position of Pin 1 is marked with a dot on the SPOC™+2 MB!

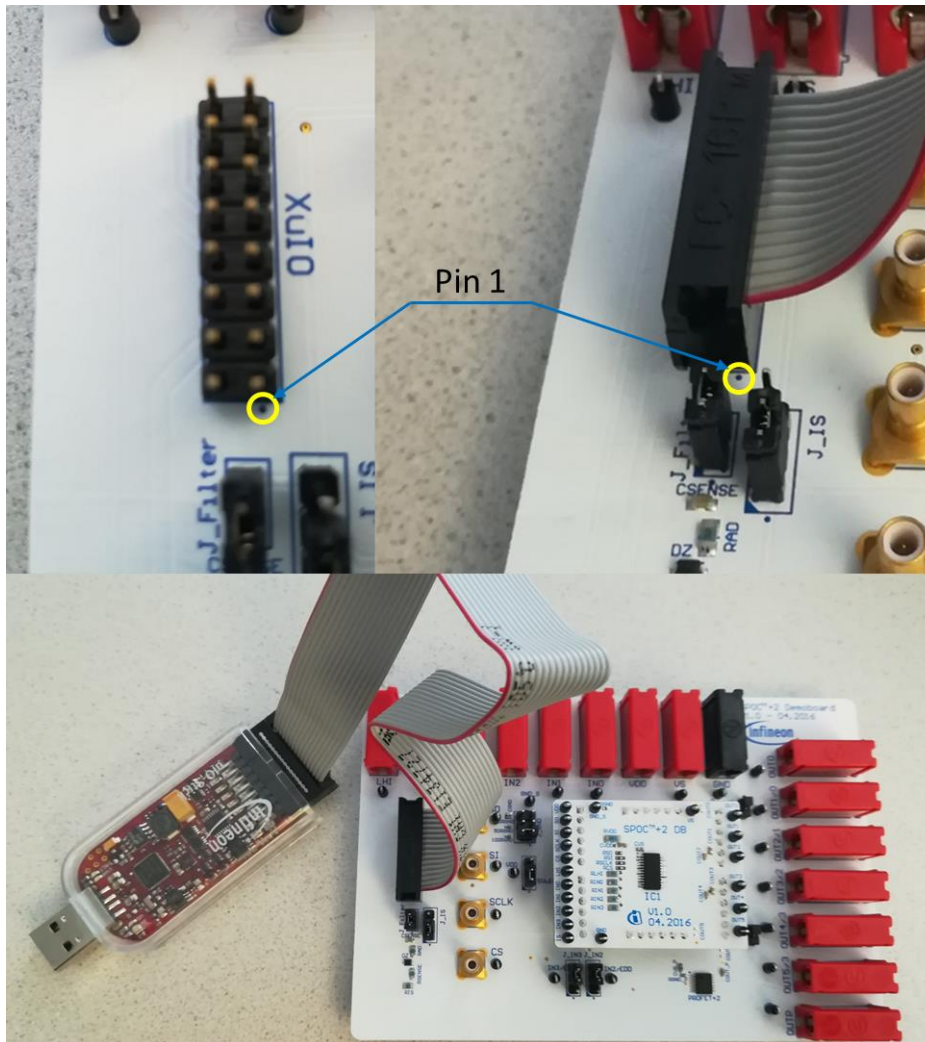

Figure 12 - Connecting μ O-Stick to SPOC™+2 MB

- Connect the μ O-Stick to your computer and run the SPOC™+2-Application. (see Figure 13)

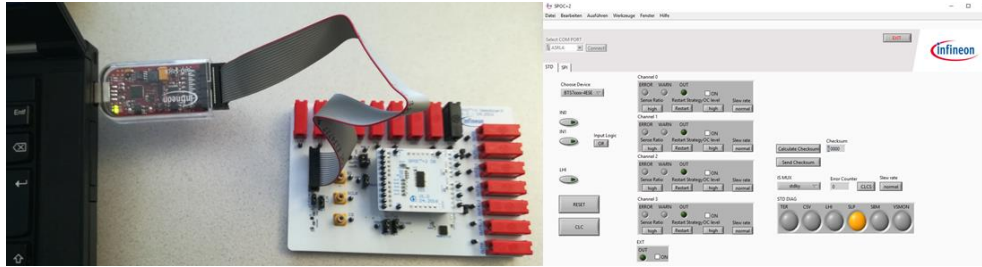

Figure 13 - Finished setup

1.3.1 Setup details

Table 3	
X μ IO	
Pin #	
○ 1	NC
○ 2	GND
○ 3	NC
○ 4	+5V μ IO
○ 5	NC
○ 6	NC
○ 7	NC
○ 8	IN ₃
○ 9	CS
○ 10	IN ₂
○ 11	SCLK
○ 12	IN ₁
○ 13	SO
○ 14	IN ₀
○ 15	SI
○ 16	Sense
J_Filter	Closed by default
J_IS	1-2 closed by default If 2-3 is closed: <ul style="list-style-type: none"> • J_Filter has to be opened! • Sense directly switched to IS (Filter disconnected)
J_GND	1-2 closed: R_GND = 150 Ω (default) 3-4 closed: R_GND = 50 Ω 5-6 closed: R_GND = 0 Ω
J_IN₂	3-2 closed by default. If 1-2 is closed: <ul style="list-style-type: none"> • Connect PROFET ²
J_IN₃	3-2 closed by default. If 1-2 is closed: <ul style="list-style-type: none"> • Connect PROFET ²
J_VDD	1-2 closed (default VDD via μ IO-Stick): <ul style="list-style-type: none"> • Use +5VμIO (USB) as digital supply voltage 2-3 closed: <ul style="list-style-type: none"> • VDD via external supply
J_cho ¹	Closed if 4 Channel SPOC TM +2 is used:

	<ul style="list-style-type: none"> • OUT₀ and OUT_{1/0} in parallel.
J_ch ₃ ¹	Closed if 4 Channel SPOC+2 is used: <ul style="list-style-type: none"> • OUT_{4/3} and OUT_{5/3} in parallel.
SO	Slave Out (SPI Interface)
SI	Slave In (SPI Interface)
SCLK	Serial Clock (SPI Interface)
CS	Chip Select (SPI Interface)
IN ₀	activate the corresponding output channel
IN ₁	activate the corresponding output channel
IN ₂ /EDD ²	activate the corresponding output channel
IN ₃ /EDO ²	activate the corresponding output channel
OUT ₀	Output channel 0
OUT _{1/0} ¹	Output channel 1 if J_cho is open, Output channel 0 if J_cho is closed
OUT _{2/1} ¹	Output channel 2 if J_cho is open, Output channel 1 if J_cho is closed
OUT _{3/2} ¹	Output channel 3 if J_cho is open, Output channel 2 if J_cho is closed
OUT _{4/3} ¹	Output channel 4 if J_ch ₃ is open, Output channel 3 if J_ch ₃ is closed
OUT _{5/3} ¹	Output channel 5 if J_ch ₃ is open, Output channel 3 if J_ch ₃ is closed
OUTP	Output PROFET ²
IS	Sense current
LIH	Limp Home Input
VDD	Digital supply voltage
GND	Ground
VS	Supply voltage

¹ If 4-Channel-SPOC™ are used J_cho and J_ch₃ had to be closed, otherwise (6-Channel-SPOC) opened.

² If Jumpers J_IN₂ and J_IN₃ are set to 1-2: SPOC™ Outputs EDD and EDO can control the PROFET.

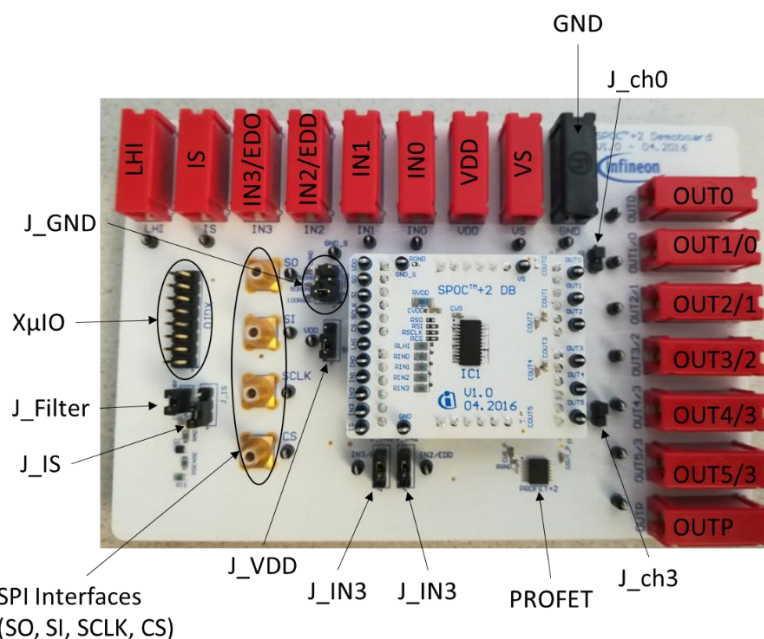

Figure 14 - Device components

2 Using the software

2.1 Starting the program

- Installed Application can be found in the windows start menu in the section "all programs" → "SPOC+2" → SPOC+2 (see Figure 15):

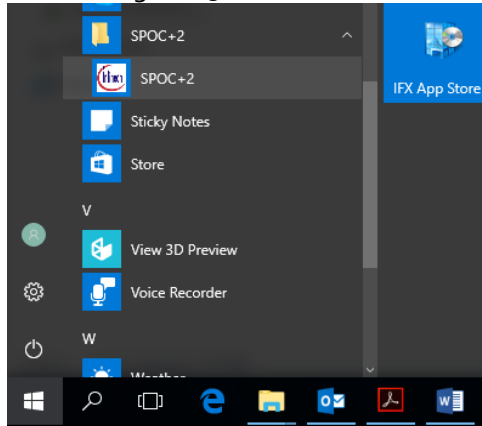

Figure 15 - SPOC+2 - Application - Finding it

or by using the search bar (see Figure 16):

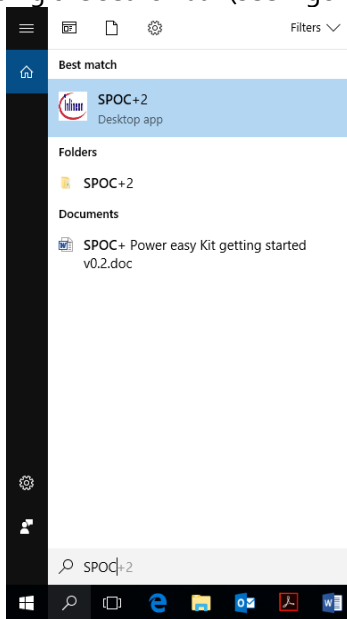

Figure 16 – SPOC™+2 - Application - searching for it

- Run the program by clicking on the file (see Figures 15 and 16)

2.2 User Interface

2.2.1 STD-View

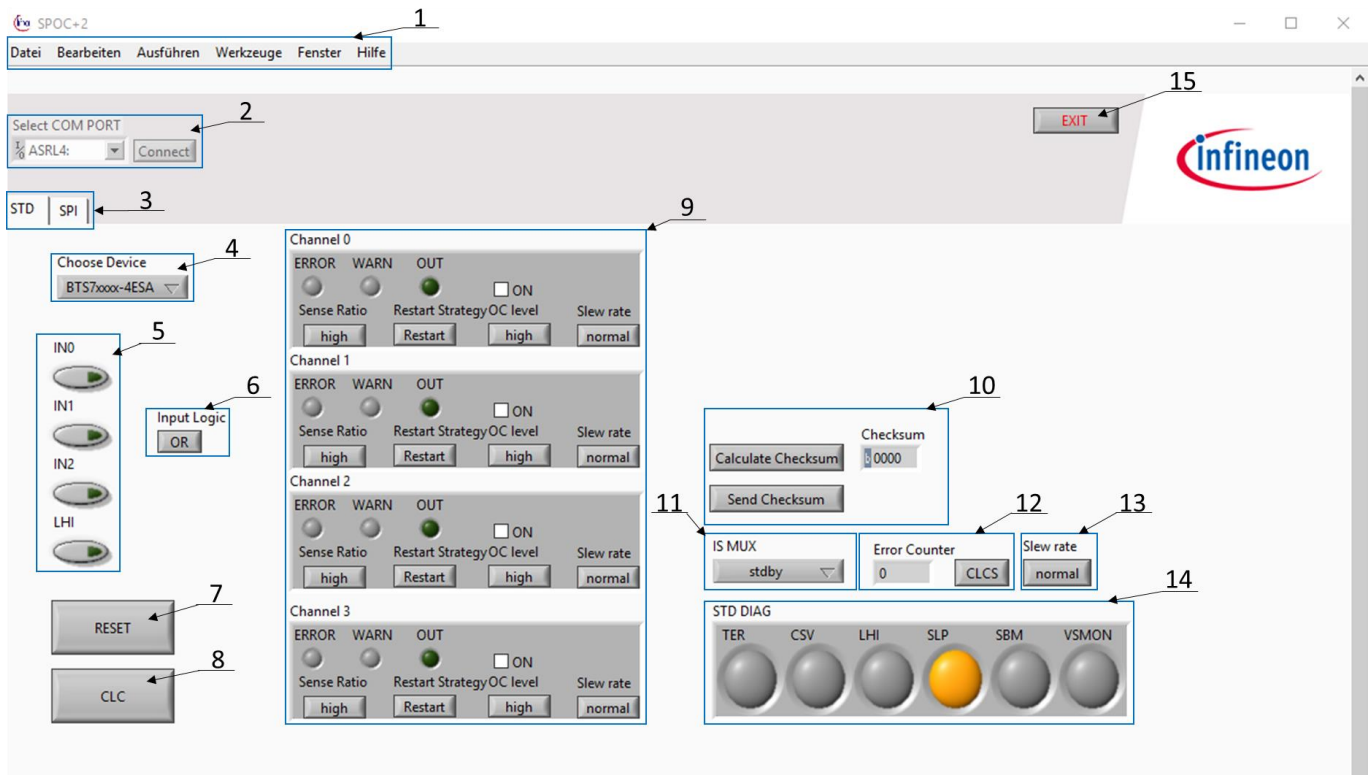

Figure 17 - User Interface - STD-View

Table 4 - STD-View

Number	Element	Description
1	Menu bar	*
2	Port selection	Software should detect the Comport automatically. <ul style="list-style-type: none"> If not: select the needed Comport.
3	Standard or SPI view	Change between a button based control(Figure 17) and a low level SPI command control(Figure 18)
4	Device selection	Select the used device type
5	Direct inputs and LHI	<ul style="list-style-type: none"> Switch IN0-IN2 on or off LHI can be set on or off
6	Input logics	OR/AND operation between direct inputs (IN0-IN3) with the channel's on-status (channel 0 to 3)
7	Reset	Reset SPOC TM +2
8	Clear	Clear all Error latches and error counter
9	Channels	Indicates the Status of a channel (Error, Warn, OUT, Slew rate) and configures the channel (ON, Sense ratio, Restart Strategy, OC level) <ul style="list-style-type: none">
10	Checksum	Shows the calculated checksum reflecting the configuration. This value will be transmitted when clicking on send checksum.
11	IS MUX	Configure the mux setting. For more information see datasheet of SPOC TM +2
12	Error counter	Error counter of the selected channel <ul style="list-style-type: none">
13	Slew rate settings	configures the slew rate of the selected channel
14	Status display	Visualizes the standard diagnosis (spi response)
15	Exit button	Closes connection and program

2.2.2 SPI-View

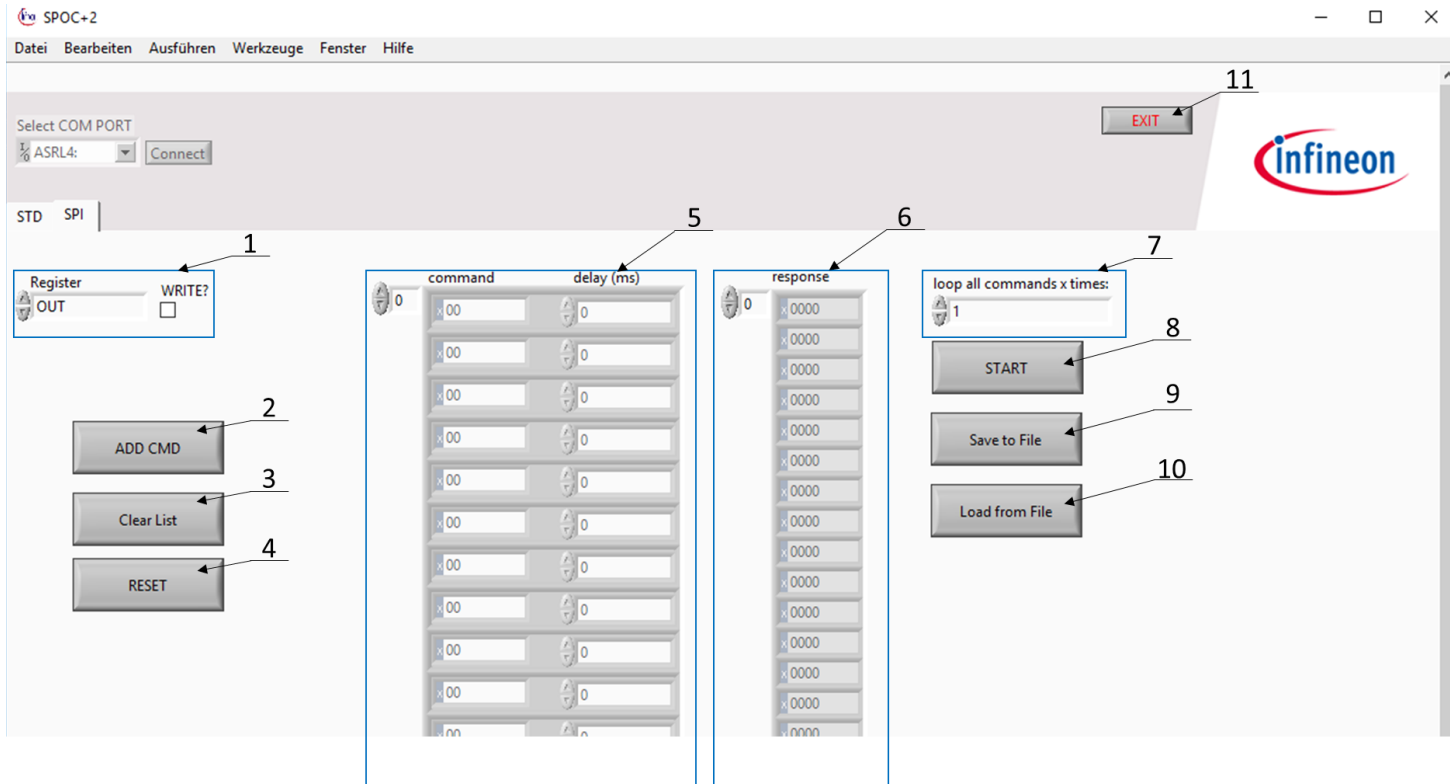

Figure 18 - User Interface - SPI-View

Number	Function	Description
1	Register selection	Select the register address and in case WRITE is enabled the content for the next spi command. If WRITE is disabled a read command will be added.
2	Add command	Adds the composed command to the command list (see 8)
3	Clear command list	Clears the content of the command list
4	Reset	Resets SPOC™+2
5	Command list	Displays all added commands in ascending order
6	Response list	Displays SPOC™+2's response to the currently processed command (see datasheet of the used SPOC™+2)
7	Loop configuration	Commands are embedded in a loop Change the number of iterations (default is 1)
8	Start button	Starts the command sequence resp. the loop
9	Save to file	Saves the command sequence to a file
10	Load from File	Loads a saved command sequence from a file
11	Exit button	Closes connection and program

*...menu description not necessary at the moment → Tobias

2.3 Examples: Command sequences, SPI-View

Figure 19 below illustrates a possible test setup. The examples in 2.3.1 and 2.3.2 refer to this setup.

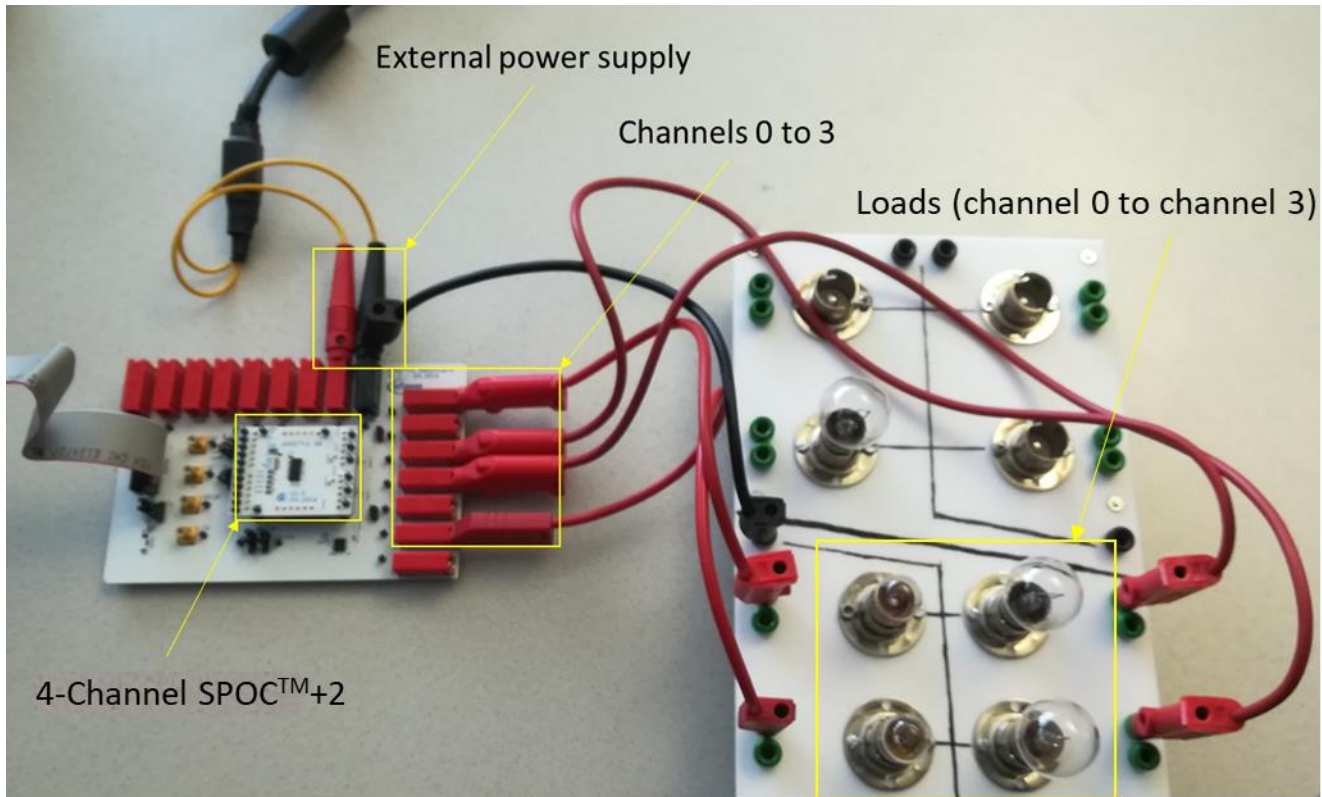

Figure 19 - Possible setup

2.3.1 Example 1: Switching on 4 lights step by step with 1 Second delay

- Switch to SPI view and select register OUT (See Figure 20)

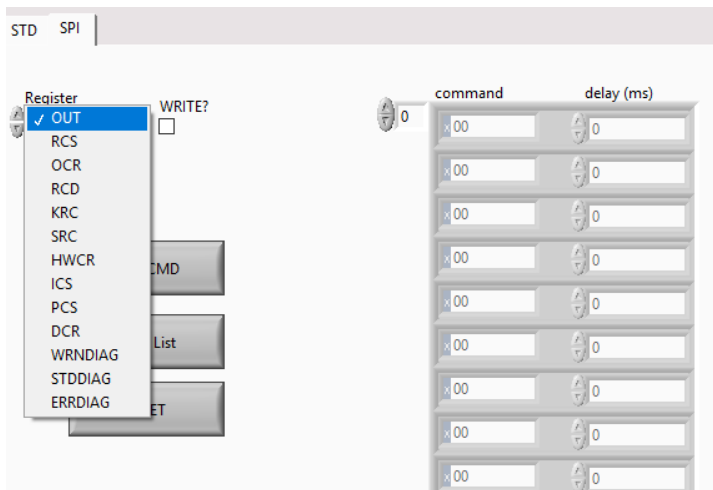

Figure 20 - Select register OUT

- Tick the WRITE?-Box and select no Output (See Figure 21)

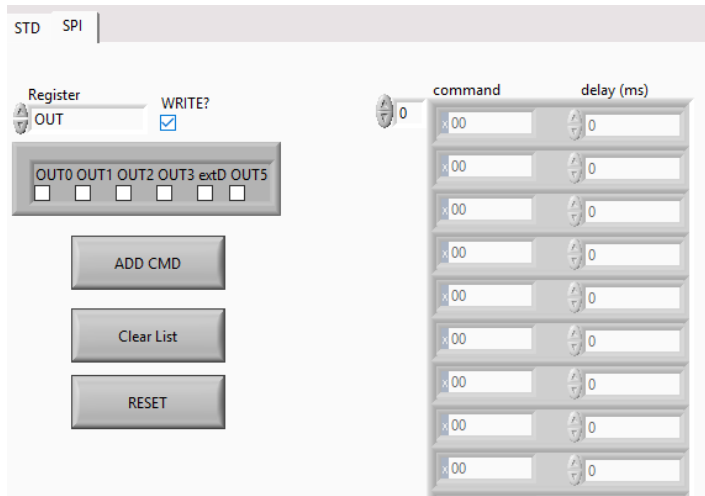

Figure 21 - Write to register OUT

- Click ADD CMD and your command is added to the command list (See Figure 22)

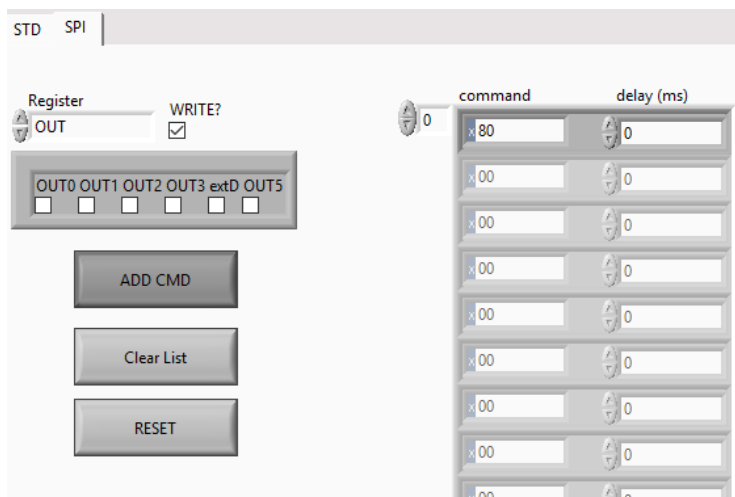

Figure 22 - Add command to command list

- Select OUT0 in the WRITE-Box (See Figure 23)

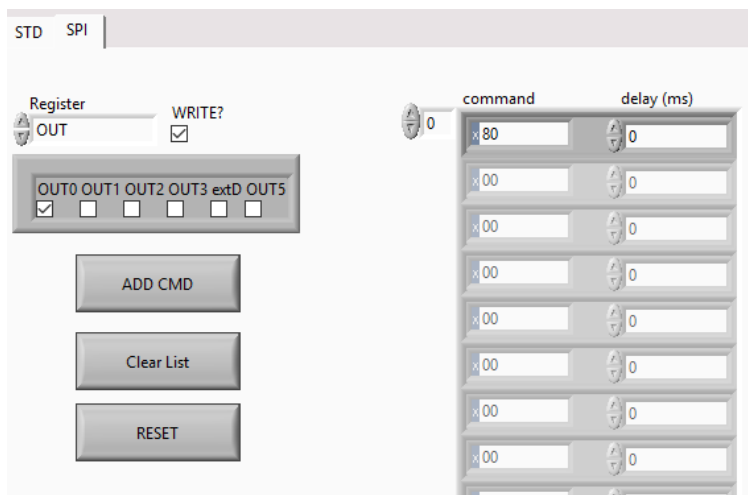

Figure 23 - Write OUT0

- Click ADD CMD (See Figure 24)

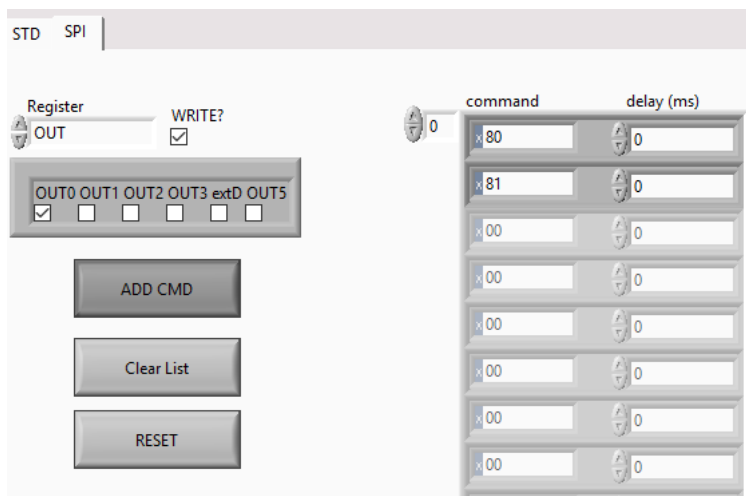

Figure 24 - Add to command list

- Change the delay of each command to 1000 (delay of 1 second, See Figure 25)

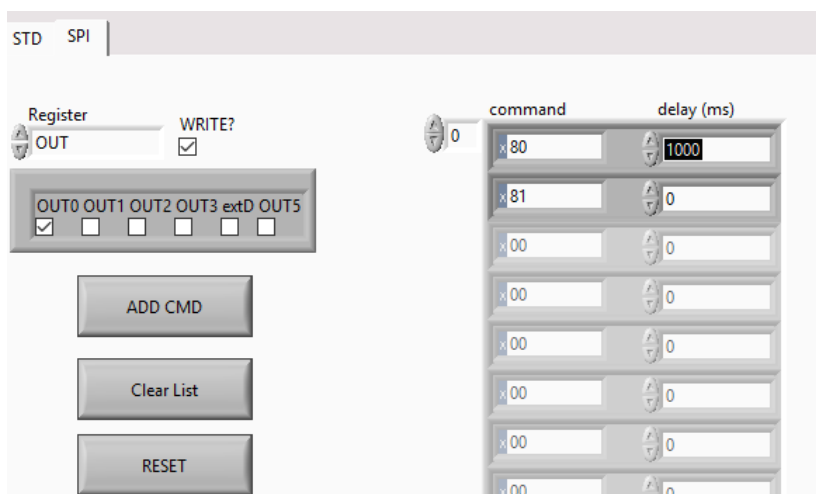

Figure 25 - change delay of cammands

- Repeat the last three steps until you reach OUT₃ (See Figure 26)

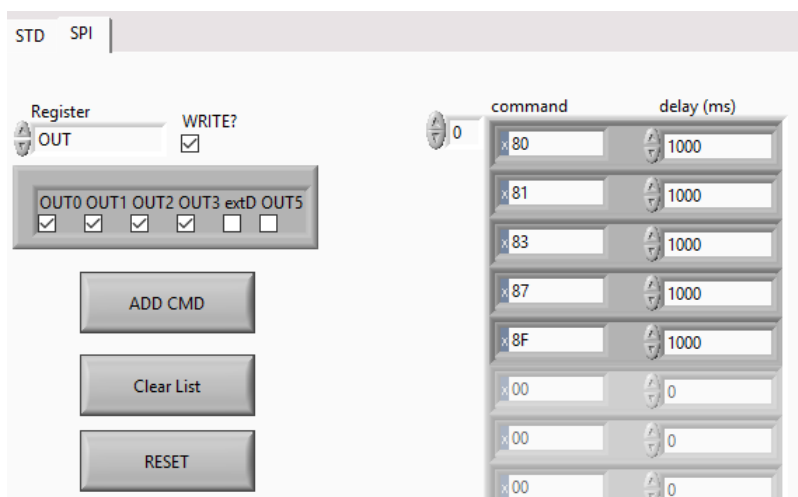

Figure 26 - repeat until all OUTS (OUT0-OUT3) are selected

- Switch to STD view (See Figure 27) and select a channel (0 – 3) at IS MUX (See Figure 28)

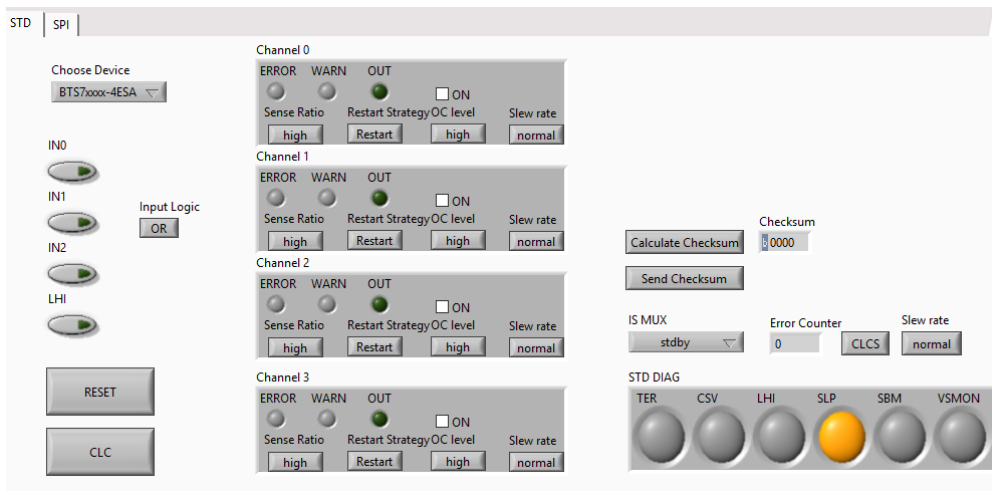

Figure 27 - switch to STD view

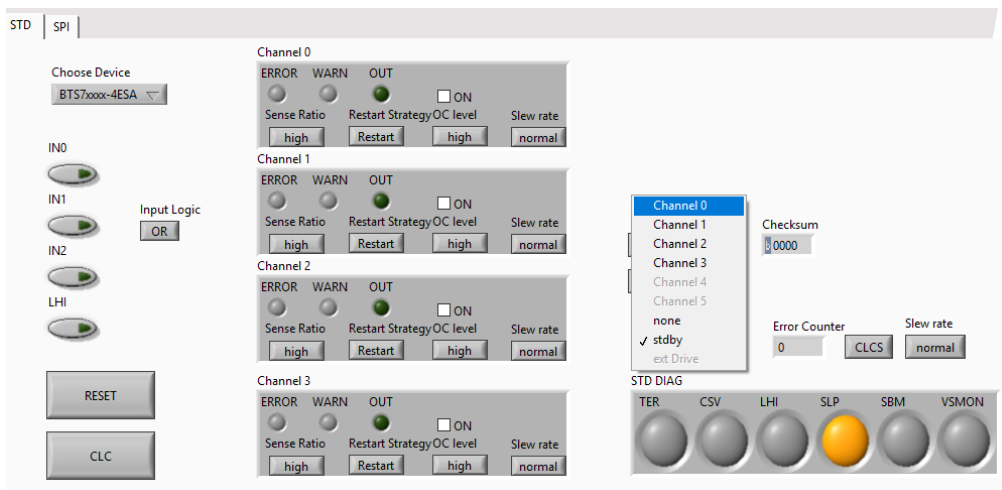

Figure 28 - Select channel at IS MUX

- Switch back to SPI view and click the START-button (See Figure 29)

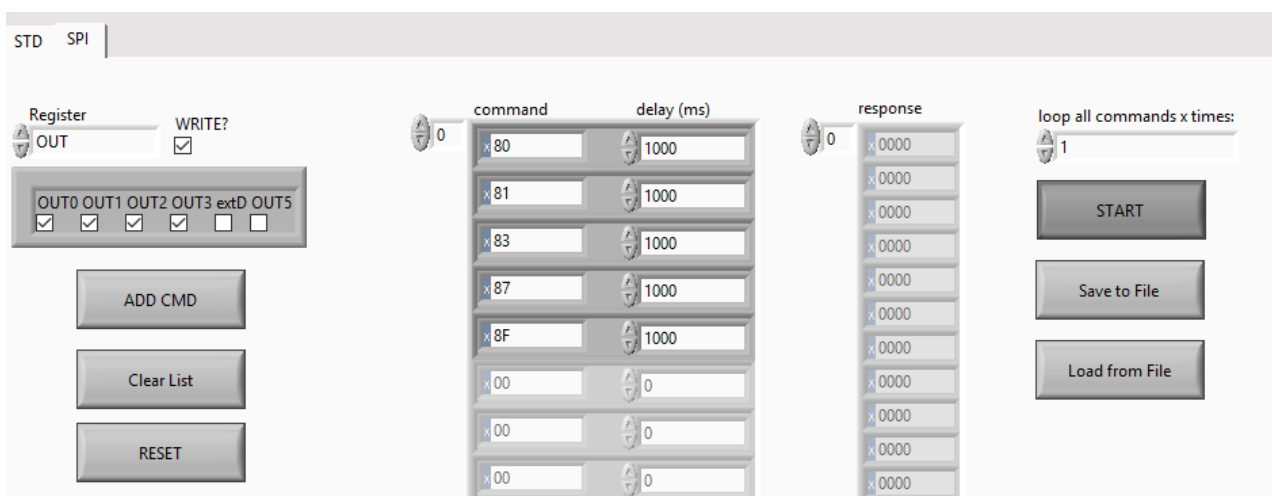

Figure 29 - Start command sequence

- The response of the SPOCTM+2 is shown in the response list (See Figure 30)

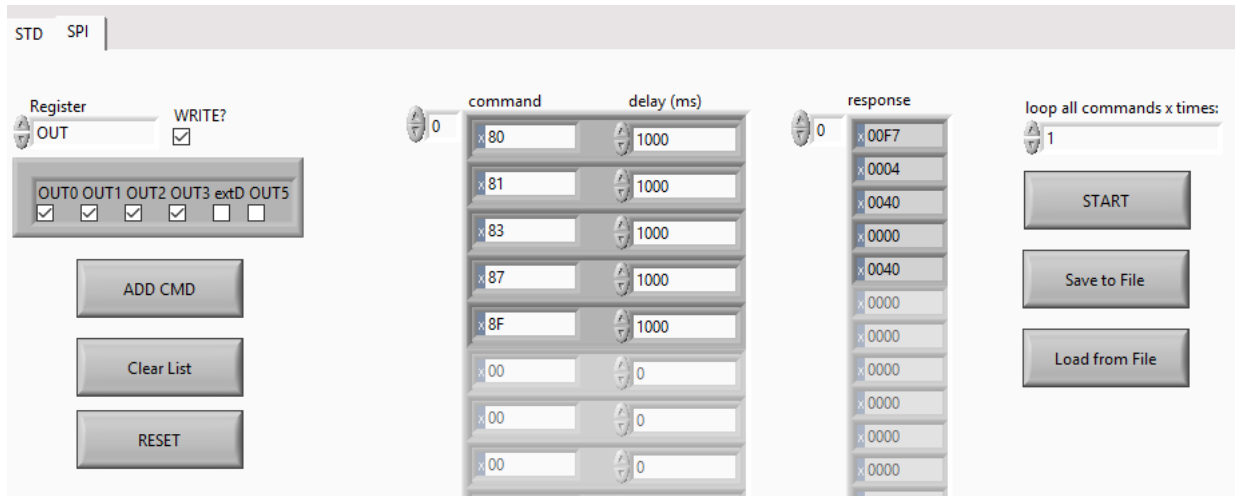

Figure 30 - response of SPOCTM+2 to command sequence

2.3.2 Example 2: Let one light blink 10 times

	Description	t [ms]
T_ON	Duration light on	500
T_OFF	Duration light off	500

- Switch to SPI view and select register OUT (See Figure 31)

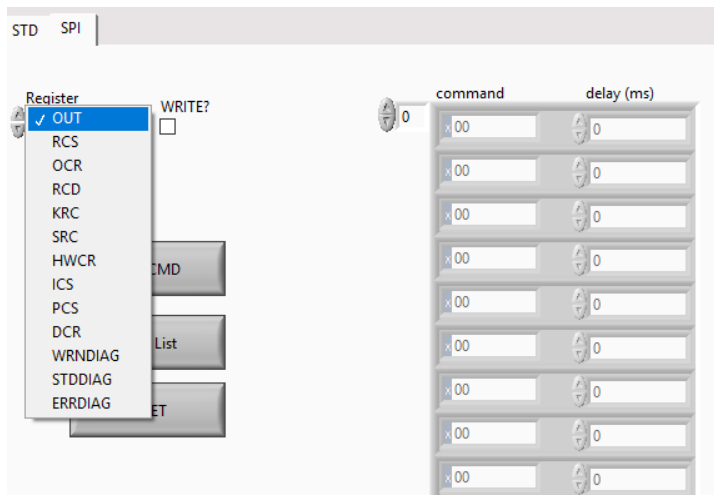

Figure 31 - Select Register OUT

- Tick the WRITE?-Box and select OUT0 and click ADD CMD (See Figure 32)

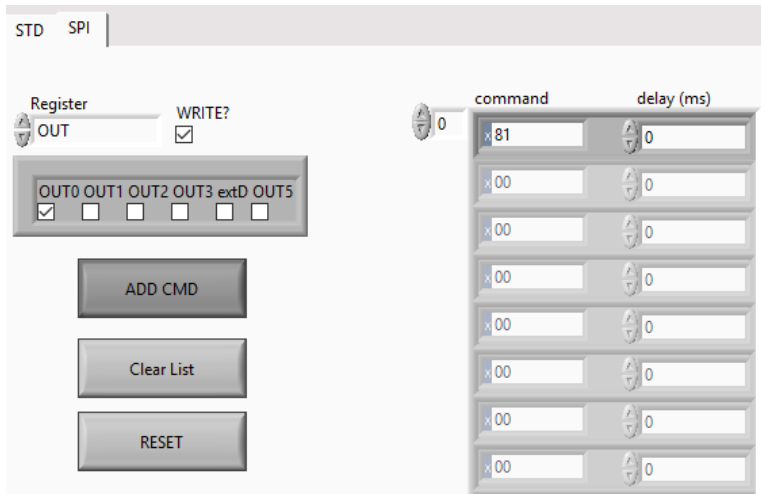

Figure 32 - Select OUT0 and add command

- Select no output in the WRITE-Box and click ADD CMD (See Figure 33)

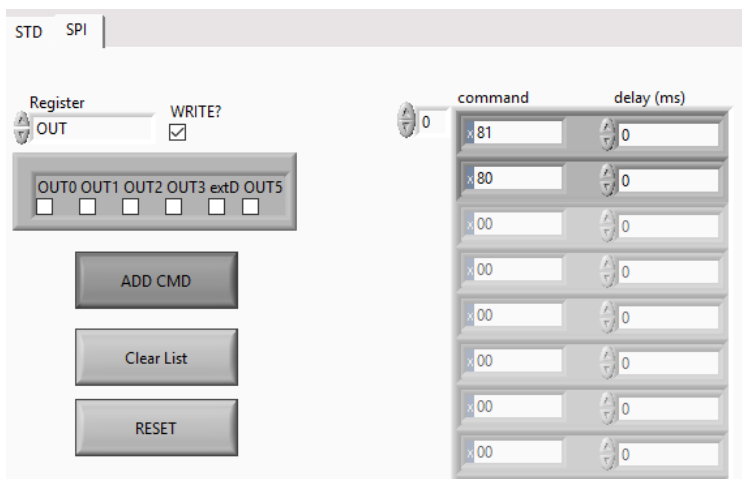

Figure 33 - Select no output and add command

- Also typing in commands directly is possible (See SPOC™+2 datasheet for command reference)
 - E.g.:
 - The command 80_h means *Write no output to OUT*
 - The command 81_h would mean *Write to OUT and set OUT to high.*
 - See Figure 32 above
- Change the delay of command 81 to T_ON, the delay of command 80 to T_OFF (See Figure 34)

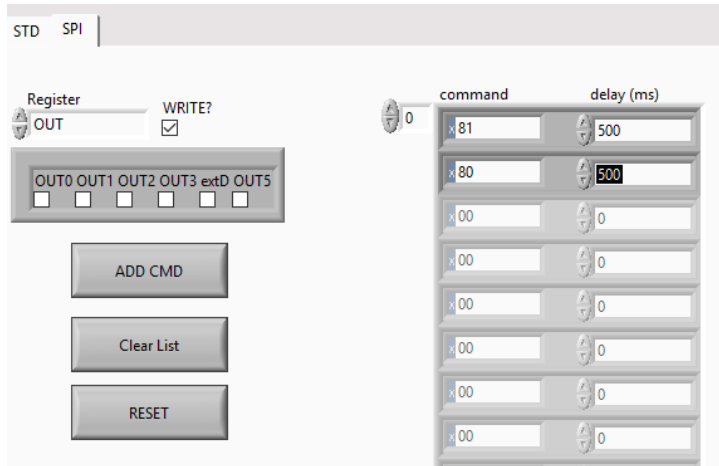

Figure 34 - change delay of commands

- Change loop all commands x times to 10 (See Figure 35)

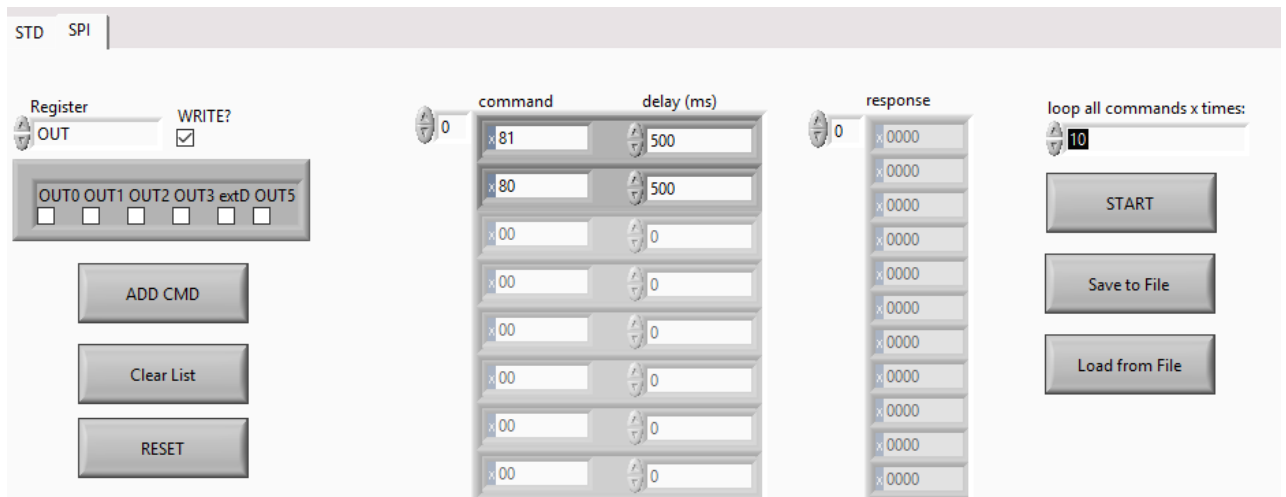

Figure 35 - change number of command sequences iterations

- Switch to STD view (See Figure 36) and select a channel (0 – 3) at IS MUX (See Figure 37)

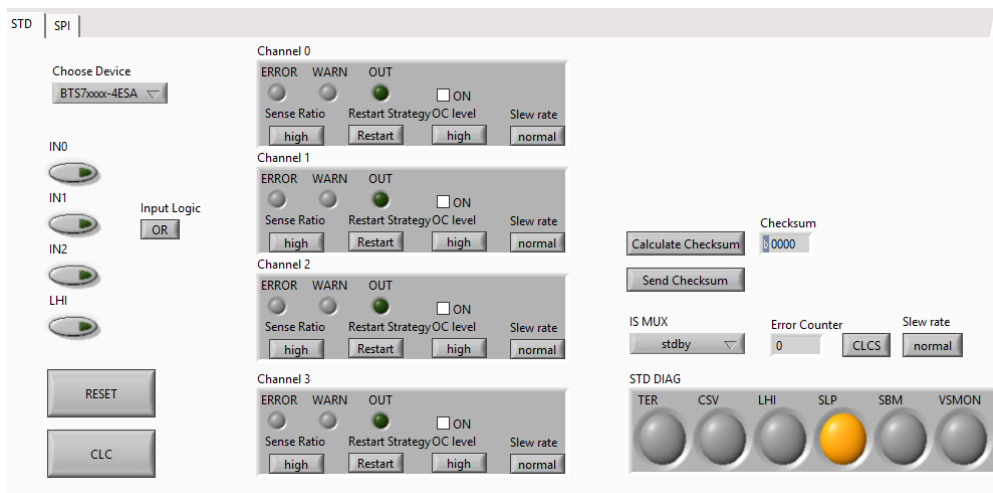

Figure 36 - Switch to STD view

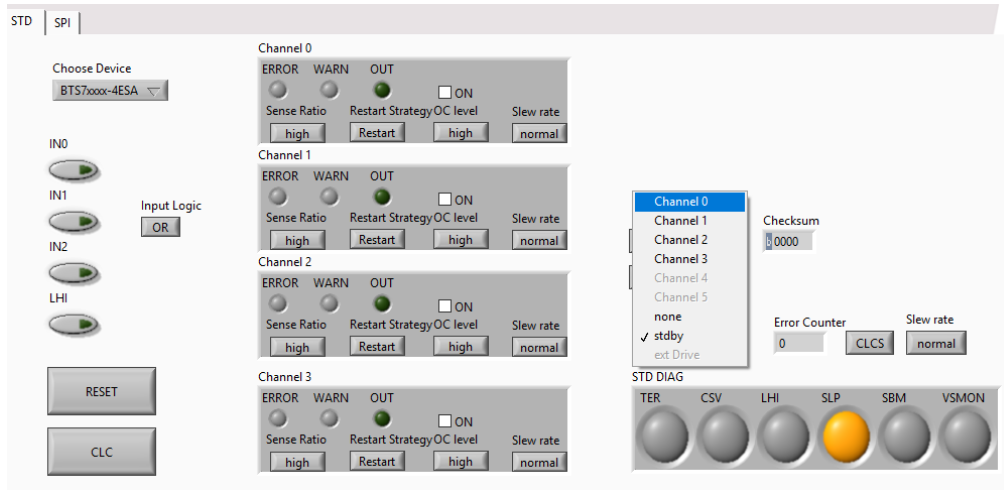

Figure 37 - Select a channel at IS MUX

- Switch back to SPI view and click the START-button (See Figure 38)

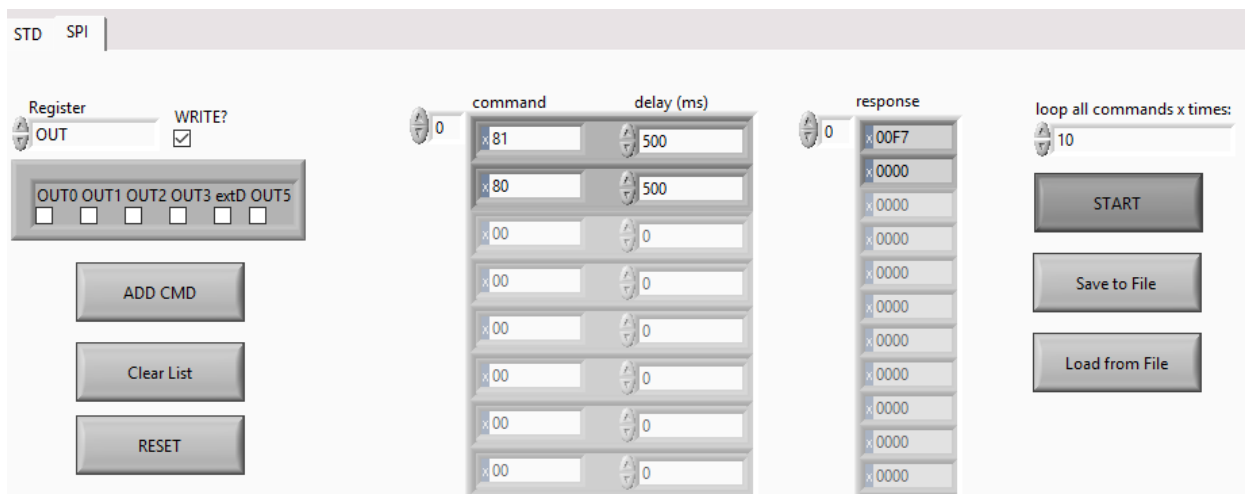

Figure 38 - Switch to SPI and start command sequence

- The response of the SPOC™+2 is shown in the response list (See Figure 39)

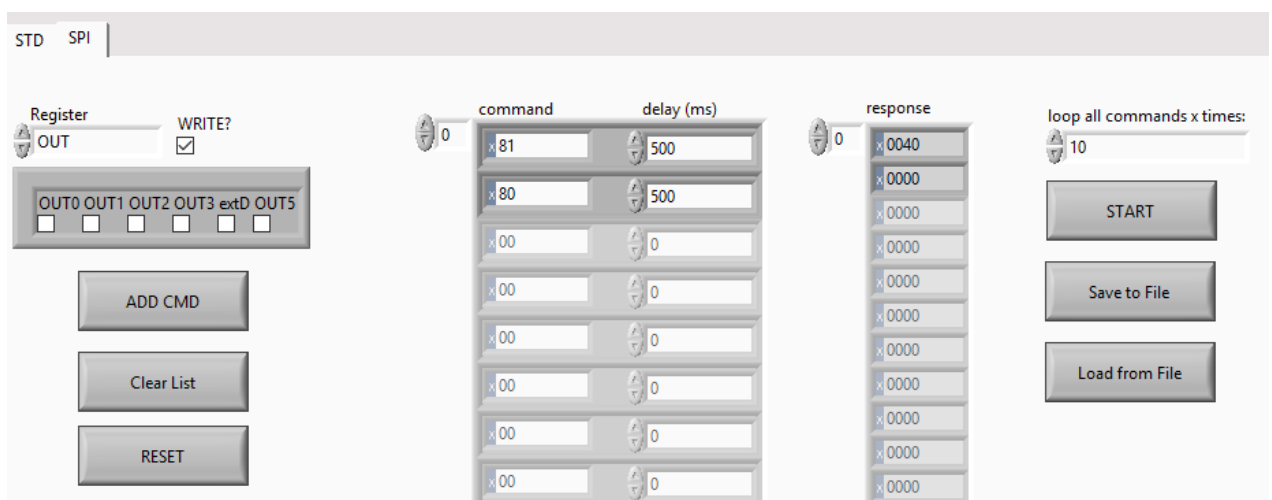

Figure 39 - Response of SPOC™+2 in response list



Revision history

Major changes since the last revision

Date	Version	Description

Template revision history

Note: *The below table is for reference purpose only. Delete this table before circulation.*

Changes since the last revision

Date	Version	Author	Description
11-2017	1.0	Rasser René	Initial released version

Trademarks

All referenced product or service names and trademarks are the property of their respective owners.

Edition <yyyy-mm>
Published by

Infineon Technologies AG
81726 Munich, Germany

© 2018 Infineon Technologies AG.
All Rights Reserved.

Do you have a question about this
document?

Email: erratum@infineon.com

Document reference
Doc_Number

IMPORTANT NOTICE

The information given in this document shall in no event be regarded as a guarantee of conditions or characteristics ("Beschaffenhheitsgarantie").

With respect to any examples, hints or any typical values stated herein and/or any information regarding the application of the product, Infineon Technologies hereby disclaims any and all warranties and liabilities of any kind, including without limitation warranties of non-infringement of intellectual property rights of any third party.

In addition, any information given in this document is subject to customer's compliance with its obligations stated in this document and any applicable legal requirements, norms and standards concerning customer's products and any use of the product of Infineon Technologies in customer's applications.

The data contained in this document is exclusively intended for technically trained staff. It is the responsibility of customer's technical departments to evaluate the suitability of the product for the intended application and the completeness of the product information given in this document with respect to such application.

For further information on the product, technology, delivery terms and conditions and prices please contact your nearest Infineon Technologies office (www.infineon.com).

WARNINGS

Due to technical requirements products may contain dangerous substances. For information on the types in question please contact your nearest Infineon Technologies office.

Except as otherwise explicitly approved by Infineon Technologies in a written document signed by authorized representatives of Infineon Technologies, Infineon Technologies' products may not be used in any applications where a failure of the product or any consequences of the use thereof can reasonably be expected to result in personal injury.



Стандарт Электрон Связь

Мы молодая и активно развивающаяся компания в области поставок электронных компонентов. Мы поставляем электронные компоненты отечественного и импортного производства напрямую от производителей и с крупнейших складов мира.

Благодаря сотрудничеству с мировыми поставщиками мы осуществляем комплексные и плановые поставки широчайшего спектра электронных компонентов.

Собственная эффективная логистика и склад в обеспечивает надежную поставку продукции в точно указанные сроки по всей России.

Мы осуществляем техническую поддержку нашим клиентам и предпродажную проверку качества продукции. На все поставляемые продукты мы предоставляем гарантию .

Осуществляем поставки продукции под контролем ВП МО РФ на предприятия военно-промышленного комплекса России , а также работаем в рамках 275 ФЗ с открытием отдельных счетов в уполномоченном банке. Система менеджмента качества компании соответствует требованиям ГОСТ ISO 9001.

Минимальные сроки поставки, гибкие цены, неограниченный ассортимент и индивидуальный подход к клиентам являются основой для выстраивания долгосрочного и эффективного сотрудничества с предприятиями радиоэлектронной промышленности, предприятиями ВПК и научно-исследовательскими институтами России.

С нами вы становитесь еще успешнее!

Наши контакты:

Телефон: +7 812 627 14 35

Электронная почта: sales@st-electron.ru

Адрес: 198099, Санкт-Петербург,
Промышленная ул, дом № 19, литера Н,
помещение 100-Н Офис 331