

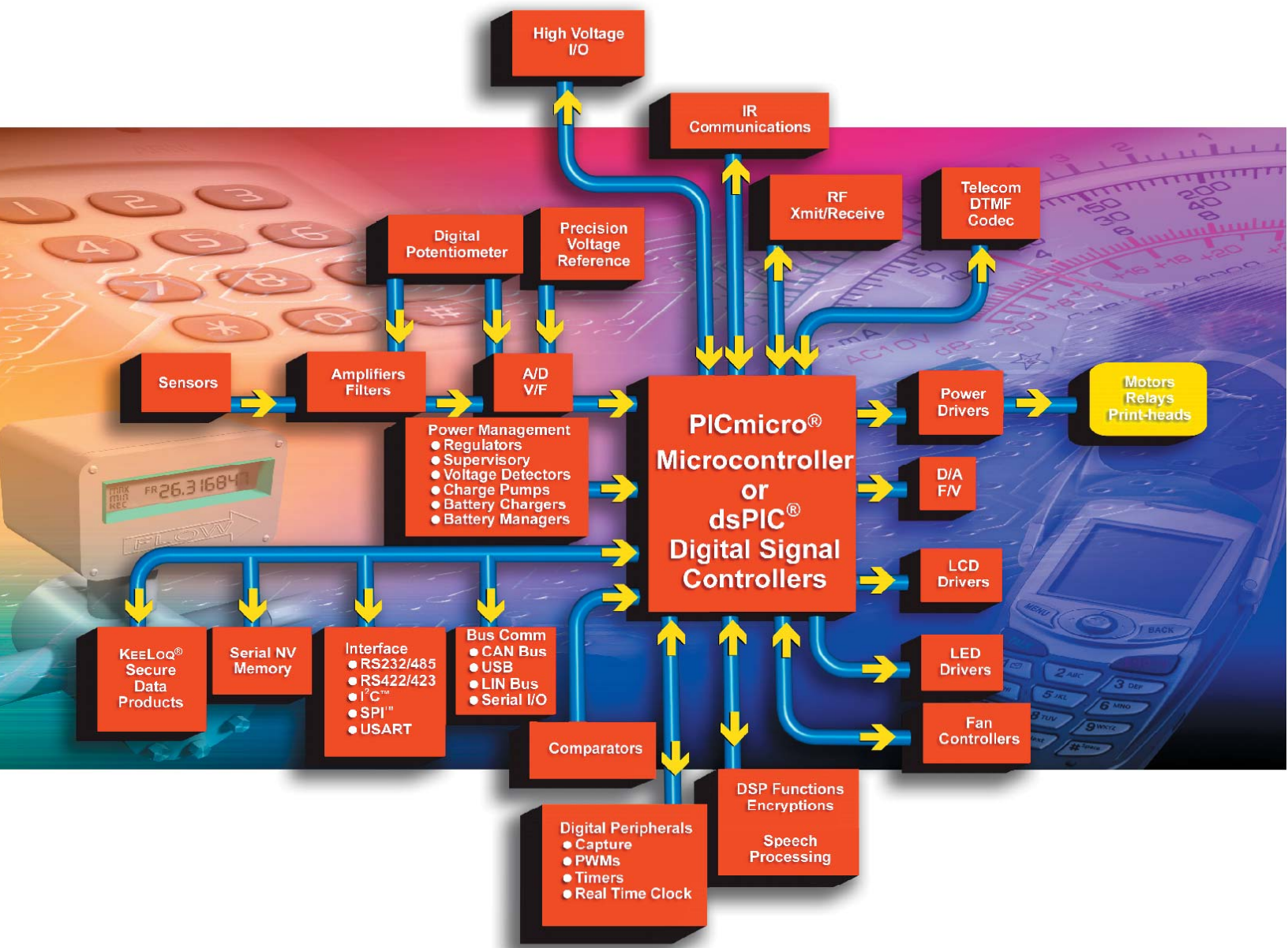

2006 Product Selector Guide



Product Profile

8-bit PIC® Microcontrollers

Microchip's PIC® family of microcontrollers combine high performance, low cost and small package size to offer the best price/performance ratio in the industry. Based on a powerful RISC core, these 8-bit PIC® microcontrollers fall into three product architecture categories, providing a variety of options for any application requirement:

- **Baseline 8-bit architecture:** 12-bit instruction set, 6-44 pin count, 384-3.5K bytes program memory, up to 5 MIPS
- **Mid-Range 8-bit architecture:** 14-bit instruction set, 8-68 pin count, 896-14K bytes program memory, up to 5 MIPS
- **High-Performance (PIC18) 8-bit architecture:** 16-bit instruction set, 18-100 pin count, 8K-128K bytes program memory, up to 16 MIPS

The common architecture provides users with an easy migration path from 6 to 100 pins among all families with little or no code change required. Advanced features available are:

- Sophisticated timing peripherals
- Embedded analog peripherals including A/D and D/A converters, comparators, PBOR, PLVD, DAC, V_{REF}, Op Amps and PSMC
- Communications peripherals (I²C™/SPI™/USB/CAN and USARTs)
- Low-power, single-chip RF solutions targeting RF connectivity for high-volume embedded control applications
- Battery management solutions
- Flexible programming options including In-Circuit Serial Programming™ (ICSP™) technology, self-programming (Enhanced Flash), One-Time-Programmable (OTP), QTP, SQTP and ROM

16-bit PIC® Microcontrollers

The PIC24 microcontrollers build upon the high performance, wide selection of peripherals, Flash memory sizes and packaging choices found in the 8-bit PIC18 family. The PIC24 architecture, paired with the optimized MPLAB C30 C Compiler, provides the high throughput and C code density needed to achieve system performance goals and product launch schedules.

- Leadership 16-bit microcontroller performance and C code efficiency
- Extension of the 8-bit PIC18 microcontroller performance, memory and peripherals
- Easy migration path to dsPIC® digital signal controllers with over 40 MIPS and DSP capability, MPLAB® compatibility

16-bit dsPIC® Digital Signal Controllers (DSC)

Microchip's 16-bit high-performance digital signal controllers combine in a single core the best features of microcontrollers with the best features of DSPs. These dsPIC DSC devices reach speeds of up to 40 MIPS, are very efficient for C programming, and have Flash, data EEPROM, powerful peripherals and a variety of software libraries that allow high performance embedded solutions to be designed effortlessly and rapidly. With a familiar microcontroller "feel", tools and design environment, these dsPIC DSCs target applications, such as motor control and power conversion, speech and audio, internet and modem connectivity, telecom, encryption, high-speed sensing and automotive applications.

Stand-Alone Analog & Interface Products

Microchip offers a broad portfolio of analog and related products:

- **Linear and Mixed-Signal.** ADCs/DACs, digital potentiometers, op amps and comparators.
- **Power Management.** LDO and switching regulators, charge pumps, voltage references, CPU/system supervisors and voltage detectors, battery chargers and power MOSFET drivers.
- **Thermal Management.** Temperature sensors (logic output, voltage output, and serial output), brushless DC fan controllers, and fan fault detectors.
- **Interface.** Peripheral products supporting industry-standard networking protocols like CAN, LIN and infrared (including IrDA® Standard infrared), as well as products that provide embedded system input/output expansion capability.

Secure Data Products

Microchip's KEELoQ® code hopping algorithm combines high security, a small package outline and a very low cost to make this an ideal solution for unidirectional RKE systems. The KEELoQ code hopping technology creates a high degree of security using a long code word length together with encryption and synchronization techniques.

Memory Products

Microchip offers one of the broadest selections of serial EEPROMs in densities from 128 bits to 1 Mbit, with operating voltages down to 1.8V, in all popular bus protocols (I²C™, Microwire and SPI™ compatible). They are available in all standard temperature ranges from -40°C to +125°C and packaged in the world's smallest standard packaging; up to 16 Kbits in 5-lead SOT-23 and up to 256 Kbits in 8-lead MSOP.

Development Systems

Microchip offers a full range of microcontroller development systems, including the MPLAB® ICE 2000 and ICE 4000 in-circuit emulators; MPLAB Integrated Development Environment; MPLAB C18 and C30 Compiler; the MPLAB ICD In-Circuit Debugger, MPLAB PM3 full-featured device programmer; PICSTART® low-cost development system; the PICKIT™ 2 Flash Starter Kit, SEEVAL® Serial EEPROM Evaluation Kit and various demonstration boards. Microchip has shipped more than 300,000+ development systems worldwide.

TABLE OF CONTENTS

CURRENT dsPIC® DIGITAL SIGNAL CONTROLLER FAMILY PRODUCTS	6
dsPIC® Digital Signal Controller (DSC) Family	6
dsPIC30F Motor Control and Power Conversion Family: 30 MIPS, 2.5 - 5.5V V _{DD} , Self-Write Flash	6
dsPIC30F General Purpose Family: 30 MIPS, 2.5 - 5.5V V _{DD} , Self-Write Flash	6
dsPIC30F Sensor Family: 30 MIPS, 2.5 - 5.5V V _{DD} , Self-Write Flash	7
dsPIC33F Motor Control Family: 40 MIPS, V _{DD} = 3.3V, Self-Write Flash	7
dsPIC33F General Purpose Family: 40 MIPS, V _{DD} = 3.3V, Self-Write Flash	8
FUTURE dsPIC® DIGITAL SIGNAL CONTROLLER FAMILY PRODUCTS	9
dsPIC® Digital Signal Controller (DSC) Family	9
dsPIC33F Motor Control Family: 40 MIPS, V _{DD} = 3.3V, Self-Write Flash	9
dsPIC33F General Purpose Family: 40 MIPS, V _{DD} = 3.3V, Self-Write Flash	9
CURRENT ANALOG/INTERFACE PRODUCTS	10
THERMAL MANAGEMENT PRODUCTS – Temperature Sensors	10
Logic Output Temperature Sensors	10
Voltage Output Temperature Sensors	10
Serial Output Temperature Sensors	10
THERMAL MANAGEMENT PRODUCTS – Brushless DC Fan Controllers and Fan Fault Detectors	11
POWER MANAGEMENT – Voltage References	12
POWER MANAGEMENT – Linear Regulators	13
50 mA to 250 mA Low Dropout Linear Regulators	13
300 mA Low Dropout Linear Regulators	14
500 mA to 800 mA Low Dropout Linear Regulators	14
1A and Above Low Dropout Linear Regulators	14
Application Specific Low Dropout Linear Regulators	14
Power Management Combination Products	14
POWER MANAGEMENT – Switching Regulators	15
POWER MANAGEMENT – PWM Controllers	16
POWER MANAGEMENT – Charge Pump DC-to-DC Converters	16
Inverting or Doubling Charge Pumps	16
Multi-Function Charge Pumps	17
Inverting and Doubling Charge Pumps	17
Regulated Charge Pumps	17
POWER MANAGEMENT – CPU/System Supervisors	17
POWER MANAGEMENT – Voltage Detectors	18
POWER MANAGEMENT – Power MOSFET Drivers	19
Low-Side Drivers, 0.5A to 1.2A Peak Output Current	19
Low-Side Drivers, 1.5A Peak Output Current	19
Low-Side Drivers, 2.0A to 12.0A Peak Output Current	20
High-Side/Low-Side Drivers	20

POWER MANAGEMENT – Battery Chargers	20
POWER MANAGEMENT – Hot Swap Controllers	21
LINEAR – Op Amps	21
LINEAR – High Precision Operational Amplifiers	24
Chopper Stabilized	24
Auto-Zero	24
LINEAR – Programmable Gain Amplifiers (PGA)	24
LINEAR – Integrated Devices	24
LINEAR – Comparators	24
MIXED SIGNAL – Successive Approximation Register (SAR) A/D Converters	25
MIXED SIGNAL – Delta-Sigma A/D Converters	25
MIXED SIGNAL – Energy Measurement ICs	26
MIXED SIGNAL – Dual Slope A/D Converters	26
MIXED SIGNAL – Binary and BCD A/D Converters	27
MIXED SIGNAL – Display A/D Converters	27
MIXED SIGNAL – Digital Potentiometers	28
MIXED SIGNAL – Frequency-to-Voltage/Voltage-to-Frequency Converters	28
MIXED SIGNAL – D/A Converters	28
INTERFACE – Controller Area Network (CAN) Products	29
INTERFACE – Infrared Products	29
INTERFACE – Ethernet Products	30
INTERFACE – LIN Transceiver Products	30
INTERFACE – Serial Peripherals	30
INTERFACE – Passive Access Products	30
FUTURE ANALOG/INTERFACE PRODUCTS	31
POWER MANAGEMENT – Low-Side Power MOSFET Drivers	31
POWER MANAGEMENT – Battery Chargers	31
POWER MANAGEMENT – Linear Regulators	31
POWER MANAGEMENT – Switching Regulators	31
LINEAR – Linear Gain Blocks	31
MIXED SIGNAL – Delta-Sigma A/D Converters	32
CURRENT PICMICRO® MICROCONTROLLER FAMILY PRODUCTS	33
Baseline 8-Bit PICmicro® Microcontroller Family (12-bit Instruction Set)	33
PIC10FXXX	33
PIC12FXXX	33
PIC16F5XX	33
PIC16C5X	33
Mid-Range 8-Bit PICmicro® Microcontroller Family (14-bit Instruction Set)	34
PIC12FXXX	34
PIC16FXXX	34
PIC16CXXX	36

High-Performance 8-Bit PICmicro® Microcontroller Family (16-bit Instruction Set)	37
PIC18 Flash MCUs	37
PIC18FXXJXX Flash MCUs	41
PIC24 16-Bit Microcontroller (MCU) Family	43
PIC24FJ Family 16-bit Flash MCUs	43
PIC24HJ Family 16-bit Flash MCUs	43
FUTURE PICMICRO® MICROCONTROLLER FAMILY PRODUCTS	44
Mid-Range 8-Bit PICmicro® Microcontroller Family (14-bit Instruction Set)	44
PIC12FXXX	44
PIC16FXXX	44
PIC16CRXX	45
PIC18FXXX	45
PIC18FXXJXX	45
PIC18FXXKXX Flash MCUs: 16 MIPS, Vdd = 1.8 - 3.6V, Self-Write	47
PIC24 16-Bit Microcontroller (MCU) Family	47
PIC24FJ Family 16-bit Flash MCUs	47
PIC24HJ Family 16-bit Flash MCUs	48
MATURE – PICMICRO® MICROCONTROLLER FAMILY PRODUCTS	49
FOCUSED SOLUTIONS	51
CAN Solutions	51
CAN Peripherals/Transceivers	53
Ethernet Solutions – Integrated	54
Ethernet Solutions – Stand-Alone	54
USB Solutions	54
USB Battery Chargers	55
Switching Battery Chargers	56
Battery Fuel Gauge ICs	56
Radio Frequency Solutions	56
rfPIC® Microcontrollers with UHF RF Transmitter, ICSP™	56
rfHCS KEELOQ® Encoders with UHF RF Transmitter	56
UHF RF Receiver	57
microID® RFID Tagging Devices	57
LCD Solutions	57
Display Solutions	58
Motor Control Solutions	59
Motor Control Solutions - MOSFET Drivers	61
Motor Control Solutions - LINEAR – Comparators	61
Motor Control Solutions - LINEAR – Op Amps	62
Motor Control Solutions - LINEAR – High Precision Operational Amplifiers	64
High-Speed Sensing Solutions	64
Power-Managed Solutions Featuring nanoWatt Technology	65

CURRENT SECURE DATA PRODUCTS	66
KEELOQ® Encoder Devices	66
KEELOQ® Decoder Devices	66
KEELOQ® Programmable Encoder/Decoder Flash Devices (x14), ICSP™	66
CURRENT SERIAL ELECTRICALLY ERASABLE PROMS (EEPROM)	67
Microwire Compatible Serial EEPROM Family	67
2-Wire I ² C™ Compatible Serial EEPROM Family	68
ISO Smart Card Family	69
SPI™ Compatible Serial EEPROM Family	69
Identification Products	70
FUTURE SERIAL ELECTRICALLY ERASABLE PROMS (EEPROM)	71
SPI™ Compatible Serial EEPROM Family – Page Write mode, HOLD pin, software enabled block write protection and hardware write-protect pin	71
DEVELOPMENT SYSTEMS	72
MPLAB® ICE 2000 and MPLAB® ICE 4000 Emulator Systems	72
How Do I Order MPLAB® ICE?	72
A Complete MPLAB® ICE System	72
MPLAB® PM3 Programmers	72
In-Circuit Debuggers: MPLAB® ICD 2	72
MPLAB® ICE 2000 and MPLAB® ICE 4000 Emulator Systems, PRO MATE® II Programmer Socket Modules, MPLAB® In-Circuit Debugger, Software Tools, Programmers and Demonstration Boards	73
Analog Interface Development Tools	73
PICmicro® Microcontroller Development Tools	73
rPIC® Microcontroller Development Tools	103
dsPIC® DSC Development Tools	104
Notes	107
Demonstration Boards and Evaluation Kits	108
PICmicro® Demonstration Kits	108
Connectivity Demonstration Kits	108
Mixed Signal Control Demonstration Kits	109
dsPIC® Digital Signal Controller Demonstration Kits	109
dsPIC® 16-bit DSC Software Tools	109
PowerSmart® Systems	110
Memory Evaluation/Developer's Kits	110
KEELOQ® Evaluation Kits	111
RFID Evaluation/Developer's Kits	111
Analog/Interface Demo/Eval/Developer's Kits	111

PIN AND CODE COMPATIBILITY CHARTS 113

PACKAGE PHOTOS 118

PART NUMBER SUFFIX DESIGNATIONS 121

 Ordering Information for all Microchip PICmicro®, KeeLoq®, RFID, rHCS and Memory Products .121

 Ordering Information for all Microchip Analog Products beginning with “TC” (formerly TelCom
 Semiconductor Products)122

 Ordering Information for all Microchip Analog Products beginning with “MCP” Prefix Parts123

ABBREVIATIONS. 124

CURRENT dsPIC® DIGITAL SIGNAL CONTROLLER FAMILY PRODUCTS

dsPIC® Digital Signal Controller (DSC) Family																			
Product	Program (Flash) KBytes	Memory (Flash) KWords	EE Bytes	SRAM Bytes	I/O Pins (max.)	Packages	A/D 12-bit 200 ksps	A/D 10-bit 1000 ksps	Timer 16-bit	Input Cap	Output Comp/Std PWM	Motor Control PWM	Quad Enc.	UART	SPI™	I ² C™	CAN	Codec Interface	
dsPIC30F Motor Control and Power Conversion Family: 30 MIPS, 2.5 - 5.5V V_{DD}, Self-Write Flash																			
NEW	dsPIC30F2005*	8	2.66	—	384	20	28SO, 28SP, 28MM (6x6)	—	6 ch	3	3	1	6	✓	1	0	0	—	—
	dsPIC30F2010	12	4	1024	512	20	28SO, 28SP, 28MM (6x6)	—	6 ch	3	4	2	6	✓	1	1	1	—	—
NEW	dsPIC30F2015*	12	4	1024	512	20	28SO, 28SP, 28MM (6x6)	—	6 ch	3	4	2	6	✓	1	1	1	—	—
	dsPIC30F3010	24	8	1024	1024	20	28SO, 28SP, 44ML (8x8)	—	6 ch	5	4	2	6	✓	1	1	1	—	—
	dsPIC30F4012	48	16	1024	2048	20	28SO, 28SP, 44ML (8x8)	—	6 ch	5	4	2	6	✓	1	1	1	1	—
	dsPIC30F3011	24	8	1024	1024	30	40P, 44PT, 44ML (8x8)	—	9 ch	5	4	4	6	✓	2	1	1	—	—
	dsPIC30F4011	48	16	1024	2048	30	40P, 44PT, 44ML (8x8)	—	9 ch	5	4	4	6	✓	2	1	1	1	—
	dsPIC30F5015	66	22	1024	2048	52	64PT	—	16 ch	5	4	4	8	✓	1	2	1	1	—
	dsPIC30F6015	144	48	4096	8192	52	64PT	—	16 ch	5	8	8	8	✓	2	2	1	2	—
	dsPIC30F5016	66	22	1024	2048	68	80PT	—	16 ch	5	4	4	8	✓	1	2	1	1	—
	dsPIC30F6010	144	48	4096	8192	68	80PF	—	16 ch	5	8	8	8	✓	2	2	1	2	—
NEW	dsPIC30F6010A	144	48	4096	8192	68	80PF, 80PT	—	16 ch	5	8	8	8	✓	2	2	1	2	—
dsPIC30F General Purpose Family: 30 MIPS, 2.5 - 5.5V V_{DD}, Self-Write Flash																			
	dsPIC30F3014	24	8	1024	2048	30	40P, 44PT, 44ML (8x8)	13 ch	—	3	2	2	—	—	2	1	1	—	—
	dsPIC30F4013	48	16	1024	2048	30	40P, 44PT, 44ML (8x8)	13 ch	—	5	4	4	—	—	2	1	1	1	AC97, I ² S
	dsPIC30F5011	66	22	1024	4096	52	64PT	16 ch	—	5	8	8	—	—	2	2	1	2	AC97, I ² S
	dsPIC30F6011	132	44	2048	6144	52	64PF	16 ch	—	5	8	8	—	—	2	2	1	2	—
NEW	dsPIC30F6011A	132	44	2048	6144	52	64PF, 64PT	16 ch	—	5	8	8	—	—	2	2	1	2	—
NEW	dsPIC30F6012	144	48	4096	8192	52	64PF	16 ch	—	5	8	8	—	—	2	2	1	2	AC97, I ² S

* Contact Microchip Technology for availability date.
Abbreviations are found on the last page of the Selector Guide.

dsPIC® Digital Signal Controller (DSC) Family (continued)

Product	Program (Flash) KBytes	Memory (Flash) KWords	EE Bytes	SRAM Bytes	I/O Pins (max.)	Packages	A/D 12-bit 200 ksps	A/D 10-bit 1000 ksps	Timer 16-bit	Input Cap	Output Comp/Std PWM	Motor Control PWM	Quad Enc.	UART	SPI™	I ² C™	CAN	Codec Interface	
dsPIC30F6012A	144	48	4096	8192	52	64PF, 64PT	16 ch	—	5	8	8	—	—	2	2	1	2	AC97, I ² S	
dsPIC30F General Purpose Family: 30 MIPS, 2.5 - 5.5V V_{DD}, Self-Write Flash (continued)																			
dsPIC30F5013	66	22	1024	4096	68	80PT	16 ch	—	5	8	8	—	—	2	2	1	2	AC97, I ² S	
NEW	dsPIC30F6013	132	44	2048	6144	68	80PF	16 ch	—	5	8	8	—	—	2	2	1	2	—
	dsPIC30F6013A	132	44	2048	6144	68	80PF, 80PT	16 ch	—	5	8	8	—	—	2	2	1	2	—
NEW	dsPIC30F6014	144	48	4096	8192	68	80PF	16 ch	—	5	8	8	—	—	2	2	1	2	AC97, I ² S
	dsPIC30F6014A	144	48	4096	8192	68	80PF, 80PT	16 ch	—	5	8	8	—	—	2	2	1	2	AC97, I ² S
dsPIC30F Sensor Family: 30 MIPS, 2.5 - 5.5V V_{DD}, Self-Write Flash																			
dsPIC30F2011	12	4	0	1024	12	18SO, 18P, 28ML (6x6)	8 ch	—	3	2	2	—	—	1	1	1	—	—	
dsPIC30F3012	24	8	1024	2048	12	18SO, 18P, 28ML (6x6)	8 ch	—	3	2	2	—	—	1	1	1	—	—	
dsPIC30F2012	12	4	0	1024	20	28SO, 28SP, 28ML (6x6)	10 ch	—	3	2	2	—	—	1	1	1	—	—	
dsPIC30F3013	24	8	1024	2048	20	28SO, 28SP, 28ML (6x6)	10 ch	—	3	2	2	—	—	2	1	1	—	—	

* Contact Microchip Technology for availability date.
Abbreviations are found on the last page of the Selector Guide.

Product	Program (Flash) Kbytes	SRAM KBytes	DMA	I/O Pins (max.)	Packages	A/D 12-bit 500 ksps	A/D 10-bit 1,000 ksps	Timer 16-bit	Input Cap	Output Comp/Std PWM	Motor Control PWM	Quad Enc. Interface	UART	SPI™	I ² C™	CAN	Codec Interface	
dsPIC33F Motor Control Family: 40 MIPS, V_{DD} = 3.3V, Self-Write Flash																		
NEW	dsPIC33FJ64MC508*	64	8	6 ch	69	80PT	—	1 A/D, 18 ch 4 S/H	9	8	8	8	✓	2	2	2	1	—
NEW	dsPIC33FJ64MC706*	64	16	6 ch	53	64PT	—	2 A/D, 16 ch 8 S/H	9	8	8	8	✓	2	2	2	1	—
NEW	dsPIC33FJ64MC710*	64	16	6 ch	85	100PT	—	2 A/D, 24 ch 8 S/H	9	8	8	8	✓	2	2	2	2	—
NEW	dsPIC33FJ128MC706*	128	16	6 ch	53	64PT	—	2 A/D, 16 ch 8 S/H	9	8	8	8	✓	2	2	2	1	—

NOTE: dsPIC33 devices with 2 ADCs can achieve 2.2 Msps conversion rate.
*Contact Microchip Technology for availability date.
Abbreviations are found on the last page of the Selector Guide.

	Product	Program (Flash) Kbytes	SRAM KBytes	DMA	I/O Pins (max.)	Packages	A/D 12-bit 500 ksps	A/D 10-bit 1,000 ksps	Timer 16-bit	Input Cap	Output Comp/Std PWM	Motor Control PWM	Quad Enc. Interface	UART	SPI™	I ² C™	CAN	Codec Interface	
dsPIC33F Motor Control Family: 40 MIPS, V_{DD} = 3.3V, Self-Write Flash (continued)																			
NEW	dsPIC33FJ128MC708*	128	16	6 ch	69	80PT	—	2 A/D, 18 ch 8 S/H	9	8	8	8	✓	2	2	2	2	—	
NEW	dsPIC33FJ256MC710*	256	30	6 ch	85	100PT	—	2 A/D, 24 ch 8 S/H	9	8	8	8	✓	2	2	2	2	—	
dsPIC33F General Purpose Family: 40 MIPS, V_{DD} = 3.3V, Self-Write Flash																			
NEW	dsPIC33FJ64GP706*	64	16	6 ch	53	64PT	2 ADC, 18 ch 2 S/H	—	9	8	8	—	—	2	2	2	2	1	
NEW	dsPIC33FJ64GP708*	64	16	6 ch	69	80PT	2 ADC, 24 ch 2 S/H	—	9	8	8	—	—	2	2	2	2	1	
NEW	dsPIC33FJ64GP710*	64	16	6 ch	85	100PT	2 ADC, 32 ch 2 S/H	—	9	8	8	—	—	2	2	2	2	1	
NEW	dsPIC33FJ128GP708*	128	16	6 ch	69	80PT	2 ADC, 24 ch 2 S/H	—	9	8	8	—	—	2	2	2	2	1	
NEW	dsPIC33FJ256GP506*	256	16	6 ch	53	64PT	1 ADC, 18 ch	—	9	8	8	—	—	2	2	2	1	1	
NEW	dsPIC33FJ256GP710*	256	30	6 ch	85	100PT	2 ADC, 32 ch 2 S/H	—	9	8	8	—	—	2	2	2	2	1	

NOTE: dsPIC33 devices with 2 ADCs can achieve 2.2 Msps conversion rate.

*Contact Microchip Technology for availability date.

Abbreviations are found on the last page of the Selector Guide.

FUTURE dsPIC® DIGITAL SIGNAL CONTROLLER FAMILY PRODUCTS

dsPIC® Digital Signal Controller (DSC) Family																	
Product	Program (Flash) Kbytes	SRAM KBytes	DMA	I/O Pins (max.)	Packages	A/D 12-bit 500 kbps	A/D 10-bit 1,000 kbps	Timer 16-bit	Input Cap	Output Comp/Std PWM	Motor Control PWM	Quad Enc. Interface	UART	SPI™	I ² C™	CAN	Codec Interface
dsPIC33F Motor Control Family: 40 MIPS, V_{DD} = 3.3V, Self-Write Flash																	
dsPIC33FJ64MC506	64	8	6 ch	53	64PT	—	1 A/D, 16 ch 4 S/H	9	8	8	8	✓	2	2	2	1	—
dsPIC33FJ64MC510	64	8	6 ch	85	100PT	—	1 A/D, 24 ch 4 S/H	9	8	8	8	✓	2	2	2	1	—
dsPIC33FJ128MC506	128	8	6 ch	53	64PT	—	1 A/D, 16 ch 4 S/H	9	8	8	8	✓	2	2	2	1	—
dsPIC33FJ128MC510	128	8	6 ch	85	100PT	—	1 A/D, 24 ch 4 S/H	9	8	8	8	✓	2	2	2	1	—
dsPIC33FJ128MC710	128	16	6 ch	85	100PT	—	2 A/D, 24 ch 8 S/H	9	8	8	8	✓	2	2	2	2	—
dsPIC33FJ256MC510	256	16	6 ch	85	100PT	—	1 A/D, 16 ch 4 S/H	9	8	8	8	✓	2	2	2	1	—
dsPIC33F General Purpose Family: 40 MIPS, V_{DD} = 3.3V, Self-Write Flash																	
dsPIC33FJ64GP206	64	8	6 ch	53	64PT	1 ADC, 18 ch	—	9	8	8	—	—	2	2	1	0	1
dsPIC33FJ64GP306	64	16	6 ch	53	64PT	1 ADC, 18 ch	—	9	8	8	—	—	2	2	2	0	1
dsPIC33FJ64GP310	64	16	6 ch	85	100PT	1 ADC, 32 ch	—	9	8	8	—	—	2	2	2	0	1
dsPIC33FJ128GP206	128	8	6 ch	53	64PT	1 ADC, 18 ch	—	9	8	8	—	—	2	2	1	0	1
dsPIC33FJ128GP306	128	16	6 ch	53	64PT	1 ADC, 18 ch	—	9	8	8	—	—	2	2	2	0	1
dsPIC33FJ128GP310	128	16	6 ch	85	100PT	1 ADC, 32 ch	—	9	8	8	—	—	2	2	2	0	1
dsPIC33FJ128GP706	128	16	6 ch	53	64PT	2 ADC, 18 ch 2 S/H	—	9	8	8	—	—	2	2	2	2	1
dsPIC33FJ128GP710	128	16	6 ch	85	100PT	2 ADC, 32 ch 2 S/H	—	9	8	8	—	—	2	2	2	2	1
dsPIC33FJ256GP510	256	16	6 ch	85	100PT	1 ADC, 32 ch	—	9	8	8	—	—	2	2	2	1	1

NOTE: dsPIC33 devices with 2 ADCs can achieve 2.2 Msps conversion rate.
Abbreviations are found on the last page of the Selector Guide.

CURRENT ANALOG/INTERFACE PRODUCTS

Lead-free versions of many devices are currently offered. Check Microchip's web site for availability.

THERMAL MANAGEMENT PRODUCTS – Temperature Sensors							
Part #	Typical Accuracy (°C)	Maximum Accuracy @ 25°C (°C)	Maximum Temperature Range (°C)	Vcc Range (V)	Maximum Supply Current (µA)	Features	Packages
Logic Output Temperature Sensors							
TC6501	±0.5	±3	-55 to +125	+2.7 to +5.5	40	Cross to MAX6501, Open-drain	5-Pin SOT-23A
TC6502	±0.5	±3	-55 to +125	+2.7 to +5.5	40	Cross to MAX6502, Push-pull	5-Pin SOT-23A
TC6503	±0.5	±3	-55 to +125	+2.7 to +5.5	40	Cross to MAX6503, Open-drain	5-Pin SOT-23A
TC6504	±0.5	±3	-55 to +125	+2.7 to +5.5	40	Cross to MAX6504, Push-pull	5-Pin SOT-23A
TC620	±1	±3	-40 to +125	+4.5 to +18	400	Two resistor-programmable trip points	8-Pin PDIP, 8-Pin SOIC
TC621	Note 1	Note 1	-40 to +85	+4.5 to +18	400	Requires external thermistor, resistor-programmable trip points	8-Pin PDIP, 8-Pin SOIC
TC622	±1	±5	-40 to +125	+4.5 to +18	600	Dual output, TO-220 for heat sink mounting, resistor-programmable trip points	8-Pin PDIP, 8-Pin SOIC, 5-Pin TO-220
TC623	±1	±3	-40 to +125	+2.7 to +4.5	250	Two resistor-programmable trip points	8-Pin PDIP, 8-Pin SOIC
TC624	±1	±5	-40 to +125	+2.7 to +4.5	300	Dual output, resistor-programmable trip points	8-Pin PDIP, 8-Pin SOIC
Voltage Output Temperature Sensors							
MCP9700	±1	±4	-40 to +125	+2.3 to +5.5	12	Linear Active Thermistor™ IC, Temperature slope: 10 mV/°C	5-pin SC-70
MCP9701	±1	±4	-10 to +125	+3.1 to +5.5	12	Linear Active Thermistor™ IC, Temperature slope: 19.53 mV/°C, cross to MAX6612	5-pin SC-70
TC1046	±0.5	±2	-40 to +125	+2.7 to +4.4	60	High precision temperature-to-voltage converter, 6.25 mV/°C	3-Pin SOT-23B
TC1047	±0.5	±2	-40 to +125	+2.7 to +4.4	60	High precision temperature-to-voltage converter, 10 mV/°C	3-Pin SOT-23B
TC1047A	±0.5	±2	-40 to +125	+2.5 to +5.5	60	High precision temperature-to-voltage converter, 10 mV/°C	3-Pin SOT-23B
Serial Output Temperature Sensors							
MCP9800	±0.5	±1	-55 to +125	+2.7 to +5.5	400	SMBus/I ² C™ compatible interface, 0.0625°C to 0.5°C adj. resolution, power-saving one-shot temperature measurement	5-Pin SOT-23
MCP9801	±0.5	±1	-55 to +125	+2.7 to +5.5	400	SMBus/I ² C™ compatible interface, 0.0625°C to 0.5°C adj. resolution, power-saving one-shot temperature measurement, multi-drop capability	8-Pin MSOP, 8-pin SOIC
MCP9802	±0.5	±1	-55 to +125	+2.7 to +5.5	400	SMBus/I ² C™ compatible interface with time out, 0.0625°C to 0.5°C adj. resolution, power-saving one-shot temperature measurement	5-Pin SOT-23

NOTE 1: These devices use an external temperature sensor. Accuracy of the total solution is a function of the accuracy of the external sensor.
NOTE 2: TCN75 idle current is 250 µA. This device also has a Software Shutdown mode that reduces supply current to <1 µA.
NOTE 3: MCP9805 max. accuracy measured at 85°C.

THERMAL MANAGEMENT PRODUCTS – Temperature Sensors (continued)

Part #	Typical Accuracy (°C)	Maximum Accuracy @ 25°C (°C)	Maximum Temperature Range (°C)	Vcc Range (V)	Maximum Supply Current (µA)	Features	Packages
Serial Output Temperature Sensors (continued)							
MCP9803	±0.5	±1	-55 to +125	+2.7 to +5.5	400	SMBus/I ² C™ compatible interface with time out, 0.0625°C to 0.5°C adj. resolution, power-saving one-shot temperature measurement, multi-drop capability	8-Pin MSOP, 8-Pin SOIC
MCP9805	±0.5	±1 ⁽³⁾	-20 to +125	+3.0 to +3.6	400	JEDEC compatible register set, SMBus/I ² C™ compatible interface, programmable, shutdown modes and EVENT output	8-Pin TSSOP, 8-Pin 2x3 DFN
TC77	±0.5	±1	-55 to +125	+2.7 to +5.5	400	SPI™ compatible interface, 0.0625°C temperature resolution	5-Pin SOT-23A, 8-Pin SOIC
TC72	±0.5	±1	-55 to +125	+2.65 to +5.5	400	SPI™ compatible interface, power saving one-shot temperature measurement, 0.25°C temperature resolution	8-Pin MSOP, 8-Pin 3x3 DFN
TC74	±0.5	±2	-40 to +125	+2.7 to +5.5	350	SMBus/I ² C™ compatible interface, 1°C temperature resolution	5-Pin SOT-23A, 5-Pin TO-220
TCN75A	±0.5	±2	-40 to +125	+2.7 to +5.5	500	SMBus/I ² C™ compatible interface, power-saving one-shot temperature measurement, multi-drop capability, 0.0625°C to 0.5°C adjustable temperature resolution	8-Pin SOIC, 8-Pin MSOP
TCN75	±0.5	±2	-55 to +125	+2.7 to +5.5	1,000 ⁽²⁾	SMBus/I ² C™ compatible interface, multi-drop capability, interrupt output, 0.5°C temperature resolution	8-Pin MSOP, 8-Pin SOIC

NOTE 1: These devices use an external temperature sensor. Accuracy of the total solution is a function of the accuracy of the external sensor.
NOTE 2: TCN75 idle current is 250 µA. This device also has a Software Shutdown mode that reduces supply current to <1 µA.
NOTE 3: MCP9805 max. accuracy measured at 85°C.

THERMAL MANAGEMENT PRODUCTS – Brushless DC Fan Controllers and Fan Fault Detectors

Part #	Description	Typical Accuracy (°C)	Maximum Accuracy @ 25°C (°C)	Maximum Temperature Range (°C)	Vcc Range (V)	Maximum Supply Current (µA)	Features	Packages
TC642	Fan Manager	Note 1	Note 1	-40 to +85	+3.0 to +5.5	1,000	FanSense™ Fan Monitor, minimum fan speed control	8-Pin PDIP, 8-Pin SOIC, 8-Pin MSOP
TC642B	Fan Manager	Note 1	Note 1	-40 to +85	+3.0 to +5.5	400	FanSense™ Fan Monitor, minimum fan speed control, fan auto-restart	8-Pin PDIP, 8-Pin SOIC, 8-Pin MSOP
TC646	Fan Manager	Note 1	Note 1	-40 to +85	+3.0 to +5.5	1,000	FanSense™ Fan Monitor, auto-shutdown	8-Pin PDIP, 8-Pin SOIC, 8-Pin MSOP
TC646B	Fan Manager	Note 1	Note 1	-40 to +85	+3.0 to +5.5	400	FanSense™ Fan Monitor, auto-shutdown, fan auto-restart	8-Pin PDIP, 8-Pin SOIC, 8-Pin MSOP
TC647	Fan Manager	Note 1	Note 1	-40 to +85	+3.0 to +5.5	1,000	FanSense™ Fan Monitor, minimum fan speed control	8-Pin PDIP, 8-Pin SOIC, 8-Pin MSOP

NOTE 1: These devices use an external temperature sensor. Accuracy of the total solution is a function of the accuracy of the external sensor.

THERMAL MANAGEMENT PRODUCTS – Brushless DC Fan Controllers and Fan Fault Detectors (continued)

Part #	Description	Typical Accuracy (°C)	Maximum Accuracy @ 25°C (°C)	Maximum Temperature Range (°C)	Vcc Range (V)	Maximum Supply Current (µA)	Features	Packages
TC647B	Fan Manager	Note 1	Note 1	-40 to +85	+3.0 to +5.5	400	FanSense™ Fan Monitor, minimum fan speed control, fan auto-restart	8-Pin PDIP, 8-Pin SOIC, 8-Pin MSOP
TC648	Fan Manager	Note 1	Note 1	-40 to +85	+3.0 to +5.5	1,000	Over-temperature alert, auto-shutdown	8-Pin PDIP, 8-Pin SOIC, 8-Pin MSOP
TC648B	Fan Manager	Note 1	Note 1	-40 to +85	+3.0 to +5.5	400	Over-temperature alert, auto-shutdown, fan auto-restart	8-Pin PDIP, 8-Pin SOIC, 8-Pin MSOP
TC649	Fan Manager	Note 1	Note 1	-40 to +85	+3.0 to +5.5	1,000	FanSense™ Fan Monitor, auto-shutdown	8-Pin PDIP, 8-Pin SOIC, 8-Pin MSOP
TC649B	Fan Manager	Note 1	Note 1	-40 to +85	+3.0 to +5.5	400	FanSense™ Fan Monitor, auto-shutdown, fan auto-restart	8-Pin PDIP, 8-Pin SOIC, 8-Pin MSOP
TC650	Fan Manager	±1	±3	-40 to +125	+2.8 to +5.5	90	Over-temperature alert	8-Pin MSOP
TC651	Fan Manager	±1	±3	-40 to +125	+2.8 to +5.5	90	Over-temperature alert, auto-shutdown	8-Pin MSOP
TC652	Fan Manager	±1	±3	-40 to +125	+2.8 to +5.5	90	FanSense™ Fan Monitor, over-temperature alert	8-Pin MSOP
TC653	Fan Manager	±1	±3	-40 to +125	+2.8 to +5.5	90	FanSense™ Fan Monitor, over-temperature alert, auto-shutdown	8-Pin MSOP
TC654	Dual SMBus Fan Manager	Note 1	Note 1	-40 to +85	+3.0 to +5.5	320	FanSense™ Fan Monitor, RPM data	10-Pin MSOP
TC655	Dual SMBus Fan Manager	Note 1	Note 1	-40 to +85	+3.0 to +5.5	320	FanSense™ Fan Monitor, RPM data, over-temperature alert	10-Pin MSOP
TC664	Single SMBus Fan Manager	Note 1	Note 1	-40 to +85	+3.0 to +5.5	320	FanSense™ Fan Monitor, RPM data	10-Pin MSOP
TC665	Single SMBus Fan Manager	Note 1	Note 1	-40 to +85	+3.0 to +5.5	320	FanSense™ Fan Monitor, RPM data, over-temperature alert	10-Pin MSOP
TC670	Predictive Fan Fault Detector	N/A	N/A	-40 to +85	+3.0 to +5.5	150	FanSense™ Fan Monitor, programmable threshold	6-Pin SOT-23

NOTE 1: These devices use an external temperature sensor. Accuracy of the total solution is a function of the accuracy of the external sensor.

POWER MANAGEMENT – Voltage References

Part #	Vcc Range (V)	Output Voltage (V)	Max. Load Current (mA)	Initial Accuracy (max.%)	Temperature Coefficient (ppm/°C)	Max. Supply Current (µA @ 25°C)	Packages
MCP1525	2.7 to 5.5	2.5	±2	±1	50	100	3-Pin TO-92, 3-Pin SOT-23B
MCP1541	4.3 to 5.5	4.096	±2	±1	50	100	3-Pin TO-92, 3-Pin SOT-23B

POWER MANAGEMENT – Linear Regulators

Part #	Max. Input Voltage (V)	Output Voltage (V)	Output Current (mA)	Junction Temperature Range (°C)	Typical Active Current (µA)	Typical Dropout Voltage @ Max. I _{OUT} (mV)	Typical Output Voltage Accuracy (%)	Features	Packages
50 mA to 250 mA Low Dropout Linear Regulators									
TC2014	6.0	1.8, 2.7, 2.8, 3.0, 3.3	50	-40 to +125	55	45	±0.4	Shutdown, Reference bypass input	5-Pin SOT-23A
TC1014	6.0	1.8, 2.5, 2.7, 2.8, 2.85, 3.0, 3.3, 3.6, 4.0, 5.0	50	-40 to +125	50	85	±0.5	Shutdown, Reference bypass input	5-Pin SOT-23A
TC2054	6.0	1.8, 2.7, 2.8, 3.0, 3.3	50	-40 to +125	55	45	±0.4	Shutdown, Error output	5-Pin SOT-23A
TC1054	6.0	1.8, 2.5, 2.7, 2.8, 2.85, 3.0, 3.3, 3.6, 4.0, 5.0	50	-40 to +125	50	85	±0.5	Shutdown, Error output	5-Pin SOT-23A
TC1070	6.0	1.23 → V _{IN}	50	-40 to +125	50	85	—	Shutdown, Adjustable	5-Pin SOT-23A
TC1072	6.0	2.5, 2.7, 2.8, 2.85, 3.0, 3.3, 3.6, 4.0, 5.0	50	-40 to +125	50	85	±0.5	Shutdown, Reference bypass input, Error output	6-Pin SOT-23A
TC1223	6.0	2.5, 2.7, 2.8, 3.0, 3.3, 3.6, 4.0, 5.0	50	-40 to +125	50	85	±0.5	Shutdown	5-Pin SOT-23A
TC1016	6.0	1.8, 2.7, 2.8, 3.0	80	-40 to +125	50	150	±0.5	Shutdown	5-Pin SC-70
TC2015	6.0	1.8, 2.7, 2.8, 3.0, 3.3	100	-40 to +125	55	90	±0.4	Shutdown, Reference bypass input	5-Pin SOT-23A
TC1015	6.0	1.8, 2.5, 2.7, 2.8, 2.85, 3.0, 3.3, 3.6, 4.0, 5.0	100	-40 to +125	50	180	±0.5	Shutdown, Reference bypass input	5-Pin SOT-23A
TC2055	6.0	1.8, 2.7, 2.8, 3.0, 3.3	100	-40 to +125	55	90	±0.4	Shutdown, Error output	5-Pin SOT-23A
TC1055	6.0	1.8, 2.5, 2.7, 2.8, 2.85, 3.0, 3.3, 3.6, 4.0, 5.0	100	-40 to +125	50	180	±0.5	Shutdown, Error output	5-Pin SOT-23A
TC1071	6.0	1.23 → V _{IN}	100	-40 to +125	50	180	—	Shutdown, Adjustable	5-Pin SOT-23A
TC1073	6.0	2.5, 2.7, 2.8, 2.85, 3.0, 3.3, 3.6, 4.0, 5.0	100	-40 to +125	50	180	±0.5	Shutdown, Reference bypass input, Error output	6-Pin SOT-23A
TC1224	6.0	2.5, 2.7, 2.8, 3.0, 3.3, 3.6, 4.0, 5.0	100	-40 to +125	50	180	±0.5	Shutdown	5-Pin SOT-23A
TC1188	6.0	1.8, 2.8, 2.84, 3.15	120	-40 to +125	50	130	±0.5	Shutdown	5-Pin SOT-23A
TC1189	6.0	1.8, 2.8, 2.84, 3.15	120	-40 to +125	50	130	±0.5	Shutdown	5-Pin SOT-23A
TC2185	6.0	1.8, 2.7, 2.8, 3.0, 3.3	150	-40 to +125	55	140	±0.4	Shutdown, Reference bypass input	5-Pin SOT-23A
TC1185	6.0	1.8, 2.5, 2.7, 2.8, 2.85, 3.0, 3.3, 3.6, 4.0, 5.0	150	-40 to +125	50	270	±0.5	Shutdown, Reference bypass input	5-Pin SOT-23A
TC2186	6.0	1.8, 2.7, 2.8, 3.0, 3.3	150	-40 to +125	55	140	±0.4	Shutdown, Error output	5-Pin SOT-23A
TC1186	6.0	1.8, 2.5, 2.7, 2.8, 2.85, 3.0, 3.3, 3.6, 4.0, 5.0	150	-40 to +125	50	270	±0.5	Shutdown, Error output	5-Pin SOT-23A
TC1187	6.0	1.23 → V _{IN}	150	-40 to +125	50	270	—	Shutdown, Adjustable	5-Pin SOT-23A
TC1017	6.0	1.8, 2.6, 2.7, 2.8, 2.85, 2.9, 3.3, 3.4	150	-40 to +125	53	285	±0.5	Shutdown	5-Pin SOT-23A, 5-Pin SC-70
MCP1700	6.0	1.2, 1.8, 2.5, 3.0, 3.3, 5.0	250	-40 to +125	1.0	300	±0.4	1.0 µF ceramic cap stable, Short-circuit protection	3-Pin TO-92, 3-Pin SOT-23A, 3-Pin SOT-89
MCP1701	10	1.8, 2.5, 3.0, 3.3, 5.0	250	-40 to +85	1.1	380	±0.5	10V max. input voltage	3-Pin SOT-23A, 3-Pin SOT-89, 3-Pin TO-92
MCP1702	12	1.2, 1.5, 1.8, 2.5, 2.8, 3.0, 3.5, 4.0, 5.0	250	-40 to +125	2	650	±0.4	Ultra-low ground current, 12V V _{IN} max.	3-Pin SOT-23A, 3-Pin SOT-89, 3-Pin TO-92

- NOTE** 1: Depending on external transistor configuration.
2: Each channel (for Dual and Quad LDOs).
3: LDOs with shutdown (except Power-Management Combination Products as indicated) have typical shutdown currents of 0.05 µA.

POWER MANAGEMENT – Linear Regulators (continued)

Part #	Max. Input Voltage (V)	Output Voltage (V)	Output Current (mA)	Junction Temperature Range (°C)	Typical Active Current (μA)	Typical Dropout Voltage @ Max. I _{OUT} (mV)	Typical Output Voltage Accuracy (%)	Features	Packages
300 mA Low Dropout Linear Regulators									
TC1107	6.0	2.5, 2.7, 2.8, 3.0, 3.3, 5.0	300	-40 to +125	50	240	±0.5	Shutdown, Reference bypass input	8-Pin MSOP, 8-Pin SOIC
TC1108	6.0	2.5, 2.7, 2.8, 3.0, 3.3, 5.0	300	-40 to +125	50	240	±0.5		3-Pin SOT-223
TC1173	6.0	2.5, 2.7, 2.8, 3.0, 3.3, 5.0	300	-40 to +125	50	240	±0.5	Shutdown, Reference bypass input, Error output	8-Pin MSOP, 8-Pin SOIC
TC1174	6.0	1.23 → V _{IN}	300	-40 to +125	50	240	—	Shutdown, Reference bypass input, Adjustable	8-Pin MSOP, 8-Pin SOIC
TC1269	6.0	2.5, 2.8, 3.0, 3.3, 5.0	300	-40 to +125	50	240	±0.5	Shutdown, Reference bypass input	8-Pin MSOP
500 mA to 800 mA Low Dropout Linear Regulators									
TC1262	6.0	2.5, 2.8, 3.0, 3.3, 5.0	500	-40 to +125	80	350	±0.5		3-Pin TO-220, 3-Pin DDPAK, 3-Pin SOT-223
TC1263	6.0	2.5, 2.8, 3.0, 3.3, 5.0	500	-40 to +125	80	350	±0.5	Shutdown, Reference bypass input, Error output	8-Pin SOIC, 5-Pin TO-220, 5-Pin DDPAK
TC1268	6.0	2.5	500	-40 to +125	80	350	±0.5	Shutdown, Reference bypass input, Error output	8-Pin SOIC
TC1264	6.0	1.8, 2.5, 3.0, 3.3	800	-40 to +125	80	450	±0.5		3-Pin TO-220, 3-Pin DDPAK, 3-Pin SOT-223
TC1265	6.0	1.8, 2.5, 3.0, 3.3	800	-40 to +125	80	450	±0.5	Shutdown, Reference bypass input, Error output	8-Pin SOIC, 5-Pin TO-220, 5-Pin DDPAK
TC2117	6.0	1.8, 2.5, 3.0, 3.3	800	-40 to +125	80	600	±0.5		3-Pin SOT-223, 3-Pin DDPAK
1A and Above Low Dropout Linear Regulators									
MCP1726	6.0	Fixed: 5, 3.3, 3, 2.5, 1.8, 1.2, 0.8 Adjustable: 0.8 to 5.0	1000	-40 to +125	140	300	±0.4	Ceramic output capacitor stable, Shutdown, C _{delay} , Power Good	8-Pin 3x3 DFN, 8-Pin SOIC
Application Specific Low Dropout Linear Regulators									
TC1266	6.0	3.3	200	-5 to +70	230	200	±1.0	PCI compliant	8-Pin SOIC, 8-Pin MSOP
TC1267	6.0	3.3	400	-5 to +70	230	300	±1.0	PCI compliant	5-Pin DDPAK
TC57	8	2.5, 3.0, 3.3	4,000 ⁽¹⁾	-40 to +85	50	100 ⁽¹⁾	±2.0	Shutdown, External transistor	5-Pin SOT-23A
TC59	-10	-3.0, -5.0	100	-40 to +85	3	380	±0.5	Negative LDO	3-Pin SOT-23A
Power Management Combination Products									
TC1300 ⁽³⁾	6.0	2.5, 2.7, 2.8, 2.85, 3.0, 3.3	300	-40 to +125	80	210	±0.5	Shutdown, Reference bypass input, LDO plus Reset output	8-Pin MSOP
TC1301A ⁽³⁾	6.0	LDO1: 1.5-3.3 LDO2: 1.5-3.3	LDO1: 300 LDO2: 150	-40 to +125	103	LDO1: 104 LDO2: 150	±0.5	Dual LDO plus Reset output, Shutdown, Reference bypass, Voltage detect	8-Pin MSOP, 8-Pin 3x3 DFN
TC1301B ⁽³⁾	6.0	LDO1: 1.5-3.3 LDO2: 1.5-3.3	LDO1: 300 LDO2: 150	-40 to +125	114	LDO1: 104 LDO2: 150	±0.5	Dual LDO plus Reset, per channel output shutdown, Reference bypass	8-Pin MSOP, 8-Pin 3x3 DFN
TC1302A ⁽³⁾	6.0	LDO1: 1.5-3.3 LDO2: 1.5-3.3	LDO1: 300 LDO2: 150	-40 to +125	103	LDO1: 104 LDO2: 150	±0.5	Dual LDO, Output shutdown reference bypass, Voltage detect	8-Pin MSOP, 8-Pin 3x3 DFN

NOTE 1: Depending on external transistor configuration.

NOTE 2: Each channel (for Dual and Quad LDOs).

NOTE 3: LDOs with shutdown (except Power-Management Combination Products as indicated) have typical shutdown currents of 0.05 μA.

POWER MANAGEMENT – Linear Regulators (continued)

Part #	Max. Input Voltage (V)	Output Voltage (V)	Output Current (mA)	Junction Temperature Range (°C)	Typical Active Current (µA)	Typical Dropout Voltage @ Max. I _{OUT} (mV)	Typical Output Voltage Accuracy (%)	Features	Packages
Power-Management Combination Products (continued)									
TC1302B ⁽³⁾	6.0	LDO1: 1.5-3.3 LDO2: 1.5-3.3	LDO1: 300 LDO2: 150	-40 to +125	114	LDO1: 104 LDO2: 150	±0.5	Dual LDO, per channel output shutdown, Reference bypass	8-Pin MSOP, 8-Pin 3x3 DFN
TC1305	6.0	2.5, 2.8, 3.0	150 ⁽²⁾	-40 to +125	120	240	±0.5	Dual LDO plus Reset output, Reference bypass input, Shutdown, Select Mode™ selectable output voltages	10-Pin MSOP
TC1306	6.0	1.8, 2.8, 3.0	150 ⁽²⁾	-40 to +125	120	240	±0.5	Dual LDO plus Reset output, Shutdown, Select Mode™ selectable output voltages	8-Pin MSOP
TC1307 ⁽³⁾	6.0	1.8, 2.5, 2.8, 3.0	150 ⁽²⁾	-40 to +125	220	200	±0.5	Quad LDO plus Reset output, Shutdown, Select Mode™ selectable output voltage	16-Pin QSOP

- NOTE** 1: Depending on external transistor configuration.
 2: Each channel (for Dual and Quad LDOs).
 3: LDOs with shutdown (except Power-Management Combination Products as indicated) have typical shutdown currents of 0.05 µA.

POWER MANAGEMENT – Switching Regulators

Part #	Description	Input Voltage Range (V)	Output Voltage (V)	Operating Temperature Range (°C)	Control Scheme	Switching Frequency (kHz)	Typical Active Current (µA)	Output Current (mA)	Features	Packages
MCP1601	Synchronous Buck Regulator	2.7 to 5.5	0.9V to V _{IN}	-40 to +85	PFM/PWM/LDO	750	825 (PWM) 125 (PFM)	500	UVLO, Auto-switching, LDO	8-Pin MSOP
MCP1612	Synchronous Buck DC/DC Regulator	2.7 to V _{IN}	0.8 to 5.5	-40 to +85	Constant frequency PWM	1400	10,000	1000	Overall efficiency >94% soft start, over-temperature and over-current protection	8-Pin MSOP, 8-Pin 3x3 DFN
MCP1650	Step-up DC/DC Controller	2.7 to 5.5	2.5 to ext. tx limited	-40 to +125	Constant frequency, 2 fixed DC	750	120	560/440	2 duty cycles for min. and max. loads, shutdown control, UVLO, soft start	8-Pin MSOP
MCP1651	Step-up DC/DC Controller	2.7 to 5.5	2.5 to ext. tx limited	-40 to +125	Constant frequency, 2 fixed DC	750	120	560/440	2 duty cycles for min. and max. loads, shutdown control, low battery detect, UVLO, soft start	8-Pin MSOP
MCP1652	Step-up DC/DC Controller	2.7 to 5.5	2.5 to ext. tx limited	-40 to +125	Constant frequency, 2 fixed DC	750	120	560/440	2 duty cycles for min. and max. loads, shutdown control, Power Good indicator, UVLO, soft start	8-Pin MSOP
MCP1653	Step-up DC/DC Controller	2.7 to 5.5	2.5 to ext. tx limited	-40 to +125	Constant frequency, 2 fixed DC	750	120	560/440	2 duty cycles for min. and max. loads, shutdown control, low battery detect, Power Good indicator, UVLO, soft start	10-Pin MSOP
TC105	Step-down DC/DC Controller	2.2 to 10	3.0, 3.3, 5.0	-40 to +85	PFM/PWM	300	57	1,000	Low-Power Shutdown mode	5-Pin SOT-23A
TC120	Step-down Regulator/Controller Combination	1.8 to 10	3.0, 3.3, 5.0	-40 to +85	PFM/PWM	300	52	2,000	Soft-start, Low-Power Shutdown mode	8-Pin SOP
TC125	Step-up DC/DC Regulator	0.9 to 10	3.0, 3.3, 5.0	-40 to +85	PFM	100	20	80	Low-Power Shutdown mode	5-Pin SOT-23A
TC126	Step-up DC/DC Regulator	0.9 to 10	3.0, 3.3, 5.0	-40 to +85	PFM	100	20	80	Feedback voltage sensing	5-Pin SOT-23A
TC115	Step-up DC/DC Regulator	0.9 to 10	3.0, 3.3, 5.0	-40 to +85	PFM/PWM	100	80	140	Feedback voltage sensing, Low-Power Shutdown mode	5-Pin SOT-89
TC110	Step-up DC/DC Controller	2.0 to 10	3.0, 3.3, 5.0	-40 to +85	PFM/PWM	100/300	50/120	300	Soft-start, Low-Power Shutdown mode	5-Pin SOT-23A
TC1303	Synchronous Buck Regulator, LDO w/Power Good	2.7 to 5.5	DC/DC: 0.8 to 4.5 LDO: 1.5 to 3.3	-40 to +85	PFM/PWM	2000	65/600	DC/DC: 500 mA LDO: 300 mA	PFM/PWM auto-switching, Power Good output	10-Pin MSOP, 10-Pin 3x3 DFN

POWER MANAGEMENT – Switching Regulators (continued)

Part #	Description	Input Voltage Range (V)	Output Voltage (V)	Operating Temperature Range (°C)	Control Scheme	Switching Frequency (kHz)	Typical Active Current (µA)	Output Current (mA)	Features	Packages
TC1304	Synchronous Buck Regulator, LDO	2.7 to 5.5	DC/DC: 0.8 to 4.5 LDO: 1.5 to 3.3	-40 to +85	PFM/PWM	2000	65/600	DC/DC: 500 mA LDO: 300 mA	PFM/PWM auto-switching, Power sequencing	10-Pin MSOP, 10-Pin 3x3 DFN
TC1313	Synchronous Buck Regulator, LDO	2.7 to 5.5	DC/DC: 0.8 to 4.5 LDO: 1.5 to 3.3	-40 to +85	PFM/PWM	2000	65/600	DC/DC: 500 mA LDO: 300 mA	PFM/PWM auto-switching	10-Pin MSOP, 10-Pin 3x3 DFN

POWER MANAGEMENT – PWM Controllers

Part #	Description	Input Voltage Range (V)	Output Voltage (V)	Operating Temperature Range (°C)	Control Scheme	Switching Frequency (kHz)	Typical Active Supply (µA)	Output Current (mA)	Features	Packages
MCP1630	High-speed PWM to use with PIC® MCUs	2.7 to 5.5	V _{SS} + 0.2V to V _{DD} - 0.2V	-40 to +125	Cycle-by-Cycle DC control	1000	2.5	±10	UVLO, current sense to V _{EXT} , response <25 ns	8-Pin MSOP
MCP1630V	High-speed PWM to use with PIC® MCUs	2.7 to 5.5	V _{SS} + 0.2V to V _{DD} - 0.2V	-40 to +125	Cycle-by-Cycle DC control	1000	2.5	±10	Voltage mode and Average Current mode	8-Pin MSOP

POWER MANAGEMENT – Charge Pump DC-to-DC Converters

Part #	Input Voltage Range (V)	Output Voltage (V)	Operating Temperature Range (°C)	Maximum Input Current ⁽¹⁾ (µA)	Typical Active Output Current (mA)	Features	Packages
Inverting or Doubling Charge Pumps							
TC1044S	1.5 to 12	V _{OUT} = -V _{IN} or V _{OUT} = 2 V _{IN}	-40 to +85	160	20	85 kHz oscillator, Boost mode	8-Pin PDIP, 8-Pin SOIC
TC7660	1.5 to 10	V _{OUT} = -V _{IN} or V _{OUT} = 2 V _{IN}	-40 to +85	180	20	10 kHz oscillator	8-Pin PDIP, 8-Pin SOIC
TC7660H	1.5 to 10	V _{OUT} = -V _{IN} or V _{OUT} = 2 V _{IN}	-40 to +85	1,000	20	120 kHz oscillator	8-Pin PDIP, 8-Pin SOIC
TC7660S	1.5 to 12	V _{OUT} = -V _{IN} or V _{OUT} = 2 V _{IN}	-40 to +85	160	20	45 kHz oscillator, Boost mode	8-Pin PDIP, 8-Pin SOIC
TC7662B	1.5 to 15	V _{OUT} = -V _{IN} or V _{OUT} = 2 V _{IN}	-40 to +85	180	20	35 kHz oscillator, Boost mode	8-Pin PDIP, 8-Pin SOIC
TC1219	1.5 to 5.5	V _{OUT} = -V _{IN} or V _{OUT} = 2 V _{IN}	-40 to +85	115	25	12 kHz oscillator, Low-Power Shutdown mode	6-Pin SOT-23A
TC1220	1.5 to 5.5	V _{OUT} = -V _{IN} or V _{OUT} = 2 V _{IN}	-40 to +85	325	25	35 kHz oscillator, Low-Power Shutdown mode	6-Pin SOT-23A
TC1221	1.8 to 5.5	V _{OUT} = -V _{IN} or V _{OUT} = 2 V _{IN}	-40 to +85	600	25	Shutdown, 125 kHz oscillator	6-Pin SOT-23A
TC1222	1.8 to 5.5	V _{OUT} = -V _{IN} or V _{OUT} = 2 V _{IN}	-40 to +85	2,800	25	Shutdown, 750 kHz oscillator	6-Pin SOT-23A
TCM828	1.5 to 5.5	V _{OUT} = -V _{IN} or V _{OUT} = 2 V _{IN}	-40 to +85	90	25	12 kHz oscillator	5-Pin SOT-23A
TCM829	1.5 to 5.5	V _{OUT} = -V _{IN} or V _{OUT} = 2 V _{IN}	-40 to +85	260	25	35 kHz oscillator	5-Pin SOT-23A
TC1240	2.5 to 4.0	V _{OUT} = 2 V _{IN}	-40 to +85	900	40	Shutdown, 160 kHz oscillator	6-Pin SOT-23A
TC1240A	2.5 to 5.5	V _{OUT} = 2 V _{IN}	-40 to +85	900	40	Shutdown, 160 kHz oscillator	6-Pin SOT-23A
TC7662A	3 to 18	V _{OUT} = -V _{IN} or V _{OUT} = 2 V _{IN}	-40 to +85	200	40	12 kHz oscillator	8-Pin PDIP
TC962	3 to 18	V _{OUT} = -V _{IN} or V _{OUT} = 2 V _{IN}	-40 to +85	200	80		8-Pin PDIP, 16-Pin SOIC
TC1121	2.4 to 5.5	V _{OUT} = -V _{IN} or V _{OUT} = 2 V _{IN}	-40 to +85	100	100	Low-Power Shutdown mode	8-Pin MSOP, 8-Pin PDIP, 8-Pin SOIC

NOTE 1: Measured at V_{DD} = 5.0V at 25°C and no load.

POWER MANAGEMENT – Charge Pump DC-to-DC Converters (continued)

Part #	Input Voltage Range (V)	Output Voltage (V)	Operating Temperature Range (°C)	Maximum Input Current ⁽¹⁾ (μA)	Typical Active Output Current (mA)	Features	Packages
Multi-Function Charge Pumps							
TCM680	2.0 to 5.5	V _{OUT} = ±2 V _{IN}	-40 to +85	1,000	±10	Generates ±6V from +3V or ±10V from +5V	8-Pin PDIP, 8-Pin SOIC
Inverting and Doubling Charge Pumps							
TC682	2.4 to 5.5	V _{OUT} = -2 V _{IN}	-40 to +85	400	10	12 kHz oscillator	8-Pin PDIP, 8-Pin SOIC
Regulated Charge Pumps							
MCP1252	2.1/2.7 to 5.5 2.0 to 5.5	Selectable 3.3V or 5.0V or Adjustable 1.5V to 5.5V	-40 to +85	120	120 mA for V _{IN} >3.0V	Power Good output, 650 kHz oscillator	8-Pin MSOP
MCP1253	2.1/2.7 to 5.5 2.0 to 5.5	Selectable 3.3V or 5.0V or Adjustable 1.5V to 5.5V	-40 to +85	120	120 mA for V _{IN} >3.0V	Power Good output, 1 MHz oscillator	8-Pin MSOP
MCP1256	1.8 to 3.6	3.3	-40 to +85	100	100	Power Good, Sleep mode	10-Pin MSOP, 10-Pin 3x3 DFN
MCP1257	1.8 to 3.6	3.3	-40 to +85	100	100	Sleep mode, low battery indication	10-Pin MSOP, 10-Pin 3x3 DFN
MCP1258	1.8 to 3.6	3.3	-40 to +85	100	100	Power Good output, input/output bypass	10-Pin MSOP, 10-Pin 3x3 DFN
MCP1259	1.8 to 3.6	3.3	-40 to +85	100	100	Low battery indication, input/output bypass	10-Pin MSOP, 10-Pin 3x3 DFN

NOTE 1: Measured at V_{DD} = 5.0V at 25°C and no load.

POWER MANAGEMENT – CPU/System Supervisors

Part #	V _{CC} Range (V)	Operating Temperature Range (°C)	Nominal Reset Voltage (V)	Reset Type	Output	Typical Reset Pulse Width (ms)	Typical Supply Current (μA)	Additional Features	Packages	Bond Options
MCP102	1.0 to 5.5	-40 to +125	4.63, 4.38, 3.08, 2.93, 2.63, 2.32, 1.9	Active Low	CMOS Push-Pull	120	1		3-Pin SOT-23B, 3-Pin SC-70, 3-Pin TO-92	N/A
MCP103	1.0 to 5.5	-40 to +125	4.63, 4.38, 3.08, 2.93, 2.63, 2.32, 1.9	Active Low	CMOS Push-Pull	120	1	Max. 809 Pinout	3-Pin SOT-23B, 3-Pin SC-70, 3-Pin TO-92	N/A
TC1272	1.2 to 5.5	-40 to +85	4.62, 4.37, 4.12	Active Low	CMOS Push-Pull	200	17		3-Pin SOT-23B	N/A
TC1275	1.2 to 5.5	-40 to +85	3.06, 2.88, 2.55	Active Low	CMOS Push-Pull	200	20		3-Pin SOT-23B	N/A
TCM809	1.2 to 5.5	-40 to +85	4.63, 4.38, 4.00, 3.08, 2.93, 2.63, 2.32	Active Low	CMOS Push-Pull	240	12		3-Pin SOT-23B, 3-Pin SC-70	N/A
TC1270	1.2 to 5.5	-40 to +85	4.63, 4.38, 3.08, 2.93, 2.63, 1.75	Active Low	CMOS Push-Pull	280	7	Manual Reset	4-Pin SOT-143	N/A
TCM811	1.0 to 5.5	-40 to +85	4.63, 4.38, 3.08, 2.93, 2.63, 1.75	Active Low	CMOS Push-Pull	280	6	Manual Reset	4-Pin SOT-143	N/A
MCP100	1.0 to 5.5	-40 to +85	4.72, 4.62, 4.47, 4.37, 3.075, 2.92, 2.62	Active Low	CMOS Push-Pull	350	45		3-Pin TO-92, 3-Pin SOT-23B	D, H
MCP809	1.0 to 5.5	-40 to +85	4.72, 4.62, 4.47, 4.37, 3.075, 2.92, 2.62	Active Low	CMOS Push-Pull	350	45		3-Pin SOT-23B	N/A
TC1274	1.8 to 5.5	-40 to +85	4.62, 4.37, 4.13	Active High	CMOS Push-Pull	200	17		3-Pin SOT-23B	N/A
TC1277	1.8 to 5.5	-40 to +85	3.06, 2.88, 2.55	Active High	CMOS Push-Pull	200	20		3-Pin SOT-23B	N/A
TCM810	1.2 to 5.5	-40 to +85	4.63, 4.38, 3.08, 2.93, 2.63, 2.32	Active High	CMOS Push-Pull	240	12		3-Pin SOT-23B, 3-Pin SC-70	N/A
TC1271	1.2 to 5.5	-40 to +85	4.63, 4.38, 3.08, 2.93, 2.63, 1.75	Active High	CMOS Push-Pull	280	7	Manual Reset	4-Pin SOT-143	N/A
TCM812	1.1 to 5.5	-40 to +85	4.63, 4.38, 3.08, 2.93, 2.63, 1.75	Active High	CMOS Push-Pull	280	6	Manual Reset	4-Pin SOT-143	N/A
MCP101	1.0 to 5.5	-40 to +85	4.72, 4.62, 4.47, 4.37, 3.075, 2.92, 2.62	Active High	CMOS Push-Pull	350	45		3-Pin TO-92, 3-Pin SOT-23B	D, H
MCP810	1.0 to 5.5	-40 to +85	4.72, 4.62, 4.47, 4.37, 3.075, 2.92, 2.62	Active High	CMOS Push-Pull	350	45		3-Pin SOT-23B	N/A

POWER MANAGEMENT – CPU/System Supervisors (continued)

Part #	Vcc Range (V)	Operating Temperature Range (°C)	Nominal Reset Voltage (V)	Reset Type	Output	Typical Reset Pulse Width (ms)	Typical Supply Current (µA)	Additional Features	Packages	Bond Options
MCP121	1.0 to 5.5	-40 to +125	1.9, 2.32, 2.63, 2.93, 3.08, 4.38, 4.63	Active Low	Open-drain	120	1		3-Pin SOT-23B, 3-Pin SC-70, 3-Pin TO-92	N/A
TC1273	1.2 to 5.5	-40 to +85	4.62, 4.37, 4.12	Active Low	Open-drain	200	17		3-Pin SOT-23B	N/A
TC1276	1.2 to 5.5	-40 to +85	3.06, 2.88, 2.55	Active Low	Open-drain	200	20		3-Pin SOT-23B	N/A
MCP120	1.0 to 5.5	-40 to +85	4.72, 4.62, 4.47, 4.37, 3.075, 2.92, 2.62	Active Low	Open-drain	350	45		3-Pin TO-92, 3-Pin SOT-23, 8-Pin SOIC	D, G, H
TC1279	1.2 to 5.5	-40 to +85	4.62, 4.37, 4.125	Active Low	Open-drain	350	900		3-Pin SOT-23B	N/A
MCP131	1.0 to 5.5	-40 to +125	1.9, 2.32, 2.63, 2.93, 3.08, 4.38, 4.63	Active Low	Open-drain	120	1	100kΩ Internal Pull-up Resistor	3-Pin SOT-23B, 3-Pin SC-70, 3-Pin TO-92	N/A
MCP130	1.0 to 5.5	-40 to +85	4.72, 4.62, 4.47, 4.37, 3.075, 2.92, 2.62	Active Low	Open-drain w/ 5 kΩ Pull-up	350	45		3-Pin TO-92, 3-Pin SOT-23, 8-Pin SOIC	D, F, H
TC1278	1.2 to 5.5	-40 to +85	4.62, 4.37, 4.125	Active High	Open-drain	350	900		3-Pin SOT-23B	N/A
MCP1316	1.0 to 5.5	-40 to +125	2.9, 4.6	Active Low	CMOS Push-Pull	200	5	Watchdog Input (WDI), Timeout = 1.6 sec., Manual reset	5-Pin SOT-23	N/A
MCP1317	1.0 to 5.5	-40 to +125	2.9, 4.6	Active High	CMOS Push-Pull	200	5	Watchdog Input (WDI), Timeout = 1.6 sec., Manual reset	5-Pin SOT-23	N/A
MCP1318	1.0 to 5.5	-40 to +125	4.6	Active Low/High	CMOS Push-Pull	200	5	Watchdog Input (WDI), Timeout = 1.6 sec.	5-Pin SOT-23	N/A
MCP1319	1.0 to 5.5	-40 to +125	4.6	Active Low/High	CMOS Push-Pull	200	1	Manual reset	5-Pin SOT-23	N/A
MCP1320	1.0 to 5.5	-40 to +125	2.9, 4.6	Active Low	Open-drain	200	5	Watchdog Input (WDI), Timeout = 1.6 sec., Manual reset	5-Pin SOT-23	N/A
MCP1321	1.0 to 5.5	-40 to +125	4.6	Active Low	Open-drain/CMOS Push-Pull	200	5	Watchdog Input (WDI), Timeout = 1.6 sec., Manual reset (Active Low Open-drain, Active-High Push-Pull)	5-Pin SOT-23	N/A
MCP1322	1.0 to 5.5	-40 to +125	4.6	Active High	Open-drain/CMOS Push-Pull	200	1	Manual reset, two reset outputs (Active Low Open-drain, Active High Push-Pull)	5-Pin SOT-23	N/A
TC1232	4.5 to 5.5	-40 to +85	4.62, 4.37	Active Low/High	Open-drain	610	50	Watchdog Timer	8-Pin PDIP, 8-Pin SOIC, 16-Pin SOIC	N/A
TC32M	4.5 to 5.5	-40 to +85	4.5	Active Low	Open-drain	700	50	Watchdog Timer	3-Pin TO-92, 3-Pin SOT-223	N/A

POWER MANAGEMENT – Voltage Detectors

Part #	Vcc Range (V)	Operating Temperature Range (°C)	Nominal Reset Voltage (V)	Reset Type	Output	Minimum Reset Pulse Width (ms)	Typical Supply Current (µA)	Features	Packages
MCP111	1.0 to 5.5	-40 to +125	4.63, 4.38, 3.08, 2.93, 2.63, 2.32, 1.90	Active Low	Open-drain	—	1		3-Pin SOT-23B, 3-Pin TO-92, 3-Pin SC-70, 3-Pin SOT-89
MCP112	1.0 to 5.5	-40 to +125	4.63, 4.38, 3.08, 2.93, 2.63, 2.32, 1.90	Active Low	CMOS Push-Pull	—	1		3-Pin SOT-23B, 3-Pin TO-92, 3-Pin SC-70, 3-Pin SOT-89

POWER MANAGEMENT – Voltage Detectors (continued)

Part #	Vcc Range (V)	Operating Temperature Range (°C)	Nominal Reset Voltage (V)	Reset Type	Output	Minimum Reset Pulse Width (ms)	Typical Supply Current (µA)	Features	Packages
TC51	0.7 to 10	-40 to +85	3.0, 2.7, 2.2	Active Low	Open-drain	50	1	Reset delay	3-Pin SOT-23A
TC52	1.5 to 10	-40 to +85	4.5/2.7, 3.0/2.7	Active Low	Open-drain	—	2	Dual channel	5-Pin SOT-23A
TC53	1.5 to 10	-40 to +85	2.9, 2.7, 2.2	Active Low	CMOS Push-Pull or Open-drain	—	1		5-Pin SOT-23A
TC54	0.7 to 10	-40 to +85	7.7, 4.3, 4.2, 3.0, 2.9, 2.7, 2.1, 1.4	Active Low	CMOS Push-Pull or Open-drain	—	1		3-Pin SOT-23A, 3-Pin SOT-89, 3-Pin TO-92

POWER MANAGEMENT – Power MOSFET Drivers

Part #	Configuration	Operating Temperature Range (°C)	Peak Output Current (A)	Output Resistance (RH/RL) (Max. Ω @ 25°C)	Max. Supply Voltage (V)	Input/Output Delay (td1, td2) ⁽¹⁾ (ns)	Packages
Low-Side Drivers, 0.5A to 1.2A Peak Output Current							
TC1410	Single, Inverting	-40 to +85	0.5	22/22	16	30/30	8-Pin PDIP, 8-Pin SOIC, 8-Pin MSOP
TC1410N	Single, Non-inverting	-40 to +85	0.5	22/22	16	30/30	8-Pin PDIP, 8-Pin SOIC, 8-Pin MSOP
TC1411	Single, Inverting	-40 to +85	1	11/11	16	30/30	8-Pin PDIP, 8-Pin SOIC, 8-Pin MSOP
TC1411N	Single, Non-inverting	-40 to +85	1	11/11	16	30/30	8-Pin PDIP, 8-Pin SOIC, 8-Pin MSOP
TC1426	Dual, Inverting	0 to +70	1.2	18/18	16	75/75	8-Pin PDIP, 8-Pin SOIC
TC1427	Dual, Non-inverting	0 to +70	1.2	18/18	16	75/75	8-Pin PDIP, 8-Pin SOIC
TC1428	Dual, Inverting and Non-inverting	0 to +70	1.2	18/18	16	75/75	8-Pin PDIP, 8-Pin SOIC
TC4467	Quad, Inverting	-40 to +85	1.2	15/15	18	40/40	14-Pin PDIP, 16-Pin SOIC (W)
TC4468	Quad, Non-inverting	-40 to +85	1.2	15/15	18	40/40	14-Pin PDIP, 16-Pin SOIC (W)
TC4469	Quad, Non-inverting	-40 to +85	1.2	15/15	18	40/40	14-Pin PDIP, 16-Pin SOIC (W)
Low-Side Drivers, 1.5A Peak Output Current							
TC4403	Single, Non-inverting Floating Load Driver	-40 to +85	1.5	5/5	18	33/38	8-Pin PDIP
TC4426A	Dual, Inverting	-40 to +125	1.5	9/9	18	30/30	8-Pin PDIP, 8-Pin SOIC, 8-Pin DFN
TC4427A	Dual, Non-inverting	-40 to +125	1.5	9/9	18	30/30	8-Pin PDIP, 8-Pin SOIC, 8-Pin DFN
TC4428A	Dual, Inverting and Non-inverting	-40 to +125	1.5	9/9	18	30/30	8-Pin PDIP, 8-Pin SOIC, 8-Pin DFN
TC4426	Dual, Inverting	-40 to +125	1.5	10/10	18	20/40	8-Pin PDIP, 8-Pin SOIC, 8-Pin DFN, 8-Pin MSOP
TC4427	Dual, Non-inverting	-40 to +125	1.5	10/10	18	20/40	8-Pin PDIP, 8-Pin SOIC, 8-Pin DFN, 8-Pin MSOP
TC4428	Dual, Inverting and Non-inverting	-40 to +125	1.5	10/10	18	20/40	8-Pin PDIP, 8-Pin SOIC, 8-Pin DFN, 8-Pin MSOP
TC426	Dual, Inverting	-40 to +85	1.5	15/10	18	50/75	8-Pin PDIP, 8-Pin SOIC
TC427	Dual, Non-inverting	-40 to +85	1.5	15/10	18	50/75	8-Pin PDIP, 8-Pin SOIC
TC428	Dual, Inverting and Non-inverting	-40 to +85	1.5	15/10	18	50/75	8-Pin PDIP, 8-Pin SOIC
TC4404	Dual, Inverting	-40 to +85	1.5	10/10	18	15/32	8-Pin PDIP, 8-Pin SOIC
TC4405	Dual, Non-inverting	-40 to +85	1.5	10/10	18	15/32	8-Pin PDIP, 8-Pin SOIC

NOTE 1: *td1 = delay time from input low-to-high transition to output transition. td2 = delay time from input high-to-low transition to output transition.

POWER MANAGEMENT – Power MOSFET Drivers (continued)

Part #	Configuration	Operating Temperature Range (°C)	Peak Output Current (A)	Output Resistance (RH/RL) (Max. Ω @ 25°C)	Max. Supply Voltage (V)	Input/Output Delay (td1, td2) ⁽¹⁾ (ns)	Packages
Low-Side Drivers, 2.0A to 12.0A Peak Output Current							
TC1412	Single, Inverting	-40 to +85	2	6/6	16	35/35	8-Pin PDIP, 8-Pin SOIC, 8-Pin MSOP
TC1412N	Single, Non-inverting	-40 to +85	2	6/6	16	35/35	8-Pin PDIP, 8-Pin SOIC, 8-Pin MSOP
TC1413	Single, Inverting	-40 to +85	3	4/4	16	35/35	8-Pin PDIP, 8-Pin SOIC, 8-Pin MSOP
TC1413N	Single, Non-inverting	-40 to +85	3	4/4	16	35/35	8-Pin PDIP, 8-Pin SOIC, 8-Pin MSOP
TC4423A	Dual, Inverting	-40 to +125	3	3 (typ)/4 (typ)	18	40 (typ)/40 (typ)	8-Pin PDIP, 8-Pin SOIC, 8-Pin DFN
TC4424A	Dual, Non-inverting	-40 to +125	3	3 (typ)/4 (typ)	18	40 (typ)/40 (typ)	8-Pin PDIP, 8-Pin SOIC, 8-Pin DFN
TC4425A	Dual, Inverting and Non-inverting	-40 to +125	3	3 (typ)/4 (typ)	18	40 (typ)/40 (typ)	8-Pin PDIP, 8-Pin SOIC, 8-Pin DFN
TC4423	Dual, Inverting	-40 to +125	3	5/5	18	33/38	8-Pin PDIP, 16-Pin SOIC (W), 8-Pin DFN
TC4424	Dual, Non-inverting	-40 to +125	3	5/5	18	33/38	8-Pin PDIP, 16-Pin SOIC (W), 8-Pin DFN
TC4425	Dual, Inverting and Non-inverting	-40 to +125	3	5/5	18	33/38	8-Pin PDIP, 16-Pin SOIC (W), 8-Pin DFN
TC429	Single, Inverting	-40 to +85	6	2.5/2.5	18	53/60	8-Pin PDIP, 8-Pin DFN, 8-Pin SOIC
TC4420	Single, Non-inverting	-40 to +125	6	2.8/2.5	18	55/55	8-Pin PDIP, 8-Pin SOIC, 5-Pin TO-220, 8-Pin DFN
TC4429	Single, Inverting	-40 to +125	6	2.8/2.5	18	55/55	8-Pin PDIP, 8-Pin SOIC, 5-Pin TO-220, 8-Pin DFN
TC4421	Single, Inverting	-40 to +125	9	1.4 (typ)/1.7	18	30/33	8-Pin PDIP, 5-Pin TO-220, 8-Pin DFN
TC4421A	Single, Inverting	-40 to +125	9	1.25 (typ)/1.5	18	38/42	8-Pin PDIP, 8-Pin SOIC, 5-Pin TO-220, 8-Pin 6x5 DFN
TC4422	Single, Non-inverting	-40 to +125	9	1.4 (typ)/1.7	18	30/33	8-Pin PDIP, 5-Pin TO-220, 8-Pin DFN
TC4422A	Single, Non-inverting	-40 to +125	9	1.25 (typ)/1.5	18	38/42	8-Pin PDIP, 8-Pin SOIC, 5-Pin TO-220, 8-Pin 6x5 DFN
TC4451	Single, Inverting	-40 to +125	12	0.6 (typ)/1.5	18	15/15	8-Pin SOIC, 8-Pin PDIP, 8-Pin 6x5 DFN, 5-Pin TO-220, 5-Pin DDPACK
TC4452	Single, Non-inverting	-40 to +125	12	0.6 (typ)/1.5	18	15/15	8-Pin SOIC, 8-Pin PDIP, 8-Pin 6x5 DFN, 5-Pin TO-220, 5-Pin DDPACK
High-Side/Low-Side Drivers							
TC4626	Single, Inverting	-40 to +85	1.5	15/10	6	35/45	8-Pin PDIP, 16-Pin SOIC (W)
TC4627	Single, Non-inverting	-40 to +85	1.5	15/10	6	35/45	8-Pin PDIP, 16-Pin SOIC (W)
TC4431	Single, Inverting	-40 to +85	1.5	10/10	30	62/78	8-Pin PDIP, 8-Pin SOIC
TC4432	Single, Non-inverting	-40 to +85	1.5	10/10	30	62/78	8-Pin PDIP, 8-Pin SOIC

NOTE 1: *td1 = delay time from input low-to-high transition to output transition. td2 = delay time from input high-to-low transition to output transition.

POWER MANAGEMENT – Battery Chargers

Part #	Mode	Cell Type	# of Cells	Vcc Range (V)	Max. Voltage Regulation (%)	Int/Ext FET	Features	Packages
MCP73826	Linear	Li-Ion/Li-Polymer	1	4.5 to 5.5	±1.0	Ext	Small size	6-Pin SOT-23
MCP73827	Linear	Li-Ion/Li-Polymer	1	4.5 to 5.5	±1.0	Ext	Mode indicator, Charge Current monitor	8-Pin MSOP
MCP73828	Linear	Li-Ion/Li Polymer	1	4.5 to 5.5	±1.0	Ext	Temperature monitor	8-Pin MSOP

POWER MANAGEMENT – Battery Chargers (continued)

Part #	Mode	Cell Type	# of Cells	Vcc Range (V)	Max. Voltage Regulation (%)	Int/Ext FET	Features	Packages
MCP73831	Linear	Li-Ion/Li-Polymer	1	3.7 to 6.0	±0.75	Int	UVLO, Thermal regulation, Programmable charge current, 4.2, 4.35, 4.4 and 4.5V VREG options	5-Pin SOT-23, 8-Pin 2x3 DFN
MCP73841	Linear	Li-Ion/Li-Polymer	1	4.5 to 12	±0.5	Ext	Safety charge timers, Temperature monitor	10-Pin MSOP
MCP73842	Linear	Li-Ion/Li-Polymer	2	8.7 to 12	±0.5	Ext	Safety charge timers, Temperature monitor	10-Pin MSOP
MCP73843	Linear	Li-Ion/Li-Polymer	1	4.5 to 12	±0.5	Ext	Safety charge timers	8-Pin MSOP
MCP73844	Linear	Li-Ion/Li-Polymer	2	8.7 to 12	±0.5	Ext	Safety charge timers	8-Pin MSOP
MCP73853	Linear	Li-Ion/Li-Polymer	1	4.5 to 5.5	±0.5	Int	USB control, Safety charge timers, Temperature monitor, Thermal regulation	16-Pin QFN (4x4)
MCP73855	Linear	Li-Ion/Li-Polymer	1	4.5 to 5.5	±0.5	Int	USB control, Safety charge timers, Thermal regulation	10-Pin DFN (3x3)
MCP73861	Linear	Li-Ion/Li-Polymer	1	4.5 to 12	±0.5	Int	Safety charge timers, Temperature monitor, Thermal regulation	16-Pin 4x4 QFN, 16-Pin SOIC
MCP73862	Linear	Li-Ion/Li-Polymer	2	8.7 to 12	±0.5	Int	Safety charge timers, Temperature monitor, Thermal regulation	16-Pin 4x4 QFN, 16-Pin SOIC
MCP73863	Linear	Li-Ion/Li-Polymer	1	4.5 to 12	±0.5	Int	Safety charge timers, Temperature monitor, Thermal regulation, high-impedance STAT1 output on charge complete	16-Pin 4x4 QFN, 16-Pin SOIC
MCP73864	Linear	Li-Ion/Li-Polymer	2	8.7 to 12	±0.5	Int	Safety charge timers, Temperature monitor, Thermal regulation, high-impedance STAT1 output on charge complete	16-Pin 4x4 QFN, 16-Pin SOIC

POWER MANAGEMENT – Hot Swap Controllers

Part #	Number of Outputs	Vpos to Vneg Differential Voltage (V)	Junction Temperature Range (°C)	OVLO	UVLO	Power Good	Int/Ext FET	Applications	Packages
MCP18480	1	-0.3 to +15.0	-40 to +85	Adjustable	Adjustable	Adjustable	Ext	-48V Telecom/Datacom, Bus/Backplane	20-Pin SSOP

LINEAR – Op Amps

Part #	# per Package	GBWP	Iq Typical (µA)	Vos Max (mV)	Input Voltage Noise Density (nV/rtHz)	Operating Voltage (V)	Temp. Range (°C)	Features	Packages
TC1034	1	90 kHz	6	1.5	125 ⁽¹⁾	1.8 to 5.5	-40 to +85	Rail-to-Rail Input/Output	5-Pin SOT-23A ^(R)
TC1035	1	90 kHz	6	1.5	125 ⁽¹⁾	1.8 to 5.5	-40 to +85	Rail-to-Rail Input/Output, Shutdown pin	6-Pin SOT-23A ^(R)
TC1029	2	90 kHz	12	1.5	125 ⁽¹⁾	1.8 to 5.5	-40 to +85	Rail-to-Rail Input/Output	8-Pin PDIP, 8-Pin MSOP, 8-Pin SOIC
TC1030	4	90 kHz	5	1.5	125 ⁽¹⁾	1.8 to 5.5	-40 to +85	Rail-to-Rail Input/Output, Shutdown pins	16-Pin QSOP
MCP6041	1	14 kHz	0.6	3	170 ⁽¹⁾	1.4 to 5.5	-40 to +85	Rail-to-Rail Input/Output	8-Pin PDIP, 8-Pin SOIC, 8-Pin MSOP, 5-Pin SOT-23 ^(S)
MCP6042	2	14 kHz	0.6	3	170 ⁽¹⁾	1.4 to 5.5	-40 to +85	Rail-to-Rail Input/Output	8-Pin PDIP, 8-Pin SOIC, 8-Pin MSOP

Legend: S = Standard Pinout; R = Reverse Pinout; U = Alternative Pinout

NOTE 1: Values are typical at 1 kHz
2: Values are typical at 10 kHz

LINEAR – Op Amps (continued)

Part #	# per Package	GBWP	I _q Typical (μA)	V _{os} Max (mV)	Input Voltage Noise Density (nV/√Hz)	Operating Voltage (V)	Temp. Range (°C)	Features	Packages
MCP6043	1	14 kHz	0.6	3	170 ⁽¹⁾	1.4 to 5.5	-40 to +85	Rail-to-Rail Input/Output, Chip Select	8-Pin PDIP, 8-Pin SOIC, 8-Pin MSOP
MCP6044	4	14 kHz	0.6	3	170 ⁽¹⁾	1.4 to 5.5	-40 to +85	Rail-to-Rail Input/Output	14-Pin PDIP, 14-Pin SOIC, 14-Pin TSSOP
MCP6141	1	100 kHz	0.6	3	170 ⁽¹⁾	1.4 to 5.5	-40 to +85	Rail-to-Rail Input/Output, G>10 stable	8-Pin PDIP, 8-Pin SOIC, 8-Pin MSOP
MCP6142	2	100 kHz	0.6	3	170 ⁽¹⁾	1.4 to 5.5	-40 to +85	Rail-to-Rail Input/Output, G>10 stable	8-Pin PDIP, 8-Pin SOIC, 8-Pin MSOP
MCP6143	1	100 kHz	0.6	3	170 ⁽¹⁾	1.4 to 5.5	-40 to +85	Rail-to-Rail Input/Output, G>10 stable, Chip Select	8-Pin PDIP, 8-Pin SOIC, 8-Pin MSOP
MCP6144	4	100 kHz	0.6	3	170 ⁽¹⁾	1.4 to 5.5	-40 to +85	Rail-to-Rail Input/Output, G>10 stable	14-Pin PDIP, 14-Pin SOIC, 14-Pin TSSOP
MCP606	1	155 kHz	19	0.25	38 ⁽¹⁾	2.5 to 5.5	-40 to +85	Rail-to-Rail Output	8-Pin PDIP, 8-Pin SOIC, 8-Pin TSSOP, 5-Pin SOT23 ^(S)
MCP607	2	155 kHz	19	0.25	38 ⁽¹⁾	2.5 to 5.5	-40 to +85	Rail-to-Rail Output	8-Pin PDIP, 8-Pin SOIC, 8-Pin TSSOP
MCP608	1	155 kHz	19	0.25	38 ⁽¹⁾	2.5 to 5.5	-40 to +85	Rail-to-Rail Output, Chip Select	8-Pin PDIP, 8-Pin SOIC, 8-Pin TSSOP
MCP609	4	155 kHz	19	0.25	38 ⁽¹⁾	2.5 to 5.5	-40 to +85	Rail-to-Rail Output	14-Pin PDIP, 14-Pin SOIC, 14-Pin TSSOP
MCP616	1	190 kHz	19	0.15	32 ⁽¹⁾	2.3 to 5.5	-40 to +85	Rail-to-Rail Output, PNP Input	8-Pin PDIP, 8-Pin SOIC, 8-Pin MSOP
MCP617	2	190 kHz	19	0.15	32 ⁽¹⁾	2.3 to 5.5	-40 to +85	Rail-to-Rail Output, PNP	8-Pin PDIP, 8-Pin SOIC, 8-Pin MSOP
MCP618	1	190 kHz	19	0.15	32 ⁽¹⁾	2.3 to 5.5	-40 to +85	Rail-to-Rail Output, Chip Select, PNP Input	8-Pin PDIP, 8-Pin SOIC, 8-Pin MSOP
MCP619	4	190 kHz	19	0.15	32 ⁽¹⁾	2.3 to 5.5	-40 to +85	Rail-to-Rail Output, PNP Input	14-Pin PDIP, 14-Pin SOIC, 14-Pin TSSOP
MCP6231	1	300 kHz	20	5	52 ⁽¹⁾	1.8 to 5.5	-40 to +125	Rail-to-Rail Input/Output	5-Pin SC-70 ^(U) , 5-Pin SOT-23 ^(S,R,U) , 8-Pin PDIP, 8-Pin SOIC, 8-Pin MSOP
MCP6232	2	300 kHz	20	5	52 ⁽¹⁾	1.8 to 5.5	-40 to +125	Rail-to-Rail Input/Output	8-Pin PDIP, 8-Pin SOIC, 8-Pin MSOP
MCP6234	4	300 kHz	20	5	52 ⁽¹⁾	1.8 to 5.5	-40 to +125	Rail-to-Rail Input/Output	14-Pin PDIP, 14-Pin SOIC, 14-Pin TSSOP
MCP6241	1	550 kHz	50	5	45 ⁽¹⁾	1.8 to 5.5	-40 to +125	Rail-to-Rail Input/Output	5-Pin SC-70 ^(U) , 5-Pin SOT-23 ^(S,R,U) , 8-Pin PDIP, 8-Pin SOIC, 8-Pin MSOP
MCP6242	2	550 kHz	50	5	45 ⁽¹⁾	1.8 to 5.5	-40 to +125	Rail-to-Rail Input/Output	8-Pin PDIP, 8-Pin SOIC, 8-Pin MSOP
MCP6244	4	550 kHz	50	5	45 ⁽¹⁾	1.8 to 5.5	-40 to +125	Rail-to-Rail Input/Output	14-Pin PDIP, 14-Pin SOIC, 14-Pin TSSOP
MCP6001	1	1 MHz	140	4.5	28 ⁽¹⁾	1.8 to 5.5	-40 to +125	Rail-to-Rail Input/Output	5-Pin SOT-23 ^(S,R,U) , 5-Pin SC-70 ^(R,U)
MCP6002	2	1 MHz	140	4.5	28 ⁽¹⁾	1.8 to 5.5	-40 to +125	Rail-to-Rail Input/Output	8-Pin PDIP, 8-Pin SOIC, 8-Pin MSOP
MCP6004	4	1 MHz	140	4.5	28 ⁽¹⁾	1.8 to 5.5	-40 to +125	Rail-to-Rail Input/Output	14-Pin PDIP, 14-Pin SOIC, 14-Pin TSSOP
MCP6271	1	2 MHz	170	3	20 ⁽¹⁾	2.0 to 5.5	-40 to +125	Rail-to-Rail Input/Output	5-Pin SOT-23 ^(S,R) , 8-Pin PDIP, 8-Pin SOIC, 8-Pin MSOP
MCP6272	2	2 MHz	170	3	20 ⁽¹⁾	2.0 to 5.5	-40 to +125	Rail-to-Rail Input/Output	8-Pin PDIP, 8-Pin SOIC, 8-Pin MSOP
MCP6273	1	2 MHz	170	3	20 ⁽¹⁾	2.0 to 5.5	-40 to +125	Rail-to-Rail Input/Output, Chip Select	6-Pin SOT-23 ^(S) , 8-Pin PDIP, 8-Pin SOIC, 8-Pin MSOP

Legend: S = Standard Pinout; R = Reverse Pinout; U = Alternative Pinout

NOTE 1: Values are typical at 1 kHz

NOTE 2: Values are typical at 10 kHz

LINEAR – Op Amps (continued)

Part #	# per Package	GBWP	I _Q Typical (μA)	V _{OS} Max (mV)	Input Voltage Noise Density (nV/rtHz)	Operating Voltage (V)	Temp. Range (°C)	Features	Packages
MCP6274	4	2 MHz	170	3	20 ⁽¹⁾	2.0 to 5.5	-40 to +125	Rail-to-Rail Input/Output	14-Pin PDIP, 14-Pin SOIC, 14-Pin TSSOP
MCP6275	2	2 MHz	150	3	20 ⁽¹⁾	2.0 to 5.5	-40 to +125	Rail-to-Rail Input/Output, Dual connected, Chip Select	8-Pin PDIP, 8-Pin SOIC, 8-Pin MSOP
MCP601	1	2.8 MHz	230	2	29 ⁽¹⁾	2.7 to 5.5	-40 to +125	Rail-to-Rail Output	5-Pin SOT-23 ^(S,R) , 8-Pin PDIP, 8-Pin SOIC, 8-Pin TSSOP
MCP602	2	2.8 MHz	230	2	29 ⁽¹⁾	2.7 to 5.5	-40 to +125	Rail-to-Rail Output	8-Pin PDIP, 8-Pin SOIC, 8-Pin TSSOP
MCP603	1	2.8 MHz	230	2	29 ⁽¹⁾	2.7 to 5.5	-40 to +125	Rail-to-Rail Output, Chip Select	6-Pin SOT-23 ^(S) , 8-Pin PDIP, 8-Pin SOIC, 8-Pin TSSOP
MCP604	4	2.8 MHz	230	2	29 ⁽¹⁾	2.7 to 5.5	-40 to +125	Rail-to-Rail Output	14-Pin PDIP, 14-Pin SOIC, 14-Pin TSSOP
MCP6281	1	5 MHz	445	3	16 ⁽¹⁾	2.2 to 5.5	-40 to +125	Rail-to-Rail Input/Output	5-Pin SOT-23 ^(S,R) , 8-Pin PDIP, 8-Pin SOIC, 8-Pin MSOP
MCP6282	2	5 MHz	445	3	16 ⁽¹⁾	2.2 to 5.5	-40 to +125	Rail-to-Rail Input/Output	8-Pin PDIP, 8-Pin SOIC, 8-Pin MSOP
MCP6283	1	5 MHz	445	3	16 ⁽¹⁾	2.2 to 5.5	-40 to +125	Rail-to-Rail Input/Output, Chip Select	6-Pin SOT-23 ^(S,R) , 8-Pin PDIP, 8-Pin SOIC, 8-Pin MSOP
MCP6284	4	5 MHz	445	3	16 ⁽¹⁾	2.2 to 5.5	-40 to +125	Rail-to-Rail Input/Output	14-Pin PDIP, 14-Pin SOIC, 14-Pin TSSOP
MCP6285	2	5 MHz	400	3	16 ⁽¹⁾	2.2 to 5.5	-40 to +125	Rail-to-Rail Input/Output, Dual connected, Chip Select	8-Pin PDIP, 8-Pin SOIC, 8-Pin MSOP
MCP6291	1	10 MHz	1000	3	8.7 ⁽²⁾	2.4 to 5.5	-40 to +125	Rail-to-Rail Input/Output	5-Pin SOT-23 ^(S,R) , 8-Pin PDIP, 8-Pin SOIC, 8-Pin MSOP
MCP6292	2	10 MHz	1000	3	8.7 ⁽²⁾	2.4 to 5.5	-40 to +125	Rail-to-Rail Input/Output	8-Pin PDIP, 8-Pin SOIC, 8-Pin MSOP
MCP6293	1	10 MHz	1000	3	8.7 ⁽²⁾	2.4 to 5.5	-40 to +125	Rail-to-Rail Input/Output, Chip Select	6-Pin SOT-23 ^(S) , 8-Pin PDIP, 8-Pin SOIC, 8-Pin MSOP
MCP6294	4	10 MHz	1000	3	8.7 ⁽²⁾	2.4 to 5.5	-40 to +125	Rail-to-Rail Input/Output	14-Pin PDIP, 14-Pin SOIC, 14-Pin TSSOP
MCP6295	2	10 MHz	1100	3	8.7 ⁽²⁾	2.4 to 5.5	-40 to +125	Rail-to-Rail Input/Output, Dual connected, Chip Select	8-Pin PDIP, 8-Pin SOIC, 8-Pin MSOP
MCP6021	1	10 MHz	1000	0.5	8.7 ⁽²⁾	2.5 to 5.5	-40 to +125	Rail-to-Rail Input/Output, 1/2 V _{CC} V _{REF}	8-Pin PDIP, 8-Pin SOIC, 8-Pin TSSOP
MCP6022	2	10 MHz	1000	0.5	8.7 ⁽²⁾	2.5 to 5.5	-40 to +125	Rail-to-Rail Input/Output	8-Pin PDIP, 8-Pin SOIC, 8-Pin TSSOP
MCP6023	1	10 MHz	1000	0.5	8.7 ⁽²⁾	2.5 to 5.5	-40 to +125	Rail-to-Rail Input/Output, Chip Select, 1/2 V _{CC} V _{REF}	8-Pin PDIP, 8-Pin SOIC, 8-Pin TSSOP
MCP6024	4	10 MHz	1000	0.5	8.7 ⁽²⁾	2.5 to 5.5	-40 to +125	Rail-to-Rail Input/Output	14-Pin PDIP, 14-Pin SOIC, 14-Pin TSSOP

Legend: S = Standard Pinout; R = Reverse Pinout; U = Alternative Pinout

NOTE 1: Values are typical at 1 kHz
 2: Values are typical at 10 kHz

LINEAR – High Precision Operational Amplifiers

Part #	# per Package	GBWP	Iq MAX (mA)	Typical Vos (μV)	Vos Drift Max (μV/°C)	Operating Voltage (V)	Temp. Range (°C)	Features	Packages
Chopper Stabilized									
TC7650	1	2.0 MHz	3.5	5	0.05	4.5 to 16	0 to 70	Single and Split Supply	8-Pin PDIP, 14-Pin PDIP
TC7652	1	0.4 MHz	3	5	0.05	5 to 16	0 to 70	Single and Split Supply, Low Noise	8-Pin PDIP, 14-Pin PDIP
Auto-Zero									
TC913A/B	2	1.5 MHz	1.1	15	0.15/0.30	6.5 to 16	0 to 70	Single and Split Supply	8-Pin PDIP, 8-Pin SOIC

LINEAR – Programmable Gain Amplifiers (PGA)

Part #	Channels	-3dB BW (MHz)	Iq Typ.	Vos (μV)	Operating Voltage (V)	Temp. Range (°C)	Features	Packages
MCP6S21	1	2 to 12	1.1 mA	275	2.5 to 5.5	-40 to +85	SPI™, 8 Gain Steps, Software Shutdown	8-Pin PDIP, 8-Pin SOIC, 8-Pin MSOP
MCP6S22	2	2 to 12	1.1 mA	275	2.5 to 5.5	-40 to +85	SPI™, 8 Gain Steps, Software Shutdown	8-Pin PDIP, 8-Pin SOIC, 8-Pin MSOP
MCP6S26	6	2 to 12	1.1 mA	275	2.5 to 5.5	-40 to +85	SPI™, 8 Gain Steps, Software Shutdown	14-Pin PDIP, 14-Pin SOIC, 14-Pin TSSOP
MCP6S28	8	2 to 12	1.1 mA	275	2.5 to 5.5	-40 to +85	SPI™, 8 Gain Steps, Software Shutdown	16-Pin PDIP, 16-Pin SOIC
MCP6S91	1	1 to 18	1.0 mA	4000	2.5 to 5.5	-40 to +125	SPI™, 8 Gain Steps, Software Shutdown, VREF	8-Pin PDIP, 8-Pin SSOIC, 8-Pin MSOP
MCP6S92	2	1 to 18	1.0 mA	4000	2.5 to 5.5	-40 to +125	SPI™, 8 Gain Steps, Software Shutdown	8-Pin PDIP, 8-Pin SSOIC, 8-Pin MSOP
MCP6S93	2	1 to 18	1.0 mA	4000	2.5 to 5.5	-40 to +125	SPI™, 8 Gain Steps, Software Shutdown, VREF, SO	10-Pin MSOP

LINEAR – Integrated Devices

Part #	# of Op Amps per Package	# of Comparators per Package	Iq Typical (μA)	VREF (V)	Operating Voltage (V)	Temp. Range (°C)	Features	Packages
TC1026C	1	1	12	1.2	1.8 to 5.5	-40 to +85	On-board VREF	8-Pin PDIP, 8-Pin MSOP, 8-Pin SOIC
TC1043C	2	2	16	1.2	1.8 to 5.5	-40 to +85	On-board VREF, Shutdown pin	16-Pin QSOP

LINEAR – Comparators

Part #	# per Package	VREF (V)	Typical Propagation Delay (μs)	Iq Typical (μA)	Vos Max (mV)	Operating Voltage (V)	Temp. Range (°C)	Features	Packages
TC1027	4	1.2	4	18	5	1.8 to 5.5	-40 to +85	On-board VREF, Rail-to-Rail Input/Output	16-Pin PDIP, 16-Pin QSOP, 16-Pin SOIC
TC1037	1	—	4	4	5	1.8 to 5.5	-40 to +85	Rail-to-Rail Input/Output	5-Pin SOT-23A ^(S)
TC1038	1	—	4	4	5	1.8 to 5.5	-40 to +85	Shutdown pin, Rail-to-Rail Input/Output	6-Pin SOT-23A ^(S)
TC1039	1	1.2	4	6	5	1.8 to 5.5	-40 to +85	On-board VREF, Rail-to-Rail Input/Output	6-Pin SOT-23A ^(S)
TC1041	2	1.2	4	10	5	1.8 to 5.5	-40 to +85	On-board VREF, Programmable hysteresis, Rail-to-Rail Input/Output	8-Pin MSOP, 8-Pin SOIC
MCP6541	1	—	4	1	5	1.6 to 5.5	-40 to +85	Push-Pull, Rail-to-Rail Input/Output	5-Pin SOT-23 ^(S,R) , 5-Pin SC-70 ^(S) , 8-Pin PDIP, 8-Pin SOIC, 8-Pin MSOP
MCP6542	2	—	4	1	5	1.6 to 5.5	-40 to +85	Push-Pull, Rail-to-Rail Input/Output	8-Pin PDIP, 8-Pin SOIC, 8-Pin MSOP
MCP6543	1	—	4	1	5	1.6 to 5.5	-40 to +85	Push-Pull, Rail-to-Rail Input/Output, Chip Select	8-Pin PDIP, 8-Pin SOIC, 8-Pin MSOP

LINEAR – Comparators (continued)

Part #	# per Package	VREF (V)	Typical Propagation Delay (μ s)	I _Q Typical (μ A)	V _{OS} Max (mV)	Operating Voltage (V)	Temp. Range (°C)	Features	Packages
MCP6544	4	—	4	1	5	1.6 to 5.5	-40 to +85	Push-Pull, Rail-to-Rail Input/Output	14-Pin PDIP, 14-Pin SOIC, 14-Pin TSSOP
MCP6546	1	—	4	1	5	1.6 to 5.5	-40 to +85	Open-drain, 9V, Rail-to-Rail Input/Output	5-Pin SOT-23 ^(S,R) , 5-Pin SC-70 ^(S) , 8-Pin PDIP, 8-Pin SOIC, 8-Pin MSOP
MCP6547	2	—	4	1	5	1.6 to 5.5	-40 to +85	Open-drain, 9V, Rail-to-Rail Input/Output	8-Pin PDIP, 8-Pin SOIC, 8-Pin MSOP
MCP6548	1	—	4	1	5	1.6 to 5.5	-40 to +85	Open-drain, 9V, Rail-to-Rail Input/Output, Chip Select	8-Pin PDIP, 8-Pin SOIC, 8-Pin MSOP
MCP6549	4	—	4	1	5	1.6 to 5.5	-40 to +85	Open-drain, 9V, Rail-to-Rail Input/Output	14-Pin PDIP, 14-Pin SOIC, 14-Pin TSSOP

Legend: S = Standard Pinout; R = Reverse Pinout

MIXED SIGNAL – Successive Approximation Register (SAR) A/D Converters

Part #	Resolution (bits)	Maximum Sampling Rate (ksamples/sec)	# of Input Channels	Input Type	Interface	Input Voltage Range (V)	Max. Supply Current (μ A)	Max. INL	Temp. Range (°C)	Packages
MCP3021	10	22	1	Single-ended	I ² C™	2.7 to 5.5	250	±1 LSB	-40 to +125	5-Pin SOT-23A
MCP3001	10	200	1	Single-ended	SPI™	2.7 to 5.5	500	±1 LSB	-40 to +85	8-Pin PDIP, 8-Pin SOIC, 8-Pin TSSOP
MCP3002	10	200	2	Single-ended	SPI™	2.7 to 5.5	650	±1 LSB	-40 to +85	8-Pin PDIP, 8-Pin SOIC, 8-Pin TSSOP
MCP3004	10	200	4	Single-ended	SPI™	2.7 to 5.5	550	±1 LSB	-40 to +85	14-Pin PDIP, 14-Pin SOIC, 14-Pin TSSOP
MCP3008	10	200	8	Single-ended	SPI™	2.7 to 5.5	550	±1 LSB	-40 to +85	16-Pin PDIP, 16-Pin SOIC
MCP3221	12	22	1	Single-ended	I ² C™	2.7 to 5.5	250	±2 LSB	-40 to +125	5-Pin SOT-23A
MCP3201	12	100	1	Single-ended	SPI™	2.7 to 5.5	400	±1 LSB	-40 to +85	8-Pin PDIP, 8-Pin SOIC, 8-Pin TSSOP
MCP3202	12	100	2	Single-ended	SPI™	2.7 to 5.5	550	±1 LSB	-40 to +85	8-Pin PDIP, 8-Pin SOIC, 8-Pin TSSOP
MCP3204	12	100	4	Single-ended	SPI™	2.7 to 5.5	400	±1 LSB	-40 to +85	14-Pin PDIP, 14-Pin SOIC, 14-Pin TSSOP
MCP3208	12	100	8	Single-ended	SPI™	2.7 to 5.5	400	±1 LSB	-40 to +85	16-Pin PDIP, 16-Pin SOIC
MCP3301	13	100	1	Differential	SPI™	2.7 to 5.5	450	±1 LSB	-40 to +85	8-Pin PDIP, 8-Pin SOIC, 8-Pin MSOP
MCP3302	13	100	2	Differential	SPI™	2.7 to 5.5	450	±1 LSB	-40 to +85	14-Pin PDIP, 14-Pin SOIC, 14-Pin TSSOP
MCP3304	13	100	4	Differential	SPI™	2.7 to 5.5	450	±1 LSB	-40 to +85	16-Pin PDIP, 16-Pin SOIC

MIXED SIGNAL – Delta-Sigma A/D Converters

Part #	Resolution (bits)	Maximum Sampling Rate (samples/sec)	# of Input Channels	Interface	Supply Voltage Range (V)	Typical Supply Current (μ A)	Typical INL (%FSR)	Temp. Range (°C)	Features	Packages
MCP3551	22	14	1 Diff	SPI™	2.7 to 5.5	125	0.0002	-40 to +125	Simultaneous 50/60 Hz rejection	8-Pin SOIC, 8-Pin MSOP
MCP3553	20	55	1 Diff	SPI™	2.7 to 5.5	140	0.0002	-40 to +125		8-Pin SOIC, 8-Pin MSOP
TC3400 ⁽¹⁾	10 to 16	>400	1 Diff	2-Wire	1.8 to 5.5	260	0.0038	0 to +85		8-Pin PDIP, 8-Pin SOIC
TC3401 ⁽¹⁾	10 to 16	>400	2 Diff	2-Wire	1.8 to 5.5	300	0.0038	0 to +85	Enable mode, Reset monitor, Power-fail monitor	16-Pin PDIP, 16-Pin QSOP

NOTE 1: All TC340X are not recommended for new designs.

MIXED SIGNAL – Delta-Sigma A/D Converters (continued)

Part #	Resolution (bits)	Maximum Sampling Rate (samples/sec)	# of Input Channels	Interface	Supply Voltage Range (V)	Typical Supply Current (μ A)	Typical INL (%FSR)	Temp. Range ($^{\circ}$ C)	Features	Packages
TC3402 ⁽¹⁾	10 to 16	>400	4 Diff	2-Wire	1.8 to 5.5	250	0.0038	0 to +85		16-Pin PDIP, 16-Pin QSOP
TC3405 ⁽¹⁾	10 to 16	>400	3 Single-ended, 1 Diff	2-Wire	1.8 to 5.5	250	0.0038	0 to +85	Enable mode, Reset monitor	16-Pin PDIP, 16-Pin QSOP

NOTE 1: All TC340X are not recommended for new designs.

MIXED SIGNAL – Energy Measurement ICs

Part #	Dynamic Measurement	Typical Measurement Accuracy	Gain	Typical Voltage Reference Drift	Typical Supply Current	Supply Voltage Range (V)	Temp. Range ($^{\circ}$ C)	Features	Packages
MCP3905	500:1	0.1%	1, 2, 8, 16	15 ppm	AI _{DD} - 2 mA DI _{DD} - 15 mA	4.5 to 5.5	-40 to +85	Active (real) power pulse output	24-Pin SSOP
MCP3906	1000:1	0.1%	1, 2, 8, 16, 32	15 ppm	AI _{DD} - 2 mA DI _{DD} - 15 mA	4.5 to 5.5	-40 to +85	Active (real) power pulse output	24-Pin SSOP

MIXED SIGNAL – Dual Slope A/D Converters

Part #	Supply Voltage (V)	Input Voltage Range (V)	Resolution	Sampling Rate (Conv/s)	Input Channels	Data Interface	Temp. Range ($^{\circ}$ C)	Features	Packages
TC500	± 4.5 to ± 7.5	V _{SS} + 1.5V to V _{DD} – 1.5V	Up to 16 bits	4 to 10	1	3-Wire	0 to +70	Differential input range, Programmable resolution/conversion time	16-Pin PDIP, 16-Pin SOIC, 16-Pin CerDIP
TC500A	± 4.5 to ± 7.5	V _{SS} + 1.5V to V _{DD} – 1.5V	Up to 17 bits	4 to 10	1	3-Wire	0 to +70	Differential input range, Programmable resolution/conversion time	16-Pin PDIP, 16-Pin SOIC, 16-Pin CerDIP
TC510	+4.5 to +5.5	V _{SS} + 1.5V to V _{DD} – 1.5V	Up to 17 bits	4 to 10	1	3-Wire	0 to +70	Differential input range, Programmable resolution/conversion time, Charge pump (-V) output pin	24-Pin PDIP, 24-Pin SOIC
TC514	+4.5 to +5.5	V _{SS} + 1.5V to V _{DD} – 1.5V	Up to 17 bits	4 to 10	4	3-Wire	0 to +70	Differential input range, Programmable resolution/conversion time, Charge pump (-V) output pin	28-Pin PDIP, 28-Pin SOIC
TC520A	+4.5 to +5.5	—	—	—	—	Serial port	0 to +70	Optional serial interface adapter for TC500/500A/510/514	14-Pin PDIP, 16-Pin SOIC
TC530	+4.5 to +5.5	V _{SS} + 1.5V to V _{DD} – 1.5V	Up to 17 bits	3 to 10	1	Serial port	0 to +70	Differential input range, Programmable resolution/conversion time, Charge pump (-V) output pin	28-Pin PDIP, 28-Pin SOIC
TC534	+4.5 to +5.5	V _{SS} + 1.5V to V _{DD} – 1.5V	Up to 17 bits	3 to 10	4	Serial port	0 to +70	Differential input range, Programmable resolution/conversion time, Charge pump (-V) output pin	40-Pin PDIP, 44-Pin MQFP
TC7109	± 4.5 to ± 5.5	V _{SS} + 1.5V to V _{DD} – 1.0V	12 bits plus sign bit	2 to 10	1	Parallel or Serial port	-25 to +85	Differential input range	40-Pin PDIP, 40-Pin CerDip, 44-Pin PLCC, 44-Pin MQFP
TC7109A	± 4.5 to ± 5.5	V _{SS} + 1.5V to V _{DD} – 1.0V	12 bits plus sign bit	2 to 10	1	Parallel or Serial port	-25 to +85	Differential input range	40-Pin PDIP, 40-Pin CerDip, 44-Pin PLCC, 44-Pin MQFP

MIXED SIGNAL – Binary and BCD A/D Converters

Part #	Description	Supply Voltage (V)	Input Voltage Range (V)	Resolution (Digits)	Resolution (Counts)	Max Power (mW)	Data Interface	Temp. Range (°C)	Features	Packages
TC835	BCD A/D	±5	V _{SS} + 1.0V to V _{DD} – 0.5V	4½	±20,000	30	MUXed BCD	0 to +70	Upgrade to TC7135	64-Pin MQFP, 44-Pin MQFP, 28-Pin PDIP
TC850	Binary A/D	±5	V _{SS} + 1.5V to V _{DD} – 1.5V	15-bit	±32,768	35	8-bit parallel	-25 to +70	Highest conversion speed (40 conv/sec)	44-Pin PLCC, 40-Pin PDIP, 40-Pin CerDIP
TC7135	BCD A/D	±5	V _{SS} + 1.0V to V _{DD} – 1.0V	4½	±20,000	30	MUXed BCD	0 to +70	For DMM, DPM, Data loggers	28-Pin PLCC, 28-Pin PDIP, 64-Pin MQFP
TC14433	BCD A/D	±4.5 to ±8	±199.9 mV to 1.999V	3½	±2,000	20	MUXed BCD	-40 to +85	For DMM, DPM, Data loggers	24-Pin SOIC, 24-Pin PDIP, 28-Pin PLCC, 24-Pin CerDIP
TC14433A	BCD A/D	±4.5 to ±8	±199.9 mV to 1.999V	3½	±2,000	20	MUXed BCD	-40 to +85	For DMM, DPM, Data loggers	24-Pin PDIP, 28-Pin PLCC, 24-Pin CerDIP

MIXED SIGNAL – Display A/D Converters

Part #	Display Type	Supply Voltage (V)	Resolution (Digits)	Resolution (Counts)	Power (mW)	Temp. Range (°C)	Features	Packages
TC820	LCD	9	3¾	±4,000	10	0 to +70	DMM plus frequency counter and logic probe	40-Pin PDIP, 44-Pin PLCC, 44-Pin MQFP
TC7106	LCD	9	3½	±2,000	10	-25 to +85	For DMM, DPM, Data logger applications	40-Pin PDIP, 44-Pin PLCC, 44-Pin MQFP, 40-Pin CerDIP
TC7106A	LCD	9	3½	±2,000	10	-25 to +85	For DMM, DPM, Data logger applications	40-Pin PDIP, 44-Pin PLCC, 44-Pin MQFP, 40-Pin CerDIP
TC7107	LED	±5	3½	±2,000	10	-25 to +85	For DMM, DPM, Data logger applications	40-Pin PDIP, 44-Pin PLCC, 44-Pin MQFP, 40-Pin CerDIP
TC7107A	LED	±5	3½	±2,000	10	-25 to +85	For DMM, DPM, Data logger applications	40-Pin PDIP, 44-Pin PLCC, 44-Pin MQFP, 40-Pin CerDIP
TC7116	LCD	9	3½	±2,000	10	-25 to +85	Hold function	40-Pin PDIP, 44-Pin PLCC, 44-Pin MQFP, 40-Pin CerDIP
TC7116A	LCD	9	3½	±2,000	10	-25 to +85	Hold function	40-Pin PDIP, 44-Pin PLCC, 44-Pin MQFP, 40-Pin CerDIP
TC7117	LED	±5	3½	±2,000	10	-25 to +85	Hold function	40-Pin PDIP, 44-Pin PLCC, 44-Pin MQFP, 40-Pin CerDIP
TC7117A	LED	±5	3½	±2,000	10	-25 to +85	Hold function	40-Pin PDIP, 44-Pin PLCC, 44-Pin MQFP, 40-Pin CerDIP
TC7126	LCD	9	3½	±2,000	0.5	-25 to +85	Low-power TC7106	40-Pin PDIP, 44-Pin PLCC, 44-Pin MQFP, 40-Pin CerDIP
TC7126A	LCD	9	3½	±2,000	0.5	-25 to +85	Low-power TC7106	40-Pin PDIP, 44-Pin PLCC, 44-Pin MQFP, 40-Pin CerDIP
TC7129	LCD	9	4½	±20,000	4.5	0 to +70	Lowest noise ±3 mV sensitivity	40-Pin PDIP, 44-Pin PLCC, 44-Pin MQFP

MIXED SIGNAL – Digital Potentiometers

Part #	Number of Taps	Memory	Number per Package	Interface	Resistance (kOhms)	INL (max)	DNL (max)	Temp. Range (°C)	Comments	Packages
MCP4011	64	Volatile	1	Up/Down	2, 5, 10, 50	0.5	0.5	-40 to +125	Potentiometer mode	6-Pin SOT-23, 8-Pin SOIC, 8-Pin MSOP, 8-Pin 2x3 DFN
MCP4012	64	Volatile	1	Up/Down	2, 5, 10, 50	0.5	0.5	-40 to +125	Rheostat mode	6-Pin SOT-23
MCP4013	64	Volatile	1	Up/Down	2, 5, 10, 50	0.5	0.5	-40 to +125	Potentiometer to Vss	6-Pin SOT-23
MCP4014	64	Volatile	1	Up/Down	2, 5, 10, 50	0.5	0.5	-40 to +125	Rheostat to Vss	5-Pin SOT-23
MCP4021	64	Non-volatile	1	Up/Down	2, 5, 10, 50	0.5	0.5	-40 to +125	Potentiometer mode, Shutdown, WiperLock™ Technology	6-Pin SOT-23, 8-Pin SOIC, 8-Pin MSOP, 8-Pin 2x3 DFN
MCP4022	64	Non-volatile	1	Up/Down	2, 5, 10, 50	0.5	0.5	-40 to +125	Rheostat mode, Shutdown, WiperLock™ Technology	6-Pin SOT-23
MCP4023	64	Non-volatile	1	Up/Down	2, 5, 10, 50	0.5	0.5	-40 to +125	Potentiometer to Vss, WiperLock™ Technology	6-Pin SOT-23
MCP4024	64	Non-volatile	1	Up/Down	2, 5, 10, 50	0.5	0.5	-40 to +125	Rheostat to Vss, Shutdown, WiperLock™ Technology	5-Pin SOT-23
MCP41010	256	Volatile	1	SPI™	10	1	1	-40 to +85	Potentiometer mode, Shutdown	8-Pin PDIP, 8-Pin SOIC
MCP41050	256	Volatile	1	SPI™	50	1	1	-40 to +85	Potentiometer mode, Shutdown	8-Pin PDIP, 8-Pin SOIC
MCP41100	256	Volatile	1	SPI™	100	1	1	-40 to +85	Potentiometer mode, Shutdown	8-Pin PDIP, 8-Pin SOIC
MCP42010	256	Volatile	2	SPI™	10	1	1	-40 to +85	Potentiometer mode, Shutdown	14-Pin PDIP, 14-Pin SOIC, 14-Pin TSSOP
MCP42050	256	Volatile	2	SPI™	50	1	1	-40 to +85	Potentiometer mode, Shutdown	14-Pin PDIP, 14-Pin SOIC, 14-Pin TSSOP
MCP42100	256	Volatile	2	SPI™	100	1	1	-40 to +85	Potentiometer mode, Shutdown	14-Pin PDIP, 14-Pin SOIC, 14-Pin TSSOP

MIXED SIGNAL – Frequency-to-Voltage/Voltage-to-Frequency Converters

Part #	Frequency Range (kHz)	Full Scale (ppm FS/°C)	Non-linearity (%FS)	Temp. Range (°C)	Packages
TC9400	100	±40	±0.05	-40 to +85	14-Pin PDIP, 14-Pin SOIC
TC9401	100	±40	±0.02	-40 to +85	14-Pin PDIP, 14-Pin SOIC
TC9402	100	±100	±0.25	-40 to +85	14-Pin PDIP, 14-Pin SOIC

MIXED SIGNAL – D/A Converters

Part #	Resolution (Bits)	DACs per Package	Interface	VREF	Output Settling Time (µs)	DNL (LSB)	Typical Standby Current (µA)	Typical Operating Current (µA)	Temp. Range (°C)	Packages
TC1320	8	1	SMBus	Ext	10	±0.8	0.1	350	-40 to +85	8-Pin MSOP, 8-Pin SOIC
TC1321	10	1	SMBus	Ext	10	±2	0.1	350	-40 to +85	8-Pin MSOP, 8-Pin SOIC
MCP4821	12	1	SPI™	Y	4.5	1	0.3	330	-40 to +125	8-Pin PDIP, 8-Pin SOIC, 8-Pin MSOP
MCP4822	12	2	SPI™	Y	4.5	1	0.3	415	-40 to +125	8-Pin PDIP, 8-Pin SOIC, 8-Pin MSOP

NOTE: The analog output is voltage.

MIXED SIGNAL – D/A Converters (continued)

Part #	Resolution (Bits)	DACs per Package	Interface	VREF	Output Settling Time (μs)	DNL (LSB)	Typical Standby Current (μA)	Typical Operating Current (μA)	Temp. Range (°C)	Packages
MCP4921	12	1	SPI™	Ext	4.5	0.75	1	175	-40 to +125	8-Pin PDIP, 8-Pin SOIC, 8-Pin MSOP
MCP4922	12	2	SPI™	Ext	4.5	0.75	1	350	-40 to +125	14-Pin PDIP, 14-Pin SOIC, 14-Pin TSSOP

NOTE: The analog output is voltage.

INTERFACE – Controller Area Network (CAN) Products

Part #	Operating Voltage (V)	Temperature Range (°C)	Tx Buffers	Rx Buffers	Filters	Masks	Interrupt Output	Unique Features	Packages
MCP2510 ⁽¹⁾	2.7 to 5.5	-40 to +125	3	2	6	2	Yes	CAN 2.0B Active controller with SPI™ interface to MCU, 3 transmit buffers, 2 receive buffers, HW and SW message triggers	18-Pin PDIP, 18-Pin SOIC, 20-Pin TSSOP
MCP2515	2.7 to 5.5	-40 to +125	3	2	6	2	Yes	MCP2510 pin compatible upgrade with enhanced features including higher throughput and data byte filtering	18-Pin PDIP, 18-Pin SOIC, 20-Pin TSSOP
MCP25020	2.7 to 5.5	-40 to +125	3	2	2	1	N/A	CAN 2.0B Active I/O Expander, Configurable I/O, 2 PWM outputs	14-Pin PDIP, 14-Pin SOIC
MCP25025	2.7 to 5.5	-40 to +85	3	2	2	1	N/A	CAN 2.0B Active I/O Expander, Configurable I/O, 2 PWM outputs, One-wire CAN option	14-Pin PDIP, 14-Pin SOIC
MCP25050	2.7 to 5.5	-40 to +125	3	2	2	1	N/A	Mixed-Signal CAN 2.0B Active I/O Expander, Configurable I/O, 4 10-bit ADCs, 2 PWM outputs	14-Pin PDIP, 14-Pin SOIC
MCP25055	2.7 to 5.5	-40 to +85	3	2	2	1	N/A	Mixed-Signal CAN 2.0B Active I/O Expander, Configurable I/O, 4 10-bit ADCs, 2 PWM outputs, One-wire CAN option	14-Pin PDIP, 14-Pin SOIC
MCP2551	4.5 to 5.5	-40 to +125	n/a	n/a	n/a	n/a	N/A	High-speed CAN Transceiver (1 Mbps max. CAN bus speed), ISO11898 compatible, Industry standard pinout	8-Pin PDIP, 8-Pin SOIC

NOTE 1: Not recommended for new designs.

INTERFACE – Infrared Products

Part #	Operating Voltage (V)	Operating Temperature Range (°C)	Max. Baud Rate (Kbaud)	Unique Features	Packages
MCP2120	2.5 to 5.5	-40 to +85	325	UART to IR encoder/decoder with both hardware and software baud rate selection	14-Pin PDIP, 14-Pin SOIC
MCP2122	1.8 to 5.5	-40 to +85	16x less than clock input	UART to IR encoder/decoder	8-Pin PDIP, 8-Pin SOIC
MCP2140	2.7 to 5.5	-40 to +85	9.6	IrDA® Standard protocol handler plus bit encoder/decoder, Fixed baud rate, Low-cost	18-Pin PDIP, 18-Pin SOIC, 20-Pin SSOP
MCP2150	3.0 to 5.5	-40 to +85	115.2	IrDA® Standard protocol handler plus bit encoder/decoder on one chip for DTE applications, Programmable ID	18-Pin PDIP, 18-Pin SOIC, 20-Pin SSOP
MCP2155	3.0 to 5.5	-40 to +85	115.2	IrDA® Standard protocol handler plus bit encoder/decoder on one chip for DCE applications, Programmable ID	18-Pin PDIP, 18-Pin SOIC, 20-Pin SSOP

NOTE: IrDA® is a registered trademark of Infrared Data Association.

INTERFACE – Ethernet Products

Part #	Operating Voltage (V)	Operating Temperature Range (°C)	MAC	PHY	TX/RX Dual Port RAM	Bus Type	Max Bus Speed (MHz)	Features	Packages
ENC28J60	3.14 to 3.45	-40 to +85	yes	10-Base-T	8 KB	SPI™	25	Ethernet controller, IEEE 802.3 compatible, Loopback Test modes, Auto-polarity detection	28-Pin SOIC, 28-Pin SSOP, 28-Pin 6x6 QFN

INTERFACE – LIN Transceiver Products

Part #	Description	Vreg Output Voltage (V)	Operating Temperature Range (°C)	Vreg Output Current (mA)	Vcc Range (V)	Max Baud Rate	LIN Specification Supported	Packages
MCP201	LIN Transceiver with integrated VREG	4.75 to 5.25	-40 to +125	50	7.4 to 18 ⁽¹⁾	20 Kbaud	Revision 1.2	8-pin PDIP, 8-pin SOIC, 8-Pin DFN

NOTE 1: Can withstand 40V load dump.

INTERFACE – Serial Peripherals

Part #	Description	Operating Voltage (V)	Operating Temperature Range (°C)	Bus Type	Max. Bus Frequency (kHz)	Features	Packages
MCP23008	8-bit I/O Port Expander	1.8 to 5.5	-40 to +85	I ² C™	1700	3 HW address pins, HW interrupt, 25 mA source/sink capability per I/O	18-Pin PDIP, 18-Pin SOIC, 20-Pin SSOP
MCP23S08	8-bit I/O Port Expander	1.8 to 5.5	-40 to +85	SPI™	10000	2 HW address pins, HW interrupt, 25 mA source/sink capability per I/O	18-Pin PDIP, 18-Pin SOIC, 20-Pin SSOP
MCP23016	16-bit I/O Port Expander	2.0 to 5.5	-40 to +85	I ² C™	400	3 H/W address inputs, HW interrupt, 25 mA source/sink capability per I/O	28-Pin PDIP, 28-Pin SOIC, 28-Pin SSOP, 28-Pin 6x6 QFN
MCP23017	16-bit I/O expander	1.8 to 5.5	-40 to +125	I ² C™	1,700	3 HW address pins, 25 mA sink/source per I/O, 100 kHz, 400 kHz and 3-4 MHz I ² C™ supported, Interrupt output	28-Pin PDIP, 28-Pin SOIC, 28-Pin SSOP, 28-Pin QFN
MCP23S17	16-bit I/O expander	1.8 to 5.5	-40 to +125	SPI™	10,000	3 HW address pins, 25 mZ sink/source per I/O, Interrupt output	28-Pin PDIP, 28-Pin SOIC, 28-Pin SSOP, 28-Pin QFN

Interface – Passive Access Products

Part #	Operating Voltage (V)	Operating Temp. Range (°C)	Bus Type	RF Carrier Frequency	Data Format	Features	Packages
MCP2030	1.8 to 3.6	-40 to +85	SPI™	125 kHz	NRZ	Three axis signal conditioning devices for passive access applications, high-sensitivity, configurable smart wake-up filter	14-Pin PDIP, 14-Pin SOIC, 14-Pin TSSOP

FUTURE ANALOG/INTERFACE PRODUCTS

Lead-free versions of many devices are currently offered. Check Microchip's web site for availability.

Power Management – Low-Side Power MOSFET Drivers

Part #	Configuration	Operating Temperature (°C)	Peak Output Current (A)	Output Resistance (Ω)	Max. Supply Voltage	Input/Output Delay (td1, td2)	Packages
TC4433	Dual, Inverting	-40 to +125	6	1.8 (typ)/2.0 (typ)	18	30/30	8-Pin PDIP, 8-Pin 6x5 DFN
TC4434	Dual, Non-inverting	-40 to +125	6	1.8 (typ)/2.0 (typ)	18	30/30	8-Pin PDIP, 8-Pin 6x5 DFN

Power Management – Battery Chargers

Part #	Mode	Cell Type	# of Cells	Vcc Range (V)	Max. Voltage Regulation (%)	Int/Ext FET	Features	Packages
MCP73833/4/5	Linear	Li-Ion/Li-Polymer	1	3.75 to 6.0	±0.5	Int	1A max charging current, 2 status outputs, cell temperature monitor, LDO Test mode	10-Pin 3x3 DFN

Power Management – Linear Regulators

Part #	Max. Input Voltage (V)	Output Voltage (V)	Output Current (mA)	Junction Temp. Range (°C)	Typical Active Current (μA)	Typical Dropout Voltage of Rated Iout (mV)	Typical Output Voltage Accuracy (%)	Features	Packages
MCP1726	6.0	Fixed: 5, 3.3, 3.0, 2.5, 1.8, 1.2, 0.8 Adj: 0.8 to 5.0	1500	-40 to +125	140	330	±0.4	Ceramic cop stable, shutdown, Cdelay, Power Good	8-Pin SOIC, 8-Pin 3x3 DFN

Power Management – Switching Regulators

Part #	Description	Input Voltage (V)	Output Voltage (V)	Operating Temp. Range (°C)	Control Scheme	Switching Freq. (kHz)	Typical Active Current (mA)	Output Current (mA)	Features	Packages
MCP1603	Synchronous Buck DC/DC Regulator	2.7 to 5.5	0.8 to 4.5	-40 to +85	PFM/PWM	2000	35	500	PFM, PWM auto-switching, UVLO, soft-start	5-Pin SOT-23, 8-Pin 2x3 DFN

Linear – Linear Gain Blocks

Part #	Channels	-3dB BW (kHz)	I _Q (μA)	V _{OS} (mV)	Operating Voltage (V)	Temperature Range (°C)	Gain Steps (V/V)	Features	Packages
MCP6G01	1	1000	120	3	1.8 to 5.5	-40 to +125	1, 10, 50	Tri-State Control Pin	8-Pin PDIP, 8-Pin SOIC, 8-Pin TSSOP
MCP6G02	2	1000	120	3	1.8 to 5.5	-40 to +125	1, 10, 50	Tri-State Control Pin	8-Pin PDIP, 8-Pin SOIC, 8-Pin TSSOP
MCP6G04	4	1000	120	3	1.8 to 5.5	-40 to +125	1, 10, 50	Tri-State Control Pin	14-Pin PDIP, 14-Pin SOIC, 14-Pin TSSOP

Mixed Signal – Delta-Sigma A/D Converters

Part #	Resolution (bits)	Maximum Sampling Rate (ksamples/sec)	# of Input Channels	Interface	Supply voltage Range (V)	Typical Supply Current (µA)	Typical INL (%FSR)	Temperature Range (°C)	Features	Packages
MCP3550	22	14	1 Diff	SPI™	2.7 to 5.5	120	0.0002	-40 to +125	50 or 60 Hz rejection	8-Pin SOIC, 8-Pin MSOP

CURRENT PICmicro® MICROCONTROLLER FAMILY PRODUCTS

Baseline 8-Bit PICmicro® Microcontroller Family (12-bit Instruction Set)

Product	Program Memory Bytes & Type (Words)	RAM Bytes	I/O Pins	Packages	Analog		Digital	Max. Speed MHz	IntOSC	ICSP™	BOR/PBOR/PLVD	ICD # of Breakpoints	Operating Voltage (V)	Other Features
					ADC	Comp.	Timers/WDT							
PIC10FXXX: 500 ns Instruction Execution, 33 Instructions, 25 mA Source and Sink per I/O														
PIC10F200	384 StdFI (256)	16	4	6OT, 8P	—	—	1-8 bit, 1-WDT	4	4 MHz	✓	—	1**	2.0-5.5	
PIC10F202	768 StdFI (512)	24	4	6OT, 8P	—	—	1-8 bit, 1-WDT	4	4 MHz	✓	—	1**	2.0-5.5	
PIC10F204	384 StdFI (256)	16	4	6OT, 8P	—	1	1-8 bit, 1-WDT	4	4 MHz	✓	—	1**	2.0-5.5	Band gap reference
PIC10F206	768 StdFI (512)	24	4	6OT, 8P	—	1	1-8 bit, 1-WDT	4	4 MHz	✓	—	1**	2.0-5.5	Band gap reference
PIC10F220	384 StdFI (256)	16	4	6OT, 8P	2x8-bit	—	1-8 bit, 1-WDT	8	8 MHz	✓	—	1**	2.0-5.5	Band gap reference
PIC10F222	768 StdFI (512)	23	4	6OT, 8P	2x8-bit	—	1-8 bit, 1-WDT	8	8 MHz	✓	—	1**	2.0-5.5	Band gap reference
PIC12FXXX: 500 ns Instruction Execution, 33 Instructions, 25 mA Source and Sink I/O														
PIC12F508	768 StdFI (512)	25	6	8P, 8SN, 8MS	—	—	1-8 bit, 1-WDT	4	4 MHz	✓	—	1**	2.0-5.5	
PIC12F509	1,536 StdFI (1,024)	41	6	8P, 8SN, 8MS	—	—	1-8 bit, 1-WDT	4	4 MHz	✓	—	1**	2.0-5.5	
PIC12F510	1,536 StdFI (1,024)	38	6	8P, 8SN, 8MS	3x8-bit	1	1-8 bit, 1-WDT	8	8 MHz	✓	—	1**	2.0-5.5	Band gap reference
PIC16F5XX: 100-200 ns Instruction Execution, 33 Instructions, 25 mA Source and Sink I/O														
PIC16F505	1,536 StdFI (1,024)	72	12	14P, 14JW, 14SL, 14ST	—	—	1-8 bit, 1-WDT	20	4 MHz	✓	—	1**	2.0-5.5	
PIC16F506	1,536 StdFI (1,024)	67	12	14P, 14SO, 14ST	3x8-bit	2	1-8 bit, 1-WDT	20	8 MHz	✓	—	1**	2.0-5.5	Band gap reference
PIC16F54	768 StdFI (512)	25	12	18P, 18SO, 20SS	—	—	1-8 bit, 1-WDT	20	—	✓	—	—	2.0-5.5	
PIC16F57	3072 StdFI (2,048)	72	20	28P, 28SO, 28SS, 28SP	—	—	1-8 bit, 1-WDT	20	—	✓	—	—	2.0-5.5	
PIC16F59	3,072 StdFI (2,048)	134	32	40P, 44PT	—	—	1-8 bit, 1-WDT	20	—	✓	—	—	2.0-5.5	
PIC16C5X: 100-200 ns Instruction Execution, 33 Instructions, 25 mA Source and Sink I/O														
PIC16C55A	768 OTP (512)	24	20	28P, 28JW, 28SP, 28SO, 28SS	—	—	1-8 bit, 1-WDT	40	—	—	—	—	2.5-5.5	
PIC16C56A	1,536 OTP (1,024)	25	12	18P, 18JW, 18SO, 20SS	—	—	1-8 bit, 1-WDT	40	—	—	—	—	2.5-5.5	
PIC16CR56A	1,536 ROM (1,024)	25	12	18P, 18SO, 20SS	—	—	1-8 bit, 1-WDT	20	—	—	—	—	2.5-5.5	
PIC16C58B	3,072 OTP (2,048)	73	12	18P, 18JW, 18SO, 20SS	—	—	1-8 bit, 1-WDT	40	—	—	—	—	2.5-5.5	
PIC16CR58B	3,072 ROM (2,048)	73	12	18P, 18SO, 20SS	—	—	1-8 bit, 1-WDT	20	—	—	—	—	2.5-5.5	
PIC16HV540	768 OTP (512)	25	12	18P, 18JW, 18SO, 20SS	—	—	1-8 bit, 1-WDT	20	—	—	BOR	—	3.5-15	8 high-voltage (15V) I/Os, 4 deep stack, 5 I/Os with wake-up-on-change

*Contact Microchip Technology for availability date.

** Requires ICD specific device with header module – refer to Development Tools.

Abbreviations are found on the last page of the Selector Guide.

Mid-Range 8-Bit PICmicro® Microcontroller Family (14-bit Instruction Set)																
Product	Program Memory Bytes & Type (Words)	EEPROM Data Memory Bytes	RAM Bytes	I/O Pins	Packages	Analog		Digital		Max. Speed MHz	IntOSC	BOR/PLVD	ICD # of Breakpoints	CCP/ECCP	nW	Other Features
						ADC Ch	Comp.	Timers/WDT	Serial I/O							
PIC12FXXX: 1 µs Instruction Execution, 35 Instructions, ICSP™																
PIC12F629	1,792 StdFI (1,024)	128	64	6	8P, 8SN, 8MD	—	1	1-8 bit, 1-16 bit, 1-WDT	—	20	4 MHz	BOR	1**	—	—	
PIC12F635	1,792 StdFI (1,024)	128	64	6	8P, 8SN, 8MD	—	1	1-8 bit, 1-16 bit, 1-WDT	—	20	8 MHz	BOR/PLVD	1**	—	✓	KEELOQ® hardware peripheral, WUR
PIC12F675	1,792 StdFI (1,024)	128	64	6	8P, 8SN, 8MD	4x10-bit	1	1-8 bit, 1-16 bit, 1-WDT	—	20	4 MHz	BOR	1**	—	—	
PIC12F683	3,584 StdFI (2,048)	256	128	6	8P, 8SN, 8MD	4x10-bit	1	1-16 bit, 2-8 bit, 1-WDT	—	20	8 MHz	BOR	1**	1/0	✓	
PIC16FXXX: 200 ns Instruction Execution, 35 Instructions, ICSP™ (except ROM), 25 mA Source and Sink per I/O																
PIC16F627A	1,792 StdFI (1,024)	128	224	16	18P, 18SO, 20SS, 28ML	—	2	1-16 bit, 2-8 bit, 1-WDT	AUSART	20	4 MHz	BOR	1**	1/0	✓	
PIC16F628A	3,584 StdFI (2,048)	128	224	16	18P, 18SO, 20SS, 28ML	—	2	1-16 bit, 2-8 bit, 1-WDT	AUSART	20	4 MHz	BOR	1**	1/0	✓	
PIC16F648A	7,168 StdFI (4,096)	256	256	16	18P, 18SO, 20SS, 28ML	—	2	1-16 bit, 2-8 bit, 1-WDT	AUSART	20	4 MHz	BOR	1**	1/0	✓	
PIC16F630	1,792 StdFI (1,024)	128	64	12	14P, 14SL, 14ST, 16ML	—	1	1-8 bit, 1-16 bit, 1-WDT	—	20	4 MHz	BOR	1**	—	—	
PIC16F636	3,584 StdFI (2,048)	256	128	12	14P, 14SL, 14ST, 16ML	—	2	1-8 bit, 1-16 bit, 1-WDT	—	20	8 MHz	BOR/PLVD	1**	—	✓	KEELOQ® hardware peripheral
NEW PIC16F639	3,584 StdFI (2,048)	256	128	12	20P, 20SO, 20SS	—	2	1-16 bit, 1-8 bit, 1-WDT	—	20	8 MHz	BOR	1**	—	✓	Transponder Analog Front End, KEELOQ® hardware peripheral
PIC16F676	1,792 StdFI (1,024)	128	64	12	14P, 14SL, 14ST, 16ML	8x10-bit	1	1-8 bit, 1-16 bit, 1-WDT	—	20	4 MHz	BOR	1**	—	—	
PIC16F684	3,584 StdFI (2,048)	256	128	12	14P, 14SL, 14ST, 16ML	8x10-bit	2	1-16 bit, 2-8 bit, 1-WDT	—	20	8 MHz	BOR	1**	0/1	✓	
NEW PIC16F685	7,168 StdFI (4,096)	256	256	18	20P, 20SO, 20SS, 20ML	12x10-bit	2	1-16 bit, 2-8 bit, 1-WDT	—	20	8 MHz	BOR	1**	0/1	✓	
NEW PIC16F687	3,584 StdFI (2,048)	256	128	18	20P, 20SO, 20SS, 20ML	12x10-bit	2	1-16 bit, 1-8 bit, 1-WDT	EUSART, I ² C/SPI	20	8 MHz	BOR	1**	—	✓	
PIC16F688	7,168 StdFI (4,096)	256	256	12	14P, 14SL, 14ST, 16ML	8x10-bit	2	1-8 bit, 1-16 bit, 1-WDT	EUSART	20	8 MHz	BOR	1**	—	✓	
NEW PIC16F689	7,168 StdFI (4,096)	256	256	18	20P, 20SO, 20SS, 20ML	12x10-bit	2	1-16 bit, 1-8 bit, 1-WDT	EUSART, I ² C/SPI	20	8 MHz	BOR	1**	—	✓	
NEW PIC16F690	7,168 StdFI (4,096)	256	256	18	20P, 20SO, 20SS, 20ML	12x10-bit	2	1-16 bit, 2-8 bit, 1-WDT	EUSART, I ² C/SPI	20	8 MHz	BOR	1**	0/1	✓	
PIC16F716	3,584 StdFI (2,048)	—	128	13	18P, 18SO, 20SS	4x8-bit	—	1-16 bit, 2-8 bit, 1-WDT	—	20	—	BOR	1**	0/1	—	
PIC16F72	3,584 StdFI (2,048)	—	128	22	28SP, 28SO, 28SS, 28ML	5x8-bit	—	1-16 bit, 2-8 bit, 1-WDT	I ² C/SPI	20	—	BOR	—	1/0	—	
PIC16F73	7,168 StdFI (4,096)	—	192	22	28SP, 28SO, 28SS, 28ML	5x8-bit	—	1-16 bit, 2-8 bit, 1-WDT	USART, I ² C/SPI	20	—	BOR	—	2/0	—	

*Contact Microchip Technology for availability date.
 ** Requires ICD specific device with header module – refer to Development Tools.
 Abbreviations are found on the last page of the Selector Guide.

Mid-Range 8-Bit PICmicro® Microcontroller Family (14-bit Instruction Set) (continued)

Product	Program Memory Bytes & Type (Words)	EEPROM Data Memory Bytes	RAM Bytes	I/O Pins	Packages	Analog		Digital		Max. Speed MHz	IntOSC	BOR/PBOR/PLVD	ICD # of Breakpoints	CCP/ECCP	nW	Other Features
						ADC Ch	Comp.	Timers/WDT	Serial I/O							
PIC16FXXX: 200 ns Instruction Execution, 35 Instructions, ICSP™ (except ROM), 25 mA Source and Sink per I/O (continued)																
PIC16F737	7,168 StdFI (4,096)	—	368	25	28SP, 28SO, 28SS, 28ML	11x10-bit	2	1-16 bit, 2-8 bit, 1-WDT	AUSART, MI ² C/SPI	20	8 MHz	PBOR/PLVD	1	3/0	✓	
PIC16F74	7,168 StdFI (4,096)	—	192	33	40P, 44ML, 44L, 44PT	8x8-bit	—	1-16 bit, 2-8 bit, 1-WDT	USART, I ² C/SPI	20	—	BOR	—	2/0	—	PSP
PIC16F747	7,168 StdFI (4,096)	—	368	36	40P, 44PT, 44ML	14x10-bit	2	1-16 bit, 2-8 bit, 1-WDT	AUSART, MI ² C/SPI	20	8 MHz	PBOR/PLVD	1	3/0	✓	PSP
PIC16F76	14,336 StdFI (8,192)	—	368	22	28SP, 28SO, 28SS, 28ML	5x8-bit	—	1-16 bit, 2-8 bit, 1-WDT	USART, I ² C/SPI	20	—	BOR	—	2/0	—	
PIC16F767	14,336 StdFI (8,192)	—	368	25	28SP, 28SO, 28SS, 28ML	11x10-bit	2	1-16 bit, 2-8 bit, 1-WDT	AUSART, MI ² C/SPI	20	8 MHz	PBOR/PLVD	1	3/0	✓	
PIC16F77	14,336 StdFI (8,192)	—	368	33	40P, 44ML, 44L, 44PT	8x8-bit	—	1-16 bit, 2-8 bit, 1-WDT	USART, I ² C/SPI	20	—	BOR	—	2/0	—	PSP
PIC16F777	14,336 StdFI (8,192)	—	368	36	40P, 44PT, 44ML	14x10-bit	2	1-16 bit, 2-8 bit, 1-WDT	AUSART, MI ² C/SPI	20	8 MHz	PBOR/PLVD	1	3/0	✓	PSP
NEW PIC16F785	3,584 StdFI (2,048)	256	128	18	20P, 20SO, 20SS, 20ML	12x10-bit	2	1-16 bit, 2-8 bit, 1-WDT	—	20	8 MHz	BOR	1**	1/0	✓	2-phase PWM, 2 x Op Amp, VREF
PIC16F818	1,792 EnhFI (1,024)	128	128	16	18P, 18SO, 20SS, 28ML	5x10-bit	—	1-16 bit, 2-8 bit, 1-WDT	I ² C/SPI	20	8 MHz	BOR	1	1/0	✓	
PIC16F819	3,584 EnhFI (2,048)	256	256	16	18P, 18SO, 20SS, 28ML	5x10-bit	—	1-16 bit, 2-8 bit, 1-WDT	I ² C/SPI	20	8 MHz	BOR	1	1/0	✓	
PIC16F84A	1,792 StdFI (1,024)	64	68	13	18P, 18SO, 20SS	—	—	1-8 bit, 1-WDT	—	20	—	—	—	—	—	
PIC16F87	7,168 EnhFI (4,096)	256	368	16	18P, 18SO, 20SS, 28ML	—	2	1-16 bit, 2-8 bit, 1-WDT	AUSART, I ² C/SPI	20	8 MHz	BOR	1	1/0	✓	
PIC16F870	3,584 EnhFI (2,048)	64	128	22	28SP, 28SO, 28SS	5x10-bit	—	1-16 bit, 2-8 bit, 1-WDT	AUSART	20	—	BOR	1	1/0	—	
PIC16F871	3,584 EnhFI (2,048)	64	128	33	40P, 44L, 44PT	8x10-bit	—	1-16 bit, 2-8 bit, 1-WDT	AUSART	20	—	BOR	1	1/0	—	PSP
PIC16F872	3,584 EnhFI (2,048)	64	128	22	28SP, 28SO, 28SS	5x10-bit	—	1-16 bit, 2-8 bit, 1-WDT	MI ² C/SPI	20	—	BOR	1	1/0	—	
PIC16F873A	7,168 EnhFI (4,096)	128	192	22	28SP, 28SO, 28SS, 28ML	5x10-bit	2	1-16 bit, 2-8 bit, 1-WDT	AUSART, MI ² C/SPI	20	—	BOR	1	2/0	—	
PIC16F874A	7,168 EnhFI (4,096)	128	192	33	40P, 44ML, 44L, 44PT	8x10-bit	2	1-16 bit, 2-8 bit, 1-WDT	AUSART, MI ² C/SPI	20	—	BOR	1	2/0	—	PSP
PIC16F876A	14,336 EnhFI (8,192)	256	368	22	28SP, 28SO, 28SS, 28ML	5x10-bit	2	1-16 bit, 2-8 bit, 1-WDT	AUSART, MI ² C/SPI	20	—	BOR	1	2/0	—	
PIC16F877A	14,336 EnhFI (8,192)	256	368	33	40P, 44ML, 44L, 44PT	8x10-bit	2	1-16 bit, 2-8 bit, 1-WDT	AUSART, MI ² C/SPI	20	—	BOR	1	2/0	—	PSP
PIC16F88	7,168 EnhFI (4,096)	256	368	16	18P, 18SO, 20SS, 28ML	7x10-bit	2	1-16 bit, 2-8 bit, 1-WDT	AUSART, I ² C/SPI	20	8 MHz	BOR	1	1/0	✓	
NEW PIC16F913	7,168 StdFI (4,096)	256	256	25	28P, 28SO, 28SS, 28ML	5x10-bit	2	2-8 bit, 1-16 bit, 1-WDT	AUSART, I ² C/SPI	20	8 MHz	BOR/PLVD	1	1/0	✓	Integrated LCD control modules with 60 segments

*Contact Microchip Technology for availability date.

** Requires ICD specific device with header module – refer to Development Tools. Abbreviations are found on the last page of the Selector Guide.

Mid-Range 8-Bit PICmicro® Microcontroller Family (14-bit Instruction Set) (continued)																
Product	Program Memory Bytes & Type (Words)	EEPROM Data Memory Bytes	RAM Bytes	I/O Pins	Packages	Analog		Digital		Max. Speed MHz	IntOSC	BOR/PBOR/PLVD	ICD # of Breakpoints	CCP/ECCP	nW	Other Features
						ADC Ch	Comp.	Timers/WDT	Serial I/O							
PIC16FXXX: 200 ns Instruction Execution, 35 Instructions, ICSP™ (except ROM), 25 mA Source and Sink per I/O (continued)																
NEW PIC16F914	7,168 StdFI (4,096)	256	256	36	40P, 44PT, 44ML	8x10-bit	2	2-8 bit, 1-16 bit, 1-WDT	AUSART, I ² C/SPI	20	8 MHz	BOR/PLVD	1	2/0	✓	Integrated LCD control modules with 96 segments
NEW PIC16F916	14,336 StdFI (8,192)	256	352	25	28P, 28SO, 28SS, 28ML	5x10-bit	2	2-8 bit, 1-16 bit, 1-WDT	AUSART, I ² C/SPI	20	8 MHz	BOR/PLVD	1	1/0	✓	Integrated LCD control modules with 60 segments
NEW PIC16F917	14,336 StdFI (8,192)	256	352	36	40P, 44PT, 44ML	8x10-bit	2	2-8 bit, 1-16 bit, 1-WDT	AUSART, I ² C/SPI	20	8 MHz	BOR/PLVD	1	2/0	✓	Integrated LCD control modules with 96 segments
NEW PIC16F946	14,336 StdFI (8,192)	256	336	53	64PT	8x10-bit	2	1-16 bit, 2-8 bit, 1-WDT	AUSART/I ² C/SPI	20	8 MHz 32 kHz	BOR/PLVD	1	2/0	✓	Integrated LCD control modules with 168 segments
PIC16CXXX: 100-200 ns Instruction Execution, 35 Instructions, ICSP™ (except ROM), 25 mA Source and Sink per I/O																
PIC14000	7,168 OTP (4,096)	—	192	20	28SP, 28SO, 28SS, 28JW	8 SLAC	2	1-8 bit, 1-16 bit, 1-WDT	I ² C/SMB	20	4 MHz	—	—	—	—	Temperature Sensor, Program Reference Generator
PIC16C432	3,584 OTP (2,048)	—	128	12	20SS, 20P, 20JW	—	2	1-8 bit, 1-WDT	LIN	20	—	BOR	—	—	—	LIN XCVR, 18V/40 mA
PIC16C433	3,584 OTP (2,048)	—	128	6	18SO, 18P, 18JW	4x8-bit	—	1-8 bit, 1-WDT	LIN	10	4 MHz	—	—	—	—	LIN XCVR, 18V/40 mA
PIC16C554	896 OTP (512)	—	80	13	18P, 18SO, 18JW, 20SS	—	—	1-8 bit, 1-WDT	—	20	—	—	—	—	—	
PIC16C558	3,584 OTP (2,048)	—	128	13	18P, 18SO, 18JW, 20SS	—	—	1-8 bit, 1-WDT	—	20	—	—	—	—	—	
PIC16C62B	3,584 OTP (2,048)	—	128	22	28SP, 28SO, 28SS, 28JW, 28ML	—	—	1-16 bit, 2-8 bit, 1-WDT	I ² C/SPI	20	—	BOR	—	1/0	—	
PIC16C620A	896 OTP (512)	—	96	13	18P, 18SO, 18JW, 20SS	—	2	1-8 bit, 1-WDT	—	40	—	BOR	—	—	—	
PIC16CR620A	896 ROM (512)	—	96	13	18P, 18SO, 20SS	—	2	1-8 bit, 1-WDT	—	20	—	BOR	—	—	—	
PIC16C621A	1,792 OTP (1,024)	—	96	13	18P, 18SO, 18JW, 20SS	—	2	1-8 bit, 1-WDT	—	40	—	BOR	—	—	—	
PIC16C622A	3,584 OTP (2,048)	—	128	13	18P, 18SO, 18JW, 20SS	—	2	1-8 bit, 1-WDT	—	40	—	BOR	—	—	—	
PIC16C63A	7,168 OTP (4,096)	—	192	22	28SP, 28SO, 28SS, 28JW, 28ML	—	—	1-16 bit, 2-8 bit, 1-WDT	USART, I ² C/SPI	20	—	BOR	—	2/0	—	
PIC16CR63	7,168 ROM (4,096)	—	192	22	28SP, 28SO, 28SS	—	—	1-16 bit, 2-8 bit, 1-WDT	USART, I ² C/SPI	20	—	BOR	—	2/0	—	
PIC16C65B	7,168 OTP (4,096)	—	192	33	40P, 40JW, 44L, 44PQ, 44PT	—	—	1-16 bit, 2-8 bit, 1-WDT	USART, I ² C/SPI	20	—	BOR	—	2/0	—	PSP
PIC16CR65	7,168 ROM (4,096)	—	192	33	40P, 44L, 44PQ, 44PT	—	—	1-16 bit, 2-8 bit, 1-WDT	USART, I ² C/SPI	20	—	BOR	—	2/0	—	PSP
PIC16C717	3,584 OTP (2,048)	—	256	16	18P, 18SO, 18JW, 20SS	6x10-bit	—	1-16 bit, 2-8 bit, 1-WDT	M ² C/SPI	20	4 MHz	PBOR/PLVD	—	0/1	—	
PIC16CR72	3,584 ROM (2,048)	—	128	22	28SP, 28SO, 28SS	5x8-bit	—	1-16 bit, 2-8 bit, 1-WDT	I ² C/SPI	20	—	BOR	—	1/0	—	
PIC16C745	14,336 OTP (8,192)	—	256	22	28SP, 28SO, 28JW	5x8-bit	—	1-16 bit, 2-8 bit, 1-WDT	USART, low-speed USB	24	—	BOR	—	2/0	—	USB 1.1, 64 bytes dual port RAM

*Contact Microchip Technology for availability date.
 ** Requires ICD specific device with header module – refer to Development Tools.
 Abbreviations are found on the last page of the Selector Guide.

Mid-Range 8-Bit PICmicro® Microcontroller Family (14-bit Instruction Set) (continued)

Product	Program Memory Bytes & Type (Words)	EEPROM Data Memory Bytes	RAM Bytes	I/O Pins	Packages	Analog		Digital		Max. Speed MHz	IntOSC	BOR/PBOR/PLVD	ICD # of Breakpoints	CCP/ECCP	nW	Other Features
						ADC Ch	Comp.	Timers/WDT	Serial I/O							
PIC16CXXX: 100-200 ns Instruction Execution, 35 Instructions, ICSP™ (except ROM), 25 mA Source and Sink per I/O (continued)																
PIC16C765	14,336 OTP (8,192)	—	256	33	40P, 40JW, 44L, 44PT	8x8-bit	—	1-16 bit, 2-8 bit, 1-WDT	USART, low-speed USB	24	—	BOR	—	2/0	—	USB 1.1, 64 bytes dual port RAM, PSP
PIC16C770	3,584 OTP (2,048)	—	256	16	20P, 20SO, 20JW, 20SS	6x12-bit	—	1-16 bit, 2-8 bit, 1-WDT	M ² C/SPI	20	4 MHz	PBOR/PLVD	—	0/1	—	
PIC16C771	7,168 OTP (4,096)	—	256	16	20P, 20SO, 20JW, 20SS	6x12-bit	—	1-16 bit, 2-8 bit, 1-WDT	M ² C/SPI	20	4 MHz	PBOR/PLVD	—	0/1	—	
PIC16C773	7,168 OTP (4,096)	—	256	22	28SP, 28SO, 28SS, 28JW	6x12-bit	—	1-16 bit, 2-8 bit, 1-WDT	AUSART, M ² C/SPI	20	—	PBOR/PLVD	—	2/0	—	
PIC16C774	7,168 OTP (4,096)	—	256	33	40P, 40JW, 44L, 44PQ, 44PT	10x12-bit	—	1-16 bit, 2-8 bit, 1-WDT	AUSART, M ² C/SPI	20	—	PBOR/PLVD	—	2/0	—	PSP
PIC16C781	1,792 OTP (1,024)	—	128	16	20P, 20SO, 20SS, 20JW	8x8-bit	2	1-16 bit, 2-8 bit, 1-WDT	—	20	4 MHz	PBOR	—	—	—	Op Amp, PSMC, DAC
PIC16C782	3,584 OTP (2,048)	—	128	16	20P, 20SO, 20SS, 20JW	8x8-bit	2	1-16 bit, 2-8 bit, 1-WDT	—	20	4 MHz	PBOR/PLVD	—	—	—	Op Amp, PSMC, DAC
PIC16C925	7,168 OTP (4,096)	—	176	52	68CL, 68L, 64PT	5x10-bit	—	1-16 bit, 2-8 bit, 1-WDT	I ² C/SPI	20	—	BOR	—	1/0	—	LCD module, static, 1/2, 1/3, 1/4 multiplex
PIC16C926	14,336 OTP (8,192)	—	336	52	68CL, 68L, 64PT	5x10-bit	—	1-16 bit, 2-8 bit, 1-WDT	I ² C/SPI	20	—	BOR	—	1/0	—	LCD module, static, 1/2, 1/3, 1/4 multiplex

*Contact Microchip Technology for availability date.

** Requires ICD specific device with header module – refer to Development Tools.

Abbreviations are found on the last page of the Selector Guide.

High-Performance 8-Bit PICmicro® Microcontroller Family (16-bit Instruction Set)

Product	Program Memory Bytes & Type (Words)	EEPROM Data Memory Bytes	RAM Bytes	I/O Pins	Packages	Analog		Digital		Max. Speed MHz	IntOSC	BOR/PBOR/PLVD	ICD # of Breakpoints	CCP/ECCP	nW	Other Features
						ADC Ch	Comp.	Timers/WDT	Serial I/O							
PIC18 Flash MCUs: 10 MIPS, V_{DD} = 2.0 - 5.5V, Upwardly Compatible with PIC16C, 77 Instructions, C Compiler Efficient Instruction Set																
PIC18C601	ROM-less	—	1536	26	64PT, 68L	8x10-bit 30 ksp/s	—	3-16 bit, 1-8 bit, 1-WDT	AUSART, M ² C/SPI	25	—	—	—	2/0	—	256 KB EMA, Bootloader RAM
PIC18C801	ROM-less	—	1536	37	80PT, 84L	12x10-bit 30 ksp/s	—	3-16 bit, 1-8 bit, 1-WDT	AUSART, M ² C/SPI	25	—	—	—	2/0	—	2 MB EMA, Bootloader RAM
PIC18F1220	4,096 EnhFI (2,048)	256	256	16	18P, 18SO, 20SS, 28ML	7x10-bit 30 ksp/s	—	3-16 bit, 1-8 bit, 1-WDT	EUSART	40	8 MHz 32 kHz	PBOR/PLVD	1	0/1	✓	
NEW PIC18F1230*	4,096 EnhFI (2,048)	128	256	16	18P, 18SO, 20SS, 28ML	4x10-bit 100 ksp/s	3	2-16 bit, 1-WDT	EUSART	40	8 MHz 32 kHz	PBOR/PLVD	3	—	✓	6 channel 14-bit Motor Control PWMs
PIC18F1320	8,192 EnhFI (4,096)	256	256	16	18P, 18SO, 20SS, 28ML	7x10-bit 30 ksp/s	—	3-16 bit, 1-8 bit, 1-WDT	EUSART	40	8 MHz 32 kHz	PBOR/PLVD	1	0/1	✓	
NEW PIC18F1330*	8,192 EnhFI (4,096)	128	256	16	18P, 18SO, 20SS, 28ML	4x10-bit 100 ksp/s	3	2-16 bit, 1-WDT	EUSART	40	8 MHz 32 kHz	PBOR/PLVD	3	—	✓	6 channel 14-bit Motor Control PWMs
PIC18F2220	4,096 EnhFI (2,048)	256	512	25	28SP, 28SO	10x10-bit 30 ksp/s	2	3-16 bit, 1-8 bit, 1-WDT	AUSART, M ² C/SPI	40	8 MHz 32 kHz	PBOR/PLVD	1	2/0	✓	

*Contact Microchip Technology for availability date.

Abbreviations are found on the last page of the Selector Guide.

High-Performance 8-Bit PICmicro® Microcontroller Family (16-bit Instruction Set) (continued)

Product	Program Memory Bytes & Type (Words)	EEPROM Data Memory Bytes	RAM Bytes	I/O Pins	Packages	Analog		Digital		Max. Speed MHz	IntOSC	BOR/PBOR/PLVD	ICD # of Breakpoints	CCP/ECCP	nW	Other Features	
						ADC Ch	Comp.	Timers/WDT	Serial I/O								
PIC18 Flash MCUs: 10 MIPS, V_{DD} = 2.0 - 5.5V, Upwardly Compatible with PIC16C, 77 Instructions, C Compiler Efficient Instruction Set (continued)																	
NEW	PIC18F2221*	4,096 EnhFI (2,048)	256	512	25	28SP, 28SO, 28ML	10x10-bit 100 ksps	2	3-16 bit, 1-8 bit, 1-WDT	EUSART, MI ² C/SPI	40	8 MHz 32 kHz	PBOR/PLVD	3	2/0	✓	
	PIC18F2320	8,192 EnhFI (4,096)	256	512	25	28SP, 28SO	10x10-bit 30 ksps	2	3-16 bit, 1-8 bit, 1-WDT	AUSART, MI ² C/SPI	40	8 MHz 32 kHz	PBOR/PLVD	1	2/0	✓	
NEW	PIC18F2321*	8,192 EnhFI (4,096)	256	512	25	28SP, 28SO, 28ML	10x10-bit 100 ksps	2	3-16 bit, 1-8 bit, 1-WDT	EUSART, MI ² C/SPI	40	8 MHz 32 kHz	PBOR/PLVD	3	2/0	✓	
	PIC18F2331	8,192 EnhFI (4,096)	256	768	24	28SP, 28SO, 28MM	5x10-bit, 200 ksps	—	3-16 bit, 1-8 bit, 1-WDT	EUSART, I ² C/SPI	40	8 MHz 32 kHz	PBOR/PLVD	1	2/0	✓	6-channel 14-bit Motor Control PWMs, 2-ch Quadrature Encoder
	PIC18F2410	16,384 StdFI (8,192)	—	768	25	28SP, 28SO, 28ML	10x10-bit 100 ksps	2	3-16 bit, 1-8 bit, 1-WDT	EUSART, MI ² C/SPI	40	8 MHz 32 kHz	PBOR/PLVD	3	2/0	✓	
	PIC18F2420	16,384 EnhFI (8,192)	256	768	25	28SP, 28SO, 28ML	10x10-bit 100 ksps	2	3-16 bit, 1-8 bit, 1-WDT	EUSART, MI ² C/SPI	40	8 MHz 32 kHz	PBOR/PLVD	3	2/0	✓	
NEW	PIC18LF2423*	16,384 EnhFI (8,192)	256	768	25	28SP, 28SO, 28ML	10x12-bit 100 ksps	2	3-16 bit, 1-8 bit, 1-WDT	EUSART, MI ² C/SPI	32	8 MHz 32 kHz	PBOR/PLVD	3	2/0	✓	V _{DD} = 2.7 - 3.6V
	PIC18F2431	16,384 EnhFI (8,192)	256	768	24	28SP, 28SO, 28MM	5x10-bit, 200 ksps	—	3-16 bit, 1-8 bit, 1-WDT	EUSART, I ² C/SPI	40	8 MHz 32 kHz	PBOR/PLVD	1	2/0	✓	6-channel 14-bit Motor Control PWMs, 2-ch Quadrature Encoder
	PIC18F2450*	16,384 EnhFI (8,192)	—	768	23	28SP, 28SO, 28ML	10x10-bit, 100 ksps	—	2-16 bit, 1-8 bit, 1-WDT	USB 2.0, AUSART	48	8 MHz 32 kHz	PBOR/PLVD	3	1/0	✓	Full-Speed USB 2.0 Compliant
	PIC18F2455	24,576 EnhFI (12,288)	256	2048	23	28SP, 28SO	11x10-bit 100 ksps	2	3-16 bit, 1-8 bit, 1-WDT	USB 2.0, MI ² C/SPI, EUSART	48	8 MHz 32 kHz	PBOR/PLVD	3	2/0	✓	Full-Speed USB 2.0 Compliant
	PIC18F2480	16,384 EnhFI (8,192)	256	768	25	28SP, 28SO, 28ML	8x10-bit 100 ksps	—	3-16 bit, 1-8 bit, 1-WDT	CAN 2.0B, MI ² C/SPI, EUSART	40	8 MHz 32 kHz	PBOR/PLVD	3	1/0	✓	ECAN™ technology
	PIC18F2510	32,768 StdFI (16,384)	—	1536	25	28SP, 28SO, 28ML	10x10-bit 100 ksps	2	3-16 bit, 1-8 bit, 1-WDT	EUSART, MI ² C/SPI	40	8 MHz 32 kHz	PBOR/PLVD	3	2/0	✓	
	PIC18F2520	32,768 EnhFI (16,384)	256	1536	25	28SP, 28SO, 28ML	10x10-bit 100 ksps	2	3-16 bit, 1-8 bit, 1-WDT	EUSART, MI ² C/SPI	40	8 MHz 32 kHz	PBOR/PLVD	3	2/0	✓	
NEW	PIC18LF2523*	32,768 EnhFI (16,384)	256	1536	25	28SP, 28SO, 28ML	10x12-bit 100 ksps	2	3-16 bit, 1-8 bit, 1-WDT	EUSART, MI ² C/SPI	32	8 MHz 32 kHz	PBOR/PLVD	3	2/0	✓	V _{DD} = 2.7 - 3.6V
	PIC18F2515	49,152 StdFI (24,576)	—	3968	25	28SP, 28SO	10x10-bit 100 ksps	2	3-16 bit, 1-8 bit, 1-WDT	EUSART, MI ² C/SPI	40	8 MHz 32 kHz	PBOR/PLVD	3	2/0	✓	
	PIC18F2525	49,152 EnhFI (24,576)	1024	3968	25	28SP, 28SO	10x10-bit 100 ksps	2	3-16 bit, 1-8 bit, 1-WDT	EUSART, MI ² C/SPI	40	8 MHz 32 kHz	PBOR/PLVD	3	2/0	✓	
	PIC18F2550	32,768 EnhFI (16,384)	256	2048	23	28SP, 28SO	11x10-bit 100 ksps	2	3-16 bit, 1-8 bit, 1-WDT	USB 2.0, MI ² C/SPI, EUSART	48	8 MHz 32 kHz	PBOR/PLVD	3	2/0	✓	Full-Speed USB 2.0 Compliant
	PIC18F2580	32,768 EnhFI (16,384)	256	1536	25	28SP, 28SO, 28ML	8x10-bit 100 ksps	—	3-16 bit, 1-8 bit, 1-WDT	CAN 2.0B, MI ² C/SPI, EUSART	40	8 MHz 32 kHz	PBOR/PLVD	3	1/0	✓	ECAN™ technology

*Contact Microchip Technology for availability date.
Abbreviations are found on the last page of the Selector Guide.

High-Performance 8-Bit PICmicro® Microcontroller Family (16-bit Instruction Set) (continued)

Product	Program Memory Bytes & Type (Words)	EEPROM Data Memory Bytes	RAM Bytes	I/O Pins	Packages	Analog		Digital		Max. Speed MHz	IntOSC	BOR/PBOR/PLVD	ICD # of Breakpoints	CCP/ECCP	nW	Other Features
						ADC Ch	Comp.	Timers/WDT	Serial I/O							
PIC18 Flash MCUs: 10 MIPS, V_{DD} = 2.0 - 5.5V, Upwardly Compatible with PIC16C, 77 Instructions, C Compiler Efficient Instruction Set (continued)																
PIC18F2585	49,152 EnhFI (24,576)	1024	3328	25	28SP, 28SO	8x10-bit 100 ksp/s	—	3-16 bit, 1-8 bit, 1-WDT	EUSART, MI ² C/SPI	40	8 MHz 32 kHz	PBOR/ PLVD	3	1/0	✓	ECAN™ technology
PIC18F2610	65,536 StdFI (32,768)	—	3968	25	28SP, 28SO	10x10-bit 100 ksp/s	2	3-16 bit, 1-8 bit, 1-WDT	EUSART, MI ² C/SPI	40	8 MHz 32 kHz	PBOR/ PLVD	3	2/0	✓	
PIC18F2620	65,536 EnhFI (32,768)	1024	3968	25	28SP, 28SO	10x10-bit 100 ksp/s	2	3-16 bit, 1-8 bit, 1-WDT	EUSART, MI ² C/SPI	40	8 MHz 32 kHz	PBOR/ PLVD	3	2/0	✓	
PIC18F2680	65,536 EnhFI (32,768)	1024	3328	25	28SP, 28SO	8x10-bit 100 ksp/s	—	3-16 bit, 1-8 bit, 1-WDT	CAN 2.0B, MI ² C/SPI, EUSART	40	8 MHz 32 kHz	PBOR/ PLVD	3	1/0	✓	ECAN™ technology
PIC18F4220	4,096 EnhFI (2,048)	256	512	36	40P, 44ML, 44PT	13x10-bit 30 ksp/s	2	3-16 bit, 1-8 bit, 1-WDT	AUSART, MI ² C/SPI	40	8 MHz 32 kHz	PBOR/ PLVD	1	1/1	✓	PSP
NEW PIC18F4221*	4,096 EnhFI (2,048)	256	512	36	40P, 44ML, 44PT	13x10-bit 100 ksp/s	2	3-16 bit, 1-8 bit, 1-WDT	EUSART, MI ² C/SPI	40	8 MHz 32 kHz	PBOR/ PLVD	3	1/1	✓	PSP
PIC18F4320	8,192 EnhFI (4,096)	256	512	36	40P, 44ML, 44PT	13x10-bit 30 ksp/s	2	3-16 bit, 1-8 bit, 1-WDT	AUSART, MI ² C/SPI	40	8 MHz 32 kHz	PBOR/ PLVD	1	1/1	✓	PSP
NEW PIC18F4321*	8,192 EnhFI (4,096)	256	512	36	40P, 44ML, 44PT	13x10-bit 100 ksp/s	2	3-16 bit, 1-8 bit, 1-WDT	EUSART, MI ² C/SPI	40	8 MHz 32 kHz	PBOR/ PLVD	3	1/1	✓	PSP
PIC18F4331	8,192 EnhFI (4,096)	256	768	36	40P, 44ML, 44PT	9x10-bit 200 ksp/s	—	3-16 bit, 1-8 bit, 1-WDT	EUSART, I ² C/SPI	40	8 MHz 32 kHz	PBOR/ PLVD	1	2/0	✓	8-channel 14-bit Motor Control PWMs, 2-ch Quadrature Encoder
PIC18F4410	16,384 StdFI (8,192)	—	768	36	40P, 44ML, 44PT	13x10-bit 100 ksp/s	2	3-16 bit, 1-8 bit, 1-WDT	EUSART, MI ² C/SPI	40	8 MHz 32 kHz	PBOR/ PLVD	3	1/1	✓	PSP
PIC18F4420	16,384 EnhFI (8,192)	256	768	36	40P, 44ML, 44PT	13x10-bit 100 ksp/s	2	3-16 bit, 1-8 bit, 1-WDT	EUSART, MI ² C/SPI	40	8 MHz 32 kHz	PBOR/ PLVD	3	1/1	✓	PSP
NEW PIC18LF4423*	16,384 EnhFL (8,192)	256	768	36	40P, 44ML, 44PT	13x12-bit 100 ksp/s	2	3-16 bit, 1-8 bit, 1-WDT	EUSART, MI ² C/SPI	32	8 MHz 32 kHz	PBOR/ PLVD	3	1/1	✓	V _{DD} = 2.7 - 3.6V, PSP
PIC18F4431	16,384 EnhFI (8,192)	256	768	36	40P, 44ML, 44PT	9x10-bit 200 ksp/s	—	3-16 bit, 1-8 bit, 1-WDT	EUSART, I ² C/SPI	40	8 MHz 32 kHz	PBOR/ PLVD	1	2/0	✓	8-channel 14-bit Motor Control PWMs, 2-ch Quadrature Encoder
PIC18F4450*	16,384 EnhFI (8,192)	—	768	34	40P, 44ML, 44PT	13x10-bit 100 ksp/s	—	2-16 bit, 1-8 bit, 1-WDT	USB2.0 AUSART	48	8 MHz 32 kHz	PBOR/ PLVD	3	1/0	✓	Full-Speed USB 2.0 Compliant
PIC18F4455	24,576 EnhFI (12,288)	256	2048	34	40P, 44ML, 44PT	13x10-bit 100 ksp/s	2	3-16 bit, 1-8 bit, 1-WDT	USB 2.0, MI ² C/SPI, EUSART	48	8 MHz 32 kHz	PBOR/ PLVD	3	1/1	✓	Full-Speed USB 2.0 Compliant, Streaming Port
PIC18F4480	16,384 EnhFI (8,192)	256	768	36	40P, 44ML, 44PT	11x10-bit 100 ksp/s	2	3-16 bit, 1-8 bit, 1-WDT	CAN 2.0B, MI ² C/SPI, EUSART	40	8 MHz 32 kHz	PBOR/ PLVD	3	1/1	✓	ECAN™ technology
PIC18F4510	32,768 StdFI (16,384)	—	1536	36	40P, 44ML, 44PT	13x10-bit 100 ksp/s	2	3-16 bit, 1-8 bit, 1-WDT	EUSART, MI ² C/SPI	40	8 MHz 32 kHz	PBOR/ PLVD	3	1/1	✓	PSP
PIC18F4520	32,768 EnhFI (16,384)	256	1536	36	40P, 44ML, 44PT	13x10-bit 100 ksp/s	2	3-16 bit, 1-8 bit, 1-WDT	EUSART, MI ² C/SPI	40	8 MHz 32 kHz	PBOR/ PLVD	3	1/1	✓	PSP
NEW PIC18LF4523*	32,768 EnhFI (16,384)	256	1536	36	40P, 44ML, 44PT	13x12-bit 100 ksp/s	2	3-16 bit, 1-8 bit, 1-WDT	EUSART, MI ² C/SPI	32	8 MHz 32 kHz	PBOR/ PLVD	3	1/1	✓	V _{DD} = 2.7 - 3.6V, PSP

*Contact Microchip Technology for availability date.

Abbreviations are found on the last page of the Selector Guide.

High-Performance 8-Bit PICmicro® Microcontroller Family (16-bit Instruction Set) (continued)

Product	Program Memory Bytes & Type (Words)	EEPROM Data Memory Bytes	RAM Bytes	I/O Pins	Packages	Analog		Digital		Max. Speed MHz	IntOSC	BOR/PBOR/PLVD	ICD # of Breakpoints	CCP/ECCP	nW	Other Features
						ADC Ch	Comp.	Timers/WDT	Serial I/O							
PIC18 Flash MCUs: 10 MIPS, VDD = 2.0 - 5.5V, Upwardly Compatible with PIC16C, 77 Instructions, C Compiler Efficient Instruction Set (continued)																
PIC18F4515	49,152 StdFI (24,576)	—	3968	36	40P, 44ML, 44PT	13x10-bit 100 kspcs	2	3-16 bit, 1-8 bit, 1-WDT	EUSART, MI ² C/SPI	40	8 MHz 32 kHz	PBOR/ PLVD	3	1/1	✓	PSP
PIC18F4525	49,152 EnhFI (24,576)	1024	3968	36	40P, 44ML, 44PT	13x10-bit 100 kspcs	2	3-16 bit, 1-8 bit, 1-WDT	EUSART, MI ² C/SPI	40	8 MHz 32 kHz	PBOR/ PLVD	3	1/1	✓	PSP
PIC18F4580	32,768 EnhFI (16,384)	256	1536	36	40P, 44ML, 44PT	11x10-bit 100 kspcs	2	3-16 bit, 1-8 bit, 1-WDT	CAN 2.0B, MI ² C/SPI, EUSART	40	8 MHz 32 kHz	PBOR/ PLVD	3	1/1	✓	ECAN™ technology
PIC18F4550	32,768 EnhFI (16,384)	256	2048	34	40P, 44ML, 44PT	13x10-bit 100 kspcs	2	3-16 bit, 1-8 bit, 1-WDT	USB 2.0, MI ² C/SPI, EUSART	48	8 MHz 32 kHz	PBOR/ PLVD	3	1/1	✓	Full-Speed USB 2.0 Compliant, Streaming Port
PIC18F4585	49,152 EnhFI (24,576)	1024	3328	36	40P, 44ML, 44PT	11x10-bit 100 kspcs	2	3-16 bit, 1-8 bit, 1-WDT	CAN 2.0B, MI ² C/SPI, EUSART	40	8 MHz 32 kHz	PBOR/ PLVD	3	1/1	✓	ECAN™ technology
PIC18F4610	65,536 StdFI (32,768)	—	3968	36	40P, 44ML, 44PT	13x10-bit 100 kspcs	2	3-16 bit, 1-8 bit, 1-WDT	EUSART, MI ² C/SPI	40	8 MHz 32 kHz	PBOR/ PLVD	3	1/1	✓	PSP
PIC18F4620	65,536 EnhFI (32,768)	1024	3968	36	40P, 44ML, 44PT	13x10-bit 100 kspcs	2	3-16 bit, 1-8 bit, 1-WDT	EUSART, MI ² C/SPI	40	8 MHz 32 kHz	PBOR/ PLVD	3	1/1	✓	PSP
PIC18F4680	65,536 EnhFI (32,768)	1024	3328	36	40P, 44ML, 44PT	11x10-bit 100 kspcs	2	3-16 bit, 1-8 bit, 1-WDT	CAN 2.0B, MI ² C/SPI, EUSART	40	8 MHz 32 kHz	PBOR/ PLVD	3	1/1	✓	ECAN™ technology
PIC18F6310	8,192 StdFI (4,096)	—	768	54	64PT	12x10-bit 100 kspcs	2	3-16 bit, 1-8 bit, 1-WDT	MI ² C/SPI, EUSART, AUSART	40	8 MHz 32 kHz	PBOR/ PLVD	3	3/0	3	EMA
PIC18F6410	16,384 StdFI (8,192)	—	768	54	64PT	12x10-bit 100 kspcs	2	3-16 bit, 1-8 bit, 1-WDT	MI ² C/SPI, EUSART, AUSART	40	8 MHz 32 kHz	PBOR/ PLVD	3	3/0	✓	EMA
PIC18F6390	8,192 StdFI (4,096)	—	768	50	64PT	12x10-bit 100 kspcs	2	3-16 bit, 1-8 bit, 1-WDT	MI ² C/SPI, EUSART, AUSART	40	8 MHz 32 kHz	PBOR/ PLVD	3	2/0	✓	LCD: up to 128 Segments
PIC18F6490	16,384 StdFI (8,192)	—	768	50	64PT	12x10-bit 100 kspcs	2	3-16 bit, 1-8 bit, 1-WDT	MI ² C/SPI, EUSART, AUSART	40	8 MHz 32 kHz	PBOR/ PLVD	3	2/0	✓	LCD: up to 128 Segments
PIC18F6520	32,768 EnhFI (16,384)	1024	2048	52	64PT	12x10-bit 30 kspcs	2	3-16 bit, 2-8 bit, 1-WDT	2xAUSART, MI ² C/SPI	40	—	PBOR/ PLVD	1	5/0	—	PSP
NEW PIC18F6527	49,152 EnhFI (24,576)	1024	3936	54	64PT	12x10-bit 100 kspcs	2	3-16 bit, 2-8 bit, 1-WDT	2xEUSART, 2xMI ² C/SPI	40	8 MHz 32 kHz	PBOR/ PLVD	3	2/3	✓	PSP
PIC18F6585	49,152 EnhFI (24,576)	1024	3328	53	64PT, 68L	12x10-bit 30 kspcs	2	3-16 bit, 1-8 bit, 1-WDT	EUSART, MI ² C/SPI, CAN 2.0B	40	—	PBOR/ PLVD	1	1/1	—	ECAN™ technology
NEW PIC18F6622	65,536 EnhFI (32,768)	1024	3936	54	64PT	12x10-bit 100 kspcs	2	3-16 bit, 2-8 bit, 1-WDT	2xEUSART, 2xMI ² C/SPI	40	8 MHz 32 kHz	PBOR/ PLVD	3	2/3	✓	PSP
PIC18F6627	98,304 EnhFI (49,152)	1024	3936	54	64PT	12x10-bit 100 kspcs	2	3-16 bit, 2-8 bit, 1-WDT	2xEUSART, 2xMI ² C/SPI	40	8 MHz 32 kHz	PBOR/ PLVD	3	2/3	✓	PSP

*Contact Microchip Technology for availability date.
Abbreviations are found on the last page of the Selector Guide.

High-Performance 8-Bit PICmicro® Microcontroller Family (16-bit Instruction Set) (continued)

Product	Program Memory Bytes & Type (Words)	EEPROM Data Memory Bytes	RAM Bytes	I/O Pins	Packages	Analog		Digital		Max. Speed MHz	IntOSC	BOR/PBOR/PLVD	ICD # of Breakpoints	CCP/ECCP	nW	Other Features
						ADC Ch	Comp.	Timers/WDT	Serial I/O							
PIC18 Flash MCUs: 10 MIPS, V_{DD} = 2.0 - 5.5V, Upwardly Compatible with PIC16C, 77 Instructions, C Compiler Efficient Instruction Set (continued)																
PIC18F6680	65,536 EnhFI (32,768)	1024	3328	53	64PT, 68L	12x10-bit 30 ksps	2	3-16 bit, 1-8 bit, 1-WDT	EUSART, MI ² C/SPI, CAN 2.0B	40	—	PBOR/ PLVD	1	1/1	—	ECAN™ technology
PIC18F6722	131,072 EnhFI (65,536)	1024	3936	54	64PT	12x10-bit 100 ksps	2	3-16 bit, 2-8 bit, 1-WDT	2xEUSART, 2xMI ² C/SPI	40	8 MHz 32 kHz	PBOR/ PLVD	3	2/3	✓	PSP
PIC18F8310	8,192 StdFI (4,096)	—	768	70	80PT	12x10-bit 100 ksps	2	3-16 bit, 1-8 bit, 1-WDT	MI ² C/SPI, EUSART, AUSART	40	8 MHz 32 kHz	PBOR/ PLVD	3	3/0	✓	EMA
PIC18F8410	16,384 StdFI (8,192)	—	768	70	80PT	12x10-bit 100 ksps	2	3-16 bit, 2-8 bit, 1-WDT	MI ² C/SPI, EUSART, AUSART	40	8 MHz 32 kHz	PBOR/ PLVD	3	3/0	✓	EMA
PIC18F8390	8,192 StdFI (4,096)	—	768	66	80PT	12x10-bit 100 ksps	2	3-16 bit, 1-8 bit, 1-WDT	MI ² C/SPI, EUSART, AUSART	40	8 MHz 32 kHz	PBOR/ PLVD	3	2/0	✓	LCD: up to 192 Segments
PIC18F8490	16,384 StdFI (8,192)	—	768	66	80PT	12x10-bit 100 ksps	2	3-16 bit, 2-8 bit, 1-WDT	MI ² C/SPI, EUSART, AUSART	40	8 MHz 32 kHz	PBOR/ PLVD	3	2/0	✓	LCD: up to 192 Segments
PIC18F8520	32,768 EnhFI (16,384)	1024	2048	68	80PT	16x10-bit 30 ksps	2	2-8 bit, 3-16 bit, 1-WDT	2xAUSART, MI ² C/SPI	40	—	PBOR/ PLVD	1	5/0	—	PSP, EMA
NEW PIC18F8527	49,152 EnhFI (24,576)	1024	3936	70	80PT	16x10-bit 100 ksps	2	3-16 bit, 2-8 bit, 1-WDT	2xEUSART, 2xMI ² C/SPI	40	8 MHz 32 kHz	PBOR/ PLVD	3	2/3	✓	PSP, EMA
PIC18F8585	49,152 EnhFI (24,576)	1024	3328	69	80PT	16x10-bit 30 ksps	2	3-16 bit, 1-8 bit, 1-WDT	EUSART, MI ² C/SPI, CAN 2.0B	40	—	PBOR/ PLVD	1	1/1	—	ECAN™ technology, EMA
NEW PIC18F8622	65,536 EnhFI (32,768)	1024	3936	70	80PT	16x10-bit 100 ksps	2	3-16 bit, 2-8 bit, 1-WDT	2xEUSART, 2xMI ² C/SPI	40	8 MHz 32 kHz	PBOR/ PLVD	3	2/3	✓	PSP, EMA
PIC18F8627	98,304 EnhFI (49,152)	1024	3936	70	80PT	16x10-bit 100 ksps	2	3-16 bit, 2-8 bit, 1-WDT	2xEUSART, 2xMI ² C/SPI	40	8 MHz 32 kHz	PBOR/ PLVD	3	2/3	✓	PSP, EMA
PIC18F8680	65,536 EnhFI (32,768)	1024	3328	69	80PT	16x10-bit 30 ksps	2	3-16 bit, 1-8 bit, 1-WDT	EUSART, MI ² C/SPI, CAN 2.0B	40	—	PBOR/ PLVD	1	1/1	—	ECAN™ technology, EMA
PIC18F8722	131,072 EnhFI (65,536)	1024	3936	70	80PT	16x10-bit 100 ksps	2	3-16 bit, 2-8 bit, 1-WDT	2xEUSART, 2xMI ² C/SPI	40	8 MHz 32 kHz	PBOR/ PLVD	3	2/3	✓	PSP, EMA
PIC18FXXJXX Flash MCUs: 10 MIPS, V_{DD} = 2.0 - 3.6V, Self-Write, Upwardly Compatible with PIC18/PIC16, 77 Instructions, C Compiler Efficient Instruction Set																
NEW PIC18F24J10	16,384 StdFI (8,192)	—	1024	21	28SP, 28SO, 28SS, 28ML	10x10-bit 100 ksps	2	2-16 bit, 1-8 bit, 1-WDT	EUSART, MI ² C/SPI	40	32 kHz	BOR	3	2/0	✓	
NEW PIC18F25J10	32,768 StdFI (16,384)	—	1024	21	28SP, 28SO, 28SS, 28ML	10x10-bit 100 ksps	2	2-16 bit, 1-8 bit, 1-WDT	EUSART, MI ² C/SPI	40	32 kHz	BOR	3	2/0	✓	
NEW PIC18F44J10	16,384 StdFI (8,192)	—	1024	32	40P, 44ML, 44PT	13x10-bit 100 ksps	2	2-16 bit, 1-8 bit, 1-WDT	EUSART, 2xMI ² C/SPI	40	32 kHz	BOR	3	1/1	✓	PSP
NEW PIC18F45J10	32,768 StdFI (16,384)	—	1024	32	40P, 44ML, 44PT	13x10-bit 100 ksps	2	2-16 bit, 1-8 bit, 1-WDT	EUSART, 2xMI ² C/SPI	40	32 kHz	BOR	3	1/1	✓	PSP
NEW PIC18F65J10	32,768 StdFI (16,384)	—	2048	50	64PT	11x10-bit 100 ksps	2	3-16 bit, 2-8 bit, 1-WDT	2xEUSART, 2xMI ² C/SPI	40	32 kHz	BOR	3	2/3	✓	PSP
NEW PIC18F65J15	49,152 StdFI (24,576)	—	2048	50	64PT	11x10-bit 100 ksps	2	3-16 bit, 2-8 bit, 1-WDT	2xEUSART, 2xMI ² C/SPI	40	32 kHz	BOR	3	2/3	✓	PSP

*Contact Microchip Technology for availability date.

Abbreviations are found on the last page of the Selector Guide.

High-Performance 8-Bit PICmicro® Microcontroller Family (16-bit Instruction Set) (continued)

Product	Program Memory Bytes & Type (Words)	EEPROM Data Memory Bytes	RAM Bytes	I/O Pins	Packages	Analog		Digital		Max. Speed MHz	IntOSC	BOR/PBOR/PLVD	ICD # of Breakpoints	CCP/ECCP	nW	Other Features	
						ADC Ch	Comp.	Timers/WDT	Serial I/O								
PIC18FXXJXX Flash MCUs: 10 MIPS, V_{DD} = 2.0 - 3.6V, Self-Write, Upwardly Compatible with PIC18/PIC16, 77 Instructions, C Compiler Efficient Instruction Set (continued)																	
NEW	PIC18F66J10	65,536 StdFI (32,768)	—	2048	50	64PT	11x10-bit 100 ksps	2	3-16 bit, 2-8 bit, 1-WDT	2xEUSART, 2xMI ² C/SPI	40	32 kHz	BOR	3	2/3	✓	PSP
NEW	PIC18F66J60*	65,536 StdFI (32,768)	—	2048	39	64PT	11x10-bit 100 ksps	2	3-16 bit, 2-8 bit, 1-WDT	EUSART, MI ² C/SPI	42	32 kHz	BOR	3	2/3	✓	10 Base-T Ethernet
NEW	PIC18F66J15	98,304 StdFI (49,152)	—	3936	50	64PT	11x10-bit 100 ksps	2	3-16 bit, 2-8 bit, 1-WDT	2xEUSART, 2xMI ² C/SPI	40	32 kHz	BOR	3	2/3	✓	PSP
NEW	PIC18F66J65*	98,304 StdFI (49,152)	—	3808	39	64PT	11x10-bit 100 ksps	2	3-16 bit, 2-8 bit, 1-WDT	EUSART, MI ² C/SPI	42	32 kHz	BOR	3	2/3	✓	10 Base-T Ethernet
NEW	PIC18F67J10	131,072 StdFL (65,536)	—	3936	50	64PT	11x10-bit 100 ksps	2	3-16 bit, 2-8 bit, 1-WDT	2xEUSART, 2xMI ² C/SPI	40	32 kHz	BOR	3	2/3	✓	PSP
NEW	PIC18F67J60*	131,072 StdFI (65,536)	—	3808	39	64PT	11x10-bit 100 ksps	2	3-16 bit, 2-8 bit, 1-WDT	EUSART, MI ² C/SPI	42	32 kHz	BOR	3	2/3	✓	10 Base-T Ethernet
NEW	PIC18F85J10	32,768 StdFL (16,384)	—	2048	66	80PT	15x10-bit 100 ksps	2	3-16 bit, 2-8 bit, 1-WDT	2xEUSART, 2xMI ² C/SPI	40	32 kHz	BOR	3	2/3	✓	PSP, EMA
NEW	PIC18F85J15	49,152 StdFL (24,576)	—	2048	66	80PT	15x10-bit 100 ksps	2	3-16 bit, 2-8 bit, 1-WDT	2xEUSART, 2xMI ² C/SPI	40	32 kHz	BOR	3	2/3	✓	PSP, EMA
NEW	PIC18F86J10	65,536 StdFL (32,768)	—	2048	66	80PT	15x10-bit 100 ksps	2	3-16 bit, 2-8 bit, 1-WDT	2x EUSART, 2x MI ² C/SPI	40	32 kHz	BOR	3	2/3	✓	PSP, EMA
NEW	PIC18F86J60*	65,536 StdFI (32,768)	—	2048	55	80PT	15x10-bit 100 ksps	2	3-16 bit, 2-8 bit, 1-WDT	2xEUSART, MI ² C/SPI	42	32 kHz	BOR	3	2/3	✓	10 Base-T Ethernet
NEW	PIC18F86J15	98,304 StdFL (49,152)	—	3936	66	80PT	15x10-bit 100 ksps	2	3-16 bit, 2-8 bit, 1-WDT	2x EUSART, 2x MI ² C/SPI	40	32 kHz	BOR	3	2/3	✓	PSP, EMA
NEW	PIC18F86J65*	98,304 StdFI (49,152)	—	3808	55	80PT	15x10-bit 100 ksps	2	3-16 bit, 2-8 bit, 1-WDT	2xEUSART, MI ² C/SPI	42	32 kHz	BOR	3	2/3	✓	10 Base-T Ethernet
NEW	PIC18F87J10	131,072 StdFI (65,536)	—	3936	66	80PT	15x10-bit 100 ksps	2	3-16 bit, 2-8 bit, 1-WDT	2x EUSART, 2x MI ² C/SPI	40	32 kHz	BOR	3	2/3	✓	PSP, EMA
NEW	PIC18F87J60*	131,072 StdFI (65,536)	—	3808	55	80PT	15x10-bit 100 ksps	2	3-16 bit, 2-8 bit, 1-WDT	2xEUSART, MI ² C/SPI	42	32 kHz	BOR	3	2/3	✓	10 Base-T Ethernet
NEW	PIC18F96J60*	65,536 StdFI (32,768)	—	2048	70	100PT, 100PF	16x10-bit 100 ksps	2	3-16 bit, 2-8 bit, 1-WDT	2xEUSART, 2xMI ² C/SPI	42	32 kHz	BOR	3	2/3	✓	PSP, EMA, 10 Base-T Ethernet
NEW	PIC18F96J65*	98,304 StdFI (49,152)	—	3808	70	100PT, 100PF	16x10-bit 100 ksps	2	3-16 bit, 2-8 bit, 1-WDT	2xEUSART, 2xMI ² C/SPI	42	32 kHz	BOR	3	2/3	✓	PSP, EMA, 10 Base-T Ethernet
NEW	PIC18F97J60*	131,072 StdFI (65,536)	—	3808	70	100PT, 100PF	16x10-bit 100 ksps	2	3-16 bit, 2-8 bit, 1-WDT	2xEUSART, 2xMI ² C/SPI	42	32 kHz	BOR	3	2/3	✓	PSP, EMA, 10 Base-T Ethernet

*Contact Microchip Technology for availability date.

Abbreviations are found on the last page of the Selector Guide.

PIC24 16-Bit Microcontroller (MCU) Family

Product	Flash Program Memory (Bytes)	RAM (Bytes)	I/O Pins	Packages	Analog		Digital							ECAN™ Technology	IntOSC	Power On Reset	nW	Other Features	
					ADC Ch	Comp.	Timers 16-bit	Input Cap	Output Comp/PWM	RTCC	UART w/ IrDA®	SPI™	I²C™						
PIC24FJ Family 16-bit Flash MCUs: 16 MIPS, V_{DD} = 2.0 - 3.6V, Self-Write Flash																			
NEW	PIC24FJ64GA006	64	8	53	64PT	16x10-bit 500 ksps	2	5	5	5	✓	2	2	2	—	8 MHz 32 kHz	✓	✓	JTAG, PMP
NEW	PIC24FJ64GA008	64	8	69	80PT	16x10-bit 500 ksps	2	5	5	5	✓	2	2	2	—	8 MHz 32 kHz	✓	✓	JTAG, PMP
NEW	PIC24FJ64GA010	64	8	85	100PT 100PF	16x10-bit 500 ksps	2	5	5	5	✓	2	2	2	—	8 MHz 32 kHz	✓	✓	JTAG, PMP
NEW	PIC24FJ96GA006	96	8	53	64PT	16x10-bit 500 ksps	2	5	5	5	✓	2	2	2	—	8 MHz 32 kHz	✓	✓	JTAG, PMP
NEW	PIC24FJ96GA008	96	8	69	80PT	16x10-bit 500 ksps	2	5	5	5	✓	2	2	2	—	8 MHz 32 kHz	✓	✓	JTAG, PMP
NEW	PIC24FJ96GA010	96	8	85	100PT 100PF	16x10-bit 500 ksps	2	5	5	5	✓	2	2	2	—	8 MHz 32 kHz	✓	✓	JTAG, PMP
NEW	PIC24FJ128GA006	128	8	53	64PT	16x10-bit 500 ksps	2	5	5	5	✓	2	2	2	—	8 MHz 32 kHz	✓	✓	JTAG, PMP
NEW	PIC24FJ128GA008	128	8	69	80PT	16x10-bit 500 ksps	2	5	5	5	✓	2	2	2	—	8 MHz 32 kHz	✓	✓	JTAG, PMP
NEW	PIC24FJ128GA010	128	8	85	100PT 100PF	16x10-bit 500 ksps	2	5	5	5	✓	2	2	2	—	8 MHz 32 kHz	✓	✓	JTAG, PMP
PIC24HJ Family 16-bit Flash MCUs: 40 MIPS, V_{DD} = 3.0 - 3.6V, Self-Write Flash																			
NEW	PIC24HJ64GP206	64	8	53	64PT	18x2-bit 500 ksps	—	9	8	8	—	2	2	1	—	8 MHz 32 kHz	✓	✓	JTAG, DMA
NEW	PIC24HJ64GP210	64	8	85	100PT 100PF	32x12-bit 500 ksps	—	9	8	8	—	2	2	2	—	8 MHz 32 kHz	✓	✓	JTAG, DMA
NEW	PIC24HJ256GP206	256	16	53	64PT	18x12-bit 500 ksps	—	9	8	8	—	2	2	2	—	8 MHz 32 kHz	✓	✓	JTAG, DMA
NEW	PIC24HJ256GP610	256	16	85	100PT 100PF	(2) 16x12-bit 500 ksps	—	9	8	8	—	2	2	2	2	8 MHz 32 kHz	✓	✓	JTAG, DMA

Abbreviations are found on the last page of the Selector Guide.

FUTURE PICmicro® MICROCONTROLLER FAMILY PRODUCTS

Mid-Range 8-Bit PICmicro® Microcontroller Family (14-bit Instruction Set)

Product	Program Memory: Bytes & Type (Words)	EEPROM Data Memory Bytes	RAM Bytes	I/O Pins	Packages	Analog		Digital		Max. Speed MHz	IntOSC	BOR/PBOR/PLVD	ICD # of Breakpoints	CCP/ECCP	nW	Other Features
						ADC Channels	Comp.	Timers/WDT	Serial I/O							
PIC12FXXX: 200 ns Instruction Execution, 35 Instructions, 25 mA Source and Sink per I/O																
PIC12F609	1,792 StdFI (1,024)	—	64	6	8P, 8SN, 8MD	—	1	1-16 bit, 1-8 bit, 1-WDT	—	20	8 MHz 32kHz	BOR	1**	—	—	High-Voltage Option with Internal Regulator
PIC12F615	1,792 StdFI (1,024)	—	64	6	8P, 8SN, 8MD	4x10-bit	1	1-16 bit, 2-8 bit, 1-WDT	—	20	8 MHz 32 kHz	BOR	1**	0/1	—	High-Voltage Option with Internal Regulator
PIC12F617	3,584 StdFI (2,048)	—	128	6	8P, 8SN, 8MD	4x10-bit	1	1-16 bit, 2-8 bit, 1-WDT	—	20	8 MHz 32 kHz	BOR	1**	0/1	—	High-Voltage Option with Internal Regulator
PIC16FXXX: 200 ns Instruction Execution, 35 Instructions, ICSP™, 25 mA Source and Sink per I/O																
PIC16F610	1,792 StdFI (1,024)	—	64	12	14P, 14SL, 14ST, 16ML	—	2	1-16 bit, 2-8 bit, 1-WDT	—	20	8 MHz 32 kHz	BOR	1**	—	—	High-Voltage Option with Internal Regulator
PIC16F616	3,584 StdFI (2,048)	—	128	12	14P, 14SL, 14ST, 16ML	8x10-bit	2	1-16 bit, 2-8 bit, 1-WDT	—	20	8 MHz 32 kHz	BOR	1**	0/1	—	High-Voltage Option with Internal Regulator
PIC16F618	7,168 EnhFI (4,096)	—	256	12	14P, 14SL, 14ST, 16ML	8x10-bit	2	1-16 bit, 2-8 bit, 1-WDT	—	20	8 MHz 32 kHz	BOR	1**	0/1	—	High-Voltage Option with Internal Regulator
PIC16F631	1,792 StdFI (1,024)	128	64	18	20P, 20SO, 20SS	—	2	1-16 bit, 1-8 bit, 1-WDT	—	20	8 MHz 32 kHz	BOR	1**	—	✓	
PIC16F677	3,584 StdFI (2,048)	256	128	18	20P, 20SO, 20SS	12x10-bit	2	1-16 bit, 1-8 bit, 1-WDT	—	20	8 MHz 32 kHz	BOR	1**	—	✓	
PIC16F883	7,168 EnhFI (4,096)	256	256	25	28SP, 28SO, 28SS, 28ML	11x10-bit	2	1-16 bit, 2-8 bit, 1-WDT	EUSART, Mi ² C/SPI	20	8 MHz 32 kHz	BOR	1	1/1	✓	
PIC16F884	7,168 EnhFI (4,096)	256	256	36	40P, 44PT, 44ML	14x10-bit	2	1-16 bit, 2-8 bit, 1-WDT	EUSART, Mi ² C/SPI	20	8 MHz 32 kHz	BOR	1	1/1	✓	
PIC16F886	14,336 EnhFI (8,192)	256	368	25	28SP, 28SO, 28SS, 28ML	11x10-bit	2	1-16 bit, 2-8 bit, 1-WDT	EUSART, Mi ² C/SPI	20	8 MHz 32 kHz	BOR	1	1/1	✓	
PIC16F887	14,336 EnhFI (8,192)	256	368	36	40P, 44PT, 44ML	14x10-bit	2	1-16 bit, 2-8 bit, 1-WDT	EUSART, Mi ² C/SPI	20	8 MHz 32 kHz	BOR	1	1/1	✓	
PIC16CRXX: 200 ns Instruction Execution, 35 Instructions, 25 mA Source and Sink per I/O																
PIC16CR73	7,168 ROM (4,096)	—	192	22	28SP, 28SO, 28SS, 28ML	5x8-bit	—	1-16 bit, 2-8 bit, 1-WDT	USART, I ² C/SPI	20	—	BOR	—	2/0	—	
PIC16CR74	7,168 ROM (4,096)	—	192	33	40P, 44ML, 44L, 44PT	8x8-bit	—	1-16 bit, 2-8 bit, 1-WDT	USART, I ² C/SPI	20	—	BOR	—	2/0	—	PSP
PIC16CR76	14,336 ROM (8,192)	—	368	22	28SP, 28SO, 28SS, 28ML	5x8-bit	—	1-16 bit, 2-8 bit, 1-WDT	USART, I ² C/SPI	20	—	BOR	—	2/0	—	
PIC16CR77	14,336 ROM (8,192)	—	368	33	40P, 44ML, 44L, 44PT	8x8-bit	—	1-16 bit, 2-8 bit, 1-WDT	USART, I ² C/SPI	20	—	BOR	—	2/0	—	PSP

** Requires ICD specific device with header module – refer to Development Tools. Abbreviations are found on the last page of the Selector Guide.

High-Performance 8-Bit PICmicro® Microcontroller Family (16-bit Instruction Set)

Product	Program Memory: Bytes & Type (Words)	EEPROM Data Memory Bytes	RAM Bytes	I/O Pins	Packages	Analog	Digital	Max. Speed MHz	IntOSC	BOR/PBOR/PLVD/LVD	ICD # of Breakpoints	CCP/ECCP	nW	Other Features		
PIC18FXXX: Upwardly Compatible with PIC16, 77 Instructions, C Compiler Efficient Instruction Set, Software Stack Capability, Table Read/Write, Switchable Oscillator Sources, 4x PLL, 10-12 MIPS, ICSP™																
PIC18F2685	98,304 EnhFI (49,152)	1024	3328	25	28SP, 28SO	8x10-bit 100 ksps	—	3-16 bit, 1-8 bit, 1-WDT	CAN 2.0B MI ² C/SPI, EUSART	40	8 MHz 32 kHz	PBOR/ PLVD	3	1/0	✓	ECAN™ technology
PIC18F4685	98,304 EnhFI (49,152)	1024	3328	36	40P, 44ML, 44PT	11x10-bit 100 ksps	2	3-16 bit, 1-8 bit, 1-WDT	CAN2.0B MI ² C/SPI, EUSART	40	8 MHz 32 kHz	PBOR/ PLVD	3	1/1	✓	ECAN™ technology
PIC18F6493	16,384 StdFI (8,192)	—	768	50	64PT	12x12-bit 100 ksps	2	3-16 bit, 1-8 bit, 1-WDT	MI ² C/SPI, EUSART, AUSART	32	8 MHz 32 kHz	PBOR/ PLVD	3	2/0	✓	VDD = 2.7-3.6V LCD: up to 192 segments
PIC18F8493	16,384 StdFI (8,192)	—	768	66	80PT	12x12-bit 100 ksps	2	3-16 bit, 2-8 bit, 1-WDT	MI ² C/SPI, EUSART, AUSART	32	8 MHz 32 kHz	PBOR/ PLVD	3	2/0	✓	VDD = 2.7-3.6V LCD: up to 192 segments
PIC18FXXJXX: Flash and ROM MCUs: 10 MIPS, VDD = 2.0 - 3.6V, Self-Write Flash, Upwardly Compatible with PIC18/PIC16, 77 Instructions and C Compiler Efficient Instruction Set																
PIC18F24J11	16,384 StdFI (8,192)	—	2048	21	28SP, 28SO, 28SS, 28ML	10x10-bit 100 ksps	2	3-16 bit, 2-8 bit, 1-WDT	2xEUSART, 2xMI ² C/SPI	48	8 MHz 32 kHz	PBOR/ LVD	3	0/2	✓	Peripheral remapping capability (cross bar), PMP
PIC18F25J11	32,768 StdFI (16,384)	—	2048	21	28SP, 28SO, 28SS, 28ML	10x10-bit 100 ksps	2	3-16 bit, 2-8 bit, 1-WDT	2xEUSART, 2xMI ² C/SPI	48	8 MHz 32 kHz	PBOR/ LVD	3	0/2	✓	Peripheral remapping capability (cross bar), PMP
PIC18F25J16	49,152 StdFI (24,576)	—	3936	21	28SP, 28SO, 28SS, 28ML	10x10-bit 100 ksps	2	3-16 bit, 2-8 bit, 1-WDT	2xEUSART, 2xMI ² C/SPI	48	8 MHz 32 kHz	PBOR/ LVD	3	0/2	✓	Peripheral remapping capability (cross bar), PMP
PIC18F26J11	65,536 StdFI (32,768)	—	3936	21	28SP, 28SO, 28SS, 28ML	10x10-bit 100 ksps	2	3-16 bit, 2-8 bit, 1-WDT	2xEUSART, 2xMI ² C/SPI	48	8 MHz 32 kHz	PBOR/ LVD	3	0/2	✓	Peripheral remapping capability (cross bar), PMP
PIC18F44J11	16,384 StdFI (8,192)	—	2048	32	40P, 44PT, 44ML	13x10-bit 100 ksps	2	3-16 bit, 2-8 bit, 1-WDT	2xEUSART, 2xMI ² C/SPI	48	8 MHz 32 kHz	PBOR/ LVD	3	0/2	✓	Peripheral remapping capability (cross bar), PMP
PIC18F45J11	32,768 StdFI (16,384)	—	2048	32	40P, 44PT, 44ML	13x10-bit 100 ksps	2	3-16 bit, 2-8 bit, 1-WDT	2xEUSART, 2xMI ² C/SPI	48	8 MHz 32 kHz	PBOR/ LVD	3	0/2	✓	Peripheral remapping capability (cross bar), PMP
PIC18F45J16	49,152 StdFI (24,576)	—	3936	32	40P, 44PT, 44ML	13x10-bit 100 ksps	2	3-16 bit, 2-8 bit, 1-WDT	2xEUSART, 2xMI ² C/SPI	48	8 MHz 32 kHz	PBOR/ LVD	3	0/2	✓	Peripheral remapping capability (cross bar), PMP
PIC18F46J11	65,536 StdFI (32,768)	—	3936	32	40P, 44PT, 44ML	13x10-bit 100 ksps	2	3-16 bit, 2-8 bit, 1-WDT	2xEUSART, 2xMI ² C/SPI	48	8 MHz 32 kHz	PBOR/ LVD	3	0/2	✓	Peripheral remapping capability (cross bar), PMP
PIC18F63J90	8,192 StdFI (4,096)	—	1024	49	64PT	12x10-bit, 100 ksps	2	3-16 bit, 1-8 bit, 1-WDT	AUSART, EUSART, MI ² C/SPI	48	8 MHz 32 kHz	BOR/ LVD	3	2/0	✓	LCD: up to 128 segments

Abbreviations are found on the last page of the Selector Guide.

High-Performance 8-Bit PICmicro® Microcontroller Family (16-bit Instruction Set) (continued)																
Product	Program Memory: Bytes & Type (Words)	EEPROM Data Memory Bytes	RAM Bytes	I/O Pins	Packages	Analog		Digital		Max. Speed MHz	IntOSC	BOR/PBOR/PLVD/LVD	ICD # of Breakpoints	CCP/ECCP	nW	Other Features
PIC18FXXJXX: Flash and ROM MCUs: 10 MIPS, VDD = 2.0 - 3.6V, Self-Write Flash, Upwardly Compatible with PIC18/PIC16, 77 Instructions and C Compiler Efficient Instruction Set (continued)																
PIC18F64J90	16,384 StdFI (8,192)	—	1024	49	64PT	12x10-bit, 100 kspcs	2	3-16 bit, 1-8 bit, 1-WDT	AUSART, EUSART, MI ² C/SPI	40	8 MHz 32 kHz	BOR/LVD	3	2/0	✓	LCD: up to 128 segments
PIC18R65J10	32,768 ROM (16,384)	—	2048	50	64PT	11x10-bit, 100 kspcs	2	3-16 bit, 2-8 bit, 1-WDT	2xEUSART, 2xMI ² C/SPI	40	32 kHz	BOR	3	2/3	✓	PSP
PIC18F65J50	32,768 StdFI (16,384)	—	3936	49	64PT	8x10-bit, 100 kspcs	2	3-16 bit, 2-8 bit, 1-WDT	USB 2.0, 2xEUSART, 2xMI ² C/SPI	48	8 MHz 32 kHz	BOR	3	2/3	✓	Full-Speed USB 2.0 Compliant PMP
PIC18F65J90	32,768 StdFI (16,384)	—	2048	49	64PT	12x10-bit, 100 kspcs	2	3-16 bit, 1-8 bit, 1-WDT	AUSART, EUSART, MI ² C/SPI	40	8 MHz 32 kHz	BOR/LVD	3	2/0	✓	LCD: up to 128 segments
PIC18R66J10	65,536 ROM (32,768)	—	2048	50	64PT	11x10-bit, 100 kspcs	2	3-16 bit, 2-8 bit, 1-WDT	2xEUSART, 2xMI ² C/SPI	40	32 kHz	BOR	3	2/3	✓	PSP
PIC18F66J50	65,536 ROM (32,768)	—	3936	49	64PT	8x10-bit, 100 kspcs	2	3-16 bit, 2-8 bit, 1-WDT	USB 2.0, 2xEUSART, 2xMI ² C/SPI	48	8 MHz 32 kHz	BOR	3	2/3	✓	Full-Speed USB 2.0 Compliant PMP
PIC18R67J10	131,072 ROM (65,536)	—	3936	50	64PT	11x10-bit, 100 kspcs	2	3-16 bit, 2-8 bit, 1-WDT	2xEUSART, 2xMI ² C/SPI	40	32 kHz	BOR	3	2/3	✓	PSP
PIC18F67J50	131,072 StdFI (65,536)	—	3936	49	64PT	8x10-bit, 100 kspcs	2	3-16 bit, 2-8 bit, 1-WDT	USB 2.0, 2xEUSART, 2xMI ² C/SPI	48	8 MHz 32 kHz	BOR	3	2/3	✓	Full-Speed USB 2.0 Compliant PMP
PIC18F67J60	131,072 StdFI (65,536)	—	3808	39	64PT	11x10-bit, 100 kspcs	2	3-16 bit, 2-8 bit, 1-WDT	EUSART, MI ² C/SPI	42	32 kHz	BOR	3	2/3	✓	10Base-T Ethernet
PIC18F83J90	8,192 StdFI (4,096)	—	1024	64	80PT	12x10-bit, 100 kspcs	2	3-16 bit, 1-8 bit, 1-WDT	AUSART, EUSART, MI ² C/SPI	40	8 MHz 32 kHz	BOR/LVD	3	2/0	✓	LCD: up to 192 segments
PIC18F84J90	16,384 StdFI (8,192)	—	1024	64	80PT	12x10-bit, 100 kspcs	2	3-16 bit, 1-8 bit, 1-WDT	AUSART, EUSART, MI ² C/SPI	40	8 MHz 32 kHz	BOR/LVD	3	2/0	✓	LCD: up to 192 segments
PIC18R85J10	32,768 ROM (16,384)	—	2048	66	80PT	15x10-bit, 100 kspcs	2	3-16 bit, 2-8 bit, 1-WDT	2xEUSART, 2xMI ² C/SPI	40	32 kHz	BOR	3	2/3	✓	PSP, EMA
PIC18F85J50	32,768 StdFI (16,384)	—	3936	66	80PT	12x10-bit, 100 kspcs	2	3-16 bit, 2-8 bit, 1-WDT	USB 2.0, 2xEUSART, 2xMI ² C/SPI	48	8 MHz 32 kHz	BOR	3	2/3	✓	Full-Speed USB 2.0 Compliant PMP, EMA
PIC18F85J90	32,768 StdFI (16,384)	—	2048	64	80PT	12x10-bit, 100 kspcs	2	3-16 bit, 1-8 bit, 1-WDT	AUSART, EUSART, MI ² C/SPI	40	8 MHz 32 kHz	BOR/LVD	3	2/0	✓	LCD: up to 192 segments
PIC18R86J10	65,536 ROM (32,768)	—	2048	66	80PT	15x10-bit, 100 kspcs	2	3-16 bit, 2-8 bit, 1-WDT	2xEUSART, 2xMI ² C/SPI	40	32 kHz	BOR	3	2/3	✓	PSP, EMA
PIC18F86J50	65,536 StdFI (32,768)	—	3936	66	80PT	12x10-bit, 100 kspcs	2	3-16 bit, 2-8 bit, 1-WDT	USB 2.0, 2xEUSART, 2xMI ² C/SPI	48	8 MHz 32 kHz	BOR	3	2/3	✓	Full-Speed USB 2.0 Compliant PMP, EMA

Abbreviations are found on the last page of the Selector Guide.

High-Performance 8-Bit PICmicro® Microcontroller Family (16-bit Instruction Set) (continued)

Product	Program Memory: Bytes & Type (Words)	EEPROM Data Memory Bytes	RAM Bytes	I/O Pins	Packages	Analog	Digital	Max. Speed MHz	IntOSC	BOR/ PBOR/ PLVD/ LVD	ICD # of Breakpoints	CCP/ ECCP	nW	Other Features		
PIC18FXXJXX: Flash and ROM MCUs: 10 MIPS, V_{DD} = 2.0-3.6V, Self-Write Flash, Upwardly Compatible with PIC18/PIC16, 77 Instructions and C Compiler Efficient Instruction Set (continued)																
PIC18R87J10	131,072 ROM (65,536)	—	3936	66	80PT	15x10-bit, 100 ksps	2	3-16 bit, 2-8 bit, 1-WDT	2xEUSART, 2xMI ² C/SPI	40	32 kHz	BOR	3	2/3	✓	PSP, EMA
PIC18F87J50	131,072 StdFl (65,536)	—	3936	66	80PT	12x10-bit, 100 ksps	2	3-16 bit, 2-8 bit, 1-WDT	USB 2.0, 2xEUSART, 2xMI ² C/SPI	48	8 MHz 32 kHz	BOR	3	2/3	✓	Full-Speed USB 2.0 Compliant PMP, EMA
PIC18FXXKXX Flash MCUs: 16 MIPS, V_{DD} = 1.8 - 3.6V, Self-Write																
PIC18F25K20	32,768 EnhFl (16,384)	256	1536	25	28SP, 28SO, 28SS, 28ML	11x10 bit 100 ksps	2	3-16 bit, 1-8 bit, 1-WDT	EUSART, MI ² C/SPI	64	16 MHz 32 kHz	PBOR/ PLVD	3	1/1	✓	
PIC18F26K20	65,536 EnhFl (32,768)	1024	3968	25	28SP, 28SO, 28SS, 28ML	11x10 bit 100 ksps	2	3-16 bit, 1-8 bit, 1-WDT	EUSART, MI ² C/SPI	64	16 MHz 32 kHz	PBOR/ PLVD	3	1/1	✓	
PIC18F45K20	32,768 EnhFl (16,384)	256	1536	36	40P, 44ML, 44PT	14x10 bit 100 ksps	2	3-16 bit, 1-8 bit, 1-WDT	EUSART, MI ² C/SPI	64	16 MHz 32 kHz	PBOR/ PLVD	3	1/1	✓	PSP
PIC18F46K20	65,536 EnhFl (32,768)	1024	3968	36	40P, 44ML, 44PT	14x10 bit 100 ksps	2	3-16 bit, 1-8 bit, 1-WDT	EUSART, MI ² C/SPI	64	16 MHz 32 kHz	PBOR/ PLVD	3	1/1	✓	PSP

Abbreviations are found on the last page of the Selector Guide.

PIC24 16-Bit Microcontroller (MCU) Family

Product	Flash Program Memory (KBytes)	RAM (KBytes)	I/O Pins	Packages	Analog		Digital							ECAN™ Technology	IntOSC	Power On Reset	nW	Other Features
					ADC Ch	Comp.	Timers 16-bit	Input Cap	Output Comp/PWM	RTCC	UART w/ IrDA®	SPI™	I ² C™					
PIC24FJ Family 16-bit Flash MCUs: 16 MIPS, V_{DD} = 2.0 - 3.6V, Self-Write Flash																		
PIC24FJ32GA002	32	8	21	28P, 28SO, 28ML	13x10-bit 500 ksps	2	5	5	5	✓	2	2	2	—	8 MHz 32 kHz	✓	✓	Peripheral-to-Pin Map, PMP
PIC24FJ48GA002	48	8	21	28P, 28SO, 28ML	13x10-bit 500 ksps	2	5	5	5	✓	2	2	2	—	8 MHz 32 kHz	✓	✓	Peripheral-to-Pin Map, PMP
PIC24FJ64GA002	64	8	21	28P, 28SO, 28ML	13x10-bit 500 ksps	2	5	5	5	✓	2	2	2	—	8 MHz 32 kHz	✓	✓	Peripheral-to-Pin Map, PMP
PIC24FJ32GA004	32	8	35	44ML, 44PT	13x10-bit 500 ksps	2	5	5	5	✓	2	2	2	—	8 MHz 32 kHz	✓	✓	Peripheral-to-Pin Map, JTAG, PMP
PIC24FJ48GA004	48	8	35	44ML, 44PT	13x10-bit 500 ksps	2	5	5	5	✓	2	2	2	—	8 MHz 32 kHz	✓	✓	Peripheral-to-Pin Map, JTAG, PMP
PIC24FJ64GA004	64	8	35	44ML, 44PT	13x10-bit 500 ksps	2	5	5	5	✓	2	2	2	—	8 MHz 32 kHz	✓	✓	Peripheral-to-Pin Map, JTAG, PMP

Abbreviations are found on the last page of the Selector Guide.

PIC24 16-Bit Microcontroller (MCU) Family (continued)

Product	Flash Program Memory (KBytes)	RAM (KBytes)	I/O Pins	Packages	Analog		Digital							ECAN™ Technology	IntOSC	Power On Reset	nW	Other Features
					ADC Ch	Comp.	Timers 16-bit	Input Cap	Output Comp/PWM	RTCC	UART w/ IrDA®	SPI™	I²C™					
PIC24HJ Family 16-bit Flash MCUs: 40 MIPS, VDD = 3.0 - 3.6V, Self-Write Flash																		
PIC24HJ64GP506	64	8	53	64PT	18x12-bit 500 ksps	—	9	8	8	—	2	2	2	1	8 MHz 32 kHz	✓	✓	JTAG, DMA
PIC24HJ64GP510	64	8	85	100PT, 100PF	32x12-bit 500 ksps	—	9	8	8	—	2	2	2	1	8 MHz 32 kHz	✓	✓	JTAG, DMA
PIC24HJ128GP206	128	8	53	64PT	18x12-bit 500 ksps	—	9	8	8	—	2	2	1	—	8 MHz 32 kHz	✓	✓	JTAG, DMA
PIC24HJ128GP210	128	8	85	100PT, 100PF	32x12-bit 500 ksps	—	9	8	8	—	2	2	2	—	8 MHz 32 kHz	✓	✓	JTAG, DMA
PIC24HJ128GP506	128	8	53	64PT	18x12-bit 500 ksps	—	9	8	8	—	2	2	2	1	8 MHz 32 kHz	✓	✓	JTAG, DMA
PIC24HJ128GP510	128	8	85	100PT, 100PF	32x12-bit 500 ksps	—	9	8	8	—	2	2	2	1	8 MHz 32 kHz	✓	✓	JTAG, DMA
PIC24HJ128GP306	128	16	53	64PT	18x12-bit 500 ksps	—	9	8	8	—	2	2	2	—	8 MHz 32 kHz	✓	✓	JTAG, DMA
PIC24HJ128GP310	128	16	85	100PT	32x12-bit 500 ksps	—	9	8	8	—	2	2	2	—	8 MHz 32 kHz	✓	✓	JTAG, DMA
PIC24HJ256GP210	256	16	85	100PT, 100PF	32x12-bit 500 ksps	—	9	8	8	—	2	2	2	—	8 MHz 32 kHz	✓	✓	JTAG, DMA

Abbreviations are found on the last page of the Selector Guide.

MATURE – PICmicro[®] MICROCONTROLLER FAMILY PRODUCTS

The intent of this guide is to provide you with recommendations of newer products that may be more cost effective and/or have more features than some of our more mature products. This is not an end of life notice for these products.

Product	Program Memory (Bytes/Words)	Package Size	Recommended Design-In Device	Product	Program Memory (Bytes/Words)	Package Size	Recommended Design-In Device
PIC12C508	768/512x12	8	PIC12F508	PIC16C712	1,792/1,024x14	18	PIC16F716
PIC12C508A	768/512x12	8	PIC12F508	PIC16C715	3,584/2,048x14	18	PIC16F716
PIC12C509	1,536/1,024x12	8	PIC12F509	PIC16C716	3,584/2,048x14	18	PIC16F716
PIC12C509A	1,536/1,024x12	8	PIC12F509	PIC16C73A	7,168/4,096x14	28	PIC16F73
PIC12C671	1,536/1,024x14	8	PIC12F675	PIC16C73B	7,168/4,096x14	28	PIC16F73
PIC12C672	3,584/2,048x14	8	PIC12F683	PIC16C74A	7,168/4,096x14	40	PIC16F74
PIC12CE673	1,792/1,024x14	8	PIC12F675	PIC16C74B	7,168/4,096x14	40	PIC16F74
PIC12CE674	3,584/2,048x14	8	PIC12F683	PIC16C76	14,336/8,192x14	28	PIC16F76
PIC12CE518	768/512x12	8	PIC12F629	PIC16C77	14,336/8,192x14	40	PIC16F77
PIC12CE519	1,536/1,024x12	8	PIC12F629	PIC16C923	7,168/4,096x14	68	PIC16C925
PIC12CR509A	1,536/1,024x12	8	PIC12F509	PIC16C924	7,168/4,096x14	68	PIC16C925
PIC16C505	1,536/1,024x12	14	PIC16F505	PIC16CE623	896/512x14	18	PIC16F627A
PIC16C54	768/512x12	18	PIC16F54	PIC16CE624	1,792/1,024x14	18	PIC16F627A
PIC16C54A	768/512x12	18	PIC16F54	PIC16CE625	3,584/2,048x14	18	PIC16F628A
PIC16C54C	768/512x12	18	PIC16F54	PIC16CR54A	768/512x12	18	PIC16CR54C
PIC16C55	768/512x12	28	PIC16C55A	PIC16CR54C	768/512x12	18	PIC16F54
PIC16C56	1,536/1,024x12	18	PIC16C56A	PIC16CR57C	3,072/2,048x12	28	PIC16F57
PIC16C57	3,072/2,048x12	28	PIC16F57	PIC16CR83	896/512x14	18	PIC16F84A
PIC16C57C	3,072/2,048x12	28	PIC16F57	PIC16CR84	1,792/1,024x14	18	PIC16F84A
PIC16C62A	3,584/2,048x14	28	PIC16C62B or PIC16F72	PIC16F627	1,792/1,024x14	18	PIC16F627A
PIC16C620	896/2,048x14	18	PIC16C620A	PIC16F628	3,584/2,048x14	18	PIC16F628A
PIC16C621	1,792/1,024x14	18	PIC16C621A	PIC16F83	896/512x14	18	PIC16F84A
PIC16C622	3,584/2,048x14	18	PIC16C622A	PIC16F84	1,792/1,024x14	18	PIC16F84A
PIC16C63	7,168/4,096x14	28	PIC16C63B or PIC16F73	PIC16F873	7,168/4,096x14	28	PIC16F873A
PIC16C64A	3,584/2,048x14	40	PIC16F74	PIC16F874	7,168/4,096x14	28	PIC16F874A
PIC16C642	7,168/4,096x14	28	PIC16F72	PIC16F876	14,336/8,192x14	40	PIC16F876A
PIC16C65A	7,168/4,096x14	40	PIC16C65B or PIC16F74	PIC16F877	14,336/8,192x14	40	PIC16F877A
PIC16C66	1,4336/8,192x14	28	PIC16F76	PIC17C42A	4,096/2,048x16	40	PIC18F4220
PIC16C662	7,168/4,096x14	40	PIC16F74	PIC17C43	8,192/4,096x16	40	PIC18F4320
PIC16C67	14,336/8,192x14	40	PIC16F77	PIC17C44	16,384/8,192x16	40	PIC18F4420
PIC16C71	1,792/1,024x14	18	PIC16F716	PIC17C752	16,384/8,192x16	68	PIC18F6520
PIC16C72	3,584/2,048x14	28	PIC16F72	PIC17C756A	32,768/16,384x16	68	PIC18F6520
PIC16C72A	3,584/2,048x14	28	PIC16F72	PIC17C762	16,384/8,192x16	84	PIC18F8520
PIC16C710	896/512x14	18	PIC16F716	PIC17C766	32,768/16,384x16	84	PIC18F8520
PIC16C711	1,792/1,024x14	18	PIC16F716	PIC18C242	16,384/8,192x16	28	PIC18F2420

PICmicro® MCU FAMILY

Product	Program Memory (Bytes/Words)	Package Size	Recommended Design-In Device
PIC18C252	32,768/16,384x16	28	PIC18F2520
PIC18C442	16,384/8,192x16	40	PIC18F4420
PIC18C452	32,768/16,384x16	40	PIC18F4520
PIC18C658	32,768/16,384x16	68	PIC18F6585
PIC18C858	32,768/16,384x16	84	PIC18F8585
PIC18F242	16,384/8,192x16	28	PIC18F2420
PIC18F248	16,384/8,192x16	28	PIC18F2480
PIC18F252	32,768/16,384x16	28	PIC18F2520
PIC18F258	32,768/16,384x16	28	PIC18F2580
PIC18F442	16,384/8,192x16	40	PIC18F4420
PIC18F448	16,384/8,192x16	40	PIC18F4480
PIC18F452	32,768/16,384x16	40	PIC18F4520
PIC18F458	32,768/16,384x16	40	PIC18F4580
PIC18F2439	12,288/6,144x16	28	PIC18F2431
PIC18F2539	24,576/12,288x16	28	PIC18F2431

Product	Program Memory (Bytes/Words)	Package Size	Recommended Design-In Device
PIC18F4439	12,288/6,144x16	40	PIC18F4431
PIC18F4539	24,576/12,288x16	40	PIC18F4431
PIC18F6525	49,152/24,576x16	64	PIC18F6527
PIC18F6620	65,536/32,768x16	64	PIC18F6622
PIC18F6621	65,536/32,768x16	64	PIC18F6622
PIC18F6720	131,072/65,536x16	64	PIC18F6722
PIC18F8525	49,152/24,576x16	80	PIC18F8527
PIC18F8620	65,536/32,768x16	80	PIC18F8622
PIC18F8621	65,536/32,768x16	80	PIC18F8622
PIC18F8720	131,072/65,536x16	80	PIC18F8722

FOCUSED SOLUTIONS

CAN Solutions

Product	Program Memory Bytes & Type (Words)	EEPROM Data Memory Bytes	RAM Bytes	I/O Pins	Packages	Analog Peripherals	Digital Peripherals	Max. Speed MHz	ICD # of Breakpoints	Function-Specific Features					Development Boards
										ISO-16845 Tested	Transmit Buffers	Receive Buffers	Configurable RX/TX	Acceptance Filters/Mask	
PIC18F2480	16 KB EnhFI (8 KW)	256	768	25	28SP, 28SO, 28ML	ADC	EUSART, CCP	40	3	Planned	3	2	6	16/2	DM163011 PICDEM™ CAN-LIN 2
PIC18F2580	32 KB EnhFI (16 KW)	256	1536	25	28SP, 28SO, 28ML	ADC	EUSART, CCP	40	3	Planned	3	2	6	16/2	DM163011 PICDEM™ CAN-LIN 2
PIC18F2585	48 KB EnhFI (24 KW)	1024	3328	25	28SP, 28SO	ADC	EUSART, CCP	40	3	Planned	3	2	6	16/2	DM163011 PICDEM™ CAN-LIN 2
PIC18F2680	64 KB EnhFI (32 KW)	1024	3328	25	28SP, 28SO	ADC	EUSART, CCP	40	3	Planned	3	2	6	16/2	DM163011 PICDEM™ CAN-LIN 2
PIC18F2685*	96 KB EnhFI (48 KW)	1024	3328	25	28SP, 28SO	ADC	EUSART, CCP	40	3	Planned	3	2	6	16/2	DM163011 PICDEM™ CAN-LIN 2
PIC18F4480	16 KB EnhFI (8 KW)	256	768	36	40P, 44PT, 44ML	ADC/Comp	EUSART, CCP/ECCP	40	3	Planned	3	2	6	16/2	DM163011 PICDEM™ CAN-LIN 2
PIC18F4580	32 KB EnhFI (16 KW)	256	1536	36	40P, 44PT, 44ML	ADC/Comp	EUSART, CCP/ECCP	40	3	Planned	3	2	6	16/2	DM163011 PICDEM™ CAN-LIN 2
PIC18F4585	48 KB EnhFI (24 KW)	1024	3328	36	40P, 44PT, 44ML	ADC/Comp	EUSART, CCP/ECCP	40	3	Planned	3	2	6	16/2	DM163011 PICDEM™ CAN-LIN 2
PIC18F4680	64 KB EnhFI (32 KW)	1024	3328	36	40P, 44PT, 44ML	ADC/Comp	EUSART, CCP/ECCP	40	3	Planned	3	2	6	16/2	DM163011 PICDEM™ CAN-LIN 2
PIC18F4685*	96 KB EnhFI (48 KW)	1024	3328	36	40P, 44PT, 44ML	ADC/Comp	EUSART, CCP/ECCP	40	3	Planned	3	2	6	16/2	DM163011 PICDEM™ CAN-LIN 2
PIC18F6585	48 KB EnhFI (24 KW)	1024	3328	53	64PT, 68L	ADC/Comp	EUSART, CCP/ECCP	40	1	Yes	3	2	6	16/2	DM163015 PICDEM™ CAN-LIN 3
PIC18F6680	64 KB EnhFI (32 KW)	1024	3328	53	64PT, 68L	ADC/Comp	EUSART, CCP/ECCP	40	1	Yes	3	2	6	16/2	DM163015 PICDEM™ CAN-LIN 3
PIC18F8585	48 KB EnhFI (24 KW)	1024	3328	69	80PT	ADC/Comp	EUSART, CCP/ECCP	40	1	Yes	3	2	6	16/2	DM163015 PICDEM™ CAN-LIN 3
PIC18F8680	64 KB EnhFI (32 KW)	1024	3328	69	80PT	ADC/Comp	EUSART, CCP/ECCP	40	1	Yes	3	2	6	16/2	DM163015 PICDEM™ CAN-LIN 3
dsPIC30F4011	48 KB EnhFI (16 KW)	1024	2048	30	40P, 44PT, 44ML (8x8)	ADC	CAN, SPI, I ² C, 2xUART	120	1	Yes	3	2	0	4/2	DM300018 dsPICDEM™ 2
dsPIC30F4012	48 KB EnhFI (16 KW)	1024	2048	20	28SP, 28SO, 44ML (8x8)	ADC	CAN, SPI, I ² C, 2xUART	120	1	Yes	3	2	0	4/2	DM300018 dsPICDEM™ 2
dsPIC30F4013	48 KB EnhFI (16 KW)	1024	2048	30	40P, 44PT, 44ML (8x8)	ADC	CAN, SPI, I ² C, 2xUART	120	1	Yes	3	2	0	4/2	DM300018 dsPICDEM™ 2
dsPIC30F5011	66 KB EnhFI (22 KW)	1024	4096	52	64PT	ADC	2xCAN, 2xSPI, I ² C, 2xUART	120	2	Yes	3	2	0	4/2	DM300014 dsPICDEM™ 1.1
dsPIC30F5013	66 KB EnhFI (22 KW)	1024	4096	68	80PT	ADC	2xCAN, 2xSPI, I ² C, 2xUART	120	2	Yes	3	2	0	4/2	DM300014 dsPICDEM™ 1.1
dsPIC30F5015	66 KB EnhFI (22 KW)	1024	2048	52	64PT	ADC	CAN, UART, 2xSPI, I ² C	120	2	Yes	3	2	0	4/2	DM300020
dsPIC30F5016	66 KB EnhFI (22 KW)	1024	2048	68	80PT	ADC	CAN, UART, 2xSPI, I ² C	120	2	Yes	3	2	0	4/2	DM300020
dsPIC30F6010	144 KB EnhFI (48 KW)	4096	8192	68	80PF	ADC	2xCAN, 2xSPI, I ² C, 2xUART	120	2	Yes	3	2	0	4/2	DM300020

* Contact Microchip Technology Inc. for availability.
Refer to Connectivity Design Center on www.microchip.com/can for further details.
Abbreviations are found on the last page of the Selector Guide.

CAN Solutions (continued)

	Product	Program Memory Bytes & Type (Words)	EEPROM Data Memory Bytes	RAM Bytes	I/O Pins	Packages	Analog Peripherals	Digital Peripherals	Max. Speed MHz	ICD # of Breakpoints	Function-Specific Features					Development Boards
											ISO-16845 Tested	Transmit Buffers	Receive Buffers	Configurable RX/TX	Acceptance Filters/Mask	
NEW	dsPIC30F6010A	144 KB EnhFl (48 KW)	4096	8192	68	80PF, 80PT	ADC	2xCAN, 2xSPI, I ² C, 2xUART	120	2	Yes	3	2	0	4/2	DM300020
	dsPIC30F6011	132 KB EnhFl (44 KW)	2048	6144	52	64PF	ADC	2xCAN, 2xSPI, I ² C, 2xUART	120	2	Yes	3	2	0	4/2	DM300014 dsPICDEM™ 1.1
NEW	dsPIC30F6011A	132 KB EnhFl (44 KW)	2048	6144	52	64PF, 64PT	ADC	2xCAN, 2xSPI, I ² C, 2xUART	120	2	Yes	3	2	0	4/2	DM300014 dsPICDEM™ 1.1
	dsPIC30F6012	144 KB EnhFl (48 KW)	4096	8192	52	64PF	ADC	2xCAN, 2xSPI, I ² C, 2xUART	120	2	Yes	3	2	0	4/2	DM300014 dsPICDEM™ 1.1
NEW	dsPIC30F6012A	144 KB EnhFl (48 KW)	4096	8192	52	64PF, 64PT	ADC	2xCAN, 2xSPI, I ² C, 2xUART	120	2	Yes	3	2	0	4/2	DM300014 dsPICDEM™ 1.1
	dsPIC30F6013	132 KB EnhFl (44 KW)	2048	6144	68	80PF	ADC	2xCAN, 2xSPI, I ² C, 2xUART	120	2	Yes	3	2	0	4/2	DM300014 dsPICDEM™ 1.1
NEW	dsPIC30F6013A	132 KB EnhFl (44 KW)	2048	6144	68	80PF, 80PT	ADC	2xCAN, 2xSPI, I ² C, 2xUART	120	2	Yes	3	2	0	4/2	DM300014 dsPICDEM™ 1.1
	dsPIC30F6014	144 KB EnhFl (48 KW)	4096	8192	68	80PF	ADC	2xCAN, 2xSPI, I ² C, 2xUART	120	2	Yes	3	2	0	4/2	DM300014 dsPICDEM™ 1.1
NEW	dsPIC30F6014A	144 KB EnhFl (48 KW)	4096	8192	68	80PF, 80PT	ADC	2xCAN, 2xSPI, I ² C, 2xUART	120	2	Yes	3	2	0	4/2	
NEW	dsPIC33FJ64MC508*	64 KB EnhFl (21 KW)	—	8192	69	80PT	ADC	1xECAN, 2xI ² C 2xUART, 2xSPI	160	4	Planned	8 max	16 max	8	16/3	
NEW	dsPIC33FJ64MC706*	64 KB EnhFL (21 KW)	—	16K	53	64PT	ADC	1xECAN, 2xI ² C 2xUART, 2xSPI	160	4	Planned	8 max	16 max	8	16/3	
NEW	dsPIC33FJ64MC710*	64 KB EnhFl (21 KW)	—	16K	53	100PT, 100PF	ADC	2xECAN, 2xI ² C 2xUART, 2xSPI	160	4	Planned	16 max	32 max	16	32/6	
NEW	dsPIC33FJ128MC706*	128 KB EnhFl (43 KW)	—	16K	53	64PT	ADC	1xECAN, 2xI ² C 2xUART, 2xSPI	160	4	Planned	8 max	16 max	8	16/3	
NEW	dsPIC33FJ128MC708*	128 KB EnhFl (43 KW)	—	16K	69	80PT	ADC	2xECAN, 2xI ² C 2xUART, 2xSPI	160	4	Planned	16 max	32 max	16	32/6	
NEW	dsPIC33FJ256MC710*	256 KB EnhFl (85 KW)	—	30K	85	100PT, 100PF	ADC	2xECAN, 2xI ² C 2xUART, 2xSPI	160	4	Planned	16 max	32 max	16	32/6	
NEW	dsPIC33FJ64GP706*	64 KB EnhFl (21 KW)	—	16K	53	64PT	ADC	2xECAN, 2xI ² C 2xUART, 2xSPI	160	4	Planned	16 max	32 max	16	32/6	
NEW	dsPIC33FJ64GP708*	64 KB EnhFl (21 KW)	—	16K	69	80PT	ADC	2xECAN, 2xI ² C 2xUART, 2xSPI	160	4	Planned	16 max	32 max	16	32/6	
NEW	dsPIC33FJ64GP710*	64 KB EnhFl (21 KW)	—	16K	85	100PT, 100PF	ADC	2xECAN, 2xI ² C 2xUART, 2xSPI	160	4	Planned	16 max	32 max	16	32/6	
NEW	dsPIC33FJ128GP708*	128 KB EnhFl (43 KW)	—	16K	69	80PT	ADC	2xECAN, 2xI ² C 2xUART, 2xSPI	160	4	Planned	16 max	32 max	16	32/6	
NEW	dsPIC33FJ256GP506*	256 KB EnhFl (85 KW)	—	16K	53	64PT	ADC	1xECAN, 2xI ² C 2xUART, 2xSPI	160	4	Planned	8 max	16 max	8	16/3	
NEW	dsPIC33FJ256GP710*	256 KB EnhFl (85 KW)	—	30K	85	100PT, 100PF	ADC	2xECAN, 2xI ² C 2xUART, 2xSPI	160	4	Planned	16 max	32 max	16	32/6	

* Contact Microchip Technology Inc. for availability.
Refer to Connectivity Design Center on www.microchip.com/can for further details.
Abbreviations are found on the last page of the Selector Guide.

CAN Solutions (continued)

Product	Program Memory Bytes & Type (Words)	EEPROM Data Memory Bytes	RAM Bytes	I/O Pins	Packages	Analog Peripherals	Digital Peripherals	Max. Speed MHz	ICD # of Breakpoints	Function-Specific Features					Development Boards
										ISO-16845 Tested	Transmit Buffers	Receive Buffers	Configurable RX/TX	Acceptance Filters/Mask	
PIC24HJ256GP610*	256 KB EnhFI (85 KW)	—	16K	85	100PT, 100PF	ADC	2xECAN, 2xI ² C 2xUART, 2xSPI	160	4	Planned	16 max	32 max	16	32/6	

NEW

* Contact Microchip Technology Inc. for availability.
Refer to Connectivity Design Center on www.microchip.com/can for further details.
Abbreviations are found on the last page of the Selector Guide.

CAN Peripherals/Transceivers

Part #	Operating Voltage (V)	Temperature Range (°C)	Tx Buffers	Rx Buffers	Filters	Masks	Interrupt Output	Unique Features	Packages
MCP2515	2.7 to 5.5	-40 to +125	3	2	6	2	Yes	MCP2510 pin compatible upgrade with enhanced features including higher throughput and data byte filtering	18-Pin PDIP, 18-Pin SOIC, 20-Pin TSSOP
MCP25020	2.7 to 5.5	-40 to +125	3	2	2	1	N/A	CAN 2.0B Active I/O Expander. See "Interface Section" of the Analog/Interface Family Products.	14-Pin PDIP, 14-Pin SOIC
MCP25025	2.7 to 5.5	-40 to +85	3	2	2	1	N/A	CAN 2.0B Active I/O Expander. See "Interface Section" of the Analog/Interface Family Products.	14-Pin PDIP, 14-Pin SOIC
MCP25050	2.7 to 5.5	-40 to +125	3	2	2	1	N/A	CAN 2.0B Active I/O Expander. See "Interface Section" of the Analog/Interface Family Products.	14-Pin PDIP, 14-Pin SOIC
MCP25055	2.7 to 5.5	-40 to +85	3	2	2	1	N/A	CAN 2.0B Active I/O Expander. See "Interface Section" of the Analog/Interface Family Products.	14-Pin PDIP, 14-Pin SOIC
MCP2551	4.5 to 5.5	-40 to +125	n/a	n/a	n/a	n/a	N/A	CAN 2.0B Active I/O Expander. See "Interface Section" of the Analog/Interface Family Products.	8-Pin PDIP, 8-Pin SOIC

Ethernet Solutions – Integrated

	Product	Program Memory Bytes & Type (Words)	RAM Bytes	I/O Pins	Packages	Analog Peripherals	Digital Peripherals	Max. Speed MHz	ICD # of Breakpoints	Function-Specific Features					Development Boards
										IEEE.802.3 Compliant	MAC	PHY	TX/RX Buffer (bytes)	Ethernet Voltage Range (V)	
NEW	PIC18F66J60*	16,384 EnhFI (8,192)	2048	39	64PT	ADC/Comp	EUSART, CCP/ECCP	42	3	Yes	Yes	10 Base-T	8192	3.14 to 3.45	
NEW	PIC18F66J65*	32,768 EnhFI (16,384)	3808	39	64PT	ADC/Comp	EUSART, CCP/ECCP	42	3	Yes	Yes	10 Base-T	8192	3.14 to 3.45	
NEW	PIC18F67J60*	49,152 EnhFI (24,576)	3808	39	64PT	ADC/Comp	EUSART, CCP/ECCP	42	3	Yes	Yes	10 Base-T	8192	3.14 to 3.45	
NEW	PIC18F86J60*	65,536 EnhFI (32,768)	2048	55	80PT	ADC/Comp	EUSART, CCP/ECCP	42	3	Yes	Yes	10 Base-T	8192	3.14 to 3.45	
NEW	PIC18F86J65*	16,384 EnhFI (8,192)	3808	55	80PT	ADC/Comp	EUSART, CCP/ECCP	42	3	Yes	Yes	10 Base-T	8192	3.14 to 3.45	
NEW	PIC18F87J60*	32,768 EnhFI (16,384)	3808	55	80PT	ADC/Comp	EUSART, CCP/ECCP	42	3	Yes	Yes	10 Base-T	8192	3.14 to 3.45	
NEW	PIC18F96J60*	49,152 EnhFI (24,576)	3808	70	100PT	ADC/Comp	EUSART, CCP/ECCP	42	3	Yes	Yes	10 Base-T	8192	3.14 to 3.45	
NEW	PIC18F96J65*	65,536 EnhFI (32,768)	3808	70	100PT	ADC/Comp	EUSART, CCP/ECCP	42	3	Yes	Yes	10 Base-T	8192	3.14 to 3.45	
NEW	PIC18F97J60*	49,152 EnhFI (24,576)	3808	70	100PT	ADC/Comp	EUSART, CCP/ECCP	42	3	Yes	Yes	10 Base-T	8192	3.14 to 3.45	

Abbreviations are found on the last page of the Selector Guide.

Ethernet Solutions – Stand-Alone

Product	Interrupts	Package	LEDs	Serial	Max Speed (MHz)	Features	Function-Specific Features					Development Boards
							IEEE.802.3 Compliant	MAC	PHY	TX/RX Buffer (bytes)	Ethernet Voltage Range (V)	
ENC28J60	2	28SO, 28SS, 28ML	2	SPI™	25	Loop-back test modes, auto polarity	Yes	Yes	10 Base-T	8192	3.14 to 3.45	

NEW Abbreviations are found on the last page of the Selector Guide.

USB Solutions

Product	Program Memory Bytes & Type (Words)	EEPROM Data Memory Bytes	RAM Bytes	I/O Pins	Packages	Analog Peripherals	Digital Peripherals	Max. Speed MHz	ICD # of Breakpoints	Function-Specific Features					Development Boards
										Compliant	Speed	# of Endpoints	USB Buffer (bytes)	Streaming Port	
PIC16C745	14,336 OTP (8,192)	—	256	22	28SP, 28SO, 28JW	ADC	UART	24	—	USB 1.1	Low-Speed (1.5 Mbit/s)	16	64	—	DM163010 PICDEM™ USB
PIC16C765	14,336 OTP (8,192)	—	256	33	40P, 40JW, 44L, 44PT	ADC	UART	24	—	USB 1.1	Low-Speed (1.5 Mbit/s)	16	64	—	DM163010 PICDEM™ USB
PIC18F2450*	16,384 EnhFI (8,192)	—	768	23	28SP, 28SO, 28ML	ADC/Comp	USB 2.0, AUSART	48	3	USB 2.0	Full-Speed (12 Mbit/s)	16	256	—	DM163025 PICDEM™ FS-USB
PIC18F2455	24,576 EnhFI (12,288)	256	2048	24	28SP, 28SO	ADC/Comp	EUSART, MI ² C/SPI	48	3	USB 2.0	Full-Speed (12 Mbit/s)	16	1024	—	DM163025 PICDEM™ FS-USB

*Contact Microchip Technology Inc. for availability. Refer to Connectivity Design Center on www.microchip.com/usb for further details. Abbreviations are found on the last page of the Selector Guide.

USB Solutions (continued)

Product	Program Memory Bytes & Type (Words)	EEPROM Data Memory Bytes	RAM Bytes	I/O Pins	Packages	Analog Peripherals	Digital Peripherals	Max. Speed MHz	ICD # of Breakpoints	Function-Specific Features					Development Boards
										Compliant	Speed	# of Endpoints	USB Buffer (bytes)	Streaming Port	
PIC18F2550	32,768 EnhFI (16,384)	256	2048	24	28SP, 28SO	ADC/Comp	EUSART, MI ² C/SPI	48	3	USB 2.0	Full-Speed (12 Mbit/s)	16	1024	—	DM163025 PICDEM™ FS-USB
PIC18F4450*	16,384 EnhFI (8183)	—	768	34	40P, 44ML, 44PT	ADC/Comp	USB 2.0, AUSART	48	3	USB 2.0	Full-Speed (12 Mbit/s)	16	256	—	DM163025 PICDEM™ FS-USB
PIC18F4455	24,576 EnhFI (12,288)	256	2048	36	40P, 44PT, 44ML	ADC/Comp	EUSART, MI ² C/SPI	48	3	USB 2.0	Full-Speed (12 Mbit/s)	16	1024	✓	DM163025 PICDEM™ FS-USB
PIC18F4550	32,768 EnhFI (16,384)	256	2048	36	40P, 44PT, 44ML	ADC/Comp	EUSART, MI ² C/SPI	48	3	USB 2.0	Full-Speed (12 Mbit/s)	16	1024	✓	DM163025 PICDEM™ FS-USB
PIC18F65J50*	32,768 StdFI (16,384)	—	3936	50	64PT	ADC/Comp	USB 2.0, 2xEUSART, 2xMI ² C/SPI	48	3	USB 2.0	Full-Speed (12 Mbit/s)	16	1024	—	
NEW PIC18F66J50*	65,536 StdFI (32,768)	—	3936	50	64PT	ADC/Comp	USB 2.0, 2xEUSART, 2xMI ² C/SPI	48	3	USB 2.0	Full-Speed (12 Mbit/s)	16	1024	—	
NEW PIC18F67J50*	131,072 StdFI (65,536)	—	3936	50	64PT	ADC/Comp	USB 2.0, 2xEUSART, 2xMI ² C/SPI	48	3	USB 2.0	Full-Speed (12 Mbit/s)	16	1024	—	
NEW PIC18F85J50*	32,768 StdFI (16,384)	—	3936	66	80PT	ADC/Comp	USB 2.0, 2xEUSART, 2xMI ² C/SPI	48	3	USB 2.0	Full-Speed (12 Mbit/s)	16	1024	—	
NEW PIC18F86J50*	65,536 StdFI (32,768)	—	3936	66	80PT	ADC/Comp	USB 2.0, 2xEUSART, 2xMI ² C/SPI	48	3	USB 2.0	Full-Speed (12 Mbit/s)	16	1024	—	
NEW PIC18F87J50*	131,072 StdFI (65,536)	—	3936	66	80PT	ADC/Comp	USB 2.0, 2xEUSART, 2xMI ² C/SPI	48	3	USB 2.0	Full-Speed (12 Mbit/s)	16	1024	—	

*Contact Microchip Technology Inc. for availability.
Refer to Connectivity Design Center on www.microchip.com/usb for further details.
Abbreviations are found on the last page of the Selector Guide.

USB Battery Chargers

Part #	Mode	Cell Type	# of Cells	Vcc Range (V)	Max. Voltage Regulation (%)	Int/Ext FET	Features	Packages
MCP73853	Linear	Li-Ion/Li-Polymer	1	4.5 to 5.5	±0.5	Int	USB control, Safety charge timers, Temperature monitor, Thermal regulation	16-Pin QFN (4x4)
MCP73855	Linear	Li-Ion/Li-Polymer	1	4.5 to 5.5	±0.5	Int	USB control, Safety charge timers, Thermal regulation	10-Pin DFN (3x3)

Switching Battery Chargers

Product	Mode	Cell Type	# of Cells	Vin Range (V)	Max. Voltage Regulation (%)	Int/Ext FET	Features	Package
PS200*	Switch	Li-Ion / Li-Polymer	1-4	5-18	±1%	Ext	Voltage and current regulation, safety charge timers and temperature limits, internal voltage regulator, 500 kHz (max.) PWM	20-Pin PDIP, SOIC, SSOP

* Contact Microchip Technology for availability.

Battery Fuel Gauge ICs

Product	Battery Chemistry	# of Cells	Interface	Data Set	A/D Converter	Programmable Memory	Programmable I/O Functions	Accuracy	Time Base	Temp. Sensor	Packaging	Description
PS501	Li-Ion NiMH	2-4 6-12	SMBus	> 1%	16-bit Sigma-Delta	16 Kbytes Flash, 256 bytes EEPROM	12 GPIO	-	On-chip	On-chip external	28-pin SSOP	Single chip field reprogrammable battery manager IC reports capacity, current, temperature, voltage and other status for Li-Ion or Nickel batteries.
PS810	Li-Ion	1	SMBus/SI	-	16-bit Sigma-Delta	4k x 16 Flash	6 GPIO	1%	On-chip	On-chip	14-pin TSSOP, 16-pin QFN	Single cell Li-Ion fuel gauge provides battery status such as run time to empty, run time to full, relative state-of-charge and battery state-of-health.

Radio Frequency Solutions

Product	Program Memory Bytes & Type (Words)	EEPROM Data Memory Bytes	RAM Bytes	I/O Pins	Packages	Analog Peripherals	Digital Peripherals	Max. Speed (MHz)	Function-Specific Specifications					Development Boards
									Modulation	Data Rate (kbps)	Output Power (dBm)	Operating Voltage (V)	Frequency Range (MHz)	
rfPIC® Microcontrollers with UHF RF Transmitter, ICSP™														
rfPIC12C509AF	1,536 OTP (1,024)	—	41	6	20JW, 20SS	—	1-8 bit Timer, WDT	4	FSK, ASK	40	2	2.5-5.5	310-440	
rfPIC12C509AG	1,536 OTP (1,024)	—	41	6	18JW, 18SO	—	1-8 bit Timer, WDT	4	ASK	40	2	2.5-5.5	310-440	
rfPIC12F675F	1,792 StdFI (1,024)	128	64	6	20SS	4x10-bit A/D, Comp	1-8 bit, 1-16 bit Timer, WDT	20	FSK, ASK	40	10	2.0-5.5	380-450	DV164102 rfPIC® Development Kit
rfPIC12F675H	1,792 StdFI (1,024)	128	64	6	20SS	4x10-bit A/D, Comp	1-8 bit, 1-16 bit Timer, WDT	20	FSK, ASK	40	10	2.0-5.5	850-930	DV164102 rfPIC® Development Kit
rfPIC12F675K	1,792 StdFI (1,024)	128	64	6	20SS	4x10-bit A/D, Comp	1-8 bit, 1-16 bit Timer, WDT	20	FSK, ASK	40	10	2.0-5.5	290-350	DV164102 rfPIC® Development Kit

Product	Transmission Code Length Bits	Code Hopping Bits	Programmable Encryption Key Bits	Packages	Protocols	Function Codes	Tunable OSC	CRC	Function-Specific Specifications				Development Boards
									Modulation	Output Power (dBm)	Operating Voltage (V)	Frequency Range (MHz)	
rfHCS KEELoq® Encoders with UHF RF Transmitter													
rfHCS362F	69	32	2 x 64	20SS	PWM, Manchester	4 x 15	✓	✓	FSK, ASK	2	2.2-5.5	310-440	DM303006 KEELoq® Evaluation Kit II
rfHCS362G	69	32	2 x 64	18SO	PWM, Manchester	4 x 15	✓	✓	ASK	2	2.2-5.5	310-440	DM303006 KEELoq® Evaluation Kit II

Product	Modulation	Data Rate (kbps)	Frequency Range (MHz)	Sensitivity dBm (FSK)	IF Frequency Range (MHz)	Operating Voltage (V)	Package	Development Boards
UHF RF Receiver								
rRXD0420	ASK, FSK, FM	80	300-450	-111	0.455-21.4	2.5-5.5	32LQ	DV164102 rPIC® Development Kit
rRXD0920	ASK, FSK, FM	80	800-930	-109	0.455-21.4	2.5-5.5	32LQ	DV164102 rPIC® Development Kit

Refer to Design pages on www.microchip.com for further details.
Abbreviations are found on the last page of the Selector Guide.

Product	Carrier Frequency	Programming	Anticollision	Memory Type	Memory Size	Protocols	Packages	Other
micro1D® RFID Tagging Devices								
MCRF355	13.56 MHz	Contact/Factory	Yes	R/W	154 bits	ASK Manchester	W, WF, S, P, SN	–
MCRF360	13.56 MHz	Contact/Factory	Yes	R/W	154 bits	ASK Manchester	W, WF, S, P, SN	100 pF res cap
MCRF450	13.56 MHz	Contactless	Yes	R/W	1 Kbit	PPM, ASK Manchester	W, WF, S, P, SN	32-bit unique ID user lock control by block
MCRF452	13.56 MHz	Contactless	Yes	R/W	1 Kbit	PPM, ASK Manchester	W, WF, S, P, SN	Dual 50 pF res cap

LCD Solutions

Product	Program Memory Bytes & Type (Words)	EEPROM Data Memory Bytes	RAM Bytes	I/O Pins	Packages	Analog Peripherals	Digital Peripherals	Max. Speed MHz	ICD # of Breakpoints	LCD Function-Specific Features					Development Boards
										COMxSegment = # Segments	Drive in Sleep	Software Configurable Driver Pins	Direct Drive	Intl. Charge Pump	
PIC16C925	7,168 OTP (4,096)	—	176	52	64PT, 68CL, 68L	ADC	I ² C/SPI	20	—	4x29 (116)	Yes	No	Yes	Yes	DM163003 PICDEM™ 3 LCD
PIC16C926	14,336 OTP (8,192)	—	336	52	64PT, 68CL, 68L	ADC	I ² C/SPI	20	—	4x29 (116)	Yes	No	Yes	Yes	DM163003 PICDEM™ 3 LCD
NEW PIC16F913	7,168 StdFI (4,096)	256	256	25	28P, 28SO, 28SS, 28ML	ADC/Comp	AUSART, I ² C/SPI	20	1	4x15 (60)	Yes	Yes	Yes	No	DS163028 PICDEM™ LCD
NEW PIC16F914	7,168 StdFI (4,096)	256	256	36	40P, 44PT, 44ML	ADC/Comp	AUSART, I ² C/SPI	20	1	4x24 (96)	Yes	Yes	Yes	No	DS163028 PICDEM™ LCD
NEW PIC16F916	14,336 StdFI (8,192)	256	352	25	28P, 28SO, 28SS, 28ML	ADC/Comp	AUSART, I ² C/SPI	20	1	4x15 (60)	Yes	Yes	Yes	No	DS163028 PICDEM™ LCD
NEW PIC16F917	14,336 StdFI (8,192)	256	352	36	40P, 44PT, 44ML	ADC/Comp	AUSART, I ² C/SPI	20	1	4x24 (96)	Yes	Yes	Yes	No	DS163028 PICDEM™ LCD
NEW PIC16F946	14,336 StdFI (8,192)	256	336	53	64PT	ADC/Comp	AUSART, I ² C/SPI	20	1	4x42 (168)	Yes	Yes	Yes	No	DS163028 PICDEM™ LCD
PIC18F6390	8,192 StdFI (4,096)	—	768	50	64PT	ADC/Comp	EUSART, AUSART, MI ² C/SPI	40	3	4x32 (128)	Yes	Yes	Yes	No	DM163028 PICDEM™ LCD
NEW PIC18F63J90*	8,192 StdFI (4,096)	—	1024	49	64PT	ADC/Comp	EUSART, AUSART, MI ² C/SPI	40	3	4x32 (128)	Yes	Yes	Yes	Yes	
PIC18F6490	16,384 StdFI (8,192)	—	768	50	64PT	ADC/Comp	EUSART, AUSART, MI ² C/SPI	40	3	4x32 (128)	Yes	Yes	Yes	No	DM163028 PICDEM™ LCD

*Contact Microchip Technology Inc. for availability.
Refer to LCD Design Center on www.microchip.com/lcd for further details.
Abbreviations are found on the last page of the Selector Guide.

LCD Solutions (continued)															
Product	Program Memory Bytes & Type (Words)	EEPROM Data Memory Bytes	RAM Bytes	I/O Pins	Packages	Analog Peripherals	Digital Peripherals	Max. Speed MHz	ICD # of Breakpoints	LCD Function-Specific Features					Development Boards
										COMxSegment = # Segments	Drive in Sleep	Software Configurable Driver Pins	Direct Drive	Intl. Charge Pump	
PIC18LF6493*	16,384 StdFI (8,192)	—	768	50	64PT	ADC (12-bit)/Comp	EUSART, AUSART, MI ² C/SPI	40	3	4x32 (128)	Yes	Yes	Yes	No	DM163028 PICDEM™ LCD
NEW PIC18F64J90*	16,384 StdFI (8,192)	—	1024	49	64PT	ADC/Comp	EUSART, AUSART, MI ² C/SPI	40	3	4x32 (128)	Yes	Yes	Yes	Yes	
NEW PIC18F65J90*	32,768 StdFI (16,384)	—	2048	49	64PT	ADC/Comp	EUSART, AUSART, MI ² C/SPI	40	3	4x32 (128)	Yes	Yes	Yes	Yes	
PIC18F8390	8,192 StdFI (4,096)	—	768	66	80PT	ADC/Comp	EUSART, AUSART, MI ² C/SPI	40	3	4x48 (192)	Yes	Yes	Yes	No	DM163028 PICDEM™ LCD
NEW PIC18F83J90*	8,192 StdFI (4,096)	—	1024	65	80PT	ADC/Comp	EUSART, AUSART, MI ² C/SPI	40	3	4x48 (192)	Yes	Yes	Yes	Yes	
PIC18F8490	16,384 StdFI (8,192)	—	768	66	80PT	ADC/Comp	EUSART, AUSART, MI ² C/SPI	40	3	4x48 (128)	Yes	Yes	Yes	No	DM163028 PICDEM™ LCD
PIC18LF8493*	16,384 StdFI (8,192)	—	768	66	80PT	ADC (12-bit)/Comp	EUSART, AUSART, MI ² C/SPI	40	3	4x48 (192)	Yes	Yes	Yes	No	DM163028 PICDEM™ LCD
NEW PIC18F84J90*	16,384 StdFI (8,192)	—	1024	65	80PT	ADC/Comp	EUSART, AUSART, MI ² C/SPI	40	3	4x48 (192)	Yes	Yes	Yes	Yes	
NEW PIC18F85J90*	32,768 StdFI (16,384)	—	2048	65	80PT	ADC/Comp	EUSART, AUSART, MI ² C/SPI	40	3	4x48 (192)	Yes	Yes	Yes	Yes	

*Contact Microchip Technology Inc. for availability.
Refer to LCD Design Center on www.microchip.com/lcd for further details.
Abbreviations are found on the last page of the Selector Guide.

Display Solutions									
Part #	Display Type	Supply Voltage (V)	Resolution (Digits)	Resolution (Counts)	Power (mW)	Temp. Range (°C)	Features	Packages	
TC820	LCD	9	3¾	±4,000	10	0 to +70	DMM plus frequency counter and logic probe	40-Pin PDIP, 44-Pin PLCC, 44-Pin MQFP	
TC7106	LCD	9	3½	±2,000	10	-25 to +85	For DMM, DPM, Data logger applications	40-Pin PDIP, 44-Pin PLCC, 44-Pin MQFP, 40-Pin CerDIP	
TC7106A	LCD	9	3½	±2,000	10	-25 to +85	For DMM, DPM, Data logger applications	40-Pin PDIP, 44-Pin PLCC, 44-Pin MQFP, 40-Pin CerDIP	
TC7116	LCD	9	3½	±2,000	10	-25 to +85	Hold function	40-Pin PDIP, 44-Pin PLCC, 44-Pin MQFP, 40-Pin CerDIP	
TC7116A	LCD	9	3½	±2,000	10	-25 to +85	Hold function	40-Pin PDIP, 44-Pin PLCC, 44-Pin MQFP, 40-Pin CerDIP	
TC7126	LCD	9	3½	±2,000	0.5	-25 to +85	Low-power TC7106	40-Pin PDIP, 44-Pin PLCC, 44-Pin MQFP, 40-Pin CerDIP	

Display Solutions (continued)

Part #	Display Type	Supply Voltage (V)	Resolution (Digits)	Resolution (Counts)	Power (mW)	Temp. Range (°C)	Features	Packages
TC7126A	LCD	9	3½	±2,000	0.5	-25 to +85	Low-power TC7106	40-Pin PDIP, 44-Pin PLCC, 44-Pin MQFP, 40-Pin CerDIP
TC7129	LCD	9	4½	±20,000	4.5	0 to +70	Lowest noise ±3 mV sensitivity	40-Pin PDIP, 44-Pin PLCC, 44-Pin MQFP

Motor Control Solutions

Product	Program Memory Bytes & Type (Words)	EEPROM Data Memory Bytes	RAM Bytes	I/O Pins	Packages	Analog Peripherals	Digital Peripherals	Max. Speed MHz	ICD # of Breakpoints	Function-Specific Features					Development Boards
										Timers	Input Capture	Output Comp/Std PWM	Motor Control PWM	Quadrature Encoder	
PIC12F683	3,584 StdFI (2,048)	256	128	6	8P, 8SN, 8MF	ADC/Comp	—	20	1	1-16 bit, 2-8 bit, WDT	1	1x10 bit	—	—	PICKIT™ 1
PIC16F684	3,584 EnhFI (2,048)	256	128	12	14P, 14SL, 14ST	ADC/Comp	—	20	1	1-16 bit, 2-8 bit, WDT	1	4x10 bit	—	—	PICKIT™ 1
PIC16F716	3,584 StdFI (2,048)	—	128	13	18P, 18SO, 20SS	ADC	—	20	1	1-16 bit, 2-8 bit, WDT	1	4x10 bit	—	—	DM163022 PICDEM™ 2 Plus
PIC16F737	7,168 StdFI (4,096)	—	368	25	28SP, 28SO, 28SS, 28ML	ADC/Comp	USART, I ² C/SPI	20	1	1-16 bit, 2-8 bit, WDT	3	3x10 bit	—	—	DM163022 PICDEM™ 2 Plus
PIC16F747	7,168 StdFI (4,096)	—	368	36	40P, 44PT, 44ML	ADC/Comp	USART, I ² C/SPI	20	1	1-16 bit, 2-8 bit, WDT	3	3x10 bit	—	—	DM163022 PICDEM™ 2 Plus
PIC16F767	14,336 StdFI (8,192)	—	368	25	28SP, 28SO, 28SS, 28ML	ADC/Comp	USART, I ² C/SPI	20	1	1-16 bit, 2-8 bit, WDT	3	3x10 bit	—	—	DM163022 PICDEM™ 2 Plus
PIC16F777	14,336 StdFI (8,192)	—	368	36	40P, 44PT, 44ML	ADC/Comp	USART, I ² C/SPI	20	1	1-16 bit, 2-8 bit, WDT	3	3x10 bit	—	—	DM163022 PICDEM™ 2 Plus
PIC18F1230*	4,096 EnhFI (2048)	128	256	16	18P, 18SO, 20SS, 28ML	ADC/Comp	EUSART	40	3	2-16 bit, 1-WDT	—	—	6	—	
PIC18F1330*	8,192 EnhFI (4,096)	128	256	16	18P, 18SO, 20SS, 28ML	ADC/Comp	EUSART	40	3	2-16 bit, 1-WDT	—	—	6	—	
PIC18F2331	8,192 EnhFI (4,096)	256	768	22	28SP, 28SO, 28MM	200 ksps ADC	EUSART, I ² C/SPI	40	1	3-16 bit, 1-8 bit, WDT	3	2x10 bit	6	Yes	DM183011 PICDEM™ MC, DM183021 PICDEM™ MC LV, PIC18F4431 Plug-in Module
PIC18F2431	16,384 EnhFI (8,192)	256	768	22	28SP, 28SO, 28MM	200 ksps ADC	EUSART, I ² C/SPI	40	1	3-16 bit, 1-8 bit, WDT	3	2x10 bit	6	Yes	DM183011 PICDEM™ MC, DM183021 PICDEM™ MC LV, PIC18F4431 Plug-in Module
PIC18F4331	8,192 EnhFI (4,096)	256	768	34	40P, 44PT, 44ML	200 ksps ADC	EUSART, I ² C/SPI	40	1	3-16 bit, 1-8 bit, WDT	3	2x10 bit	8	Yes	DM183011 PICDEM™ MC, DM183021 PICDEM™ MC LV, PIC18F4431 Plug-in Module
PIC18F4431	16,384 EnhFI (8,192)	256	768	34	40P, 44PT, 44ML	200 ksps ADC	EUSART, I ² C/SPI	40	1	3-16 bit, 1-8 bit, WDT	3	2x10 bit	8	Yes	DM183011 PICDEM™ MC, DM183021 PICDEM™ MC LV, PIC18F4431 Plug-in Module
dsPIC30F2010	12,288 EnhFI (4,096)	1024	512	20	28SO, 28SP, 28MM (6x6)	1 msps ADC	UART, I ² C/SPI	120	1	3-16 bit, WDT	4	2	6	Yes	DM300020
dsPIC30F3010	24,576 EnhFI (8,102)	1024	1024	20	28SO, 28SP, 44ML (8x8)	1 msps ADC	UART, I ² C/SPI	120	2	5-16 bit, WDT	4	2	6	Yes	DM300020

*Contact Microchip Technology Inc. for availability.

Refer to Motor Control Design Center on www.microchip.com/motor for further details.

Abbreviations are found on the last page of the Selector Guide.

Motor Control Solutions (continued)

Product	Program Memory Bytes & Type (Words)	EEPROM Data Memory Bytes	RAM Bytes	I/O Pins	Packages	Analog Peripherals	Digital Peripherals	Max. Speed MHz	ICD # of Breakpoints	Function-Specific Features					Development Boards
										Timers	Input Capture	Output Comp/Std PWM	Motor Control PWM	Quadrature Encoder	
dsPIC30F3011	24,576 EnhFI (8,102)	1024	1024	30	40P, 44PT, 44ML (8x8)	1 mspcs ADC	2xUART, I ² C/SPI	120	2	5-16 bit, WDT	4	4	6	Yes	DM300020
dsPIC30F4011	49,152 EnhFI (16,384)	1024	2048	30	40P, 44PT, 44ML (8x8)	1 mspcs ADC	2xUART, I ² C/SPI, CAN	120	1	5-16 bit, WDT	4	4	6	Yes	DM300020
dsPIC30F4012	49,152 EnhFI (16,384)	1024	2048	20	28SO, 28SP, 44ML (8x8)	1 mspcs ADC	UART, I ² C/SPI, CAN	120	1	5-16 bit, WDT	4	2	6	Yes	DM300020
dsPIC30F5015	65,536 EnhFI (21,845)	1024	2048	52	64PT	1 mspcs ADC	CAN, I ² C, UART, 2xSPI	120	2	5-16 bit, WDT	4	4	8	Yes	DM300020
dsPIC30F5016	65,536 EnhFI (21,845)	1024	2048	68	80PT	1 mspcs ADC	CAN, I ² C, UART, 2xSPI	120	2	5-16 bit WDT	4	4	8	Yes	DM300020
dsPIC30F6010	147,456 EnhFI (49,152)	4096	8192	68	80PF	1 mspcs ADC	2xCAN, 2xSPI, I ² C, 2xUART	120	2	5-16 bit, WDT	8	8	8	Yes	DM300020
NEW dsPIC30F6010A	144 KB EnhFI (48 KW)	4096	8192	68	80PF, 80PT	1 mspcs ADC	2xCAN, 2xSPI, I ² C, 2xUART	120	2	5-16 bit, WDT	8	8	8	Yes	DM300020
dsPIC30F6015	144 KB EnhFI (48 KW)	4096	8192	52	64PT	1 mspcs ADC	2xCAN, 2xSPI, I ² C, 2xUART	120	2	5-16 bit, WDT	8	8	8	Yes	DM300020
NEW dsPIC33FJ64MC508*	64 KB EnhFI (21 KW)	—	8192	69	80PT	1.1 mspcs ADC	1xECAN, 2xUART, 2xSPI, 2xI ² C	160	4	9x16 or 32-bit, WDT	8	8	8	Yes	
NEW dsPIC33FJ64MC706*	64 KB EnhFI (21 KW)	—	16K	53	64PT	2.2 mspcs ADC	1xECAN, 2xUART, 2xSPI, 2xI ² C	160	4	9x16 or 32-bit, WDT	8	8	8	Yes	
NEW dsPIC33FJ64MC710*	64 KB EnhFI (21 KW)	—	16K	53	100PT, 100PF	2.2 mspcs ADC	1xECAN, 2xUART, 2xSPI, 2xI ² C	160	4	9x16 or 32-bit, WDT	8	8	8	Yes	
NEW dsPIC33FJ128MC706*	128 KB EnhFI (43 KW)	—	16K	53	64PT	2.2 mspcs ADC	2xECAN, 2xUART, 2xSPI, 2xI ² C	160	4	9x16 or 32-bit, WDT	8	8	8	Yes	
NEW dsPIC33FJ128MC708*	128 KB EnhFI (43 KW)	—	16K	69	80PT	2.2 mspcs ADC	2xECAN, 2xUART, 2xSPI, 2xI ² C	160	4	9x16 or 32-bit, WDT	8	8	8	Yes	
NEW dsPIC33FJ256MC710*	256 KB EnhFI (85 KW)	—	30K	85	100PT, 100PF	2.2 mspcs ADC	2xECAN, 2xUART, 2xSPI, 2xI ² C	160	4	9x16 or 32-bit, WDT	8	8	8	Yes	

*Contact Microchip Technology Inc. for availability.
Refer to Motor Control Design Center on www.microchip.com/motor for further details.
Abbreviations are found on the last page of the Selector Guide.

Motor Control Solutions - MOSFET Drivers

Part #	Configuration	Operating Temperature Range (°C)	Peak Output Current (A)	Output Resistance (R _H /R _L) (Max. Ω @ 25°C)	Max. Supply Voltage (V)	Input/Output Delay (td1, td2) ⁽¹⁾ (ns)	Packages
TC1410	Single, Inverting	-40 to +85	0.5	22/22	16	30/30	8-Pin PDIP, 8-Pin SOIC, 8-Pin MSOP
TC1411	Single, Inverting	-40 to +85	1	11/11	16	30/30	8-Pin PDIP, 8-Pin SOIC, 8-Pin MSOP
TC1412	Single, Inverting	-40 to +85	2	6/6	16	35/35	8-Pin PDIP, 8-Pin SOIC, 8-Pin MSOP
TC1413	Single, Inverting	-40 to +85	3	4/4	16	35/35	8-Pin PDIP, 8-Pin SOIC, 8-Pin MSOP
TC4421	Single, Inverting	-40 to +125	9	1.4 (typ)/1.7	18	30/33	8-Pin PDIP, 5-Pin TO-220, 8-Pin DFN
TC4422	Single, Non-inverting	-40 to +125	9	1.4 (typ)/1.7	18	30/33	8-Pin PDIP, 5-Pin TO-220, 8-Pin DFN
TC4423	Dual, Inverting	-40 to +125	3	5/5	18	33/38	8-Pin PDIP, 16-Pin SOIC (W), 8-Pin DFN
TC4425	Dual, Inverting and Non-inverting	-40 to +125	3	5/5	18	33/38	8-Pin PDIP, 16-Pin SOIC (W), 8-Pin DFN

NOTE 1: *td1 = delay time from input low-to-high transition to output transition. td2 = delay time from input high-to-low transition to output transition.

Motor Control Solutions - LINEAR – Comparators

Part #	# per Package	V _{REF} (V)	Typical Propagation Delay (μs)	I _Q Typical (μA)	V _{OS} Max (mV)	Operating Voltage (V)	Temp. Range (°C)	Features	Packages
TC1027	4	1.2	4	18	5	1.8 to 5.5	-40 to +85	On-board V _{REF} , Rail-to-Rail Input/Output	16-Pin PDIP, 16-Pin QSOP, 16-Pin SOIC
TC1037	1	—	4	4	5	1.8 to 5.5	-40 to +85	Rail-to-Rail Input/Output	5-Pin SOT-23A ^(S)
TC1038	1	—	4	4	5	1.8 to 5.5	-40 to +85	Shutdown pin, Rail-to-Rail Input/Output	6-Pin SOT-23A ^(S)
TC1039	1	1.2	4	6	5	1.8 to 5.5	-40 to +85	On-board V _{REF} , Rail-to-Rail Input/Output	6-Pin SOT-23A ^(S)
TC1041	2	1.2	4	10	5	1.8 to 5.5	-40 to +85	On-board V _{REF} , Programmable hysteresis, Rail-to-Rail Input/Output	8-Pin MSOP, 8-Pin SOIC
MCP6541	1	—	4	1	5	1.6 to 5.5	-40 to +85	Push-Pull, Rail-to-Rail Input/Output	5-Pin SOT-23 ^(S,R) , 5-Pin SC-70 ^(S) , 8-Pin PDIP, 8-Pin SOIC, 8-Pin MSOP
MCP6542	2	—	4	1	5	1.6 to 5.5	-40 to +85	Push-Pull, Rail-to-Rail Input/Output	8-Pin PDIP, 8-Pin SOIC, 8-Pin MSOP
MCP6543	1	—	4	1	5	1.6 to 5.5	-40 to +85	Push-Pull, Rail-to-Rail Input/Output, Chip Select	8-Pin PDIP, 8-Pin SOIC, 8-Pin MSOP
MCP6544	4	—	4	1	5	1.6 to 5.5	-40 to +85	Push-Pull, Rail-to-Rail Input/Output	14-Pin PDIP, 14-Pin SOIC, 14-Pin TSSOP
MCP6546	1	—	4	1	5	1.6 to 5.5	-40 to +85	Open-drain, 9V, Rail-to-Rail Input/Output	5-Pin SOT-23 ^(S,R) , 5-Pin SC-70 ^(S) , 8-Pin PDIP, 8-Pin SOIC, 8-Pin MSOP
MCP6547	2	—	4	1	5	1.6 to 5.5	-40 to +85	Open-drain, 9V, Rail-to-Rail Input/Output	8-Pin PDIP, 8-Pin SOIC, 8-Pin MSOP
MCP6548	1	—	4	1	5	1.6 to 5.5	-40 to +85	Open-drain, 9V, Rail-to-Rail Input/Output, Chip Select	8-Pin PDIP, 8-Pin SOIC, 8-Pin MSOP
MCP6549	4	—	4	1	5	1.6 to 5.5	-40 to +85	Open-drain, 9V, Rail-to-Rail Input/Output	14-Pin PDIP, 14-Pin SOIC, 14-Pin TSSOP

Legend: S = Standard Pinout; R = Reverse Pinout

Motor Control Solutions - LINEAR – Op Amps									
Part #	# per Package	GBWP	I _Q Typical (μA)	V _{OS} Max (mV)	Input Voltage Noise Density (nV/rtHz)	Operating Voltage (V)	Temp. Range (°C)	Features	Packages
TC1034	1	90 kHz	6	1.5	125 ⁽¹⁾	1.8 to 5.5	-40 to +85	Rail-to-Rail Input/Output	5-Pin SOT-23A ^(R)
TC1035	1	90 kHz	6	1.5	125 ⁽¹⁾	1.8 to 5.5	-40 to +85	Rail-to-Rail Input/Output, Shutdown pin	6-Pin SOT-23A ^(R)
TC1029	2	90 kHz	12	1.5	125 ⁽¹⁾	1.8 to 5.5	-40 to +85	Rail-to-Rail Input/Output	8-Pin PDIP, 8-Pin MSOP, 8-Pin SOIC
TC1030	4	90 kHz	5	1.5	125 ⁽¹⁾	1.8 to 5.5	-40 to +85	Rail-to-Rail Input/Output, Shutdown pins	16-Pin QSOP
MCP6041	1	14 kHz	0.6	3	170 ⁽¹⁾	1.4 to 5.5	-40 to +85	Rail-to-Rail Input/Output	8-Pin PDIP, 8-Pin SOIC, 8-Pin MSOP, 5-Pin SOT-23 ^(S)
MCP6042	2	14 kHz	0.6	3	170 ⁽¹⁾	1.4 to 5.5	-40 to +85	Rail-to-Rail Input/Output	8-Pin PDIP, 8-Pin SOIC, 8-Pin MSOP
MCP6043	1	14 kHz	0.6	3	170 ⁽¹⁾	1.4 to 5.5	-40 to +85	Rail-to-Rail Input/Output, Chip Select	8-Pin PDIP, 8-Pin SOIC, 8-Pin MSOP
MCP6044	4	14 kHz	0.6	3	170 ⁽¹⁾	1.4 to 5.5	-40 to +85	Rail-to-Rail Input/Output	14-Pin PDIP, 14-Pin SOIC, 14-Pin TSSOP
MCP6141	1	100 kHz	0.6	3	170 ⁽¹⁾	1.4 to 5.5	-40 to +85	Rail-to-Rail Input/Output, G>10 stable	8-Pin PDIP, 8-Pin SOIC, 8-Pin MSOP
MCP6142	2	100 kHz	0.6	3	170 ⁽¹⁾	1.4 to 5.5	-40 to +85	Rail-to-Rail Input/Output, G>10 stable	8-Pin PDIP, 8-Pin SOIC, 8-Pin MSOP
MCP6143	1	100 kHz	0.6	3	170 ⁽¹⁾	1.4 to 5.5	-40 to +85	Rail-to-Rail Input/Output, G>10 stable, Chip Select	8-Pin PDIP, 8-Pin SOIC, 8-Pin MSOP
MCP6144	4	100 kHz	0.6	3	170 ⁽¹⁾	1.4 to 5.5	-40 to +85	Rail-to-Rail Input/Output, G>10 stable	14-Pin PDIP, 14-Pin SOIC, 14-Pin TSSOP
MCP606	1	155 kHz	19	0.25	38 ⁽¹⁾	2.5 to 5.5	-40 to +85	Rail-to-Rail Output	8-Pin PDIP, 8-Pin SOIC, 8-Pin TSSOP, 5-Pin SOT23 ^(S)
MCP607	2	155 kHz	19	0.25	38 ⁽¹⁾	2.5 to 5.5	-40 to +85	Rail-to-Rail Output	8-Pin PDIP, 8-Pin SOIC, 8-Pin TSSOP
MCP608	1	155 kHz	19	0.25	38 ⁽¹⁾	2.5 to 5.5	-40 to +85	Rail-to-Rail Output, Chip Select	8-Pin PDIP, 8-Pin SOIC, 8-Pin TSSOP
MCP609	4	155 kHz	19	0.25	38 ⁽¹⁾	2.5 to 5.5	-40 to +85	Rail-to-Rail Output	14-Pin PDIP, 14-Pin SOIC, 14-Pin TSSOP
MCP616	1	190 kHz	19	0.15	32 ⁽¹⁾	2.3 to 5.5	-40 to +85	Rail-to-Rail Output, PNP Input	8-Pin PDIP, 8-Pin SOIC, 8-Pin MSOP
MCP617	2	190 kHz	19	0.15	32 ⁽¹⁾	2.3 to 5.5	-40 to +85	Rail-to-Rail Output, PNP	8-Pin PDIP, 8-Pin SOIC, 8-Pin MSOP
MCP618	1	190 kHz	19	0.15	32 ⁽¹⁾	2.3 to 5.5	-40 to +85	Rail-to-Rail Output, Chip Select, PNP Input	8-Pin PDIP, 8-Pin SOIC, 8-Pin MSOP
MCP619	4	190 kHz	19	0.15	32 ⁽¹⁾	2.3 to 5.5	-40 to +85	Rail-to-Rail Output, PNP Input	14-Pin PDIP, 14-Pin SOIC, 14-Pin TSSOP
MCP6231	1	300 kHz	20	5	52 ⁽¹⁾	1.8 to 5.5	-40 to +125	Rail-to-Rail Input/Output	5-Pin SC-70 ^(U) , 5-Pin SOT-23 ^(S,R,U) , 8-Pin PDIP, 8-Pin SOIC, 8-Pin MSOP
MCP6232	2	300 kHz	20	5	52 ⁽¹⁾	1.8 to 5.5	-40 to +125	Rail-to-Rail Input/Output	8-Pin PDIP, 8-Pin SOIC, 8-Pin MSOP
MCP6234	4	300 kHz	20	5	52 ⁽¹⁾	1.8 to 5.5	-40 to +125	Rail-to-Rail Input/Output	14-Pin PDIP, 14-Pin SOIC, 14-Pin TSSOP
MCP6241	1	550 kHz	50	5	45 ⁽¹⁾	1.8 to 5.5	-40 to +125	Rail-to-Rail Input/Output	5-Pin SC-70 ^(U) , 5-Pin SOT-23 ^(S,R,U) , 8-Pin PDIP, 8-Pin SOIC, 8-Pin MSOP
MCP6242	2	550 kHz	50	5	45 ⁽¹⁾	1.8 to 5.5	-40 to +125	Rail-to-Rail Input/Output	8-Pin PDIP, 8-Pin SOIC, 8-Pin MSOP

Legend: S = Standard Pinout; R = Reverse Pinout; U = Alternative Pinout

NOTE 1: Values are typical at 1 kHz

NOTE 2: Values are typical at 10 kHz

Motor Control Solutions - LINEAR – Op Amps (continued)

Part #	# per Package	GBWP	I _Q Typical (μA)	V _{OS} Max (mV)	Input Voltage Noise Density (nV/rtHz)	Operating Voltage (V)	Temp. Range (°C)	Features	Packages
MCP6244	4	550 kHz	50	5	45 ⁽¹⁾	1.8 to 5.5	-40 to +125	Rail-to-Rail Input/Output	14-Pin PDIP, 14-Pin SOIC, 14-Pin TSSOP
MCP6001	1	1 MHz	140	4.5	28 ⁽¹⁾	1.8 to 5.5	-40 to +125	Rail-to-Rail Input/Output	5-Pin SOT-23 ^(U) , 5-Pin SC-70 ^(S,R,U)
MCP6002	2	1 MHz	140	4.5	28 ⁽¹⁾	1.8 to 5.5	-40 to +125	Rail-to-Rail Input/Output	8-Pin PDIP, 8-Pin SOIC, 8-Pin MSOP
MCP6004	4	1 MHz	140	4.5	28 ⁽¹⁾	1.8 to 5.5	-40 to +125	Rail-to-Rail Input/Output	14-Pin PDIP, 14-Pin SOIC, 14-Pin TSSOP
MCP6271	1	2 MHz	170	3	20 ⁽¹⁾	2.0 to 5.5	-40 to +125	Rail-to-Rail Input/Output	5-Pin SOT-23 ^(S,R) , 8-Pin PDIP, 8-Pin SOIC, 8-Pin MSOP
MCP6272	2	2 MHz	170	3	20 ⁽¹⁾	2.0 to 5.5	-40 to +125	Rail-to-Rail Input/Output	8-Pin PDIP, 8-Pin SOIC, 8-Pin MSOP
MCP6273	1	2 MHz	170	3	20 ⁽¹⁾	2.0 to 5.5	-40 to +125	Rail-to-Rail Input/Output, Chip Select	5-Pin SOT-23 ^(S) , 8-Pin PDIP, 8-Pin SOIC, 8-Pin MSOP
MCP6274	4	2 MHz	170	3	20 ⁽¹⁾	2.0 to 5.5	-40 to +125	Rail-to-Rail Input/Output	14-Pin PDIP, 14-Pin SOIC, 14-Pin TSSOP
MCP6275	2	2 MHz	150	3	20 ⁽¹⁾	2.0 to 5.5	-40 to +125	Rail-to-Rail Input/Output, Dual connected, Chip Select	8-Pin PDIP, 8-Pin SOIC, 8-Pin MSOP
MCP601	1	2.8 MHz	230	2	29 ⁽¹⁾	2.7 to 5.5	-40 to +125	Rail-to-Rail Output	5-Pin SOT-23 ^(S,R) , 8-Pin PDIP, 8-Pin SOIC, 8-Pin TSSOP
MCP602	2	2.8 MHz	230	2	29 ⁽¹⁾	2.7 to 5.5	-40 to +125	Rail-to-Rail Output	8-Pin PDIP, 8-Pin SOIC, 8-Pin TSSOP
MCP603	1	2.8 MHz	230	2	29 ⁽¹⁾	2.7 to 5.5	-40 to +125	Rail-to-Rail Output, Chip Select	6-Pin SOT-23 ^(S) , 8-Pin PDIP, 8-Pin SOIC, 8-Pin TSSOP
MCP604	4	2.8 MHz	230	2	29 ⁽¹⁾	2.7 to 5.5	-40 to +125	Rail-to-Rail Output	14-Pin PDIP, 14-Pin SOIC, 14-Pin TSSOP
MCP6281	1	5 MHz	445	3	16 ⁽¹⁾	2.2 to 5.5	-40 to +125	Rail-to-Rail Input/Output	5-Pin SOT-23 ^(S,R) , 8-Pin PDIP, 8-Pin SOIC, 8-Pin MSOP
MCP6282	2	5 MHz	445	3	16 ⁽¹⁾	2.2 to 5.5	-40 to +125	Rail-to-Rail Input/Output	8-Pin PDIP, 8-Pin SOIC, 8-Pin MSOP
MCP6283	1	5 MHz	445	3	16 ⁽¹⁾	2.2 to 5.5	-40 to +125	Rail-to-Rail Input/Output, Chip Select	6-Pin SOT-23 ^(S,R) , 8-Pin PDIP, 8-Pin SOIC, 8-Pin MSOP
MCP6284	4	5 MHz	445	3	16 ⁽¹⁾	2.2 to 5.5	-40 to +125	Rail-to-Rail Input/Output	14-Pin PDIP, 14-Pin SOIC, 14-Pin TSSOP
MCP6285	2	5 MHz	400	3	16 ⁽¹⁾	2.2 to 5.5	-40 to +125	Rail-to-Rail Input/Output, Dual connected, Chip Select	8-Pin PDIP, 8-Pin SOIC, 8-Pin MSOP
MCP6291	1	10 MHz	1000	3	8.7 ⁽²⁾	2.4 to 5.5	-40 to +125	Rail-to-Rail Input/Output	5-Pin SOT-23 ^(S,R) , 8-Pin PDIP, 8-Pin SOIC, 8-Pin MSOP
MCP6292	2	10 MHz	1000	3	8.7 ⁽²⁾	2.4 to 5.5	-40 to +125	Rail-to-Rail Input/Output	8-Pin PDIP, 8-Pin SOIC, 8-Pin MSOP
MCP6293	1	10 MHz	1000	3	8.7 ⁽²⁾	2.4 to 5.5	-40 to +125	Rail-to-Rail Input/Output, Chip Select	6-Pin SOT-23 ^(S) , 8-Pin PDIP, 8-Pin SOIC, 8-Pin MSOP
MCP6294	4	10 MHz	1000	3	8.7 ⁽²⁾	2.4 to 5.5	-40 to +125	Rail-to-Rail Input/Output	14-Pin PDIP, 14-Pin SOIC, 14-Pin TSSOP
MCP6295	2	10 MHz	1100	3	8.7 ⁽²⁾	2.4 to 5.5	-40 to +125	Rail-to-Rail Input/Output, Dual connected, Chip Select	8-Pin PDIP, 8-Pin SOIC, 8-Pin MSOP

Legend: S = Standard Pinout; R = Reverse Pinout; U = Alternative Pinout

NOTE 1: Values are typical at 1 kHz
2: Values are typical at 10 kHz

Motor Control Solutions - LINEAR – Op Amps (continued)

Part #	# per Package	GBWP	I _Q Typical (μA)	V _{OS} Max (mV)	Input Voltage Noise Density (nV/rtHz)	Operating Voltage (V)	Temp. Range (°C)	Features	Packages
MCP6021	1	10 MHz	1000	0.5	8.7 ⁽²⁾	2.5 to 5.5	-40 to +125	Rail-to-Rail Input/Output, 1/2 V _{CC} V _{REF}	8-Pin PDIP, 8-Pin SOIC, 8-Pin TSSOP
MCP6022	2	10 MHz	1000	0.5	8.7 ⁽²⁾	2.5 to 5.5	-40 to +125	Rail-to-Rail Input/Output	8-Pin PDIP, 8-Pin SOIC, 8-Pin TSSOP
MCP6023	1	10 MHz	1000	0.5	8.7 ⁽²⁾	2.5 to 5.5	-40 to +125	Rail-to-Rail Input/Output, Chip Select	8-Pin PDIP, 8-Pin SOIC, 8-Pin TSSOP
MCP6024	4	10 MHz	1000	0.5	8.7 ⁽²⁾	2.5 to 5.5	-40 to +125	Rail-to-Rail Input/Output	14-Pin PDIP, 14-Pin SOIC, 14-Pin TSSOP

Legend: S = Standard Pinout; R = Reverse Pinout; U = Alternative Pinout
 NOTE 1: Values are typical at 1 kHz
 2: Values are typical at 10 kHz

Motor Control Solutions - LINEAR – High Precision Operational Amplifiers

Part #	# per Package	GBWP	I _Q MAX (mA)	Typical V _{OS} (μV)	V _{OS} Drift Max (μV/°C)	Operating Voltage (V)	Temp. Range (°C)	Features	Packages
TC913A/B	2	1.5 MHz	1.1	15	0.15/0.30	6.5 to 16	0 to 70	Single and Split Supply	8-Pin PDIP, 8-Pin SOIC

High-Speed Sensing Solutions

Product	Program Memory Bytes & Type (Words)	EEPROM Data Memory Bytes	SRAM Bytes	I/O Pins (max.)	Packages	A/D 12-bit 100 ksps (ch)	A/D 10-bit 500 ksps	Timer 16-bit	Input Cap	Output Comp/Std PWM	Motor Control PWM	Quad. Encoder	UART	SPI™	I ² C™
dsPIC30F2011	12,288 EnhFI (4,096)	—	1024	12	18SO, 18P, 28ML (6x6)	8	—	3	2	2	—	—	1	1	1
dsPIC30F3012	24,576 EnhFI (8,192)	1024	2048	12	18SO, 18P, 44ML (8x8)	8	—	3	2	2	—	—	1	1	1
dsPIC30F2012	12,288 EnhFI (4,096)	—	1024	20	28SO, 28SP, 28ML (6x6)	10	—	3	2	2	—	—	1	1	1
dsPIC30F3013	24,576 EnhFI (8,192)	1024	2048	20	28SO, 28SP, 28ML (6x6)	10	—	3	2	2	—	—	2	1	1

Abbreviations are found on the last page of the Selector Guide.

Power-Managed Solutions Featuring nanoWatt Technology			
Minimum nanoWatt Feature Set (VDD = 2.0-5.5V)	6-20 Pin	28-44 Pin	64-100 Pin
Internal Oscillator	PIC16F627A, PIC16F628A, PIC16F648A		
Quick Start-up (4 MHz)			
Power-Managed Modes			
Sleep			
Low-Power Timer1			
Low-Power Watchdog			
Additional Features to Minimum	6-20 Pin	28-44 Pin	64-80 Pin
IntOSC: Quick Start-up (Two-Speed) and Clock Divide (8 MHz) BOR	PIC16F818, PIC16F819		
IntOSC: Quick Start-up (Two-Speed), Fail-Safe Clock Monitor and Clock Divide (8 MHz) Ultra Low-Power Wake-up	PIC12F683 PIC16F684, PIC16F688		
IntOSC: Quick Start-up (Two-Speed), Fail-Safe Clock Monitor and Clock Divide (8 MHz) Ultra Low-Power Wake-up Low-Power Watchdog – Enhanced Software Controlled BOR	PIC16F631, PIC16F677, PIC16F685, PIC16F687, PIC16F689, PIC16F785, PIC16F690, PIC16F88X, PIC16F946		
IntOSC: Quick Start-up (Two-Speed), Fail-Safe Clock Monitor and Clock Divide (8 MHz) Ultra Low-Power Wake-up Wake-up Reset Low-Power Watchdog – Enhanced PLVD Software Controlled BOR	PIC12F635 PIC16F636, PIC16F639		
IntOSC: Quick Start-up (Two-Speed), Fail-Safe Clock Monitor and Selectable Clock (31 kHz-8 MHz) Power-Managed Modes: RC Run Modes PLVD PBOR	PIC16F87, PIC16F88	PIC16F7X7, PIC16F91X	PIC16F946
IntOSC: Quick Start-up (Two-Speed), Fail-safe Clock Monitor and Selectable Clock (31 kHz) Power-Managed Modes: Multiple Idle Modes and RC Run Modes BOR		PIC18F2XJXX, PIC18F4XJXX	PIC18F6XJXX, PIC18F8XJXX
IntOSC: Quick Start-up (Two-Speed), Fail-Safe Clock Monitor and Selectable Clock (31 kHz-8 MHz) Power-Managed Modes: Multiple Idle Modes and RC Run Modes PBOR			PIC24FJ
IntOSC: Quick Start-up (Two-Speed), Fail-Safe Clock Monitor and Selectable Clock (31 kHz-8 MHz) Power-Managed Modes: Multiple Idle Modes and RC Run Modes PLVD PBOR	PIC18F1X20, PIC18F1X30	PIC18F2XXX, PIC18F4XXX, PIC18FXK20	PIC18F6XXX, PIC18F8XXX

For additional details, please refer to device data sheets and design pages on www.microchip.com.

CURRENT SECURE DATA PRODUCTS

KEELOQ® Encoder Devices											
Product	Transmission Code Length Bits	Code Hopping Bits	Programmable Encryption Key Bits	Seed Length	Operating Voltage (V)	Turnable OSC	Function Codes	CRC	Protocols	Other Features	Packages
HCS101	66	—	—	—	3.5 to 13.0	✓	7	No	PWM	Fixed code support for non-secure applications, up to 28-bit serial numbers	8P, 8SN
HCS200	66	32	64	32	3.5 to 13.0	No	7	No	PWM	Entry level, Fixed code support, Battery-low indicator	8P, 8SN
HCS201	66	32	64	32	3.5 to 13.0	✓	7	No	PWM	Entry level, Fixed code support, Battery-low indicator, Step-up voltage operation	8P, 8SN
HCS300	66	32	64	32	2.0 to 6.3	No	15	No	PWM	LED Drive, Overflow bits, Time-out, Battery-low indicator	8P, 8SN
HCS301	66	32	64	32	3.5 to 13.0	No	15	No	PWM	LED Drive, Overflow bits, Time-out, Battery-low indicator	8P, 8SN
HCS320	66	32	64	32	3.5 to 13.0	No	16	No	PWM	Shift Operation, LED Drive, Overflow bits, Time-out, Battery-low indicator	8P, 8SN
HCS360	67	32	64	48	2.0 to 6.3	No	15	✓	IR Mode, PWM and Manchester	2 independent counters	8P, 8SN
HCS361	67	32	64	48	2.0 to 6.3	No	15	✓	IR Mode, PWM and VPWM	2 independent counters	8P, 8SN
HCS362	69	32	2 x 64	60	2.0 to 6.3	✓	15	✓	PWM and Manchester	Queue counter, PLL interface, Timer bits, Programmable time-out	8P, 8SN, 8ST
HCS365	69	32	2 x 64	2 x 60	2.05 to 5.5	Factory	15	✓	PWM, VPWM PPM and Manchester	Dual Encoder Operation, 4 inputs, Queue counter	8P, 8SM
HCS370	69	32	2 x 64	2 x 60	2.05 to 5.5	Factory	15	✓	PWM, VPWM PPM and Manchester	Step-up voltage regulation, Dual Encoder Operation, 6 inputs, Queue counter	14P, 14SL
HCS410	69	32	2 x 64	60	2.0 to 6.6	✓	7	✓	PWM and Manchester	Self-powered transponder and encoder, Bidirectional authentication, User EEPROM, Queue counter	8P, 8SN, 8ST

KEELOQ® Decoder Devices							
Product	Reception Length Bits	Encoders Supported**	Transmitters Supported	Operating Voltage (V)	Functions	Other Features	Packages
HCS500	66	HCS200, HCS201, HCS300, HCS301, HCS320, HCS360, HCS361, HCS362, HCS365, HCS370, HCS410, HCS412, HCS473	Up to 7	3.0 to 5.5	S0, 15 Serial Functions	Full-featured decoder with serial interface to microcontrollers	8P, 8SM
HCS512	66	HCS200, HCS201, HCS300, HCS301, HCS320, HCS360, HCS361, HCS362, HCS365, HCS370, HCS410, HCS412, HCS473	Up to 4	4.0 to 6.0	S0, S1, S2, S3; VLow, 15 Serial Functions	Single chip decoder with secure learning	18P, 18SO
HCS515	66	HCS200, HCS201, HCS300, HCS301, HCS320, HCS360, HCS361, HCS362, HCS365, HCS370, HCS410, HCS412, HCS473	Up to 7	4.5 to 5.5	S0, S1, 15 Serial Functions	Full-featured decoder with serial and parallel interface. On-chip 1K transmitter and 1K user EEPROM.	14P, 14SL

KEELOQ® Programmable Encoder/Decoder Flash Devices (x14), ICSP™															
Product	Program Memory Bytes & Type (Words)	EEPROM Data Memory (Bytes)	RAM Bytes	I/O Pins	Analog		Digital		Max. Speed MHz	IntOSC	BOR/PLVD	ICD # of Breakpoints	nW	Other Features	Packages
					ADC Channels	Comparators	Timers/WDT	Serial I/O							
PIC12F635	1,792 StdFI (1,024)	128	64	6	—	1	1-16 bit, 1-8 bit, 1-WDT	—	20	8 MHz	BOR/PLVD	1**	✓		8P, 8SN, 8MF
PIC16F636	3,584 StdFI (2,048)	256	128	12	—	2	1-16 bit, 1-8 bit, 1-WDT	—	20	8 MHz	BOR/PLVD	1**	✓		14P, 14SL, 14ST
PIC16F639	3,584 StdFI (2,048)	256	128	12	—	2	1-16 bit, 1-8 bit, 1-WDT	—	20	8 MHz	BOR/PLVD	1**	✓	Transponder Analog Front End	20P, 20SO, 20SS

** Requires ICD specific device with header module – refer to Development Tools. Abbreviations are found on the last page of the Selector Guide.

CURRENT SERIAL ELECTRICALLY ERASABLE PROMS (EEPROM)

Product	E/W Cycles	Density (Organization)	Write Speed	Max. Clock Freq.	Operating Voltage (V)	Temps	Max. Standby Current	Unique Features	Packages ⁽¹⁾
Microwire Compatible Serial EEPROM Family – Automatic ERAL before WRAL, self-timed erase and write cycle, power on/off data protection circuitry, sequential read function and industry standard 3-wire serial I/O									
93C46A	1M	1 Kbit (x8)	2 ms	2 MHz	4.5 to 5.5	C, I, E	5 µA	93Cx6A and 93Cx6B devices have no ORG pin. 93Cx6A parts have x8 organization; 93Cx6B parts are x16. Devices in this family include POR (VDD detect) feature. Use 93C76C or 93C86C devices for P, SN, ST or MS packages. Use 93C76C or 93C86C devices for P, SN, ST or MS packages. Use 93C76C or 93C86C devices for P, SN, ST or MS packages. Use 93C76C or 93C86C devices for P, SN, ST or MS packages.	P, SN, ST, MS, OT, X/SN, MC
93C46B	1M	1 Kbit (x16)	2 ms	2 MHz	4.5 to 5.5	C, I, E	5 µA		P, SN, ST, MS, OT, X/SN, MC
93C56A	1M	2 Kbits (x8)	2 ms	2 MHz	4.5 to 5.5	I, E	5 µA		P, SN, ST, MS, OT, MC
93C56B	1M	2 Kbits (x16)	2 ms	2 MHz	4.5 to 5.5	I, E	5 µA		P, SN, ST, MS, OT, MC
93C66A	1M	4 Kbits (x8)	2 ms	2 MHz	4.5 to 5.5	I, E	5 µA		P, SN, ST, MS, OT, MC
93C66B	1M	4 Kbits (x16)	2 ms	2 MHz	4.5 to 5.5	I, E	5 µA		P, SN, ST, MS, OT, MC
93C76A	1M	8 Kbits (x8)	2 ms	3 MHz	4.5 to 5.5	I, E	5 µA		OT
93C76B	1M	8 Kbits (x16)	2 ms	3 MHz	4.5 to 5.5	I, E	5 µA		OT
93C86A	1M	16 Kbits (x8)	2 ms	3 MHz	4.5 to 5.5	I, E	5 µA		OT
93C86B	1M	16 Kbits (x16)	2 ms	3 MHz	4.5 to 5.5	I, E	5 µA		OT
93LC46A	1M	1 Kbit (x8)	6 ms	2 MHz	2.5 to 5.5	C, I, E	5 µA	93LCx6A and 93LCx6B devices have no ORG pin. 93LCx6A parts have x8 organization; 93LCx6B parts are x16. Use 93LC76C or 93LC86C devices for P, SN, ST or MS packages. Use 93LC76C or 93LC86C devices for P, SN, ST or MS packages. Use 93LC76C or 93LC86C devices for P, SN, ST or MS packages. Use 93LC76C or 93LC86C devices for P, SN, ST or MS packages.	P, SN, ST, MS, OT, X/SN, MC
93LC46B	1M	1 Kbit (x16)	6 ms	2 MHz	2.5 to 5.5	C, I, E	5 µA		P, SN, ST, MS, OT, X/SN, MC
93LC56A	1M	2 Kbits (x8)	6 ms	2 MHz	2.5 to 5.5	C, I, E	5 µA		P, SN, ST, MS, OT, X/SN, MC
93LC56B	1M	2 Kbits (x16)	6 ms	2 MHz	2.5 to 5.5	C, I, E	5 µA		P, SN, ST, MS, OT, X/SN, MC
93LC66A	1M	4 Kbits (x8)	6 ms	2 MHz	2.5 to 5.5	C, I, E	5 µA		P, SN, ST, MS, OT, X/SN, MC
93LC66B	1M	4 Kbits (x16)	6 ms	2 MHz	2.5 to 5.5	C, I, E	5 µA		P, SN, ST, MS, OT, X/SN, MC
93LC76A	1M	8 Kbits (x8)	6 ms	3 MHz	2.5 to 5.5	I, E	5 µA		OT
93LC76B	1M	8 Kbits (x16)	6 ms	3 MHz	2.5 to 5.5	I, E	5 µA		OT
93LC86A	1M	16 Kbits (x8)	6 ms	3 MHz	2.5 to 5.5	I, E	5 µA		OT
93LC86B	1M	16 Kbits (x16)	6 ms	3 MHz	2.5 to 5.5	I, E	5 µA		OT
93AA46A	1M	1 Kbit (x8)	6 ms	2 MHz	1.8 to 5.5	I	5 µA	93AAx6A and 93AAx6B devices have no ORG pin. 93AAx6A parts have x8 organization; 93Cx6B parts are x16. Use 93AA76C or 93AA86C devices for P, SN, ST or MS packages. Use 93AA76C or 93AA86C devices for P, SN, ST or MS packages. Use 93AA76C or 93AA86C devices for P, SN, ST or MS packages. Use 93AA76C or 93AA86C devices for P, SN, ST or MS packages.	P, SN, ST, MS, OT, MC
93AA46B	1M	1 Kbit (x16)	6 ms	2 MHz	1.8 to 5.5	I	5 µA		P, SN, ST, MS, OT, MC
93AA56A	1M	2 Kbits (x8)	6 ms	2 MHz	1.8 to 5.5	I	5 µA		P, SN, ST, MS, OT, MC
93AA56B	1M	2 Kbits (x16)	6 ms	2 MHz	1.8 to 5.5	I	5 µA		P, SN, ST, MS, OT, MC
93AA66A	1M	4 Kbits (x8)	6 ms	2 MHz	1.8 to 5.5	I	5 µA		P, SN, ST, MS, OT, MC
93AA66B	1M	4 Kbits (x16)	6 ms	2 MHz	1.8 to 5.5	I	5 µA		P, SN, ST, MS, OT, MC
93AA76A	1M	8 Kbits (x8)	6 ms	3 MHz	1.8 to 5.5	I	5 µA		OT
93AA76B	1M	8 Kbits (x16)	6 ms	3 MHz	1.8 to 5.5	I	5 µA		OT
93AA86A	1M	16 Kbits (x8)	6 ms	3 MHz	1.8 to 5.5	I	5 µA		OT
93AA86B	1M	16 Kbits (x16)	6 ms	3 MHz	1.8 to 5.5	I	5 µA		OT
93C46C	1M	1 Kbit (x8 or x16)	2 ms	3 MHz	4.5 to 5.5	I, E	5 µA	93Cx6C devices can be used in either x8 or x16 organization via the ORG pin. Devices in this family include POR (VDD detect) feature.	P, SN, ST, MS, MC
93C56C	1M	2 Kbits (x8 or x16)	2 ms	3 MHz	4.5 to 5.5	I, E	5 µA		P, SN, ST, MS, MC
93C66C	1M	4 Kbits (x8 or x16)	2 ms	3 MHz	4.5 to 5.5	I, E	5 µA		P, SN, ST, MS, MC
93C76C	1M	8 Kbits (x8 or x16)	2 ms	3 MHz	4.5 to 5.5	I, E	5 µA		P, SN, ST, MS, MC
93C86C	1M	16 Kbits (x8 or x16)	2 ms	3 MHz	4.5 to 5.5	I, E	5 µA		P, SN, ST, MS, MC
93LC46C	1M	1 Kbit (x8 or x16)	6 ms	3 MHz	2.5 to 5.5	I, E	5 µA	93LCx6C devices can be used in either x8 or x16 organization via the ORG pin.	P, SN, ST, MS, X/SN, MC
93LC56C	1M	2 Kbits (x8 or x16)	6 ms	3 MHz	2.5 to 5.5	I, E	5 µA		P, SN, ST, MS, X/SN, MC
93LC66C	1M	4 Kbits (x8 or x16)	6 ms	3 MHz	2.5 to 5.5	I, E	5 µA		P, SN, ST, MS, X/SN, MC
93LC76C	1M	8 Kbits (x8 or x16)	6 ms	3 MHz	2.5 to 5.5	I, E	5 µA		P, SN, ST, MS, MC
93LC86C	1M	16 Kbits (x8 or x16)	6 ms	3 MHz	2.5 to 5.5	I, E	5 µA		P, SN, ST, MS, MC
93AA46C	1M	1 Kbit (x8 or x16)	6 ms	3 MHz	1.8 to 5.5	I	5 µA	93AAx6C devices can be used in either x8 or x16 organization via the ORG pin.	P, SN, ST, MS, X/SN, MC
93AA56C	1M	2 Kbits (x8 or x16)	6 ms	3 MHz	1.8 to 5.5	I	5 µA		P, SN, ST, MS, X/SN, MC
93AA66C	1M	4 Kbits (x8 or x16)	6 ms	3 MHz	1.8 to 5.5	I	5 µA		P, SN, ST, MS, X/SN, MC
93AA76C	1M	8 Kbits (x8 or x16)	6 ms	3 MHz	1.8 to 5.5	I	5 µA		P, SN, ST, MS, MC
93AA86C	1M	16 Kbits (x8 or x16)	6 ms	3 MHz	1.8 to 5.5	I	5 µA		P, SN, ST, MS, MC

NOTE 1. X/SN package code denotes rotated pinouts.

Product	E/W Cycles	Density (Organization)	Write Speed	Max. Clock Frequency	Operating Voltage (V)	Temps	Unique Features	Packages
2-Wire I²C™ Compatible Serial EEPROM Family – Self-timed write cycle and Page Write mode								
24C00 24LC00 24AA00	1M 1M 1M	128 bits (x8) 128 bits (x8) 128 bits (x8)	4 ms 4 ms 4 ms	400 kHz 400 kHz 400 kHz	4.5 to 5.5 2.5 to 6.0 1.8 to 6.0	C, I, E C, I C, I	100 kHz operation for voltages from 1.8V to 4.5V.	P, SN, ST, OT, MC P, SN, ST, OT, MC P, SN, ST, OT, MC
24C01C 24C02C	1M 1M	1 Kbit (x8) 2 Kbits (x8)	1 ms 1 ms	400 kHz 400 kHz	4.5 to 5.5 4.5 to 5.5	C, I, E C, I, E	The 24C01C and 24C02C are for applications which require fast byte write and/or extended temperature. Three address pins.	P, SN, ST, MS, MC P, SN, ST, MS, MC
24LC014 24AA014	1M 1M	1 Kbit (x8) 1 Kbit (x8)	10 ms 10 ms	400 MHz 400 MHz	2.5 to 5.5 1.8 to 5.5	I I	Three address pins.	P, SN, ST, MS, MC P, SN, ST, MS, MC
24LC01B 24LC02B 24LC04B 24LC08B 24LC16B	1M 1M 1M 1M 1M	1 Kbit (x8) 2 Kbits (x8) 4 Kbits (x8) 8 Kbits (x8) 16 Kbits (x8)	5 ms 5 ms 5 ms 5 ms 5 ms	400 kHz 400 kHz 400 kHz 400 kHz 400 kHz	2.5 to 5.5 2.5 to 5.5 2.5 to 5.5 2.5 to 5.5 2.5 to 5.5	I, E I, E I, E I, E I, E	Hardware write protect. Schmitt trigger inputs. 2.5V operation @ extended temperatures. 100 kHz operation @ extended temperatures. B version on 2-wire devices designates that address pins A0, A1, A2 are no-connect.	P, SN, ST, MS, OT, MC P, SN, ST, MS, OT, MC P, SN, ST, MS, OT, MC P, SN, ST, MS, OT, MC P, SN, ST, MS, OT, MC
24AA01 24AA02 24AA04 24AA08 24AA16	1M 1M 1M 1M 1M	1 Kbit (x8) 2 Kbits (x8) 4 Kbits (x8) 8 Kbits (x8) 16 Kbits (x8)	5 ms 5 ms 5 ms 5 ms 5 ms	400 kHz 400 kHz 400 kHz 400 kHz 400 kHz	1.8 to 5.5 1.8 to 5.5 1.8 to 5.5 1.8 to 5.5 1.8 to 5.5	I I I I I	Hardware write protect. Schmitt trigger inputs. 100 kHz operation for voltages from 1.8V to 2.5V. For all devices in this section (24AA01 through 24AA16), pins A0, A1, A2 are no-connect.	P, SN, ST, MS, OT, MC P, SN, ST, MS, OT, MC P, SN, ST, MS, OT, MC P, SN, ST, MS, OT, MC P, SN, ST, MS, OT, MC
24LC32A 24AA32A	1M 1M	32 Kbits (x8) 32 Kbits (x8)	5 ms 5 ms	400 kHz 400 kHz	2.5 to 5.5 1.8 to 5.5	I, E I	100 kHz operation for voltages from 1.8V to 2.5V.	P, SN, SM, ST, MS, MC P, SN, SM, ST, MS, MC
24LC64 24AA64	1M 1M	64 Kbits (x8) 64 Kbits (x8)	5 ms 5 ms	400 kHz 400 kHz	2.5 to 5.5 1.8 to 5.5	I, E I	32-byte page. 100 kHz operation for voltages from 1.8V to 2.5V.	P, SN, SM, ST, MS, MC P, SN, SM, ST, MS, MC
24LC65 24AA65 24C65	1 M/10 M 1 M/10 M 1 M/10 M	64 Kbits (x8) 64 Kbits (x8) 64 Kbits (x8)	5 ms 5 ms 5 ms	400 kHz 400 kHz 400 kHz	2.5 to 5.5 1.8 to 5.5 4.5 to 5.5	C, I C C, I, E	8-byte page, 64-byte input buffer, high-endurance block, write protectable in 4K blocks. Smart Serial™ EEPROM.	P, SM P, SM P, SM
24LC128 24AA128 24FC128	1M 1M 1M	128 Kbits (x8) 128 Kbits (x8) 128 Kbits (x8)	5 ms 5 ms 5 ms	400 kHz 400 kHz 1 MHz	2.5 to 5.5 1.8 to 5.5 2.5 to 5.5	I, E I I	64-byte page. 100 kHz operation for voltages from 1.8V to 2.5V. 400 kHz operation for voltages below 4.5V (24FC128).	P, SN, SM, ST, MS, MF P, SN, SM, ST, MS, MF P, SN, SM, ST, MS, MF
24LC256 24AA256 24FC256	1M 1M 1M	256 Kbits (x8) 256 Kbits (x8) 256 Kbits (x8)	5 ms 5 ms 5 ms	400 kHz 400 kHz 1 MHz	2.5 to 5.5 1.8 to 5.5 2.5 to 5.5	I, E I I	64-byte page. 100 kHz operation for voltages from 1.8V to 2.5V. 400 kHz operation for voltages below 4.5V (24FC256).	P, SM, SN, ST, MS, MF P, SM, SN, ST, MS, MF P, SN, SM, ST, MS, MF
24LC512 24AA512 24FC512	1M 1M 1M	512 Kbits (x8) 512 Kbits (x8) 512 Kbits (x8)	5 ms 5 ms 5 ms	400 kHz 400 kHz 1 MHz	2.5 to 5.5 1.8 to 5.5 2.5 to 5.5	I, E I I	128-byte page, cascadeable up to 8 devices (4 Mbits). 100 kHz operation for voltages from 1.8 to 2.5V. 400 kHz operation for voltages below 4.5V. (24FC512).	P, MF, ST14, SM P, MF, ST14, SM P, MF, ST14, SM
24LC515 24AA515 24FC515	1M 1M 1M	512 Kbits (x8) 512 Kbits (x8) 512 Kbits (x8)	5 ms 5 ms 5 ms	400 kHz 400 kHz 1 MHz	2.5 to 5.5 1.8 to 5.5 2.5 to 5.5	I I I	Cascadeable up to 4 devices (2 Mbits). 100 kHz operation for voltages from 1.8V to 2.5V.	P, SM P, SM P, SM
24LC1025 24AA1025	1M 1M	1 Mbit (x8) 1 Mbit (x8)	5 ms 5 ms	400 kHz 400 kHz	2.5 to 5.5 1.8 to 5.5	I, E I	Cascade up to 4 devices Cascade up to 4 devices, 100 kHz @ 1.8V-2.5V	P, SM P, SM

Product	E/W Cycles	Density (Organization)	Write Speed	Max. Clock Frequency	Operating Voltage (V)	Temps	Unique Features	Packages
ISO Smart Card Family – Self-timed write cycle and Page Write mode. All devices meet ISO7816 pinout requirements.								
24LC01SC	1M	1 Kbit (x8)	5 ms	400 kHz	2.5 to 5.5	C, I		S, W, WF
24LC02SC	1M	2 Kbits (x8)	5 ms	400 kHz	2.5 to 5.5	C, I		S, W, WF
24LC04SC	1M	4 Kbits (x8)	5 ms	400 kHz	2.5 to 5.5	C, I		S, W, WF
24LC08SC	1M	8 Kbits (x8)	5 ms	400 kHz	2.5 to 5.5	C, I		S, W, WF
24LC16SC	1M	16 Kbits (x8)	5 ms	400 kHz	2.5 to 5.5	C, I		S, W, WF
24LC32ASC	1M	32 Kbits (x8)	5 ms	400 kHz	2.5 to 5.5	C, I		S, W, WF
24LC64SC	1M	64 Kbits (x8)	5 ms	400 kHz	2.5 to 5.5	C, I		S, W, WF
24LC128SC	1M	128 Kbits (x8)	5 ms	400 kHz	2.5 to 5.5	C, I		S, W, WF
24LC256SC	1M	256 Kbits (x8)	5 ms	400 kHz	2.5 to 5.5	C, I		S, W, WF
24LC512SC	1M	512 Kbits (x8)	5 ms	400 kHz	2.5 to 5.5	C, I		S, W, WF
24AA01SC	1M	1 Kbit (x8)	5 ms	400 kHz	1.8 to 5.5	C		S, W, WF
24AA02SC	1M	2 Kbits (x8)	5 ms	400 kHz	1.8 to 5.5	C		S, W, WF
24AA04SC	1M	4 Kbits (x8)	5 ms	400 kHz	1.8 to 5.5	C		S, W, WF
24AA08SC	1M	8 Kbits (x8)	5 ms	400 kHz	1.8 to 5.5	C		S, W, WF
24AA16SC	1M	16 Kbits (x8)	5 ms	400 kHz	1.8 to 5.5	C		S, W, WF
24AA32ASC	1M	32 Kbits (x8)	5 ms	400 kHz	1.8 to 5.5	C		S, W, WF
24AA64SC	1M	64 Kbits (x8)	5 ms	400 kHz	1.8 to 5.5	C		S, W, WF
24AA128SC	1M	128 Kbits (x8)	5 ms	400 kHz	1.8 to 5.5	C		S, W, WF
24AA256SC	1M	256 Kbits (x8)	5 ms	400 kHz	1.8 to 5.5	C		S, W, WF
24AA512SC	1M	512 Kbits (x8)	5 ms	400 kHz	1.8 to 5.5	C		S, W, WF

Product	E/W Cycles	Density (Organization)	Page Size	Write Speed	Max. Clock Frequency	Operating Voltage (V)	Temps	Unique Features	Packages ⁽¹⁾
SPI™ Compatible Serial EEPROM Family – Page Write mode, HOLD pin, software enabled block write protection and hardware write-protect pin. Supports SPI™ modes 0, 3.									
25C040	1M	4 Kbits (x8)	16B	5 ms	3 MHz	4.5 to 5.5	I, E		P, SN, X/ST
25LC040	1M	4 Kbits (x8)	16B	5 ms	2 MHz	2.5 to 5.5	I		P, SN, X/ST
25AA040	1M	4 Kbits (x8)	16B	5 ms	1 MHz	1.8 to 5.5	I		P, SN, X/ST
25LC080A	1M	8 Kbits (x8)	16B	5 ms	10 MHz	2.5 to 5.5	I, E		P, SN, ST, MS
25AA080A	1M	8 Kbits (x8)	16B	5 ms	10 MHz	1.8 to 5.5	I		P, SN, ST, MS
25LC080B	1M	8 Kbits (x8)	32B	5 ms	10 MHz	2.5 to 5.5	I, E		P, SN, ST, MS
25AA080B	1M	8 Kbits (x8)	32B	5 ms	10 MHz	1.8 to 5.5	I		P, SN, ST, MS

NOTE 1. X/ST package code denotes rotated pinout.

**Memory
Family Products**

Product	E/W Cycles	Density (Organization)	Page Size	Write Speed	Max. Clock Frequency	Operating Voltage (V)	Temps	Unique Features	Packages ⁽¹⁾
SPI™ Compatible Serial EEPROM Family – Page Write mode, HOLD pin, software enabled block write protection and hardware write-protect pin. Supports SPI™ modes 0, 3. (continued)									
25LC160A	1M	16 Kbits (x8)	16B	5 ms	10 MHz	2.5 to 5.5	I, E		P, SN, ST, MS
25AA160A	1M	16 Kbits (x8)	16B	5 ms	10 MHz	1.8 to 5.5	I		P, SN, ST, MS
25LC160B	1M	16 Kbits (x8)	32B	5 ms	10 MHz	2.5 to 5.5	I, E		P, SN, ST, MS
25AA160B	1M	16 Kbits (x8)	32B	5 ms	10 MHz	1.8 to 5.5	I		P, SN, ST, MS
25C320	100K	32 Kbits (x8)	32B	5 ms	3 MHz	4.5 to 5.5	I, E		P, SN
25LC320	1M	32 Kbits (x8)	32B	5 ms	2 MHz	2.5 to 5.5	I, E		P, SN, X/ST
25AA320	1M	32 Kbits (x8)	32B	5 ms	1 MHz	1.8 to 5.5	I		P, SN, X/ST
25LC640	1M	64 Kbits (x8)	32B	5 ms	3 MHz	2.5 to 5.5	I, E		P, SN, X/ST
25AA640	1M	64 Kbits (x8)	32B	5 ms	1 MHz	1.8 to 5.5	I		P, SN, X/ST
25LC256	1M	256 Kbits (x8)	64B	5 ms	10 MHz	2.5 to 5.5	I, E		P, SN, ST, MF
25AA256	1M	256 Kbits (x8)	64B	5 ms	10 MHz	1.8 to 5.5	I		P, SN, ST, MF

NOTE 1. X/ST package code denotes rotated pinout.

Product	E/W Cycles	Density (Organization)	Write Speed	Max. Clock Frequency	Operating Voltage (V)	Temps	Unique Features	Packages
Identification Products (Application-Specific Products for Monitors, DRAM Modules, ACR Risers and Other Plug-And-Play Applications)								
24LC21A	1M	1 Kbit (x8)	10 ms	400 kHz	2.5 to 5.5	C, I	Completely implements DDC1™/DDC2™ interface for VESA monitor identification. Improved noise filter. Write protection pin plus "return to DDC1" feature.	P, SN
24LCS21A	1M	1 Kbit (x8)	10 ms	400 kHz	2.5 to 5.5	C, I	Same features as 24LC21A plus software enabled write-protect pin.	P, SN
24LCS22A	1M	2 Kbits (x8)	10 ms	400 kHz	2.5 to 5.5	I	Implements VESA E-EDID 1.3 for flat panels and projectors. Includes "return to DDC1" feature and software - enabled write protect pin.	P, SN
24LC024	1M	2 Kbits (x8)	10 ms	400 kHz	2.5 to 5.5	C, I	Addressable, hardware write protection for DRAM DIMM modules and other applications.	P, SN, ST, MS
24LC025	1M	2 Kbits (x8)	10 ms	400 kHz	2.5 to 5.5	C, I	Addressable. No write-protect.	P, SN, ST, MS
24AA52	1M	2 Kbits (x8)	10 ms	400 kHz	1.8 to 5.5	I	Addressable, hardware write protection and software write protection for lower half of the array. Designed for DRAM DIMM modules.	P, SN, ST, MS
24LCS52	1M	2 Kbits (x8)	10 ms	400 kHz	2.5 to 5.5	I		P, SN, ST, MS

FUTURE SERIAL ELECTRICALLY ERASABLE PROMS (EEPROM)

Part #	E/W Cycles	Density (Organization)	Page Size	Write Speed	Max. Clock Freq.	Operating Voltage (V)	Temps	Unique Features	Packages
SPI™ Compatible Serial EEPROM Family – Page Write mode, HOLD pin, software enabled block write protection and hardware write-protect pin									
25LC010A	1M	1 Kbit (x8)	16B	5 ms	10 MHz	2.5 to 5.5	I, E		P, SN, ST, MS, MC, OT
25AA010A	1M	1 Kbit (x8)	16B	5 ms	10 MHz	1.8 to 5.5	I		P, SN, ST, MS, MC, OT
25LC020A	1M	2 Kbits (x8)	16B	5 ms	10 MHz	2.5 to 5.5	I, E		P, SN, ST, MS, MC, OT
25AA020A	1M	2 Kbits (x8)	16B	5 ms	10 MHz	1.8 to 5.5	I		P, SN, ST, MS, MC, OT
25LC040A	1M	4 Kbits (x8)	16B	5 ms	10 MHz	2.5 to 5.5	I, E		P, SN, ST, MS, MC, OT
25AA040A	1M	4 Kbits (x8)	16B	5 ms	10 MHz	1.8 to 5.5	I		P, SN, ST, MS, MC, OT
25LC320A	1M	32 Kbits (x8)	32B	5 ms	10 MHz	2.5 to 5.5	I, E		P, SN, ST, MS
25AA320A	1M	32 Kbits (x8)	32B	5 ms	10 MHz	1.8 to 5.5	I, E		P, SN, ST, MS
25LC640A	1M	64 Kbits (x8)	32B	5 ms	10 MHz	2.5 to 5.5	I, E		P, SN, ST, MS
25AA640A	1M	64 Kbits (x8)	32B	5 ms	10 MHz	1.8 to 5.5	I		P, SN, ST, MS
25LC128	1M	128 Kbits (x8)	64B	5 ms	10 MHz	2.5 to 5.5	I, E		P, SN, ST, MS
25AA128	1M	128 Kbits (x8)	64B	5 ms	10 MHz	1.8 to 5.5	I		P, SN, ST, MS
25LC1024	1M	1 Mbit (x8)	256B	5 ms	20 MHz	2.5 to 5.5	I, E		P, SM, MF
25AA1024	1M	1 Mbit (x8)	256B	5 ms	20 MHz	1.8 to 5.5	I		P, SM, MF

DEVELOPMENT SYSTEMS

MPLAB® ICE 2000 and MPLAB® ICE 4000 Emulator Systems

Ordering MPLAB® ICE is as easy as 1, 2, and 3!

- NOTE 1:** Choose your PICmicro® MCU.
2: Choose your PICmicro® MCU package.
3: Find the right line on the next few pages for MPLAB® ICE part numbers. You're ready to order.

MPLAB® ICE is a modular emulator system with interchangeable components allowing the system to be easily configured to emulate different PICmicro® MCUs. Since this emulator supports package-specific emulation, customers need to know which device and package they intend to emulate. Then, the customer can use the *Cross Reference Parts List* on the following pages to identify the part numbers required to complete an MPLAB® ICE system. A complete system consists of:

- NOTE 1:** An emulator pod (including among other things the host-to-pod parallel cable and power supply)
2: A processor module
3: A device adapter
4: A transition socket

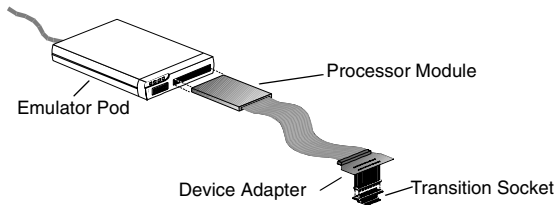

MPLAB® ICE 2000 Emulator

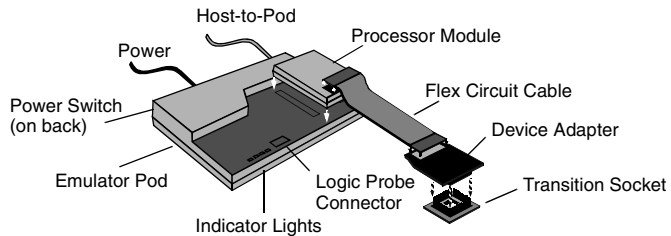

MPLAB® ICE 4000 Emulator

Components of the MPLAB® ICE emulator system are ordered as separate components. Knowing the terms will make it easy to order and use the MPLAB® ICE emulator system. Read more about each component:

1. Emulator Pod

The MPLAB® ICE 2000 and MPLAB® ICE 4000 are full-featured emulator pods containing a main board with an additional board for expanded trace memory and complex control logic. The MPLAB ICE 2000 pod comes with a standard parallel interface cable that connects the pod to the parallel port of the PC. MPLAB® ICE 4000 also includes a USB interface cable that connects the pod to the USB port. Power supplies are included.

2. Processor Module

The processor module is a PICmicro®, device-specific module that is inserted into the emulator pod. The processor module contains the emulator chip, logic, and low-voltage circuitry. A flex cable extends from the processor module and is connected to the device adapter at the target application.

3. Device Adapter

The device adapter provides a common interface for the PICmicro® MCU being emulated. This adapter contains a special device that provides an oscillator clock allowing the user to accurately emulate the RC characteristics of the PICmicro® MCU. The device adapter provides emulation support for standard DIP and PLCC styles. For emulation support of other packages, a transition socket is needed along with the device adapter.

4. Transition Socket

The transition sockets are available in various styles to allow the common device adapter to be translated to support surface-mount packages, such as SOIC, SSOP, PQFP, TQFP and MLF.

MPLAB® PM3 Programmers

MPLAB® PM3 Programmer (DV007004) is Microchip's production-rated programmer, which can be operated stand-alone or with a PC using MPLAB® IDE (included free). The programmer comes complete with the necessary accessories to connect to a host system, including a power supply and cables, giving the developer complete control over the programming session. The programmer requires a socket module (sold separately), which can be selected from the chart on the following pages by identifying the devices for programming and then picking the appropriate part number from the respective columns. MPLAB® PM3 has built-in ICSP™ programming capability.

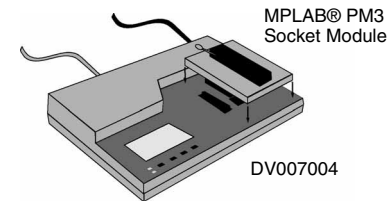

In-Circuit Debuggers: MPLAB® ICD 2

MPLAB® ICD 2 is a low-cost, flash-based development tool that connects between the PC and the designer's target board allowing direct in-circuit debugging of the PICmicro® target microcontroller. Programs can be executed in real time or single step, watch variables established, break points set, memory read/writes accomplished and more. The MPLAB® ICD 2 can also be used as a development programmer for the microcontrollers.

MPLAB® ICE 2000 and MPLAB® ICE 4000 Emulator Systems, PRO MATE® II Programmer Socket Modules, MPLAB® In-Circuit Debugger, Software Tools, Programmers and Demonstration Boards

		MPLAB® ICE 2000 System (1)			MPLAB® ICE 4000 System (2)								
Part Number	Lead Count/ Pkg Type	Processor Module	Device Adapters	Transition Socket	Processor Module	Device Adapters	Transition Socket	PRO MATE® II Socket Module (3,4)	MPLAB® PM3 Socket Module (8)	PICSTART® Plus (5)	MPLAB® ICD 2 (6)	MPLAB® CXX Compiler	Demonstration Boards or Evaluation Kits
Analog Interface Development Tools													
MCP2120	14P												DM163008
MCP2150	18P												DM163008
MCP25020	14P								AC164301				DV250501
MCP25020	14SO								AC164302				DV250501
MCP25025	14P								AC164301				DV250501
MCP25025	14SO								AC164302				DV250501
MCP25050	14P								AC164301				DV250501
MCP25050	14SO								AC164302				DV250501
MCP25055	14P								AC164301				DV250501
MCP25055	14SO								AC164302				DV250501
MCP2510	18P												DV251001
MCP2515	18P												DV251001
PICmicro® Microcontroller Development Tools													
PIC10F200	6OT							AC164037	AC164321	AC163020	AC162059 +XLT06SOT		DV164101 or DV164120 +AC163020
PIC10F200	8P							AC164037	AC164301	✓	AC162059		DV164101, DV164120
PIC10F202	6OT							AC164037	AC164321	AC163020	AC162059 +XLT06SOT		DV164101 or DV164120 +AC163020
PIC10F202	8P							AC164037	AC164301	✓	AC162059		DV164101, DV164120
PIC10F204	6OT							AC164037	AC164321	AC163020	AC162059 +XLT06SOT		DV164101 or DV164120 +AC163020
PIC10F204	8P							AC164037	AC164301	✓	AC162059		DV164101, DV164120
PIC10F206	6OT							AC164037	AC164321	AC163020	AC162059 +XLT06SOT		DV164101 or DV164120 +AC163020
PIC10F206	8P							AC164037	AC164301	✓	AC162059		DV164101, DV164120

NOTE: See complete list of notes on page 107.

Development Systems Products

MPLAB® ICE 2000 and MPLAB® ICE 4000 Emulator Systems, PRO MATE® II Programmer Socket Modules, MPLAB® In-Circuit Debugger, Software Tools, Programmers and Demonstration Boards (continued)

		MPLAB® ICE 2000 System (1)			MPLAB® ICE 4000 System (2)								
Part Number	Lead Count/ Pkg Type	Processor Module	Device Adapters	Transition Socket	Processor Module	Device Adapters	Transition Socket	PRO MATE® II Socket Module (3,4)	MPLAB® PM3 Socket Module (8)	PICSTART® Plus (5)	MPLAB® ICD 2 (6)	MPLAB® CXX Compiler	Demonstration Boards or Evaluation Kits
PICmicro® Microcontroller Development Tools (continued)													
PIC10F220	6OT							AC164037*	AC164321*	AC163020*	AC162059* +XLT06SOT		DV164101 or DV164120 +AC163020
PIC10F220	8P							AC164037*	AC164301*	✓*	AC162059*		DV164101, DV164120
PIC10F222	6OT							AC164037*	AC164321*	AC163020*	AC162059* +XLT06SOT		DV164101 or DV164120 +AC163020
PIC10F222	8P							AC164037*	AC164301*	✓*	AC162059*		DV164101, DV164120
PIC12C508	8P, 8JW	PCM16XA0	DVA12XP080					AC124001	AC164301	✓			DM163001, DVMCPA
PIC12C508	8SM	PCM16XA0	DVA12XP080	XLT08SO				AC124001	AC164312				
PIC12C508A	8P, 8JW	PCM16XA0	DVA12XP080					AC124001	AC164301	✓			DM163001, DVMCPA
PIC12C508A	8SM	PCM16XA0	DVA12XP080	XLT08SO				AC124001	AC164312				
PIC12C508A	8SN	PCM16XA0	DVA12XP080	XLT08SO				AC164026	AC164302				
PIC12C508A	8MF	PCM16XA0	DVA12XP080	XLT08DFN or XLT08DFN2				AC124001 +AC164032	AC164324**	AC164032			
PIC12C509	8P, 8JW	PCM16XA0	DVA12XP080					AC124001	AC164301	✓			DM163001, DVMCPA
PIC12C509	8SM	PCM16XA0	DVA12XP080	XLT08SO				AC124001	AC164312				
PIC12C509A	8P, 8JW	PCM16XA0	DVA12XP080					AC124001	AC164301	✓			DM163001, DVMCPA
PIC12C509A	8SM	PCM16XA0	DVA12XP080	XLT08SO				AC124001	AC164312				
PIC12C509A	8SN	PCM16XA0	DVA12XP080	XLT08SO				AC164026	AC164302				
PIC12C509A	8MF	PCM16XA0	DVA12XP080	XLT08DFN or XLT08DFN2				AC124001 +AC164032	AC164324**	AC164032			
PIC12C671	8P, 8JW	PCM12XA0	DVA12XP081					AC124001	AC164301	✓			
PIC12C671	8SM	PCM12XA0	DVA12XP081	XLT08SO				AC124001	AC164312				
PIC12C671	8MF	PCM12XA0	DVA12XP081	XLT08DFN or XLT08DFN2				AC124001 +AC164032	AC164324**	AC164032			
PIC12C672	8P, 8JW	PCM12XA0	DVA12XP081					AC124001	AC164301	✓			
PIC12C672	8SM	PCM12XA0	DVA12XP081	XLT08SO				AC124001	AC164312				
PIC12C672	8MF	PCM12XA0	DVA12XP081	XLT08DFN or XLT08DFN2				AC124001 +AC164032	AC164324**	AC164032			

NOTE: See complete list of notes on page 107.

MPLAB® ICE 2000 and MPLAB® ICE 4000 Emulator Systems, PRO MATE® II Programmer Socket Modules, MPLAB® In-Circuit Debugger, Software Tools, Programmers and Demonstration Boards (continued)

		MPLAB® ICE 2000 System (1)			MPLAB® ICE 4000 System (2)								
Part Number	Lead Count/ Pkg Type	Processor Module	Device Adapters	Transition Socket	Processor Module	Device Adapters	Transition Socket	PRO MATE® II Socket Module (3,4)	MPLAB® PM3 Socket Module (8)	PICSTART® Plus (5)	MPLAB® ICD 2 (6)	MPLAB® CXX Compiler	Demonstration Boards or Evaluation Kits
PICmicro® Microcontroller Development Tools (continued)													
PIC12CE518	8P, 8JW	PCM16XA0	DVA12XP080					AC124001	AC164301	✓			
PIC12CE518	8SM	PCM16XA0	DVA12XP080	XLT08SO				AC124001	AC164312				
PIC12CE518	8SN	PCM16XA0	DVA12XP080	XLT08SO				AC164026	AC164302				
PIC12CE519	8P, 8JW	PCM16XA0	DVA12XP080					AC124001	AC164301	✓			
PIC12CE519	8SM	PCM16XA0	DVA12XP080	XLT08SO				AC124001	AC164312				
PIC12CE519	8SN	PCM16XA0	DVA12XP080	XLT08SO				AC164026	AC164302				
PIC12CE673	8P, 8JW	PCM12XA0	DVA12XP081					AC124001	AC164301	✓			
PIC12CE674	8P, 8JW	PCM12XA0	DVA12XP081					AC124001	AC164301	✓			
PIC12F508	8P	PCM16XA0	DVA12XP080					AC124001	AC164301	✓	AC162059		DV164101, DM163014, DV164120, DM163029
PIC12F508	8SN	PCM16XA0	DVA12XP080	XLT08SO				AC164026	AC164302		AC162059 +XLT08SO		
PIC12F508	8ST	PCM16XA0	DVA12XP080						AC164306				
PIC12F508	8MS	PCM16XA0	DVA12XP080						AC164325**				
PIC12F509	8P	PCM16XA0	DVA12XP080					AC124001	AC164301	✓	AC162059		DM163014, DV164101, DV164120, DM163029
PIC12F509	8SN	PCM16XA0	DVA12XP080	XLT08SO				AC164026	AC164302		AC162059 +XLT08SO		
PIC12F509	8ST	PCM16XA0	DVA12XP080						AC164306				
PIC12F509	8MS	PCM16XA0	DVA12XP080						AC164325**				
PIC12F510	8P							AC124001*	AC164301*		AC162070*		DV164101*, DV164120, DM163029
PIC12F510	8SN							AC164026*	AC164302*				
PIC12F510	8MS								AC164325**				
PIC12F510	8MF								AC164324**				

NOTE: See complete list of notes on page 107.

**Development
Systems Products**

MPLAB® ICE 2000 and MPLAB® ICE 4000 Emulator Systems, PRO MATE® II Programmer Socket Modules, MPLAB® In-Circuit Debugger, Software Tools, Programmers and Demonstration Boards (continued)

		MPLAB® ICE 2000 System (1)			MPLAB® ICE 4000 System (2)								
Part Number	Lead Count/ Pkg Type	Processor Module	Device Adapters	Transition Socket	Processor Module	Device Adapters	Transition Socket	PRO MATE® II Socket Module (3,4)	MPLAB® PM3 Socket Module (8)	PICSTART® Plus (5)	MPLAB® ICD 2 (6)	MPLAB® CXX Compiler	Demonstration Boards or Evaluation Kits
PICmicro® Microcontroller Development Tools (continued)													
PIC12F629	8P	PCM12XB0	DVA12XP081					AC124001	AC164301	✓	AC162050		DM163014, DV164101, DV164120, DM163029
PIC12F629	8SN	PCM12XB0	DVA12XP081	XLT08SO				AC164026	AC164302		AC162050 +XLT08SO		
PIC12F629	8MF	PCM12XB0	DVA12XP081	XLT08DFN or XLT08DFN2				AC124001 +AC164032	AC164324**	AC164032	AC162050 +XLT08DFN or XLT08DFN2		
PIC12F635	8P	PCM16YM0	DVA1004**	ACICE0201				AC124001	AC164301	✓	AC162057		DM163014, DV164101, DV164120, DM163029
PIC12F635	8SN	PCM16YM0	DVA1004**	XLT08SO				AC164026	AC164302		AC162057 +XLT08SO		
PIC12F635	8MF	PCM16YM0	DVA1004**	XLT08DFN or XLT08DFN2				AC124001 +AC164032	AC164324**	AC164032	AC162050 +XLT08DFN or XLT08DFN2		
PIC12F675	8P	PCM12XB0	DVA12XP081					AC124001	AC164301	✓	AC162050		DM163014, DV164101, DV164120, DM163029
PIC12F675	8SN	PCM12XB0	DVA12XP081	XLT08SO				AC164026	AC164302		AC162050 +XLT08SO		
PIC12F675	8MF	PCM12XB0	DVA12XP081	XLT08DFN or XLT08DFN2				AC124001 +AC164032	AC164324**	AC164032	AC162050 +XLT08DFN or XLT08DFN2		
PIC12F683	8P	PCM12XC0	DVA1004**	ACICE0201				AC124001	AC164301	✓	AC162058		DM163014, DV164101, DV164120, DM163029
PIC12F683	8SN	PCM12XC0	DVA1004**	XLT08SO				AC164026	AC164302		AC162058 +XLT08SO		
PIC12F683	8MF	PCM12XC0	DVA1004**	XLT08DFN or XLT08DFN2				AC124001 +AC164032	AC164324**	AC164032	AC162058 +XLT08DFN or XLT08DFN2		
PIC14000	28SP, 28JW	PCM14XA0	DVA14XP280					AC144001		✓			
PIC14000	28SO	PCM14XA0	DVA14XP280	XLT28SO				AC144002					
PIC14000	28SS	PCM14XA0	DVA14XP280	XLT28SS				AC144002					
PIC16C52	18P	PCM16XA0	DVA16XP180					AC164001	AC164301	✓			DM163001
PIC16C52	18SO	PCM16XA0	DVA16XP180	XLT18SO				AC164002	AC164302				

NOTE: See complete list of notes on page 107.

MPLAB® ICE 2000 and MPLAB® ICE 4000 Emulator Systems, PRO MATE® II Programmer Socket Modules, MPLAB® In-Circuit Debugger, Software Tools, Programmers and Demonstration Boards (continued)

		MPLAB® ICE 2000 System (1)			MPLAB® ICE 4000 System (2)								
Part Number	Lead Count/ Pkg Type	Processor Module	Device Adapters	Transition Socket	Processor Module	Device Adapters	Transition Socket	PRO MATE® II Socket Module (3,4)	MPLAB® PM3 Socket Module (8)	PICSTART® Plus (5)	MPLAB® ICD 2 (6)	MPLAB® CXX Compiler	Demonstration Boards or Evaluation Kits
PICmicro® Microcontroller Development Tools (continued)													
PIC16C54/54A/54C	18P, 18JW	PCM16XA0	DVA16XP180					AC164001	AC164301	✓			DM163001
PIC16C54/54A/54C	18SO	PCM16XA0	DVA16XP180	XLT18SO				AC164002	AC164302				
PIC16C54/54A/54C	20SS	PCM16XA0	DVA16XP180	XLT20SS				AC164015	AC164307				
PIC16C55/55A	28P, 28JW	PCM16XA0	DVA16XP280	XLT28XP				AC164001	AC164301	✓			DM163001
PIC16C55/55A	28SP	PCM16XA0	DVA16XP280					AC164001	AC164301	✓			DM163001
PIC16C55/55A	28SO	PCM16XA0	DVA16XP280	XLT28SO				AC164002	AC164302				
PIC16C55/55A	28SS	PCM16XA0	DVA16XP280	XLT28SS2				AC164015	AC164307				
PIC16C56/56A	18P, 18JW	PCM16XA0	DVA16XP180					AC164001	AC164301	✓			DM163001
PIC16C56/56A	18SO	PCM16XA0	DVA16XP180	XLT18SO				AC164002	AC164302				
PIC16C56/56A	20SS	PCM16XA0	DVA16XP180	XLT20SS				AC164015	AC164307				
PIC16C57/57C	28P, 28JW	PCM16XA0	DVA16XP280	XLT28XP				AC164001	AC164301	✓			DM163001
PIC16C57/57C	28SP	PCM16XA0	DVA16XP280					AC164001	AC164301	✓			DM163001
PIC16C57/57C	28SO	PCM16XA0	DVA16XP280	XLT28SO				AC164002	AC164302				
PIC16C57/57C	28SS	PCM16XA0	DVA16XP280	XLT28SS2				AC164015	AC164307				
PIC16C58A/58B	18P, 18JW	PCM16XA0	DVA16XP180					AC164001	AC164301	✓			DM163001
PIC16C58A/58B	18SO	PCM16XA0	DVA16XP180	XLT18SO				AC164002	AC164302				
PIC16C58A/58B	20SS	PCM16XA0	DVA16XP180	XLT20SS				AC164015	AC164307				
PIC16C62A	28P, 28JW	PCM16XB1	DVA16XP282					AC164012	AC164301	✓			DM163022
PIC16C62A	28SO	PCM16XB1	DVA16XP282	XLT28SO				AC164017	AC164302				
PIC16C62A	28SS	PCM16XB1	DVA16XP282	XLT28SS				AC164021	AC164307				
PIC16C62B	28SP, 28JW	PCM16XE1	DVA16XP282					AC164012	AC164301	✓			DM163022
PIC16C62B	28ML	PCM16XE1	DVA16XP282	XLT28QFN4				AC164012 +AC164031	AC164322	AC164031			
PIC16C62B	28SO	PCM16XE1	DVA16XP282	XLT28SO				AC164017	AC164302				
PIC16C62B	28SS	PCM16XE1	DVA16XP282	XLT28SS				AC164021	AC164307				
PIC16C63	28SP, 28JW	PCM16XB1	DVA16XP282					AC164012	AC164301	✓			DM163022, DVMCPA
PIC16C63	28SO	PCM16XB1	DVA16XP282	XLT28SO				AC164017	AC164302				
PIC16C63A	28SP, 28JW	PCM16XE1	DVA16XP282					AC164012	AC164301	✓			DM163022
PIC16C63A	28ML	PCM16XE1	DVA16XP282	XLT28QFN4				AC164012 +AC164031	AC164322	AC164031			
PIC16C63A	28SO	PCM16XE1	DVA16XP282	XLT28SO				AC164017	AC164302				
PIC16C63A	28SS	PCM16XE1	DVA16XP282	XLT28SS				AC164021	AC164307				

NOTE: See complete list of notes on page 107.

**Development
Systems Products**

MPLAB® ICE 2000 and MPLAB® ICE 4000 Emulator Systems, PRO MATE® II Programmer Socket Modules, MPLAB® In-Circuit Debugger, Software Tools, Programmers and Demonstration Boards (continued)

		MPLAB® ICE 2000 System (1)			MPLAB® ICE 4000 System (2)								
Part Number	Lead Count/ Pkg Type	Processor Module	Device Adapters	Transition Socket	Processor Module	Device Adapters	Transition Socket	PRO MATE® II Socket Module (3,4)	MPLAB® PM3 Socket Module (8)	PICSTART® Plus (5)	MPLAB® ICD 2 (6)	MPLAB® CXX Compiler	Demonstration Boards or Evaluation Kits
PICmicro® Microcontroller Development Tools (continued)													
PIC16C64A	40P, 40JW	PCM16XB1	DVA16XP401					AC164012	AC164301	✓			DM163022
PIC16C64A	44L	PCM16XB1	DVA16XL441					AC164013	AC164309				
PIC16C64A	44PQ	PCM16XB1	DVA16PQ441	XLT44PT or XLT44PT3				AC164014	AC164311				
PIC16C64A	44PT	PCM16XB1	DVA16PQ441	XLT44PT or XLT44PT3				AC164020	AC164305				
PIC16C65A	40P, 40JW	PCM16XB1	DVA16XP401					AC164012	AC164301	✓			DM163022
PIC16C65A	44L	PCM16XB1	DVA16XL441					AC164013	AC164309				
PIC16C65A	44PQ	PCM16XB1	DVA16PQ441	XLT44PT or XLT44PT3				AC164014	AC164311				
PIC16C65A	44PT	PCM16XB1	DVA16PQ441	XLT44PT or XLT44PT3				AC164020	AC164305				
PIC16C65B	40P, 40JW	PCM16XE1	DVA16XP401					AC164012	AC164301	✓			DM163022
PIC16C65B	44L	PCM16XE1	DVA16XL441					AC164013	AC164309				
PIC16C65B	44PQ	PCM16XE1	DVA16PQ441	XLT44PT or XLT44PT3				AC164014	AC164311				
PIC16C65B	44PT	PCM16XE1	DVA16PQ441	XLT44PT or XLT44PT3				AC164020	AC164305				
PIC16C66	28SP, 28JW	PCM16XE1	DVA16XP282					AC164012	AC164301	✓			DM163022
PIC16C66	28SO	PCM16XE1	DVA16XP282	XLT28SO				AC164017	AC164302				
PIC16C67	40P, 40JW	PCM16XE1	DVA16XP401					AC164012	AC164301	✓			DM163022
PIC16C67	44L	PCM16XE1	DVA16XL441					AC164013	AC164309				
PIC16C67	44PQ	PCM16XE1	DVA16PQ441	XLT44PT or XLT44PT3				AC164014	AC164311				
PIC16C67	44PT	PCM16XE1	DVA16PQ441	XLT44PT or XLT44PT3				AC164020	AC164305				
PIC16C71	18P, 18JW	PCM16XF0	DVA16XP180					AC164010	AC164301	✓			DM163001
PIC16C71	18SO	PCM16XF0	DVA16XP180	XLT18SO				AC164010	AC164302				
PIC16C72	28SP, 28JW	PCM16XB1	DVA16XP282					AC164012	AC164301	✓			DM163022
PIC16C72	28SO	PCM16XB1	DVA16XP282	XLT28SO				AC164017	AC164302				
PIC16C72	28SS	PCM16XB1	DVA16XP282	XLT28SS				AC164021	AC164307				

NOTE: See complete list of notes on page 107.

MPLAB® ICE 2000 and MPLAB® ICE 4000 Emulator Systems, PRO MATE® II Programmer Socket Modules, MPLAB® In-Circuit Debugger, Software Tools, Programmers and Demonstration Boards (continued)

		MPLAB® ICE 2000 System (1)			MPLAB® ICE 4000 System (2)								
Part Number	Lead Count/ Pkg Type	Processor Module	Device Adapters	Transition Socket	Processor Module	Device Adapters	Transition Socket	PRO MATE® II Socket Module (3,4)	MPLAB® PM3 Socket Module (8)	PICSTART® Plus (5)	MPLAB® ICD 2 (6)	MPLAB® CXX Compiler	Demonstration Boards or Evaluation Kits
PICmicro® Microcontroller Development Tools (continued)													
PIC16C72A	28SP, 28JW	PCM16XE1	DVA16XP282					AC164012	AC164301	✓			DM163022
PIC16C72A	28ML	PCM16XE1	DVA16XP282	XLT28QFN4				AC164012 +AC164031	AC164322	AC164031			
PIC16C72A	28SO	PCM16XE1	DVA16XP282	XLT28SO				AC164017	AC164302				
PIC16C72A	28SS	PCM16XE1	DVA16XP282	XLT28SS				AC164021	AC164307				
PIC16C73A	28SP, 28JW	PCM16XB1	DVA16XP282					AC164012	AC164301	✓			DM163022
PIC16C73A	28SO	PCM16XB1	DVA16XP282	XLT28SO				AC164017	AC164302				
PIC16C73B	28SP, 28JW	PCM16XE1	DVA16XP282					AC164012	AC164301	✓			DM163022
PIC16C73B	28ML	PCM16XE1	DVA16XP282	XLT28QFN4				AC164012 +AC164031	AC164322	AC164031			
PIC16C73B	28SO	PCM16XE1	DVA16XP282	XLT28SO				AC164017	AC164302				
PIC16C73B	28SS	PCM16XE1	DVA16XP282	XLT28SS				AC164021	AC164307				
PIC16C74A	40P, 40JW	PCM16XB1	DVA16XP401					AC164012	AC164301	✓			DM163022
PIC16C74A	44L	PCM16XB1	DVA16XL441					AC164013	AC164309				
PIC16C74A	44PQ	PCM16XB1	DVA16PQ441	XLT44PT or XLT44PT3				AC164014	AC164311				
PIC16C74A	44PT	PCM16XB1	DVA16PQ441	XLT44PT or XLT44PT3				AC164020	AC164305				
PIC16C74B	40P, 40JW	PCM16XE1	DVA16XP401					AC164012	AC164301	✓			DM163022
PIC16C74B	44L	PCM16XE1	DVA16XL441					AC164013	AC164309				
PIC16C74B	44PQ	PCM16XE1	DVA16PQ441	XLT44PT or XLT44PT3				AC164014	AC164311				
PIC16C74B	44PT	PCM16XE1	DVA16PQ441	XLT44PT or XLT44PT3				AC164020	AC164305				
PIC16C76	28SP, 28JW	PCM16XE1	DVA16XP282					AC164012	AC164301	✓			DM163022
PIC16C76	28SO	PCM16XE1	DVA16XP282	XLT28SO				AC164017	AC164302				
PIC16C77	40P, 40JW	PCM16XE1	DVA16XP401					AC164012	AC164301	✓			DM163022
PIC16C77	44L	PCM16XE1	DVA16XL441					AC164013	AC164309				
PIC16C77	44PQ	PCM16XE1	DVA16PQ441	XLT44PT or XLT44PT3				AC164014	AC164311				
PIC16C77	44PT	PCM16XE1	DVA16PQ441	XLT44PT or XLT44PT3				AC164020	AC164305				
PIC16C432	20P, 20JW	PCM16YB0	DVA16XP201					AC164029	AC164301				DM163005
PIC16C432	20SS	PCM16YB0	DVA16XP201	XLT20SS1				AC164029	AC164307				DM163007, DM163011

NOTE: See complete list of notes on page 107.

**Development
Systems Products**

MPLAB® ICE 2000 and MPLAB® ICE 4000 Emulator Systems, PRO MATE® II Programmer Socket Modules, MPLAB® In-Circuit Debugger, Software Tools, Programmers and Demonstration Boards (continued)

		MPLAB® ICE 2000 System (1)			MPLAB® ICE 4000 System (2)								
Part Number	Lead Count/ Pkg Type	Processor Module	Device Adapters	Transition Socket	Processor Module	Device Adapters	Transition Socket	PRO MATE® II Socket Module (3,4)	MPLAB® PM3 Socket Module (8)	PICSTART® Plus (5)	MPLAB® ICD 2 (6)	MPLAB® CXX Compiler	Demonstration Boards or Evaluation Kits
PICmicro® Microcontroller Development Tools (continued)													
PIC16C433	18P, 18JW	PCM16YC0	DVA16XP185					AC164030	AC164301				DM163005
PIC16C433	18SO	PCM16YC0	DVA16XP185	XLT18SO				AC164030	AC164307				
PIC16C505	14P, 14JW	PCM16XA0	DVA16XP140					AC124001	AC164301	✓			
PIC16C505	14SL	PCM16XA0	DVA16XP140	XLT14SO				AC164026	AC164302				
PIC16C554	18P, 18JW	PCM16XC0	DVA16XP180					AC164010	AC164301	✓			DM163001
PIC16C554	18SO	PCM16XC0	DVA16XP180	XLT18SO				AC164010	AC164302				
PIC16C554	20SS	PCM16XC0	DVA16XP180	XLT20SS				AC164018	AC164307				
PIC16C557	28P							AC164001	AC164301				
PIC16C557	28SO							AC164002	AC164302				
PIC16C558	18P, 18JW	PCM16XC0	DVA16XP180					AC164010	AC164301	✓			DM163001
PIC16C558	18SO	PCM16XC0	DVA16XP180	XLT18SO				AC164010	AC164302				
PIC16C558	20SS	PCM16XC0	DVA16XP180	XLT20SS				AC164018	AC164307				
PIC16C620/620A	18P, 18JW	PCM16XC0	DVA16XP180					AC164010	AC164301	✓			DM163001
PIC16C620/620A	18SO	PCM16XC0	DVA16XP180	XLT18SO				AC164010	AC164302				
PIC16C620/620A	20SS	PCM16XC0	DVA16XP180	XLT20SS				AC164018	AC164307				
PIC16C621/621A	18P, 18JW	PCM16XC0	DVA16XP180					AC164010	AC164301	✓			DM163001
PIC16C621/621A	18SO	PCM16XC0	DVA16XP180	XLT18SO				AC164010	AC164302				
PIC16C621/621A	20SS	PCM16XC0	DVA16XP180	XLT20SS				AC164018	AC164307				
PIC16C622/622A	18P, 18JW	PCM16XC0	DVA16XP180					AC164010	AC164301	✓			DM163001
PIC16C622/622A	18SO	PCM16XC0	DVA16XP180	XLT18SO				AC164010	AC164302				
PIC16C622/622A	20SS	PCM16XC0	DVA16XP180	XLT20SS				AC164018	AC164307				
PIC16C642	28SP, 28JW	PCM16XD0	DVA16XP282					AC164012	AC164301	✓			DM163022
PIC16C642	28SO	PCM16XD0	DVA16XP282	XLT28SO				AC164017	AC164302				

NOTE: See complete list of notes on page 107.

MPLAB® ICE 2000 and MPLAB® ICE 4000 Emulator Systems, PRO MATE® II Programmer Socket Modules, MPLAB® In-Circuit Debugger, Software Tools, Programmers and Demonstration Boards (continued)

		MPLAB® ICE 2000 System (1)			MPLAB® ICE 4000 System (2)								
Part Number	Lead Count/ Pkg Type	Processor Module	Device Adapters	Transition Socket	Processor Module	Device Adapters	Transition Socket	PRO MATE® II Socket Module (3,4)	MPLAB® PM3 Socket Module (8)	PICSTART® Plus (5)	MPLAB® ICD 2 (6)	MPLAB® CXX Compiler	Demonstration Boards or Evaluation Kits
PICmicro® Microcontroller Development Tools (continued)													
PIC16C662	40P, 40JW	PCM16XD0	DVA16XP401					AC164012	AC164301	✓			DM163022
PIC16C662	44L	PCM16XD0	DVA16XL441					AC164013	AC164309				
PIC16C662	44PQ	PCM16XD0	DVA16PQ441	XLT44PT or XLT44PT3				AC164014	AC164311				
PIC16C662	44PT	PCM16XD0	DVA16PQ441	XLT44PT or XLT44PT3				AC164020	AC164305				
PIC16C710	18P, 18JW	PCM16XF0	DVA16XP180					AC164010	AC164301	✓			DM163001
PIC16C710	18SO	PCM16XF0	DVA16XP180	XLT18SO				AC164010	AC164302				
PIC16C710	20SS	PCM16XF0	DVA16XP180	XLT20SS				AC164018	AC164307				
PIC16C711	18P, 18JW	PCM16XF0	DVA16XP180					AC164010	AC164301	✓			DM163001
PIC16C711	18SO	PCM16XF0	DVA16XP180	XLT18SO				AC164010	AC164302				
PIC16C711	20SS	PCM16XF0	DVA16XP180	XLT20SS				AC164018	AC164307				
PIC16C712	18P, 18JW	PCM16XE1	DVA16XP182					AC164010	AC164301	✓			DM163001
PIC16C712	18SO	PCM16XE1	DVA16XP182	XLT18SO				AC164010	AC164302				
PIC16C712	20SS	PCM16XE1	DVA16XP182	XLT20SS				AC164018	AC164307				
PIC16C715	18P, 18JW	PCM16XG0	DVA16XP180					AC164010	AC164301	✓			DM163001
PIC16C715	18SO	PCM16XG0	DVA16XP180	XLT18SO				AC164010	AC164302				
PIC16C715	20SS	PCM16XG0	DVA16XP180	XLT20SS				AC164018	AC164307				
PIC16C716	18P, 18JW	PCM16XE1	DVA16XP182					AC164010	AC164301	✓			DM163001
PIC16C716	18SO	PCM16XE1	DVA16XP182	XLT18SO				AC164010	AC164302				
PIC16C716	20SS	PCM16XE1	DVA16XP182	XLT20SS				AC164018	AC164307				
PIC16C717	18P, 18JW	PCM16XN1	DVA18XP180					AC164010	AC164301	✓			DM163001
PIC16C717	18SO	PCM16XN1	DVA18XP180	XLT18SO				AC164010	AC164302				
PIC16C717	20SS	PCM16XN1	DVA18XP180	XLT20SS				AC164018	AC164307				
PIC16C745	28SP, 28JW	PCM16XQ1	DVA16XP282					AC164012	AC164301	✓			DM163010
PIC16C745	28SO	PCM16XQ1	DVA16XP282	XLT28SO				AC164017	AC164302				
PIC16C765	40P, 40JW	PCM16XQ1	DVA16XP401					AC164012	AC164301	✓			DM163010
PIC16C765	44L	PCM16XQ1	DVA16XL441					AC164013	AC164309				
PIC16C765	44PT	PCM16XQ1	DVA16PQ441	XLT44PT or XLT44PT3				AC164020	AC164305				

NOTE: See complete list of notes on page 107.

**Development
Systems Products**

MPLAB® ICE 2000 and MPLAB® ICE 4000 Emulator Systems, PRO MATE® II Programmer Socket Modules, MPLAB® In-Circuit Debugger, Software Tools, Programmers and Demonstration Boards (continued)

		MPLAB® ICE 2000 System (1)			MPLAB® ICE 4000 System (2)								
Part Number	Lead Count/ Pkg Type	Processor Module	Device Adapters	Transition Socket	Processor Module	Device Adapters	Transition Socket	PRO MATE® II Socket Module (3,4)	MPLAB® PM3 Socket Module (8)	PICSTART® Plus (5)	MPLAB® ICD 2 (6)	MPLAB® CXX Compiler	Demonstration Boards or Evaluation Kits
PICmicro® Microcontroller Development Tools (continued)													
PIC16C770	20P, 20JW	PCM16XN1	DVA16XP200					AC164028	AC164301	✓			DM163001
PIC16C770	20SO	PCM16XN1	DVA16XP200	XLT20SO1				AC164028	AC164302				
PIC16C770	20SS	PCM16XN1	DVA16XP200	XLT20SS1				AC164018	AC164307				
PIC16C771	20P, 20JW	PCM16XN1	DVA16XP200					AC164028	AC164301	✓			DM163001
PIC16C771	20SO	PCM16XN1	DVA16XP200	XLT20SO1				AC164028	AC164302				
PIC16C771	20SS	PCM16XN1	DVA16XP200	XLT20SS1				AC164018	AC164307				
PIC16C773	28SP, 28JW	PCM16XL0	DVA16XP282					AC164012	AC164301	✓			DM163022
PIC16C773	28SO	PCM16XL0	DVA16XP282	XLT28SO				AC164017	AC164302				
PIC16C773	28SS	PCM16XL0	DVA16XP282	XLT28SS				AC164021	AC164307				
PIC16C774	40P, 40JW	PCM16XL0	DVA16XP401					AC164012	AC164301	✓			DM163022
PIC16C774	44L	PCM16XL0	DVA16XL441					AC164013	AC164309				
PIC16C774	44PQ	PCM16XL0	DVA16PQ441	XLT44PT or XLT44PT3				AC164014	AC164311				
PIC16C774	44PT	PCM16XL0	DVA16PQ441	XLT44PT or XLT44PT3				AC164020	AC164305				
PIC16C781	20P, 20JW	PCM16XW0	DVA16XP202					AC164028	AC164301	✓			DM163012
PIC16C781	20SO	PCM16XW0	DVA16XP202	XLT20SO1				AC164028	AC164302				
PIC16C781	20SS	PCM16XW0	DVA16XP202	XLT20SS1				AC164018	AC164307				
PIC16C782	20P, 20JW	PCM16XW0	DVA16XP202					AC164028	AC164301	✓			DM163012
PIC16C782	20SO	PCM16XW0	DVA16XP202	XLT20SO1				AC164028	AC164302				
PIC16C782	20SS	PCM16XW0	DVA16XP202	XLT20SS1				AC164018	AC164307				
PIC16C923	64SP	PCM16XJ0	DVA16XP640					AC164025					
PIC16C923	64PT	PCM16XJ0	DVA16PQ640	XLT64PT1				AC164023	AC164319				
PIC16C923	68L, 68CL	PCM16XJ0	DVA16XL680					AC164022	AC164308	AC164024			DM163003
PIC16C924	64SP	PCM16XJ0	DVA16XP640					AC164025					
PIC16C924	64PT	PCM16XJ0	DVA16PQ640	XLT64PT1				AC164023	AC164319				
PIC16C924	68L, 68CL	PCM16XJ0	DVA16XL680					AC164022	AC164308	AC164024			DM163003
PIC16C925	64PT	PCM16XT0	DVA16PQ640	XLT64PT1				AC164023	AC164319				
PIC16C925	68L, 68CL	PCM16XT0	DVA16XL680					AC164022	AC164308	AC164024			DM163003
PIC16C926	64PT	PCM16XT0	DVA16PQ640	XLT64PT1				AC164023	AC164319				
PIC16C926	68L, 68CL	PCM16XT0	DVA16XL680					AC164022	AC164308	AC164024			DM163003

NOTE: See complete list of notes on page 107.

MPLAB® ICE 2000 and MPLAB® ICE 4000 Emulator Systems, PRO MATE® II Programmer Socket Modules, MPLAB® In-Circuit Debugger, Software Tools, Programmers and Demonstration Boards (continued)

		MPLAB® ICE 2000 System (1)			MPLAB® ICE 4000 System (2)								
Part Number	Lead Count/ Pkg Type	Processor Module	Device Adapters	Transition Socket	Processor Module	Device Adapters	Transition Socket	PRO MATE® II Socket Module (3,4)	MPLAB® PM3 Socket Module (8)	PICSTART® Plus (5)	MPLAB® ICD 2 (6)	MPLAB® CXX Compiler	Demonstration Boards or Evaluation Kits
PICmicro® Microcontroller Development Tools (continued)													
PIC16CE623	18P, 18JW	PCM16XC0	DVA16XP180					AC164010	AC164301	✓			DM163001
PIC16CE623	18SO	PCM16XC0	DVA16XP180	XLT18SO				AC164010	AC164302				
PIC16CE623	20SS	PCM16XC0	DVA16XP180	XLT20SS				AC164018	AC164307				
PIC16CE624	18P, 18JW	PCM16XC0	DVA16XP180					AC164010	AC164301	✓			DM163001
PIC16CE624	18SO	PCM16XC0	DVA16XP180	XLT18SO				AC164010	AC164302				
PIC16CE624	20SS	PCM16XC0	DVA16XP180	XLT20SS				AC164018	AC164307				
PIC16CE625	18P, 18JW	PCM16XC0	DVA16XP180					AC164010	AC164301	✓			DM163001
PIC16CE625	18SO	PCM16XC0	DVA16XP180	XLT18SO				AC164010	AC164302				
PIC16CE625	20SS	PCM16XC0	DVA16XP180	XLT20SS				AC164018	AC164307				
PIC16F54	18P	PCM16XA0	DVA16XP180					AC164001	AC164301	✓			DV164101, DM163001, DV164120
PIC16F54	18SO	PCM16XA0	DVA16XP180	XLT18SO				AC164002	AC164302				
PIC16F54	20SS	PCM16XA0	DVA16XP180	XLT20SS				AC164015	AC164307				
PIC16F57	28P	PCM16XA0	DVA16XP280	XLT28XP				AC164001	AC164301				
PIC16F57	28SP	PCM16XA0	DVA16XP280					AC164001	AC164301	✓			DV164101, DM163001, DV164120
PIC16F57	28SO	PCM16XA0	DVA16XP280	XLT28SO				AC164002	AC164302				
PIC16F57	28SS	PCM16XA0	DVA16XP280	XLT28SS2				AC164015	AC164307				
PIC16F59	40P							AC164038	AC164301		✓*		DV164101, DV164120
PIC16F59	44PT								AC164305		✓*		
PIC16F72	28SP, 28JW	PCM16XS2	DVA16XP282					AC164012	AC164301	✓			DM163022
PIC16F72	28SO	PCM16XS2	DVA16XP282	XLT28SO				AC164017	AC164302				
PIC16F72	28SS	PCM16XS2	DVA16XP282	XLT28SS				AC164021	AC164307				
PIC16F72	28ML	PCM16XS2	DVA16XP282	XLT28QFN4				AC164012 +AC164031	AC164322	AC164031			
PIC16F73	28SP, 28JW	PCM16XS2	DVA16XP282					AC164012	AC164301	✓	✓*		DM163022
PIC16F73	28ML	PCM16XS2	DVA16XP282	XLT28QFN4				AC164012 +AC164031	AC164322	AC164031	✓*		
PIC16F73	28SO	PCM16XS2	DVA16XP282	XLT28SO				AC164017	AC164302		✓*		
PIC16F73	28SS	PCM16XS2	DVA16XP282	XLT28SS				AC164021	AC164307		✓*		

NOTE: See complete list of notes on page 107.

**Development
Systems Products**

MPLAB® ICE 2000 and MPLAB® ICE 4000 Emulator Systems, PRO MATE® II Programmer Socket Modules, MPLAB® In-Circuit Debugger, Software Tools, Programmers and Demonstration Boards (continued)

		MPLAB® ICE 2000 System (1)			MPLAB® ICE 4000 System (2)								
Part Number	Lead Count/ Pkg Type	Processor Module	Device Adapters	Transition Socket	Processor Module	Device Adapters	Transition Socket	PRO MATE® II Socket Module (3,4)	MPLAB® PM3 Socket Module (8)	PICSTART® Plus (5)	MPLAB® ICD 2 (6)	MPLAB® CXX Compiler	Demonstration Boards or Evaluation Kits
PICmicro® Microcontroller Development Tools (continued)													
PIC16F74	40P	PCM16XS2	DVA16XP401					AC164012	AC164301	✓	✓*		DM163022
PIC16F74	44L	PCM16XS2	DVA16XL441					AC164013	AC164309		✓*		
PIC16F74	44PT	PCM16XS2	DVA16PQ441	XLT44PT or XLT44PT3				AC164020	AC164305		✓*		
PIC16F74	44ML	PCM16XS2	DVA16XL441	XLT44QFN2				AC164012 +AC164034	AC164322	AC164034	✓*		
PIC16F76	28SP, 28JW	PCM16XS2	DVA16XP282					AC164012	AC164301	✓	✓*		DM163022
PIC16F76	28ML	PCM16XS2	DVA16XP282	XLT28QFN4				AC164012 +AC164031	AC164322	AC164031	✓*		
PIC16F76	28SO	PCM16XS2	DVA16XP282	XLT28SO				AC164017	AC164302		✓*		
PIC16F76	28SS	PCM16XS2	DVA16XP282	XLT28SS				AC164021	AC164307		✓*		
PIC16F77	40P, 40JW	PCM16XS2	DVA16XP401					AC164012	AC164301	✓	✓*		DM163022
PIC16F77	44L	PCM16XS2	DVA16XL441					AC164013	AC164309		✓*		
PIC16F77	44ML	PCM16XS2	DVA16XL441	XLT44QFN2				AC164012 +AC164034	AC164322	AC164034	✓*		
PIC16F77	44PT	PCM16XS2	DVA16PQ441	XLT44PT or XLT44PT3				AC164020	AC164305		✓*		
PIC16F83	18P	PCM16XH1	DVA16XP180					AC164010	AC164301	✓			DM163001
PIC16F83	18SO	PCM16XH1	DVA16XP180	XLT18SO				AC164010	AC164302				
PIC16F84	18P	PCM16XH1	DVA16XP180					AC164010	AC164301	✓			DM163001
PIC16F84	18SO	PCM16XH1	DVA16XP180	XLT18SO				AC164010	AC164302				
PIC16F84A	18P	PCM16XH1	DVA16XP180					AC164010	AC164301	✓			DM163001
PIC16F84A	18SO	PCM16XH1	DVA16XP180	XLT18SO				AC164010	AC164302				
PIC16F84A	20SS	PCM16XH1	DVA16XP180	XLT20SS				AC164018	AC164307				
PIC16F87	18P	PCM16YG0	DVA16XP186					AC164010	AC164301	✓	✓		DM163014
PIC16F87	18SO	PCM16YG0	DVA16XP186	XLT18SO				AC164010	AC164302		✓		
PIC16F87	20SS	PCM16YG0	DVA16XP186	XLT20SS				AC164018	AC164307		✓		
PIC16F87	28ML	PCM16YG0	DVA16XP186	XLT28QFN3				AC164010 +AC164033	AC164322	AC164033	✓		
PIC16F88	18P	PCM16YG0	DVA16XP186					AC164010	AC164301	✓	✓		DM163014
PIC16F88	18SO	PCM16YG0	DVA16XP186	XLT18SO				AC164010	AC164302		✓		
PIC16F88	20SS	PCM16YG0	DVA16XP186	XLT20SS				AC164018	AC164307		✓		
PIC16F88	28ML	PCM16YG0	DVA16XP186	XLT28QFN3				AC164010 +AC164033	AC164322	AC164033	✓		

NOTE: See complete list of notes on page 107.

MPLAB® ICE 2000 and MPLAB® ICE 4000 Emulator Systems, PRO MATE® II Programmer Socket Modules, MPLAB® In-Circuit Debugger, Software Tools, Programmers and Demonstration Boards (continued)

		MPLAB® ICE 2000 System (1)			MPLAB® ICE 4000 System (2)								
Part Number	Lead Count/ Pkg Type	Processor Module	Device Adapters	Transition Socket	Processor Module	Device Adapters	Transition Socket	PRO MATE® II Socket Module (3,4)	MPLAB® PM3 Socket Module (8)	PICSTART® Plus (5)	MPLAB® ICD 2 (6)	MPLAB® CXX Compiler	Demonstration Boards or Evaluation Kits
PICmicro® Microcontroller Development Tools (continued)													
PIC16F505	14P, 14JW	PCM16XA0	DVA16XP140					AC124001	AC164301	✓	AC162059		DM163014, DV164101, DV164120, DM163029
PIC16F505	14SL	PCM16XA0	DVA16XP140	XLT14SO				AC164026	AC164302		AC162059 +XLT14SO		
PIC16F505	14ST	PCM16XA0	DVA16XP140						AC164306				
PIC16F506	14P							AC124001*	AC164301*		AC162070**		DV164101*, DV164120, DM163029
PIC16F506	14SO							AC164026*	AC164302*				
PIC16F506	14ST								AC164306*				
PIC16F506	16ML								AC164324**				
PIC16F627	18P, 18JW	PCM16XP0	DVA16XP183					AC164010	AC164301	✓			DM163001
PIC16F627	18SO	PCM16XP0	DVA16XP183	XLT18SO				AC164010	AC164302				
PIC16F627	20SS	PCM16XP0	DVA16XP183	XLT20SS				AC164018	AC164307				
PIC16F627A	18P	PCM16YF0	DVA16XP186					AC164010	AC164301	✓	AC162053		DM163014
PIC16F627A	18SO	PCM16YF0	DVA16XP186	XLT18SO				AC164010	AC164302		AC162053 +XLT18SO		
PIC16F627A	20SS	PCM16YF0	DVA16XP186	XLT20SS				AC164018	AC164307		AC162053 +XLT20SS		
PIC16F627A	28ML	PCM16YF0	DVA16XP186	XLT28QFN3				AC164010 +AC164033	AC164322	AC164033	AC162053 +XLT28QFN3		
PIC16F628	18P, 18JW	PCM16XP0	DVA16XP183					AC164010	AC164301	✓			DM163001
PIC16F628	18SO	PCM16XP0	DVA16XP183	XLT18SO				AC164010	AC164302				
PIC16F628	20SS	PCM16XP0	DVA16XP183	XLT20SS				AC164018	AC164307				
PIC16F628A	18P	PCM16YF0	DVA16XP186					AC164010	AC164301	✓	AC162053		DM163014
PIC16F628A	18SO	PCM16YF0	DVA16XP186	XLT18SO				AC164010	AC164302		AC162053 +XLT18SO		
PIC16F628A	20SS	PCM16YF0	DVA16XP186	XLT20SS				AC164018	AC164307		AC162053 +XLT20SS		
PIC16F628A	28ML	PCM16YF0	DVA16XP186	XLT28QFN3				AC164010 +AC164033	AC164322	AC164033	AC162053 +XLT28QFN3		

NOTE: See complete list of notes on page 107.

**Development
Systems Products**

MPLAB® ICE 2000 and MPLAB® ICE 4000 Emulator Systems, PRO MATE® II Programmer Socket Modules, MPLAB® In-Circuit Debugger, Software Tools, Programmers and Demonstration Boards (continued)

		MPLAB® ICE 2000 System (1)			MPLAB® ICE 4000 System (2)								
Part Number	Lead Count/ Pkg Type	Processor Module	Device Adapters	Transition Socket	Processor Module	Device Adapters	Transition Socket	PRO MATE® II Socket Module (3,4)	MPLAB® PM3 Socket Module (8)	PICSTART® Plus (5)	MPLAB® ICD 2 (6)	MPLAB® CXX Compiler	Demonstration Boards or Evaluation Kits
PICmicro® Microcontroller Development Tools (continued)													
PIC16F630	14P	PCM16YD0	DVA16XP141					AC124001	AC164301	✓	AC162052		DM163014, DV164101, DV164120, DM163029
PIC16F630	14SL	PCM16YD0	DVA16XP141	XLT14SO				AC164026	AC164302		AC162052 +XLT14SO		
PIC16F630	14ST	PCM16YD0	DVA16XP141	XLT14SS				AC164026	AC164306		AC162052 +XLT14SS		
PIC16F636	14P	PCM16YM0	DVA1004**	ACICE0207				AC124001	AC164301	✓	AC162057		DV164120, DM163029
PIC16F636	14SL	PCM16YM0	DVA1004**	XLT14SO				AC164026	AC164302		AC162057 +XLT14SO		
PIC16F636	14ST	PCM16YM0	DVA1004**	XLT14SS				AC164026	AC164306		AC162057 +XLT14SS		
PIC16F639	20P	PCM16YM0*	DVA1004**	ACICE0203				AC164039	AC164301	✓*	AC162066**		DV164101*, DM163014, DM163029
PIC16F639	20SO	PCM16YM0*	DVA1004**	XLT20SO1				AC164039	AC164302		AC162066** +XLT20SO1		
PIC16F639	20SS	PCM16YM0*	DVA1004**	XLT20SS1					AC164307		AC162066** +XLT20SS1		
PIC16F648A	18P	PCM16YF0	DVA16XP186					AC164010	AC164301	✓	AC162053		DM163014
PIC16F648A	18SO	PCM16YF0	DVA16XP186	XLT18SO				AC164010	AC164302		AC162053 +XLT18SO		
PIC16F648A	20SS	PCM16YF0	DVA16XP186	XLT20SS				AC164018	AC164307		AC162053 +XLT20SS		
PIC16F648A	28ML	PCM16YF0	DVA16XP186	XLT28QFN3				AC164010 +AC164033	AC164322	AC164033	AC162053 +XLT28QFN3		
PIC16F676	14P	PCM16YD0	DVA16XP141					AC124001	AC164301	✓	AC162052		DM163014, DV164101, DV164120, DM163029
PIC16F676	14SL	PCM16YD0	DVA16XP141	XLT14SO				AC164026	AC164302		AC162052 +XLT14SO		
PIC16F676	14ST	PCM16YD0	DVA16XP141	XLT14SS				AC164026	AC164306		AC162052 +XLT14SS		

NOTE: See complete list of notes on page 107.

MPLAB® ICE 2000 and MPLAB® ICE 4000 Emulator Systems, PRO MATE® II Programmer Socket Modules, MPLAB® In-Circuit Debugger, Software Tools, Programmers and Demonstration Boards (continued)

		MPLAB® ICE 2000 System (1)			MPLAB® ICE 4000 System (2)								
Part Number	Lead Count/ Pkg Type	Processor Module	Device Adapters	Transition Socket	Processor Module	Device Adapters	Transition Socket	PRO MATE® II Socket Module (3,4)	MPLAB® PM3 Socket Module (8)	PICSTART® Plus (5)	MPLAB® ICD 2 (6)	MPLAB® CXX Compiler	Demonstration Boards or Evaluation Kits
PICmicro® Microcontroller Development Tools (continued)													
PIC16F684	14P	PCM16YK0	DVA1004**	ACICE0207				AC124001	AC164301	✓	AC162055		DV164101, DV164120, DM163029
PIC16F684	14SL	PCM16YK0	DVA1004**	XLT14SO				AC164026	AC164302		AC162055 +XLT14SO		
PIC16F684	14ST	PCM16YK0	DVA1004**	XLT14SS				AC164026	AC164306		AC162055 +XLT14SS		
PIC16F685	20P	PCM16YQ0**	DVA1004**	ACICE0203				AC164039*	AC164301*	✓*	AC162061**		DV164120, DM163029
PIC16F685	20SO	PCM16YQ0**	DVA1004**	XLT20SO1				AC164039*	AC164302*		AC162061** +XLT20SO1		
PIC16F685	20SS	PCM16YQ0**	DVA1004**	XLT20SS1					AC164307*		AC162061** +XLT20SS1		
PIC16F687	20P	PCM16YQ0**	DVA1004**	ACICE0203				AC164039*	AC164301*	✓*	AC162061**		DV164120, DM163029
PIC16F687	20SO	PCM16YQ0**	DVA1004**	XLT20SO1				AC164039*	AC164302*		AC162061** +XLT20SO1		
PIC16F687	20SS	PCM16YQ0**	DVA1004**	XLT20SS1					AC164307*		AC162061** +XLT20SS1		
PIC16F688	14P	PCM16YL0	DVA1004**	ACICE0207				AC124001	AC164301	✓	AC162056		DV164101, DV164120, DM163029
PIC16F688	14SL	PCM16YL0	DVA1004**	XLT14SO				AC164026	AC164302		AC162056 +XLT14SO		
PIC16F688	14ST	PCM16YL0	DVA1004**	XLT14SS				AC164026	AC164306		AC162056 +XLT14SS		
PIC16F689	20P	PCM16YQ0**	DVA1004**	ACICE0203				AC164039*	AC164301*		AC162061**		DV164120, DM163029
PIC16F689	20SO	PCM16YQ0**	DVA1004**	XLT20SO1				AC164039*	AC164302*		AC162061** +XLT20SO1		
PIC16F689	20SS	PCM16YQ0*	DVA1004*	XLT20SS1					AC164307*		AC162061** +XLT20SS1		

NOTE: See complete list of notes on page 107.

**Development
Systems Products**

MPLAB® ICE 2000 and MPLAB® ICE 4000 Emulator Systems, PRO MATE® II Programmer Socket Modules, MPLAB® In-Circuit Debugger, Software Tools, Programmers and Demonstration Boards (continued)

		MPLAB® ICE 2000 System (1)			MPLAB® ICE 4000 System (2)								
Part Number	Lead Count/ Pkg Type	Processor Module	Device Adapters	Transition Socket	Processor Module	Device Adapters	Transition Socket	PRO MATE® II Socket Module (3,4)	MPLAB® PM3 Socket Module (8)	PICSTART® Plus (5)	MPLAB® ICD 2 (6)	MPLAB® CXX Compiler	Demonstration Boards or Evaluation Kits
PICmicro® Microcontroller Development Tools (continued)													
PIC16F690	20P	PCM16YQ0**	DVA1004**	ACICE0203				AC164039*	AC164301*		AC162061**		DV164120, DM163029
PIC16F690	20SO	PCM16YQ0**	DVA1004**	XLT20SO1				AC164039*	AC164302*		AC162061** +XLT20SO1		
PIC16F690	20SS	PCM16YQ0**	DVA1004**	XLT20SS1					AC164307*		AC162061** +XLT20SS1		
PIC16F716	18P	PCM16YJ0	DVA16XP187					AC164010	AC164301	✓	AC162054		DM163001
PIC16F716	18SO	PCM16YJ0	DVA16XP187	XLT18SO				AC164010	AC164302		AC162054 +XLT18SO		
PIC16F716	20SS	PCM16YJ0	DVA16XP187	XLT20SS				AC164018	AC164307		AC162054 +XLT20SS		
PIC16F737	28SP	PCM16YH0	DVA18XP280					AC164012	AC164301	✓	✓		
PIC16F737	28SO	PCM16YH0	DVA18XP280	XLT28SO				AC164017	AC164302		✓		
PIC16F737	28SS	PCM16YH0	DVA18XP280	XLT28SS				AC164021	AC164307		✓		
PIC16F737	28ML	PCM16YH0	DVA18XP280	XLT28QFN4				AC164012 +AC164031	AC164322	AC164031	✓		
PIC16F747	40P	PCM16YH0	DVA18XP400					AC164012	AC164301	✓	✓		
PIC16F747	44PT	PCM16YH0	DVA18PQ440	XLT44PT or XLT44PT3				AC164020	AC164305		✓		
PIC16F747	44ML	PCM16YH0	DVA18XP400	XLT44QFN2				AC164012 +AC164034	AC164322	AC164034	✓		
PIC16F767	28P	PCM16YH0	DVA18XP280					AC164012	AC164301	✓	✓		
PIC16F767	28SO	PCM16YH0	DVA18XP280	XLT28SO				AC164017	AC164302		✓		
PIC16F767	28SS	PCM16YH0	DVA18XP280	XLT28SS				AC164021	AC164307		✓		
PIC16F767	28ML	PCM16YH0	DVA18XP280	XLT28QFN4				AC164012 +AC164031	AC164322	AC164031	✓		
PIC16F777	40P	PCM16YH0	DVA18XP400					AC164012	AC164301	✓	✓		
PIC16F777	44PT	PCM16YH0	DVA18PQ440	XLT44PT or XLT44PT3				AC164020	AC164305		✓		
PIC16F777	44ML	PCM16YH0	DVA18XP400	XLT44QFN2				AC164012 +AC164034	AC164322	AC164034	✓		
PIC16F785	20P	PCM16YN0**	DVA1004**	ACICE0203				AC164039	AC164301	✓*	AC162060**		DV164120, DM163029
PIC16F785	20SO	PCM16YN0**	DVA1004**	XLT20SO1				AC164039	AC164302		AC162060** +XLT20SO1		
PIC16F785	20SS	PCM16YN0**	DVA1004**	XLT20SS1					AC164307		AC162060** +XLT20SS1		

NOTE: See complete list of notes on page 107.

MPLAB® ICE 2000 and MPLAB® ICE 4000 Emulator Systems, PRO MATE® II Programmer Socket Modules, MPLAB® In-Circuit Debugger, Software Tools, Programmers and Demonstration Boards (continued)

		MPLAB® ICE 2000 System (1)			MPLAB® ICE 4000 System (2)								
Part Number	Lead Count/ Pkg Type	Processor Module	Device Adapters	Transition Socket	Processor Module	Device Adapters	Transition Socket	PRO MATE® II Socket Module (3,4)	MPLAB® PM3 Socket Module (8)	PICSTART® Plus (5)	MPLAB® ICD 2 (6)	MPLAB® CXX Compiler	Demonstration Boards or Evaluation Kits
PICmicro® Microcontroller Development Tools (continued)													
PIC16F818	18P	PCM16YE0	DVA16XP186					AC164010	AC164301	✓	✓		DM163014
PIC16F818	18SO	PCM16YE0	DVA16XP186	XLT18SO				AC164010	AC164302		✓		
PIC16F818	20SS	PCM16YE0	DVA16XP186	XLT20SS				AC164018	AC164307		✓		
PIC16F818	28ML	PCM16YE0	DVA16XP186	XLT28QFN3				AC164010 +AC164033	AC164322	AC164033	✓		
PIC16F819	18P	PCM16YE0	DVA16XP186					AC164010	AC164301	✓	✓		DM163014
PIC16F819	18SO	PCM16YE0	DVA16XP186	XLT18SO				AC164010	AC164302		✓		
PIC16F819	20SS	PCM16YE0	DVA16XP186	XLT20SS				AC164018	AC164307		✓		
PIC16F819	28ML	PCM16YE0	DVA16XP186	XLT28QFN3				AC164010 +AC164033	AC164322	AC164033	✓		
PIC16F870	28SP, 28JW	PCM16XR1	DVA16XP282					AC164012	AC164301	✓	✓		DM163022
PIC16F870	28SO	PCM16XR1	DVA16XP282	XLT28SO				AC164017	AC164302		✓		
PIC16F870	28SS	PCM16XR1	DVA16XP282	XLT28SS				AC164021	AC164307		✓		
PIC16F871	40P	PCM16XR1	DVA16XP401					AC164012	AC164301	✓	✓		DM163022
PIC16F871	44L	PCM16XR1	DVA16XL441					AC164013	AC164309		✓		
PIC16F871	44PT	PCM16XR1	DVA16PQ441	XLT44PT or XLT44PT3				AC164020	AC164305		✓		
PIC16F872	28SP	PCM16XK1	DVA16XP282					AC164012	AC164301	✓	✓		DM163022
PIC16F872	28SO	PCM16XK1	DVA16XP282	XLT28SO				AC164017	AC164302		✓		
PIC16F872	28SS	PCM16XK1	DVA16XP282	XLT28SS				AC164021	AC164307		✓		
PIC16F873	28SP	PCM16XK1	DVA16XP282					AC164012	AC164301	✓	✓		DM163022
PIC16F873	28SO	PCM16XK1	DVA16XP282	XLT28SO				AC164017	AC164302		✓		
PIC16F873A	28SP	PCM16XV0	DVA16XP282					AC164012	AC164301	✓	✓		DM163022
PIC16F873A	28SO	PCM16XV0	DVA16XP282	XLT28SO				AC164017	AC164302		✓		
PIC16F873A	28SS	PCM16XV0	DVA16XP282	XLT28SS				AC164021	AC164307		✓		
PIC16F873A	28ML	PCM16XV0	DVA16XP282	XLT28QFN4				AC164012 +AC164031	AC164322	AC164031	✓		
PIC16F874	40P	PCM16XK1	DVA16XP401					AC164012	AC164301	✓	✓		DM163022
PIC16F874	44L	PCM16XK1	DVA16XL441					AC164013	AC164309		✓		
PIC16F874	44PQ	PCM16XK1	DVA16PQ441	XLT44PT or XLT44PT3				AC164014	AC164311		✓		
PIC16F874	44PT	PCM16XK1	DVA16PQ441	XLT44PT or XLT44PT3				AC164020	AC164305		✓		

NOTE: See complete list of notes on page 107.

**Development
Systems Products**

MPLAB® ICE 2000 and MPLAB® ICE 4000 Emulator Systems, PRO MATE® II Programmer Socket Modules, MPLAB® In-Circuit Debugger, Software Tools, Programmers and Demonstration Boards (continued)

		MPLAB® ICE 2000 System (1)			MPLAB® ICE 4000 System (2)								
Part Number	Lead Count/ Pkg Type	Processor Module	Device Adapters	Transition Socket	Processor Module	Device Adapters	Transition Socket	PRO MATE® II Socket Module (3,4)	MPLAB® PM3 Socket Module (8)	PICSTART® Plus (5)	MPLAB® ICD 2 (6)	MPLAB® CXX Compiler	Demonstration Boards or Evaluation Kits
PICmicro® Microcontroller Development Tools (continued)													
PIC16F874A	40P	PCM16XV0	DVA16XP401					AC164012	AC164301	✓	✓		DM163022
PIC16F874A	44L	PCM16XV0	DVA16XL441					AC164013	AC164309		✓		
PIC16F874A	44PT	PCM16XV0	DVA16PQ441	XLT44PT or XLT44PT3				AC164020	AC164305		✓		
PIC16F874A	44ML	PCM16XV0	DVA16XP401	XLT44QFN2				AC164012 +AC164034	AC164322	AC164034	✓		
PIC16F876	28SP	PCM16XK1	DVA16XP282					AC164012	AC164301	✓	✓		DM163022
PIC16F876	28SO	PCM16XK1	DVA16XP282	XLT28SO				AC164017	AC164302		✓		
PIC16F876A	28SP	PCM16XV0	DVA16XP282					AC164012	AC164301	✓	✓		DM163022
PIC16F876A	28SO	PCM16XV0	DVA16XP282	XLT28SO				AC164017	AC164302		✓		
PIC16F876A	28SS	PCM16XV0	DVA16XP282	XLT28SS				AC164021	AC164307		✓		
PIC16F876A	28ML	PCM16XV0	DVA16XP282	XLT28QFN4				AC164012 +AC164031	AC164322	AC164031	✓		
PIC16F877	40P	PCM16XK1	DVA16XP401					AC164012	AC164301	✓	✓		DM163022
PIC16F877	44L	PCM16XK1	DVA16XL441					AC164013	AC164309		✓		
PIC16F877	44PQ	PCM16XK1	DVA16PQ441	XLT44PT or XLT44PT3				AC164014	AC164311		✓		
PIC16F877	44PT	PCM16XK1	DVA16PQ441	XLT44PT or XLT44PT3				AC164020	AC164305		✓		
PIC16F877A	40P	PCM16XV0	DVA16XP401					AC164012	AC164301	✓	✓		DM163022
PIC16F877A	44L	PCM16XV0	DVA16XL441					AC164013	AC164309		✓		
PIC16F877A	44PT	PCM16XV0	DVA16PQ441	XLT44PT or XLT44PT3				AC164020	AC164305		✓		
PIC16F877A	44ML	PCM16XV0	DVA16XP401	XLT44QFN2				AC164012 +AC164034	AC164322	AC164034	✓		
PIC16F913	28P	PCM16YP0**	DVA18XP280					AC164012	AC164301	✓*	✓		DV164120
PIC16F913	28SO	PCM16YP0**	DVA18XP280	XLT28SO				AC164017	AC164302		✓		
PIC16F913	28SS	PCM16YP0**	DVA18XP280	XLT28SS				AC164021	AC164307		✓		
PIC16F913	28ML	PCM16YP0**	DVA18XP280	XLT28QFN4				AC164012 +AC164031	AC164322	AC164031*	✓		

NOTE: See complete list of notes on page 107.

MPLAB® ICE 2000 and MPLAB® ICE 4000 Emulator Systems, PRO MATE® II Programmer Socket Modules, MPLAB® In-Circuit Debugger, Software Tools, Programmers and Demonstration Boards (continued)

		MPLAB® ICE 2000 System (1)			MPLAB® ICE 4000 System (2)								
Part Number	Lead Count/ Pkg Type	Processor Module	Device Adapters	Transition Socket	Processor Module	Device Adapters	Transition Socket	PRO MATE® II Socket Module (3,4)	MPLAB® PM3 Socket Module (8)	PICSTART® Plus (5)	MPLAB® ICD 2 (6)	MPLAB® CXX Compiler	Demonstration Boards or Evaluation Kits
PICmicro® Microcontroller Development Tools (continued)													
PIC16F914	40P	PCM16YP0**	DVA18XP400					AC164012	AC164301	✓*	✓		DV164120, DM163029
PIC16F914	44PT	PCM16YP0**	DVA18PQ440	XLT44PT or XLT44PT3				AC164020	AC164305		✓		
PIC16F914	44ML	PCM16YP0**	DVA18XP400	XLT44QFN2				AC164012 +AC164034	AC164322	AC164034*	✓		
PIC16F916	28P	PCM16YP0**	DVA18XP280					AC164012	AC164301	✓*	✓		DV164120
PIC16F916	28SO	PCM16YP0**	DVA18XP280	XLT28SO				AC164017	AC164302		✓		
PIC16F916	28SS	PCM16YP0**	DVA18XP280	XLT28SS				AC164021	AC164307		✓		
PIC16F916	28ML	PCM16YP0**	DVA18XP280	XLT28QFN4				AC164012 +AC164031	AC164322	AC164031*	✓		
PIC16F917	40P	PCM16YP0**	DVA18XP400					AC164012	AC164301	✓*	✓		DV164120, DM163029
PIC16F917	44PT	PCM16YP0**	DVA18PQ440	XLT44PT or XLT44PT3				AC164020	AC164305		✓		
PIC16F917	44ML	PCM16YP0**	DVA18XP400	XLT44QFN2				AC164012 +AC164034	AC164322	AC164034*	✓		
PIC16F946	64PT	PCM16YP0**	DVA1005**	XLT64PT5				TBD	AC164303*		✓*		
PIC16HV540	18P, 18JW							AC164001	AC164301	✓			
PIC16HV540	18SO							AC164002	AC164302				
PIC16HV540	20SS							AC164015	AC164307				
PIC17C42A	40P, 40JW	PCM17XA0	DVA17XP401					AC174001	AC164301	✓			DM163001
PIC17C42A	44L	PCM17XA0	DVA17XL441					AC174002	AC164317				
PIC17C42A	44PQ	PCM17XA0	DVA17PQ441	XLT44PT or XLT44PT3				AC174004	AC164316				
PIC17C42A	44PT	PCM17XA0	DVA17PQ441	XLT44PT or XLT44PT3				AC174005	AC164315				
PIC17C43	40P, 40JW	PCM17XA0	DVA17XP401					AC174001	AC164301	✓			DM163001
PIC17C43	44L	PCM17XA0	DVA17XL441					AC174002	AC164317				
PIC17C43	44PQ	PCM17XA0	DVA17PQ441	XLT44PT or XLT44PT3				AC174004	AC164316				
PIC17C43	44PT	PCM17XA0	DVA17PQ441	XLT44PT or XLT44PT3				AC174005	AC164315				

NOTE: See complete list of notes on page 107.

**Development
Systems Products**

MPLAB® ICE 2000 and MPLAB® ICE 4000 Emulator Systems, PRO MATE® II Programmer Socket Modules, MPLAB® In-Circuit Debugger, Software Tools, Programmers and Demonstration Boards (continued)

		MPLAB® ICE 2000 System (1)			MPLAB® ICE 4000 System (2)								
Part Number	Lead Count/ Pkg Type	Processor Module	Device Adapters	Transition Socket	Processor Module	Device Adapters	Transition Socket	PRO MATE® II Socket Module (3,4)	MPLAB® PM3 Socket Module (8)	PICSTART® Plus (5)	MPLAB® ICD 2 (6)	MPLAB® CXX Compiler	Demonstration Boards or Evaluation Kits
PICmicro® Microcontroller Development Tools (continued)													
PIC17C44	40P, 40JW	PCM17XA0	DVA17XP401					AC174001	AC164301	✓			DM163001
PIC17C44	44L	PCM17XA0	DVA17XL441					AC174002	AC164317				
PIC17C44	44PQ	PCM17XA0	DVA17PQ441	XLT44PT or XLT44PT3				AC174004	AC164316				
PIC17C44	44PT	PCM17XA0	DVA17PQ441	XLT44PT or XLT44PT3				AC174005	AC164315				
PIC17C752	68L	PCM17XA0	DVA17XL681					AC174007	AC164308	AC164024			DM173001
PIC17C752	64PT	PCM17XA0	DVA17PQ641	XLT64PT2 or XLT64PT5				AC174008	AC164319				
PIC17C756/756A	68L, 68CL	PCM17XA0	DVA17XL681					AC174007	AC164308	AC164024			DM173001
PIC17C756/756A	64PT	PCM17XA0	DVA17PQ641	XLT64PT2 or XLT64PT5				AC174008	AC164319				
PIC17C762	84L	PCM17XA0	DVA17XL841					AC174012	AC164318	AC164027			DM173001
PIC17C762	80PT	PCM17XA0	DVA17PQ801	XLT80PT or XLT80PT3				AC174011	AC164320				
PIC17C766	84L, 84CL	PCM17XA0	DVA17XL841					AC174012	AC164318	AC164027			DM173001
PIC17C766	80PT	PCM17XA0	DVA17PQ801	XLT80PT or XLT80PT3				AC174011	AC164320				
PIC18C242	28SP, 28JW	PCM18XA0	DVA16XP282					AC164012	AC164301	✓		SW006011	DM163022
PIC18C242	28SO	PCM18XA0	DVA16XP282	XLT28SO				AC164017	AC164302			SW006011	
PIC18C252	28SP	PCM18XA0	DVA16XP282					AC164012	AC164301	✓		SW006011	DM163022
PIC18C252	28JW	PCM18XA0	DVA16XP282	XLT28XP				AC164012	AC164301			SW006011	DM163022
PIC18C252	28SO	PCM18XA0	DVA16XP282	XLT28SO				AC164017	AC164302			SW006011	
PIC18C442	40P, 40JW	PCM18XA0	DVA16XP401					AC164012	AC164301	✓		SW006011	DM163022
PIC18C442	44L	PCM18XA0	DVA16XL441					AC164013	AC164309			SW006011	
PIC18C442	44PT	PCM18XA0	DVA16PQ441	XLT44PT or XLT44PT3				AC164020	AC164305			SW006011	
PIC18C452	40P, 40JW	PCM18XA0	DVA16XP401					AC164012	AC164301	✓		SW006011	DM163022
PIC18C452	44L	PCM18XA0	DVA16XL441					AC164013	AC164309			SW006011	
PIC18C452	44PT	PCM18XA0	DVA16PQ441	XLT44PT or XLT44PT3				AC164020	AC164305			SW006011	
PIC18C601	68L				PMF18WB1	DAF18-1	XLT68L1	AC174007	AC164308		✓	SW006011	DM163006
PIC18C601	64PT				PMF18WB1	DAF18-1	XLT64PT2 or XLT64PT5	AC174008	AC164303		✓	SW006011	

NOTE: See complete list of notes on page 107.

MPLAB® ICE 2000 and MPLAB® ICE 4000 Emulator Systems, PRO MATE® II Programmer Socket Modules, MPLAB® In-Circuit Debugger, Software Tools, Programmers and Demonstration Boards (continued)

		MPLAB® ICE 2000 System (1)			MPLAB® ICE 4000 System (2)								
Part Number	Lead Count/ Pkg Type	Processor Module	Device Adapters	Transition Socket	Processor Module	Device Adapters	Transition Socket	PRO MATE® II Socket Module (3,4)	MPLAB® PM3 Socket Module (8)	PICSTART® Plus (5)	MPLAB® ICD 2 (6)	MPLAB® CXX Compiler	Demonstration Boards or Evaluation Kits
PICmicro® Microcontroller Development Tools (continued)													
PIC18C658	68L	PCM18XB0	DVA18XL680					AC174007	AC164308	✓ (7)		SW006011	DM163007
PIC18C658	64PT	PCM18XB0	DVA18PQ640	XLT64PT2 or XLT64PT5				AC174008	AC164303			SW006011	
PIC18C801	80PT				PMF18WB1	DAF18-1	XLT80PT or XLT80PT3	AC174011	AC164304		✓	SW006011	
PIC18C801	84L				PMF18WB1	DAF18-1	XLT84L1	AC174012	AC164310		✓	SW006011	DM163006
PIC18C858	84L	PCM18XB0	DVA18XL840					AC174012	AC164310	✓ (7)		SW006011	DM163007
PIC18C858	80PT	PCM18XB0	DVA18PQ800	XLT80PT or XLT80PT3				AC174011	AC164304			SW006011	
PIC18F242	28SP	PCM18XH2	DVA16XP282 or DVA18XP280		PMF18WC1	DAF18-2	ACICE0204	AC164012	AC164301	✓	✓	SW006011	DM163022
PIC18F242	28SO	PCM18XH2	DVA16XP282 or DVA18XP280	XLT28SO	PMF18WC1	DAF18-2	XLT28SO	AC164017	AC164302		✓	SW006011	
PIC18F248	28SP	PCM18XD1	DVA16XP282					AC164012	AC164301	✓	✓	SW006011	DM163011
PIC18F248	28SO	PCM18XD1	DVA16XP282	XLT28SO				AC164017	AC164302		✓	SW006011	
PIC18F252	28SP	PCM18XH2	DVA16XP282 or DVA18XP280		PMF18WC1	DAF18-2	ACICE0204	AC164012	AC164301	✓	✓	SW006011	DM163022
PIC18F252	28SO	PCM18XH2	DVA16XP282 or DVA18XP280	XLT28SO	PMF18WC1	DAF18-2	XLT28SO	AC164017	AC164302		✓	SW006011	
PIC18F258	28SP	PCM18XD1	DVA16XP282					AC164012	AC164301	✓	✓	SW006011	DM163011
PIC18F258	28SO	PCM18XD1	DVA16XP282	XLT28SO				AC164017	AC164302		✓	SW006011	
PIC18F442	40P	PCM18XH2	DVA16XP401 or DVA18XP400		PMF18WC1	DAF18-2	ACICE0206	AC164012	AC164301	✓	✓	SW006011	DM163022
PIC18F442	44L	PCM18XH2	DVA16XL441		PMF18WC1	DAF18-3	XLT44L2	AC164013	AC164309		✓	SW006011	
PIC18F442	44PT	PCM18XH2	DVA16PQ441 or DVA18PQ440	XLT44PT or XLT44PT3	PMF18WC1	DAF18-3	XLT44PT or XLT44PT3	AC164020	AC164305		✓	SW006011	
PIC18F448	40P	PCM18XD1	DVA16XP401					AC164012	AC164301	✓	✓	SW006011	DM163011
PIC18F448	44L	PCM18XD1	DVA16XL441					AC164013	AC164309		✓	SW006011	
PIC18F448	44PT	PCM18XD1	DVA16PQ441	XLT44PT or XLT44PT3				AC164020	AC164305		✓	SW006011	
PIC18F452	40P	PCM18XH2	DVA16XP401		PMF18WC1	DAF18-2	ACICE0206	AC164012	AC164301	✓	✓	SW006011	DM163022
PIC18F452	44L	PCM18XH2	DVA16XL441		PMF18WC1	DAF18-3	XLT44L2	AC164013	AC164309		✓	SW006011	
PIC18F452	44PT	PCM18XH2	DVA16PQ441	XLT44PT or XLT44PT3	PMF18WC1	DAF18-3	XLT44PT or XLT44PT3	AC164020	AC164305		✓	SW006011	

NOTE: See complete list of notes on page 107.

**Development
Systems Products**

MPLAB® ICE 2000 and MPLAB® ICE 4000 Emulator Systems, PRO MATE® II Programmer Socket Modules, MPLAB® In-Circuit Debugger, Software Tools, Programmers and Demonstration Boards (continued)

		MPLAB® ICE 2000 System (1)			MPLAB® ICE 4000 System (2)								
Part Number	Lead Count/ Pkg Type	Processor Module	Device Adapters	Transition Socket	Processor Module	Device Adapters	Transition Socket	PRO MATE® II Socket Module (3,4)	MPLAB® PM3 Socket Module (8)	PICSTART® Plus (5)	MPLAB® ICD 2 (6)	MPLAB® CXX Compiler	Demonstration Boards or Evaluation Kits
PICmicro® Microcontroller Development Tools (continued)													
PIC18F458	40P	PCM18XD1	DVA16XP401					AC164012	AC164301	✓	✓	SW006011	DM163011
PIC18F458	44L	PCM18XD1	DVA16XL441					AC164013	AC164309		✓	SW006011	
PIC18F458	44PT	PCM18XD1	DVA16PQ441	XLT44PT or XLT44PT3				AC164020	AC164305		✓	SW006011	
PIC18F1220	18P	PCM18XJ0	DVA18XP180		PMF18WD0	DAF18-2	ACICE0202	AC164010	AC164301	✓*	✓	SW006011	DM163014
PIC18F1220	18SO	PCM18XJ0	DVA18XP180	XLT18SO	PMF18WD0	DAF18-2	XLT18SO	AC164010	AC164302		✓	SW006011	
PIC18F1220	20SS	PCM18XJ0	DVA18XP180	XLT20SS	PMF18WD0	DAF18-2	XLT20SS	AC164018	AC164307		✓	SW006011	
PIC18F1220	28ML	PCM18XJ0	DVA18XP180	XLT28QFN3	PMF18WD0	DAF18-2	XLT28QFN3	AC164010 +AC164033	AC164322	AC164033*	✓	SW006011	
PIC18F1230	18P							TBD	AC164301*		✓*	SW006011*	
PIC18F1230	18SO							TBD	AC164302*		✓*	SW006011*	
PIC18F1230	20SS							TBD	AC164307*		✓*	SW006011*	
PIC18F1230	28ML							TBD	AC164322*		✓*	SW006011*	
PIC18F1231	18P							TBD	AC164301*		✓*	SW006011*	
PIC18F1231	18SO							TBD	AC164302*		✓*	SW006011*	
PIC18F1231	20SS							TBD	AC164307*		✓*	SW006011*	
PIC18F1231	28ML							TBD	AC164322*		✓*	SW006011*	
PIC18F1320	18P	PCM18XJ0	DVA18XP180		PMF18WD0	DAF18-2	ACICE0202	AC164010	AC164301	✓*	✓	SW006011	DM163014
PIC18F1320	18SO	PCM18XJ0	DVA18XP180	XLT18SO	PMF18WD0	DAF18-2	XLT18SO	AC164010	AC164302		✓	SW006011	
PIC18F1320	20SS	PCM18XJ0	DVA18XP180	XLT20SS	PMF18WD0	DAF18-2	XLT20SS	AC164018	AC164307		✓	SW006011	
PIC18F1320	28ML	PCM18XJ0	DVA18XP180	XLT28QFN3	PMF18WD0	DAF18-2	XLT28QFN3	AC164010 +AC164033	AC164322	AC164033*	✓	SW006011	
PIC18F1330	18P							TBD	AC164301*		✓*	SW006011*	
PIC18F1330	18SO							TBD	AC164302*		✓*	SW006011*	
PIC18F1330	20SS							TBD	AC164307*		✓*	SW006011*	
PIC18F1330	28ML							TBD	AC164322*		✓*	SW006011*	
PIC18F1331	18P							TBD	AC164301*		✓*	SW006011*	
PIC18F1331	18SO							TBD	AC164302*		✓*	SW006011*	
PIC18F1331	20SS							TBD	AC164307*		✓*	SW006011*	
PIC18F1331	28ML							TBD	AC164322*		✓*	SW006011*	
PIC18F2220	28SP	PCM18XH2	DVA18XP280		PMF18WC1	DAF18-2	ACICE0204	AC164012	AC164301	✓	✓	SW006011	
PIC18F2220	28SO	PCM18XH2	DVA18XP280	XLT28SO	PMF18WC1	DAF18-2	XLT28SO	AC164017	AC164302		✓	SW006011	

NOTE: See complete list of notes on page 107.

MPLAB® ICE 2000 and MPLAB® ICE 4000 Emulator Systems, PRO MATE® II Programmer Socket Modules, MPLAB® In-Circuit Debugger, Software Tools, Programmers and Demonstration Boards (continued)

		MPLAB® ICE 2000 System (1)			MPLAB® ICE 4000 System (2)								
Part Number	Lead Count/ Pkg Type	Processor Module	Device Adapters	Transition Socket	Processor Module	Device Adapters	Transition Socket	PRO MATE® II Socket Module (3,4)	MPLAB® PM3 Socket Module (8)	PICSTART® Plus (5)	MPLAB® ICD 2 (6)	MPLAB® CXX Compiler	Demonstration Boards or Evaluation Kits
PICmicro® Microcontroller Development Tools (continued)													
PIC18F2221	28SP	PCM18XN0*	DVA18XP280		PMF18WH0*	DAF18-4	ACICE0204	AC164012*	AC164301*		✓*	SW006011*	
PIC18F2221	28SO	PCM18XN0*	DVA18XP280	XLT28SO	PMF18WH0*	DAF18-4	XLT28SO	AC164017*	AC164302*		✓*	SW006011*	
PIC18F2221	28ML	PCM18XN0*	DVA18XP280	XLT28QFN4	PMF18WH0*	DAF18-4	XLT28QFN4		AC164322*		✓*	SW006011*	
PIC18F2320	28SP	PCM18XH2	DVA18XP280		PMF18WC1	DAF18-2	ACICE0204	AC164012	AC164301	✓	✓	SW006011	
PIC18F2320	28SO	PCM18XH2	DVA18XP280	XLT28SO	PMF18WC1	DAF18-2	XLT28SO	AC164017	AC164302		✓	SW006011	
PIC18F2321	28SP	PCM18XN0*	DVA18XP280		PMF18WH0*	DAF18-4	ACICE0204	AC164012*	AC164301*		✓*	SW006011*	
PIC18F2321	28SO	PCM18XN0*	DVA18XP280	XLT28SO	PMF18WH0*	DAF18-4	XLT28SO	AC164017*	AC164302*		✓*	SW006011*	
PIC18F2321	28ML	PCM18XN0*	DVA18XP280	XLT28QFN4	PMF18WH0*	DAF18-4	XLT28QFN4		AC164322*		✓*	SW006011*	
PIC18F2331	28SP	PCM18XL0	DVA18XP280		PMF18WF0	DAF18-4	ACICE0204	AC164035	AC164301	✓*	✓	SW006011	DM183011, DM183021
PIC18F2331	28SO	PCM18XL0	DVA18XP280	XLT28SO	PMF18WF0	DAF18-4	XLT28SO	AC164017	AC164302		✓	SW006011	
PIC18F2331	28MM	PCM18XL0	DVA18XP280	XLT28QFN4	PMF18WF0	DAF18-4	XLT28QFN4	AC164035 +AC164031	AC164322	AC164031*	✓	SW006011	
PIC18F2410	28SP	PCM18XN0	DVA18XP280		PMF18WH0	DAF18-4	ACICE0204	AC164012	AC164301	✓	✓	SW006011	
PIC18F2410	28SO	PCM18XN0	DVA18XP280	XLT28SO	PMF18WH0	DAF18-4	XLT28SO	AC164017	AC164302		✓	SW006011	
PIC18F2410	28ML	PCM18XN0	DVA18XP280	XLT28QFN4	PMF18WH0	DAF18-4	XLT28QFN4	AC164035 +AC164031	AC164322	AC164031	✓	SW006011	
PIC18F2420	28SP	PCM18XN0	DVA18XP280		PMF18WH0	DAF18-4	ACICE0204	AC164012	AC164301	✓	✓	SW006011	
PIC18F2420	28SO	PCM18XN0	DVA18XP280	XLT28SO	PMF18WH0	DAF18-4	XLT28SO	AC164017	AC164302		✓	SW006011	
PIC18F2420	28ML	PCM18XN0	DVA18XP280	XLT28QFN4	PMF18WH0	DAF18-4	XLT28QFN4	AC164035 +AC164031	AC164322	AC164031	✓	SW006011	
PIC18F2431	28SP	PCM18XL0	DVA18XP280		PMF18WF0	DAF18-4	ACICE0204	AC164035	AC164301	✓*	✓	SW006011	DM183011, DM183021
PIC18F2431	28SO	PCM18XL0	DVA18XP280	XLT28SO	PMF18WF0	DAF18-4	XLT28SO	AC164017	AC164302		✓	SW006011	
PIC18F2431	28MM	PCM18XL0	DVA18XP280	XLT28QFN4	PMF18WF0	DAF18-4	XLT28QFN4	AC164035 +AC164031	AC164322	AC164031*	✓	SW006011	
PIC18F2439	28P							AC164012			✓	SW006011	
PIC18F2439	28SO							AC164017			✓	SW006011	
PIC18F2455	28SP	PCM18XR0	DVA18XP280		PMF18WL0	DAF18-4	ACICE0204	AC164012	AC164301	✓	AC162063**	SW006011	DM163025
PIC18F2455	28SO	PCM18XR0	DVA18XP280	XLT28SO	PMF18WL0	DAF18-4	XLT28SO	AC164017	AC164302		AC162063** +XLT28SO	SW006011	DM163025

NOTE: See complete list of notes on page 107.

**Development
Systems Products**

MPLAB® ICE 2000 and MPLAB® ICE 4000 Emulator Systems, PRO MATE® II Programmer Socket Modules, MPLAB® In-Circuit Debugger, Software Tools, Programmers and Demonstration Boards (continued)

		MPLAB® ICE 2000 System (1)			MPLAB® ICE 4000 System (2)								
Part Number	Lead Count/ Pkg Type	Processor Module	Device Adapters	Transition Socket	Processor Module	Device Adapters	Transition Socket	PRO MATE® II Socket Module (3,4)	MPLAB® PM3 Socket Module (8)	PICSTART® Plus (5)	MPLAB® ICD 2 (6)	MPLAB® CXX Compiler	Demonstration Boards or Evaluation Kits
PICmicro® Microcontroller Development Tools (continued)													
PIC18F2480	28SP	PCM18XP0	DVA18XP280		PMF18WJ0	DAF18-4	ACICE0204	AC164012	AC164301	✓*	✓	SW006011	DM163011
PIC18F2480	28SO	PCM18XP0	DVA18XP280	XLT28SO	PMF18WJ0	DAF18-4	XLT28SO	AC164017	AC164302		✓	SW006011	
PIC18F2480	28MM	PCM18XP0	DVA18XP280	XLT28QFN4	PMF18WJ0	DAF18-4	XLT28QFN4	AC164012 +AC164031	AC164322	AC164031*	✓	SW006011	
PIC18F24J10	28SP								AC164301*		AC162067**	SW006011	
PIC18F24J10	28SO								AC164302*		AC162067** +XLT28SO	SW006011	
PIC18F24J10	28SS								AC164307*		AC162067** +XLT28SS	SW006011	
PIC18F2510	28SP	PCM18XN0	DVA18XP280		PMF18WH0	DAF18-4	ACICE0204	AC164012	AC164301	✓	✓	SW006011	DM163022
PIC18F2510	28SO	PCM18XN0	DVA18XP280	XLT28SO	PMF18WH0	DAF18-4	XLT28SO	AC164017	AC164302		✓	SW006011	
PIC18F2510	28ML	PCM18XN0	DVA18XP280	XLT28QFN4	PMF18WH0	DAF18-4	XLT28QFN4	AC164012 +AC164031	AC164322	AC164031	✓	SW006011	
PIC18F2515	28SP	PCM18XN0	DVA18XP280		PMF18WH0	DAF18-4	ACICE0204	AC164012	AC164301	✓	✓	SW006011	
PIC18F2515	28SO	PCM18XN0	DVA18CP280	XLT28SO	PMF18WH0	DAF18-4	XLT28SO	AC164017	AC164302		✓	SW006011	
PIC18F2520	28SP	PCM18XN0	DVA18XP280		PMF18WH0	DAF18-4	ACICE0204	AC164012	AC164301	✓	✓	SW006011	DM163022
PIC18F2520	28SO	PCM18XN0	DVA18XP280	XLT28SO	PMF18WH0	DAF18-4	XLT28SO	AC164017	AC164302		✓	SW006011	
PIC18F2520	28ML	PCM18XN0	DVA18XP280	XLT28QFN4	PMF18WH0	DAF18-4	XLT28QFN4	AC164012 +AC164031	AC164322	AC164031	✓	SW006011	
PIC18F2525	28SP	PCM18XN0	DVA18XP280		PMF18WH0	DAF18-4	ACICE0204	AC164012	AC164301	✓	✓	SW006011	
PIC18F2525	28SO	PCM18XN0	DVA18XP280	XLT28SO	PMF18WH0	DAF18-4	XLT28SO	AC164017	AC164302		✓	SW006011	
PIC18F2539	28P							AC164012			✓	SW006011	
PIC18F2539	28SO							AC164017			✓	SW006011	
PIC18F2550	28SP	PCM18XR0	DVA18XP280		PMF18WL0	DAF18-4	ACICE0204	AC164012	AC164301	✓*	AC162063**	SW006011	DM163025
PIC18F2550	28SO	PCM18XR0	DVA18XP280	XLT28SO	PMF18WL0	DAF18-4	XLT28SO	AC164017	AC164302		AC162063** +XLT28SO	SW006011	DM163025
PIC18F2580	28SP	PCM18XP0	DVA18XP280		PMF18WJ0	DAF18-4	ACICE0204	AC164012	AC164301	✓*	✓	SW006011	DM163011
PIC18F2580	28SO	PCM18XP0	DVA18XP280	XLT28SO	PMF18WJ0	DAF18-4	XLT28SO	AC164017	AC164302		✓	SW006011	
PIC18F2580	28MM	PCM18XP0	DVA18XP280	XLT28QFN4	PMF18WJ0	DAF18-4	XLT28QFN4	AC164012 +AC164031	AC164322	AC164031*	✓	SW006011	
PIC18F2585	28SP	PCM18XP0	DVA18XP280		PMF18WJ0	DAF18-4	ACICE0204	AC164012	AC164301	✓	✓	SW006011	DM163011
PIC18F2585	28SO	PCM18XP0	DVA18XP280	XLT28SO	PMF18WJ0	DAF18-4	XLT28SO	AC164017	AC164302		✓	SW006011	

NOTE: See complete list of notes on page 107.

MPLAB® ICE 2000 and MPLAB® ICE 4000 Emulator Systems, PRO MATE® II Programmer Socket Modules, MPLAB® In-Circuit Debugger, Software Tools, Programmers and Demonstration Boards (continued)

		MPLAB® ICE 2000 System (1)			MPLAB® ICE 4000 System (2)								
Part Number	Lead Count/ Pkg Type	Processor Module	Device Adapters	Transition Socket	Processor Module	Device Adapters	Transition Socket	PRO MATE® II Socket Module (3,4)	MPLAB® PM3 Socket Module (8)	PICSTART® Plus (5)	MPLAB® ICD 2 (6)	MPLAB® CXX Compiler	Demonstration Boards or Evaluation Kits
PICmicro® Microcontroller Development Tools (continued)													
PIC18F25J10	28SP								AC164301*		AC162067**	SW006011	
PIC18F25J10	28SO								AC164302*		AC162067** +XLT28SO	SW006011	
PIC18F25J10	28SS								AC164307*		AC162067** +XLT28SS	SW006011	
PIC18F2610	28SP	PCM18XN0	DVA18XP280		PMF18WH0	DAF18-4	ACICE0204	AC164012	AC164301	✓	✓	SW006011	
PIC18F2610	28SO	PCM18XN0	DVA18XP280	XLT28SO	PMF18WH0	DAF18-4	XLT28SO	AC164017	AC164302		✓	SW006011	
PIC18F2620	28SP	PCM18XN0	DVA18XP280		PMF18WH0	DAF18-4	ACICE0204	AC164012	AC164301	✓	✓	SW006011	
PIC18F2620	28SO	PCM18XN0	DVA18XP280	XLT28SO	PMF18WH0	DAF18-4	XLT28SO	AC164017	AC164302		✓	SW006011	
PIC18F2680	28SP	PCM18XP0	DVA18XP280		PMF18WJ0	DAF18-4	ACICE0204	AC164012	AC164301	✓	✓	SW006011	DM163011
PIC18F2680	28SO	PCM18XP0	DVA18XP280	XLT28SO	PMF18WJ0	DAF18-4	XLT28SO	AC164017	AC164302		✓	SW006011	
PIC18F4220	40P	PCM18XH2	DVA18XP400		PMF18WC1	DAF18-2	ACICE0206	AC164012	AC164301	✓	✓	SW006011	
PIC18F4220	44ML	PCM18XH2	DVA18XP400	XLT44QFN2	PMF18WC1	DAF18-2	XLT44QFN2	AC164012 +AC164034	AC164322	AC164034	✓	SW006011	
PIC18F4220	44PT	PCM18XH2	DVA18PQ440	XLT44PT or XLT44PT3	PMF18WC1	DAF18-3	XLT44PT or XLT44PT3	AC164020	AC164305		✓	SW006011	
PIC18F4221	40P	PCM18XN0*	DVA18XP400		PMF18WH0*	DAF18-4	ACICE0206	AC164012*	AC164301*		✓*	SW006011*	
PIC18F4221	44PT	PCM18XN0*	DVA18PQ440	XLT44PT or XLT44PT3	PMF18WH0*	DAF18-5	XLT44PT or XLT44PT3	AC164020*	AC164305*		✓*	SW006011*	
PIC18F4221	44ML	PCM18XN0*	DVA18XP400	XLT44QFN2	PMF18WH0*	DAF18-4	XLT44QFN2		AC164322*		✓*	SW006011*	
PIC18F4320	40P	PCM18XH2	DVA18XP400		PMF18WC1	DAF18-2	ACICE0206	AC164012	AC164301	✓	✓	SW006011	
PIC18F4320	44ML	PCM18XH2	DVA18XP400	XLT44QFN2	PMF18WC1	DAF18-2	XLT44QFN2	AC164012 +AC164034	AC164322	AC164034	✓	SW006011	
PIC18F4320	44PT	PCM18XH2	DVA18PQ440	XLT44PT or XLT44PT3	PMF18WC1	DAF18-3	XLT44PT or XLT44PT3	AC164020	AC164305		✓	SW006011	
PIC18F4321	40P	PCM18XN0*	DVA18XP400		PMF18WH0*	DAF18-4	ACICE0206	AC164012*	AC164301*		✓*	SW006011*	
PIC18F4321	44PT	PCM18XN0*	DVA18PQ440	XLT44PT or XLT44PT3	PMF18WH0*	DAF18-5	XLT44PT or XLT44PT3	AC164020*	AC164305*		✓*	SW006011*	
PIC18F4321	44ML	PCM18XN0*	DVA18XP400	XLT44QFN2	PMF18WH0*	DAF18-4	XLT44QFN2		AC164322*		✓*	SW006011*	

NOTE: See complete list of notes on page 107.

**Development
Systems Products**

MPLAB® ICE 2000 and MPLAB® ICE 4000 Emulator Systems, PRO MATE® II Programmer Socket Modules, MPLAB® In-Circuit Debugger, Software Tools, Programmers and Demonstration Boards (continued)

		MPLAB® ICE 2000 System (1)			MPLAB® ICE 4000 System (2)								
Part Number	Lead Count/ Pkg Type	Processor Module	Device Adapters	Transition Socket	Processor Module	Device Adapters	Transition Socket	PRO MATE® II Socket Module (3,4)	MPLAB® PM3 Socket Module (8)	PICSTART® Plus (5)	MPLAB® ICD 2 (6)	MPLAB® CXX Compiler	Demonstration Boards or Evaluation Kits
PICmicro® Microcontroller Development Tools (continued)													
PIC18F4331	40P	PCM18XL0	DVA18XP400		PMF18WF0	DAF18-4	ACICE0206	AC164012	AC164301	✓	✓	SW006011	DM183011
PIC18F4331	44PT	PCM18XL0	DVA18PQ440	XLT44PT or XLT44PT3	PMF18WF0	DAF18-5	XLT44PT or XLT44PT3	AC164020	AC164305		✓	SW006011	
PIC18F4331	44ML	PCM18XL0	DVA18XP400	XLT44QFN2	PMF18WF0	DAF18-4	XLT44QFN2	AC164012 +AC164034	AC164322	AC164034	✓	SW006011	
PIC18F4410	40P	PCM18XN0	DVA18XP400		PMF18WH0	DAF18-4	ACICE0206	AC164012	AC164301	✓	✓	SW006011	
PIC18F4410	44PT	PCM18XN0	DVA18PQ440	XLT44PT or XLT44PT3	PMF18WH0	DAF18-5	XLT44PT or XLT44PT3	AC164020	AC164305		✓	SW006011	
PIC18F4410	44ML	PCM18XN0	DVA18XP400	XLT44QFN2	PMF18WH0	DAF18-4	XLT44QFN2	AC164012 +AC164034	AC164322	AC164034	✓	SW006011	
PIC18F4420	40P	PCM18XN0	DVA18XP400		PMF18WH0	DAF18-4	ACICE0206	AC164012	AC164301	✓	✓	SW006011	
PIC18F4420	44PT	PCM18XN0	DVA18PQ440	XLT44PT or XLT44PT3	PMF18WH0	DAF18-5	XLT44PT or XLT44PT3	AC164020	AC164305		✓	SW006011	
PIC18F4420	44ML	PCM18XN0	DVA18XP400	XLT44QFN2	PMF18WH0	DAF18-4	XLT44QFN2	AC164012 +AC164034	AC164322	AC164034	✓	SW006011	
PIC18F4431	40P	PCM18XL0	DVA18XP400		PMF18WF0	DAF18-4	ACICE0206	AC164012	AC164301	✓	✓	SW006011	DM183011
PIC18F4431	44PT	PCM18XL0	DVA18PQ440	XLT44PT or XLT44PT3	PMF18WF0	DAF18-5	XLT44PT or XLT44PT3	AC164020	AC164305		✓	SW006011	
PIC18F4431	44ML	PCM18XL0	DVA18XP400	XLT44QFN2	PMF18WF0	DAF18-4	XLT44QFN2	AC164012 +AC164034	AC164322	AC164034	✓	SW006011	
PIC18F4439	40P							AC164012			✓	SW006011	
PIC18F4439	44ML							AC164012 +AC164034			✓	SW006011	
PIC18F4439	44PT							AC164020			✓	SW006011	
PIC18F4455	40P	PCM18XR0	DVA18XP400		PMF18WL0	DAF18-4	ACICE0206	AC164012	AC164301	✓	AC162063**	SW006011	DM163025
PIC18F4455	44ML	PCM18XR0	DVA18XP400	XLT44QFN2	PMF18WL0	DAF18-4	XLT44QFN2	AC164012 +AC164034	AC164322	AC164034	AC162063** +XLT44QFN2	SW006011	DM163025
PIC18F4455	44PT	PCM18XR0	DVA18PQ440	XLT44PT or XLT44PT3	PMF18WL0	DAF18-5	XLT44PT or XLT44PT3	AC164020	AC164305		AC162063** +XLT44PT or XLT44PT3	SW006011	DM163025
PIC18F4480	40P	PCM18XP0	DVA18XP400		PMF18WJ0	DAF18-4	ACICE0206	AC164012	AC164301	✓*	✓	SW006011	DM163011
PIC18F4480	44PT	PCM18XP0	DVA18PQ440	XLT44PT or XLT44PT3	PMF18WJ0	DAF18-5	XLT44PT or XLT44PT3	AC164020	AC164305		✓	SW006011	
PIC18F4480	44ML	PCM18XP0	DVA18XP400	XLT44QFN2	PMF18WJ0	DAF18-4	XLT44QFN2	AC164012 +AC164034	AC164322	AC164034*	✓	SW006011	

NOTE: See complete list of notes on page 107.

MPLAB® ICE 2000 and MPLAB® ICE 4000 Emulator Systems, PRO MATE® II Programmer Socket Modules, MPLAB® In-Circuit Debugger, Software Tools, Programmers and Demonstration Boards (continued)

		MPLAB® ICE 2000 System (1)			MPLAB® ICE 4000 System (2)								
Part Number	Lead Count/ Pkg Type	Processor Module	Device Adapters	Transition Socket	Processor Module	Device Adapters	Transition Socket	PRO MATE® II Socket Module (3,4)	MPLAB® PM3 Socket Module (8)	PICSTART® Plus (5)	MPLAB® ICD 2 (6)	MPLAB® CXX Compiler	Demonstration Boards or Evaluation Kits
PICmicro® Microcontroller Development Tools (continued)													
PIC18F44J10	40P								AC164301*		AC162067**	SW006011	
PIC18F44J10	44PT								AC164305*		AC162067** +XLT44PT or XLT44PT3	SW006011	
PIC18F44J10	44ML								AC164322*		AC162067** +XLT44QFN2	SW006011	
PIC18F4510	40P	PCM18XN0	DVA18XP400		PMF18WH0	DAF18-4	ACICE0206	AC164012	AC164301	✓	✓	SW006011	DM163022
PIC18F4510	44PT	PCM18XN0	DVA18PQ440	XLT44PT or XLT44PT3	PMF18WH0	DAF18-5	XLT44PT or XLT44PT3	AC164020	AC164305		✓	SW006011	
PIC18F4510	44ML	PCM18XN0	DVA18XP400	XLT44QFN2	PMF18WH0	DAF18-4	XLT44QFN2	AC164012 +AC164034	AC164322	AC164034	✓	SW006011	
PIC18F4515	40P	PCM18XN0	DVA18XP400		PMF18WH0	DAF18-4	ACICE0206	AC164012	AC164301	✓	✓	SW006011	
PIC18F4515	44PT	PCM18XN0	DVA18PQ440	XLT44PT or XLT44PT3	PMF18WH0	DAF18-5	XLT44PT or XLT44PT3	AC164020	AC164305		✓	SW006011	
PIC18F4515	44ML	PCM18XN0	DVA18XP400	XLT44QFN2	PMF18WH0	DAF18-4	XLT44QFN2	AC164012 +AC164034	AC164322	AC164034	✓	SW006011	
PIC18F4520	40P	PCM18XN0	DVA18XP400		PMF18WH0	DAF18-4	ACICE0206	AC164012	AC164301	✓	✓	SW006011	DM163022
PIC18F4520	44PT	PCM18XN0	DVA18PQ440	XLT44PT or XLT44PT3	PMF18WH0	DAF18-5	XLT44PT or XLT44PT3	AC164020	AC164305		✓	SW006011	
PIC18F4520	44ML	PCM18XN0	DVA18XP400	XLT44QFN2	PMF18WH0	DAF18-4	XLT44QFN2	AC164012 +AC164034	AC164322	AC164034	✓	SW006011	
PIC18F4525	40P	PCM18XN0	DVA18XP400		PMF18WH0	DAF18-4	ACICE0206	AC164012	AC164301	✓	✓	SW006011	
PIC18F4525	44PT	PCM18XN0	DVA18PQ440	XLT44PT or XLT44PT3	PMF18WH0	DAF18-5	XLT44PT or XLT44PT3	AC164020	AC164305		✓	SW006011	
PIC18F4525	44ML	PCM18XN0	DVA18XP400	XLT44QFN2	PMF18WH0	DAF18-4	XLT44QFN2	AC164012 +AC164034	AC164322	AC164034	✓	SW006011	
PIC18F4539	40P							AC164012			✓	SW006011	
PIC18F4539	44ML							AC164012 +AC164034			✓	SW006011	
PIC18F4539	44PT							AC164020			✓	SW006011	
PIC18F4550	40P	PCM18XR0	DVA18XP400		PMF18WL0	DAF18-4	ACICE0206	AC164012	AC164301	✓*	AC162063**	SW006011	DM163025
PIC18F4550	44ML	PCM18XR0	DVA18XP400	XLT44QFN2	PMF18WL0	DAF18-4	XLT44QFN2	AC164012 +AC164034	AC164322	AC164034*	AC162063** +XLT44QFN2	SW006011	DM163025
PIC18F4550	44PT	PCM18XR0	DVA18PQ440	XLT44PT or XLT44PT3	PMF18WL0	DAF18-5	XLT44PT or XLT44PT3	AC164020	AC164305		AC162063** +XLT44PT or XLT44PT3	SW006011	DM163025

NOTE: See complete list of notes on page 107.

Development Systems Products

MPLAB® ICE 2000 and MPLAB® ICE 4000 Emulator Systems, PRO MATE® II Programmer Socket Modules, MPLAB® In-Circuit Debugger, Software Tools, Programmers and Demonstration Boards (continued)

		MPLAB® ICE 2000 System (1)			MPLAB® ICE 4000 System (2)								
Part Number	Lead Count/ Pkg Type	Processor Module	Device Adapters	Transition Socket	Processor Module	Device Adapters	Transition Socket	PRO MATE® II Socket Module (3,4)	MPLAB® PM3 Socket Module (8)	PICSTART® Plus (5)	MPLAB® ICD 2 (6)	MPLAB® CXX Compiler	Demonstration Boards or Evaluation Kits
PICmicro® Microcontroller Development Tools (continued)													
PIC18F4580	40P	PCM18XP0	DVA18XP400		PMF18WJ0	DAF18-4	ACICE0206	AC164012	AC164301	✓*	✓	SW006011	DM163011
PIC18F4580	44PT	PCM18XP0	DVA18PQ440	XLT44PT or XLT44PT3	PMF18WJ0	DAF18-5	XLT44PT or XLT44PT3	AC164020	AC164305		✓	SW006011	
PIC18F4580	44ML	PCM18XP0	DVA18XP400	XLT44QFN2	PMF18WJ0	DAF18-4	XLT44QFN2	AC164012 +AC164034	AC164322	AC164034*	✓	SW006011	
PIC18F4585	40P	PCM18XP0	DVA18XP400		PMF18WJ0	DAF18-4	ACICE0206	AC164012	AC164301	✓	✓	SW006011	DM163011
PIC18F4585	44PT	PCM18XP0	DVA18PQ440	XLT44PT or XLT44PT3	PMF18WJ0	DAF18-5	XLT44PT or XLT44PT3	AC164020	AC164305		✓	SW006011	
PIC18F4585	44ML	PCM18XP0	DVA18XP400	XLT44QFN2	PMF18WJ0	DAF18-4	XLT44QFN2	AC164012 +AC164034	AC164322	AC164034	✓	SW006011	
PIC18F45J10	40P								AC164301*		AC162067**	SW006011	
PIC18F45J10	44PT								AC164305*		AC162067** +XLT44PT or XLT44PT3	SW006011	
PIC18F45J10	44ML								AC164322*		AC162067** +XLT44QFN2	SW006011	
PIC18F4610	40P	PCM18XN0	DVA18XP400		PMF18WH0	DAF18-4	ACICE0206	AC164012	AC164301	✓	✓	SW006011	
PIC18F4610	44PT	PCM18XN0	DVA18PQ440	XLT44PT or XLT44PT3	PMF18WH0	DAF18-5	XLT44PT or XLT44PT3	AC164020	AC164305		✓	SW006011	
PIC18F4610	44ML	PCM18XN0	DVA18XP400	XLT44QFN2	PMF18WH0	DAF18-4	XLT44QFN2	AC164012 +AC164034	AC164322	AC164034	✓	SW006011	
PIC18F4620	40P	PCM18XN0	DVA18XP400		PMF18WH0	DAF18-4	ACICE0206	AC164012	AC164301	✓	✓	SW006011	DM163026, DM163027-2
PIC18F4620	44PT	PCM18XN0	DVA18PQ440	XLT44PT or XLT44PT3	PMF18WH0	DAF18-5	XLT44PT or XLT44PT3	AC164020	AC164305		✓	SW006011	
PIC18F4620	44ML	PCM18XN0	DVA18XP400	XLT44QFN2	PMF18WH0	DAF18-4	XLT44QFN2	AC164012 +AC164034	AC164322	AC164034	✓	SW006011	
PIC18F4680	40P	PCM18XP0	DVA18XP400		PMF18WJ0	DAF18-4	ACICE0206	AC164012	AC164301	✓	✓	SW006011	DM163011
PIC18F4680	44PT	PCM18XP0	DVA18PQ440	XLT44PT or XLT44PT3	PMF18WJ0	DAF18-5	XLT44PT or XLT44PT3	AC164020	AC164305		✓	SW006011	
PIC18F4680	44ML	PCM18XP0	DVA18XP400	XLT44QFN2	PMF18WJ0	DAF18-4	XLT44QFN2	AC164012 +AC164034	AC164322	AC164034	✓	SW006011	
PIC18F6310	64PT	PCM18XQ0	DVA1003	XLT64PT2 or XLT64PT5	PMF18WK0	DAF18-6	XLT64PT2 or XLT64PT5	AC174008	AC164303		✓	SW006011	
PIC18F6390	64PT	PCM18XQ0	DVA1003	XLT64PT2 or XLT64PT5	PMF18WK0	DAF18-6	XLT64PT2 or XLT64PT5	AC174008	AC164303		✓	SW006011	DM163028
PIC18F6410	64PT	PCM18XQ0	DVA1003	XLT64PT2 or XLT64PT5	PMF18WK0	DAF18-6	XLT64PT2 or XLT64PT5	AC174008	AC164303		✓	SW006011	

NOTE: See complete list of notes on page 107.

MPLAB® ICE 2000 and MPLAB® ICE 4000 Emulator Systems, PRO MATE® II Programmer Socket Modules, MPLAB® In-Circuit Debugger, Software Tools, Programmers and Demonstration Boards (continued)

		MPLAB® ICE 2000 System (1)			MPLAB® ICE 4000 System (2)								
Part Number	Lead Count/ Pkg Type	Processor Module	Device Adapters	Transition Socket	Processor Module	Device Adapters	Transition Socket	PRO MATE® II Socket Module (3,4)	MPLAB® PM3 Socket Module (8)	PICSTART® Plus (5)	MPLAB® ICD 2 (6)	MPLAB® CXX Compiler	Demonstration Boards or Evaluation Kits
PICmicro® Microcontroller Development Tools (continued)													
PIC18F6490	64PT	PCM18XQ0	DVA1003	XLT64PT2 or XLT64PT5	PMF18WK0	DAF18-6	XLT64PT2 or XLT64PT5	AC174008	AC164303		✓	SW006011	DM163028
PIC18F6520	64PT	PCM18XE1	DVA18PQ640	XLT64PT2 or XLT64PT5	PMF18WA2	DAF18-6	XLT64PT2 or XLT64PT5	AC174008	AC164303		✓	SW006011	DM183022
PIC18F6525	64PT	PCM18XK0	DVA18PQ802	XLT64PT2 or XLT64PT5	PMF18WE0	DAF18-1	XLT64PT2 or XLT64PT5	AC174008	AC164303		✓	SW006011	
PIC18F6527	64PT	PCM18XS0*	DVA1003	XLT64PT2 or XLT64PT5	PMF18WS0*	DAF18-6	XLT64PT2 or XLT64PT5	AC174008*	AC164303*		✓*	SW006011	
PIC18F6585	68L	PCM18XK0	DVA18PQ802	XLT68L1	PMF18WE0	DAF18-1	XLT68L1	AC174007	AC164308		✓	SW006011	
PIC18F6585	64PT	PCM18XK0	DVA18PQ802	XLT64PT2 or XLT64PT5	PMF18WE0	DAF18-1	XLT64PT2 or XLT64PT5	AC174008	AC164303		✓	SW006011	DM163015
PIC18F65J10	64PT								AC164327**		AC162062** ⁽⁹⁾	SW006011	DM183022
PIC18F65J15	64PT								AC164327**		AC162062** ⁽⁹⁾	SW006011	DM183022
PIC18F6620	64PT	PCM18XE1	DVA18PQ640	XLT64PT2 or XLT64PT5	PMF18WA2	DAF18-6	XLT64PT2 or XLT64PT5	AC174008	AC164303	✓ (7)*	✓	SW006011	DM183022
PIC18F6621	64PT	PCM18XK0	DVA18PQ802	XLT64PT2 or XLT64PT5	PMF18WE0	DAF18-1	XLT64PT2 or XLT64PT5	AC174008	AC164303		✓	SW006011	
PIC18F6622	64PT	PCM18XS0	DVA1003	XLT64PT2 or XLT64PT5	PMF18WS0	DAF18-6	XLT64PT2 or XLT64PT5	AC174008*	AC164303*		✓*	SW006011	
PIC18F6627	64PT	PCM18XS0	DVA1003	XLT64PT2 or XLT64PT5	PMF18WS0	DAF18-6	XLT64PT2 or XLT64PT5	AC174008	AC164303		✓	SW006011	DM183022
PIC18F6680	68L	PCM18XK0	DVA18PQ802	XLT68L1	PMF18WE0	DAF18-1	XLT68L1	AC174007	AC164308		✓	SW006011	
PIC18F6680	64PT	PCM18XK0	DVA18PQ802	XLT64PT2 or XLT64PT5	PMF18WE0	DAF18-1	XLT64PT2 or XLT64PT5	AC174008	AC164303		✓	SW006011	DM163015
PIC18F66J10	64PT								AC164327**		AC162062** ⁽⁹⁾	SW006011	DM183022
PIC18F66J15	64PT								AC164327**		AC162062** ⁽⁹⁾	SW006011	DM183022
PIC18F66J60	64PT								AC164327**		AC162064**	SW006011*	
PIC18F66J65	64PT								AC164327**		AC162064**	SW006011*	
PIC18F6720	64PT	PCM18XE1	DVA18PQ640	XLT64PT2 or XLT64PT5	PMF18WA2	DAF18-6	XLT64PT2 or XLT64PT5	AC174008	AC164303	✓ (7)*	✓	SW006011	DM183022
PIC18F6722	64PT	PCM18XS0	DVA1003	XLT64PT2 or XLT64PT5	PMF18WS0	DAF18-6	XLT64PT2 or XLT64PT5	AC174008	AC164303		✓	SW006011	DM183022
PIC18F67J10	64PT								AC164327**		AC162062** ⁽⁹⁾	SW006011	DM183022
PIC18F67J60	64PT								AC164327**		AC162064**	SW006011*	
PIC18F8310	80PT	PCM18XQ0	DVA1003	XLT80PT or XLT80PT3	PMF18WK0	DAF18-6	XLT80PT or XLT80PT3	AC174011	AC164304		✓	SW006011	

NOTE: See complete list of notes on page 107.

**Development
Systems Products**

MPLAB® ICE 2000 and MPLAB® ICE 4000 Emulator Systems, PRO MATE® II Programmer Socket Modules, MPLAB® In-Circuit Debugger, Software Tools, Programmers and Demonstration Boards (continued)

		MPLAB® ICE 2000 System (1)			MPLAB® ICE 4000 System (2)								
Part Number	Lead Count/ Pkg Type	Processor Module	Device Adapters	Transition Socket	Processor Module	Device Adapters	Transition Socket	PRO MATE® II Socket Module (3,4)	MPLAB® PM3 Socket Module (8)	PICSTART® Plus (5)	MPLAB® ICD 2 (6)	MPLAB® CXX Compiler	Demonstration Boards or Evaluation Kits
PICmicro® Microcontroller Development Tools (continued)													
PIC18F8390	80PT	PCM18XQ0	DVA1003	XLT80PT or XLT80PT3	PMF18WK0	DAF18-6	XLT80PT or XLT80PT3	AC174011	AC164304		✓	SW006011	DM163028
PIC18F8410	80PT	PCM18XQ0	DVA1003	XLT80PT or XLT80PT3	PMF18WK0	DAF18-6	XLT80PT or XLT80PT3	AC174011	AC164304		✓	SW006011	
PIC18F8490	80PT	PCM18XQ0	DVA1003	XLT80PT or XLT80PT3	PMF18WK0	DAF18-6	XLT80PT or XLT80PT3	AC174011	AC164304		✓	SW006011	DM163028
PIC18F8520	80PT	PCM18XE1	DVA18PQ800	XLT80PT or XLT80PT3	PMF18WA2	DAF18-6	XLT80PT or XLT80PT3	AC174011	AC164304		✓	SW006011	DM183022
PIC18F8525	80PT	PCM18XK0	DVA18PQ802	XLT80PT or XLT80PT3	PMF18WE0	DAF18-1	XLT80PT or XLT80PT3	AC174011	AC164304		✓	SW006011	
PIC18F8527	80PT	PCM18XS0	DVA1003	XLT80PT or XLT80PT3	PMF18WS0	DAF18-6	XLT80PT or XLT80PT3	AC174011*	AC164304*		✓*	SW006011	
PIC18F8585	80PT	PCM18XK0	DVA18PQ802	XLT80PT or XLT80PT3	PMF18WE0	DAF18-1	XLT80PT or XLT80PT3	AC174011	AC164304		✓	SW006011	DM163015
PIC18F85J10	80PT								AC164328**		AC162062** ⁽⁹⁾	SW006011	DM183022
PIC18F85J15	80PT								AC164328**		AC162062** ⁽⁹⁾	SW006011	DM183022
PIC18F8620	80PT	PCM18XE1	DVA18PQ800	XLT80PT or XLT80PT3	PMF18WA2	DAF18-6	XLT80PT or XLT80PT3	AC174011	AC164304	✓ (7)	✓	SW006011	DM183022
PIC18F8621	80PT	PCM18XK0	DVA18PQ802	XLT80PT or XLT80PT3	PMF18WE0	DAF18-1	XLT80PT or XLT80PT3	AC174011	AC164304		✓	SW006011	
PIC18F8622	80PT	PCM18XS0	DVA1003	XLT80PT or XLT80PT3	PMF18WS0	DAF18-6	XLT80PT or XLT80PT3	AC174011*	AC164304*		✓*	SW006011	
PIC18F8627	80PT	PCM18XS0	DVA1003	XLT80PT or XLT80PT3	PMF18WS0	DAF18-6	XLT80PT or XLT80PT3	AC174011	AC164304		✓	SW006011	DM183022
PIC18F8680	80PT	PCM18XK0	DVA18PQ802	XLT80PT or XLT80PT3	PMF18WE0	DAF18-1	XLT80PT or XLT80PT3	AC174011	AC164304		✓	SW006011	DM163015
PIC18F86J10	80PT								AC164328**		AC162062** ⁽⁹⁾	SW006011	DM183022
PIC18F86J15	80PT								AC164328**		AC162062** ⁽⁹⁾	SW006011	DM183022
PIC18F86J60	80PT								AC164328**		AC162064**	SW006011*	
PIC18F86J65	80PT								AC164328**		AC162064**	SW006011*	
PIC18F8720	80PT	PCM18XE1	DVA18PQ800	XLT80PT or XLT80PT3	PMF18WA2	DAF18-6	XLT80PT or XLT80PT3	AC174011	AC164304	✓ (7)	✓	SW006011	DM183022
PIC18F8722	80PT	PCM18XS0	DVA1003	XLT80PT or XLT80PT3	PMF18WS0	DAF18-6	XLT80PT or XLT80PT3	AC174011	AC164304		✓	SW006011	DM183022
PIC18F87J10	80PT								AC164328**		AC162062** ⁽⁹⁾	SW006011	DM183022
PIC18F87J60	80PT								AC164328**		AC162064**	SW006011*	

NOTE: See complete list of notes on page 107.

MPLAB® ICE 2000 and MPLAB® ICE 4000 Emulator Systems, PRO MATE® II Programmer Socket Modules, MPLAB® In-Circuit Debugger, Software Tools, Programmers and Demonstration Boards (continued)

		MPLAB® ICE 2000 System (1)			MPLAB® ICE 4000 System (2)								
Part Number	Lead Count/ Pkg Type	Processor Module	Device Adapters	Transition Socket	Processor Module	Device Adapters	Transition Socket	PRO MATE® II Socket Module (3,4)	MPLAB® PM3 Socket Module (8)	PICSTART® Plus (5)	MPLAB® ICD 2 (6)	MPLAB® CXX Compiler	Demonstration Boards or Evaluation Kits
PICmicro® Microcontroller Development Tools (continued)													
PIC18F96J60	100PT								AC164323**		AC162064**	SW006011*	
PIC18F96J65	100PT								AC164323**		AC162064**	SW006011*	
PIC18F97J60	100PT								AC164323**		AC162064**	SW006011*	
PIC24FJ64GA006	64PT								AC164327**		AC162065**	SW006012*	DM240001**
PIC24FJ64GA008	80PT								AC164328**		AC162065**	SW006012*	DM240001**
PIC24FJ64GA010	100PT								AC164323**		AC162065**	SW006012*	DM240001**
PIC24FJ96GA006	64PT								AC164327**		AC162065**	SW006012*	DM240001**
PIC24FJ96GA008	80PT								AC164328**		AC162065**	SW006012*	DM240001**
PIC24FJ96GA010	100PT								AC164323**		AC162065**	SW006012*	DM240001**
PIC24FJ128GA006	64PT								AC164327**		AC162065**	SW006012*	DM240001**
PIC24FJ128GA008	80PT								AC164328**		AC162065**	SW006012*	DM240001**
PIC24FJ128GA010	100PT								AC164323**		AC162065**	SW006012*	DM240001**
rfPIC® Microcontroller Development Tools													
rfPIC12C509AF	20JW	PCM16XA0	DVA12XP080					AC124001	AC164301	✓			
rfPIC12C509AF	20SS	PCM16XA0	DVA12XP080	XLT20SS				AC124002	AC164307	✓			
rfPIC12C509AG	18JW	PCM16XA0	DVA12XP080					AC124001	AC164301	✓ (7)			
rfPIC12C509AG	18SO	PCM16XA0	DVA12XP080	XLT18SO				AC124002	AC164302	✓ (7)			
rfPIC12F675F	20SS	PCM12XB0	DVA12XP081	XLT20SS				AC124002	AC164307	✓ (7)*			DV164102 AC164101 AC164103
rfPIC12F675H	20SS	PCM12XB0	DVA12XP081	XLT20SS				AC124002	AC164307	✓ (7)*			
rfPIC12F675K	20SS	PCM12XB0	DVA12XP081	XLT20SS				AC124002	AC164307	✓ (7)*			DV164102 AC164102 AC164104
rfRXD0420	32LQ												DV164102
rfRXD0920	32LQ												

NOTE: See complete list of notes on page 107.

Development Systems Products

MPLAB® ICE 2000 and MPLAB® ICE 4000 Emulator Systems, PRO MATE® II Programmer Socket Modules, MPLAB® In-Circuit Debugger, Software Tools, Programmers and Demonstration Boards (continued)

		MPLAB® ICE 2000 System (1)			MPLAB® ICE 4000 System (2)								
Part Number	Lead Count/ Pkg Type	Processor Module	Device Adapters	Transition Socket	Processor Module	Device Adapters	Transition Socket	PRO MATE® II Socket Module (3,4)	MPLAB® PM3 Socket Module (8)	PICSTART® Plus (5)	MPLAB® ICD 2 (6)	MPLAB® CXX Compiler	Demonstration Boards or Evaluation Kits
dsPIC® DSC Development Tools													
dsPIC30F2010	28SO				PMF30XA1	DAF30-4	XLT28SO	AC30F004	AC164302		✓	SW006012	DM300017
dsPIC30F2010	28SP				PMF30XA1	DAF30-4	ACICE0204	AC30F004	AC164301		✓	SW006012	DM300017 DM300018
dsPIC30F2010	28MM				PMF30XA1	DAF30-4	XLT28QFN4		AC164322		✓	SW006012	
dsPIC30F2011	18SO				PMF30XA1	DAF30-4	XLT18SO	AC30F005	AC164302		✓*	SW006012	
dsPIC30F2011	18P				PMF30XA1	DAF30-4	ACICE0202	AC30F005	AC164301		✓*	SW006012	DM300018
dsPIC30F2011	28ML				PMF30XA1	DAF30-4			AC164322		✓*	SW006012	
dsPIC30F2012	28SO				PMF30XA1	DAF30-4	XLT28SO	AC30F004	AC164302		✓*	SW006012	DM300017
dsPIC30F2012	28SP				PMF30XA1	DAF30-4	ACICE0204	AC30F004	AC164301		✓*	SW006012	DM300017, DM300018
dsPIC30F2012	28ML				PMF30XA1	DAF30-4	XLT28QFN4		AC164322		✓*	SW006012	
dsPIC30F3010	28SO				PMF30XA1	DAF30-4	XLT28SO	AC30F004	AC164302		✓	SW006012	DM300017
dsPIC30F3010	28SP				PMF30XA1	DAF30-4	ACICE0204	AC30F004	AC164301		✓	SW006012	DM300017, DM300018
dsPIC30F3010	44ML				PMF30XA1	DAF30-4	XLT44QFN4		AC164322		✓	SW006012	
dsPIC30F3011	40P				PMF30XA1	DAF30-4	ACICE0206	AC30F003	AC164301		✓	SW006012	DM30018
dsPIC30F3011	44PT				PMF30XA1	DAF30-3	XLT44PT or XLT44PT3	AC30F006	AC164305		✓	SW006012	
dsPIC30F3011	44ML				PMF30XA1	DAF30-4	XLT44QFN2		AC164322		✓	SW006012	
dsPIC30F3012	18SO				PMF30XA1	DAF30-4	XLT18SO		AC164302		✓	SW006012	
dsPIC30F3012	18P				PMF30XA1	DAF30-4	ACICE0202		AC164301		✓	SW006012	DM300018
dsPIC30F3012	44ML				PMF30XA1	DAF30-4	XLT44QFN5*		AC164322		✓	SW006012	
dsPIC30F3013	28SO				PMF30XA1	DAF30-4	XLT28SO	AC30F004	AC164302		✓	SW006012	DM300017
dsPIC30F3013	28SP				PMF30XA1	DAF30-4	ACICE0204	AC30F004	AC164301		✓	SW006012	DM300017, DM300018
dsPIC30F3013	44ML				PMF30XA1	DAF30-4	XLT44QFN3*		AC164322		✓	SW006012	
dsPIC30F3014	40P				PMF30XA1	DAF30-4	ACICE0206	AC30F003	AC164301		✓	SW006012	DM300018
dsPIC30F3014	44PT				PMF30XA1	DAF30-3	XLT44PT or XLT44PT3	AC30F006	AC164305		✓	SW006012	
dsPIC30F3014	44ML				PMF30XA1	DAF30-4	XLT44QFN2		AC164322		✓	SW006012	
dsPIC30F4011	40P				PMF30XA1	DAF30-4	ACICE0206	AC30F003	AC164301		✓	SW006012	DM300018
dsPIC30F4011	44PT				PMF30XA1	DAF30-3	XLT44PT or XLT44PT3	AC30F006	AC164305		✓	SW006012	
dsPIC30F4011	44ML				PMF30XA1	DAF30-4	XLT44QFN2		AC164322		✓	SW006012	

NOTE: See complete list of notes on page 107.

MPLAB® ICE 2000 and MPLAB® ICE 4000 Emulator Systems, PRO MATE® II Programmer Socket Modules, MPLAB® In-Circuit Debugger, Software Tools, Programmers and Demonstration Boards (continued)

		MPLAB® ICE 2000 System (1)			MPLAB® ICE 4000 System (2)								
Part Number	Lead Count/ Pkg Type	Processor Module	Device Adapters	Transition Socket	Processor Module	Device Adapters	Transition Socket	PRO MATE® II Socket Module (3,4)	MPLAB® PM3 Socket Module (8)	PICSTART® Plus (5)	MPLAB® ICD 2 (6)	MPLAB® CXX Compiler	Demonstration Boards or Evaluation Kits
dsPIC® DSC Development Tools (continued)													
dsPIC30F4012	28SO				PMF30XA1	DAF30-4	XLT28SO	AC30F004	AC164302		✓	SW006012	DM300017
dsPIC30F4012	28SP				PMF30XA1	DAF30-4	ACICE0204	AC30F004	AC164301		✓	SW006012	DM300017, DM300018
dsPIC30F4012	44ML				PMF30XA1	DAF30-4	XLT44QFN4		AC164322		✓	SW006012	
dsPIC30F4013	40P				PMF30XA1	DAF30-4	ACICE0206	AC30F003	AC164301		✓	SW006012	DM300018
dsPIC30F4013	44PT				PMF30XA1	DAF30-3	XLT44PT or XLT44PT3	AC30F006	AC164305		✓	SW006012	
dsPIC30F4013	44ML				PMF30XA1	DAF30-4	XLT44QFN2		AC164322		✓	SW006012	
dsPIC30F5011	64PT				PMF30XA1	DAF30-2	XLT64PT2 or XLT64PT5	AC30F008	AC164319		✓	SW006012	DM300016
dsPIC30F5013	80PT				PMF30XA1	DAF30-2	XLT80PT or XLT80PT3	AC30F007	AC164320		✓	SW006012	DM300014, DM300004-1, DM300004-2
dsPIC30F5015	64PT				PMF30XA1	DAF30-2	XLT64PT2 or XLT64PT5	AC30F008*	AC164319*		✓*	SW006012	
dsPIC30F5016	80PT				PMF30XA1	TBD	TBD	AC30F007*	AC164320*		✓*	SW006012	
dsPIC30F6010	80PF				PMF30XA1	DAF30-2	XLT80PT2	AC30F001	AC164314		✓	SW006012	DM300020
dsPIC30F6010A	80PF				PMF30XA1*	DAF30-2	XLT80PT2		AC164314*		✓*	SW006012	DM300020
dsPIC30F6010A	80PT				PMF30XA1*	DAF30-2	XLT80PT or XLT80PT3	AC30F007*	AC164320*		✓*	SW006012	DM300020
dsPIC30F6011	64PF				PMF30XA1	DAF30-2	XLT64PT3 or XLT64PT4	AC30F002	AC164313		✓	SW006012	DM300016
dsPIC30F6011A	64PF				PMF30XA1	DAF30-2	XLT64PT3 or XLT64PT4	AC30F002*	AC164313*		✓*	SW006012	
dsPIC30F6011A	64PT				PMF30XA1	DAF30-2	XLT64PT2 or XLT64PT5	AC30F008*	AC164319*		✓*	SW006012	DM300016
dsPIC30F6012	64PF				PMF30XA1	DAF30-2	XLT64PT3 or XLT64PT4	AC30F002	AC164313		✓	SW006012	DM300016
dsPIC30F6012A	64PF				PMF30XA1	DAF30-2	XLT64PT3 or XLT64PT4	AC30F002*	AC164313*		✓*	SW006012	
dsPIC30F6012A	64PT				PMF30XA1	DAF30-2	XLT64PT2 or XLT64PT5	AC30F008*	AC164319*		✓*	SW006012	DM300016
dsPIC30F6013	80PF				PMF30XA1	DAF30-2	XLT80PT2	AC30F001	AC164314		✓	SW006012	DM300014
dsPIC30F6013A	80PF				PMF30XA1	DAF30-2	XLT80PT2	AC30F001*	AC164314*		✓*	SW006012	
dsPIC30F6013A	80PT				PMF30XA1	DAF30-2	XLT80PT or XLT80PT3	AC30F007*	AC164320*		✓*	SW006012	DM300014

NOTE: See complete list of notes on page 107.

**Development
Systems Products**

MPLAB® ICE 2000 and MPLAB® ICE 4000 Emulator Systems, PRO MATE® II Programmer Socket Modules, MPLAB® In-Circuit Debugger, Software Tools, Programmers and Demonstration Boards (continued)

		MPLAB® ICE 2000 System (1)			MPLAB® ICE 4000 System (2)								
Part Number	Lead Count/ Pkg Type	Processor Module	Device Adapters	Transition Socket	Processor Module	Device Adapters	Transition Socket	PRO MATE® II Socket Module (3,4)	MPLAB® PM3 Socket Module (8)	PICSTART® Plus (5)	MPLAB® ICD 2 (6)	MPLAB® CXX Compiler	Demonstration Boards or Evaluation Kits
dsPIC® DSC Development Tools (continued)													
dsPIC30F6014	80PF				PMF30XA1	DAF30-2	XLT80PT2	AC30F001	AC164314		✓	SW006012	DM300014, DM300004-1, DM300004-2
dsPIC30F6014A	80PF				PMF30XA1	DAF30-2	XLT80PT2	AC30F001*	AC164314*		✓*	SW006012	
dsPIC30F6014A	80PT				PMF30XA1	DAF30-2	XLT80PT or XLT80PT3	AC30F007*	AC164320*		✓*	SW006012	DM300014, DM300004-1, DM300004-2
dsPIC30F6015	64PT				TBD	TBD	TBD		AC164319*		✓*	SW006012	
dsPIC33FJ64GP206	64PT								TBD		✓*	SW006012*	DM240001**, DM300019**
dsPIC33FJ64GP306	64PT								TBD		✓*	SW006012*	DM240001**, DM300019**
dsPIC33FJ64GP310	100PT								TBD		✓*	SW006012*	DM240001**, DM300019**
dsPIC33FJ64GP706	64PT								TBD		✓*	SW006012*	DM240001**, DM300019**
dsPIC33FJ64GP708	80PT								TBD		✓*	SW006012*	DM240001**, DM300019**
dsPIC33FJ64GP710	100PT								TBD		✓*	SW006012*	DM240001**, DM300019**
dsPIC33FJ128GP206	64PT								TBD		✓*	SW006012*	DM240001**, DM300019**
dsPIC33FJ128GP306	64PT								TBD		✓*	SW006012*	DM240001**, DM300019**
dsPIC33FJ128GP310	100PT								TBD		✓*	SW006012*	DM240001**, DM300019**
dsPIC33FJ128GP706	64PT								TBD		✓*	SW006012*	DM240001**, DM300019**
dsPIC33FJ128GP708	80PT								TBD		✓*	SW006012*	DM240001**, DM300019**
dsPIC33FJ128GP710	100PT								TBD		✓*	SW006012*	DM240001**, DM300019**
dsPIC33FJ256GP506	64PT								TBD		✓*	SW006012*	DM240001**, DM300019**
dsPIC33FJ256GP510	100PT								TBD		✓*	SW006012*	DM240001**, DM300019**
dsPIC33FJ256GP710	100PT								TBD		✓*	SW006012*	DM240001**, DM300019**
dsPIC33FJ64MC506	64PT								TBD		✓*	SW006012*	

NOTE: See complete list of notes on page 107.

MPLAB® ICE 2000 and MPLAB® ICE 4000 Emulator Systems, PRO MATE® II Programmer Socket Modules, MPLAB® In-Circuit Debugger, Software Tools, Programmers and Demonstration Boards (continued)

Part Number	Lead Count/ Pkg Type	MPLAB® ICE 2000 System (1)			MPLAB® ICE 4000 System (2)			PRO MATE® II Socket Module (3,4)	MPLAB® PM3 Socket Module (8)	PICSTART® Plus (5)	MPLAB® ICD 2 (6)	MPLAB® CXX Compiler	Demonstration Boards or Evaluation Kits
		Processor Module	Device Adapters	Transition Socket	Processor Module	Device Adapters	Transition Socket						
dsPIC33FJ64MC508	80PT							TBD			✓*	SW006012*	
dsPIC33FJ64MC510	100PT							TBD			✓*	SW006012*	
dsPIC33FJ64MC706	64PT							TBD			✓*	SW006012*	
dsPIC33FJ64MC710	100PT							TBD			✓*	SW006012*	
dsPIC33FJ128MC506	64PT							TBD			✓*	SW006012*	
dsPIC33FJ128MC510	100PT							TBD			✓*	SW006012*	
dsPIC33FJ128MC706	64PT							TBD			✓*	SW006012*	
dsPIC33FJ128MC708	80PT							TBD			✓*	SW006012*	
dsPIC33FJ128MC710	100PT							TBD			✓*	SW006012*	
dsPIC33FJ256MC510	100PT							TBD			✓*	SW006012*	
dsPIC33FJ256MC710	100PT							TBD			✓*	SW006012*	

NOTE: See complete list of notes on page 107.

NOTES - MPLAB® ICE 2000 and MPLAB® ICE 4000 Emulator Systems, PRO MATE® II Programmer Socket Modules, MPLAB® In-Circuit Debugger, Software Tools, Programmers and Demonstration Boards

- NOTES** 1: MPLAB® ICE 2000 pod available separately. (ICE2000)
 2: MPLAB® ICE 4000 pod available separately. (ICE4000)
 3: PRO MATE® II Programmer unit (no longer available). (DV007003)
 4: Optional In-Circuit Serial Programming™ (ICSP™) Socket for PRO MATE® II available separately. (AC004004)
 5: PICSTART® Plus (DV003001)
 6: MPLAB® ICD 2 In-Circuit Debugger. Configurations are:
 (DV164005) ICD 2 module, USB cable and ICD cable.
 (DV164006) ICD 2 module, USB cable, ICD cable, serial cable, PICDEM™ 2 Plus and power supply.
 (DV164007) ICD 2 module, USB cable, ICD cable, serial cable and power supply;
 (DV164030) ICD 2 module, USB cable, ICD cable, serial cable and dsPICDEM™ Starter Demo Board;
 (AC162049) ICD 2 Universal Programming Module;
 (AC162051) ICD or ICD 2 28/40 PDIP Header Interface Board.
 7: Custom adapter required; not available from Microchip. See "Readme" for PICSTART® Plus.
 8: MPLAB® PM3 Programmer Unit available separately. (DV007004). ICSP™ function is built-in with MPLAB® PM3 Programmer.
 (AC164350) MPLAB® PM3 Adapter for PRO MATE® II Socket modules.
 9: Supported natively by ICD 2, but ICD 2 header gives user access to I/O pins RB6 and RB7.

* Future support. Contact Microchip web site at www.microchip.com for availability.

** New/Future product. Contact Microchip web site at www.microchip.com for availability.

✓ Supported with basic configuration. If a part number is listed in the column, that part is required and available separately.

Development Systems Products

Demonstration Boards and Evaluation Kits	
Part Number	Description
PICmicro® Demonstration Kits	
DM163001	PICDEM™ 1 Demo Board for PIC16C5X, 55X, 62X, CE62X, 71, 710, 711, 715, 770, 771, 83, 84, and PIC17C42, 43, 44
DM163003	PICDEM™ 3 Demo Board for PIC16C923, 924 LCD
DM163006	PICDEM™ 18R Demo Board for PIC18C601/801
DM163014	PICDEM™ 4 Demo Board for PIC12F629, 675, PIC16F630, 676, 684, 627A, 628A, 648A, 818, 819, 87, 88, PIC18F1220, 1320
DM163022	PICDEM™ 2 Plus Demo Board for PIC16C62, 63, 64, 65, 66, 67, 72, 73, 74, 76, 77, 87X, 773, 774 and PIC18CXX2, 642, 662, and PIC18FXXX
DM163026	Low-Power Solutions Demo Board
DM163028	PICDEM™ LCD Demo Board (uses 64L/80L PIC18FXX90 and 28L/40L PIC16F91X family)
DM163029	PICDEM™ Mechatronics Demo Board
DV164101	PICkit™ 1 8/14P Flash Development Kit for PIC12F629, 675 and PIC16F630, 676
DV164102	rfPIC® Development Kit 1
DV164120	PICkit™ 2 Starter Kit
PG164120	PICkit™ 2 Microcontroller Programmer
AC164101	rfPIC® Transmitter Module (433.92 MHz)
AC164102	rfPIC® Transmitter Module (315 MHz)
AC164103	rfRXD Receiver Module (433.92 MHz)
AC164104	rfRXD Receiver Module (315 MHz)
AC164120	Signal Analysis PICtail™ Daughter Board
AC163020	PIC10F2XX Programmer Adapter
AC163021	6L SOT-23 to 8P DIP Adapter Kit
DM173001	PICDEM™ 17 Demo Board for PIC17CXX
DM183011	PICDEM™ MC Development Board (uses 28L/40L PIC18FXX31 family)
DM183021	PICDEM™ MC LV Development Board (uses 28L PIC18F2331, 2431, dsPIC30F family)
DM183022	PICDEM™ HPC Explorer Board
DM240001**	Explorer 16 Demo Board
Connectivity Demonstration Kits	
DM163004-LT	PICDEM.net™ TCP/IP Demo Board (with no text book)
DM163005	PICDEM™ LIN Demo Board for PIC16C432/433 LIN bus
DM163007	PICDEM™ CAN-LIN 1 Demo Board (uses 68L/84L PIC18CXX8 family)
DM163010	PICDEM™ USB Demo Board for PIC16C7X5
DM163011	PICDEM™ CAN-LIN 2 Demo Board (uses 28L/40L PIC18FXX8 and PIC18FXX8X family)
DM163015	PICDEM™ CAN-LIN 3 Demo Board (uses 64L/80L PIC18FXX8X family)
DM163025	PICDEM™ FS USB Demo Board
DM163027-2	PICDEM™ Z 2.4 GHz Demonstration Kit

NOTE: See complete list of notes on page 107.

Demonstration Boards and Evaluation Kits	
Part Number	Description
Connectivity Demonstration Kits (continued)	
AC163027-1	PICDEM™ Z Motherboard
AC163027-2	PICDEM™ Z 2.4 GHz RF Card
Mixed Signal Control Demonstration Kits	
AC163001	PICDEM™ MSC 1 Voltage Boost Demo Board; requires DM163012
AC163002	PICDEM™ MSC 1 High Power IR Demo Board; requires DM163012
AC163003	PICDEM™ MSC 1 Delta Sigma Demo Board; requires DM163012
AC163004	PICDEM™ MSC 1 Flow Rate Sensor Demo Board; requires DM163012
DM163012	PICDEM™ MSC 1 Mixed Signal Controller Demo Board for PIC16C781/782
dsPIC® Digital Signal Controller Demonstration Kits	
DM183021	PICDEM™ MC LV Development Board (uses 28L PIC18F2331/2431, dsPIC30F family)
DM240001**	Explorer 16 Demo Board
DM300004-1	dsPICDEM.net™ 1 FCC/JATE PSTN Support, Ethernet NIC Development Board
DM300004-2	dsPICDEM.net™ 2 CTR-21 PSTN Support, Ethernet NIC Development Board
DM300014	dsPICDEM™ 1.1 General Purpose Development Board
DM300016	dsPICDEM™ 64-Pin Starter Development Board
DM300017	dsPICDEM™ 28-Pin Starter Development Board
DM300018	dsPICDEM™ 2 Development Board
DM300019**	dsPICDEM 80-Pin Starter Development Board
DM300020	dsPICDEM™ MC1 Motor Control Development Board
DM300021	dsPICDEM™ MC1H 3-Phase High Voltage Power Module
DM300022	dsPICDEM™ MC1L 3-Phase Low Voltage Power Module
dsPIC® 16-bit DSC Software Tools	
SW300001	Digital Filter Design
SW300002	dsPIC® V.22/V.22bis Soft Modem Library (free download: www.microchip.com)
SW300003-EVAL	dsPIC® V.32 Soft Modem Library (Eval Copy)
SW300003, 04, 05	dsPIC® V.32 Soft Modem Library (5K, 25K, 100K licenses, respectively)
SW300006	dsPIC® V.22/V.22bis Soft Modem Library by Vocal Technology
SW300010-EVAL	dsPIC® Speech Recognition (Eval Copy)
SW300010, 11, 12	dsPIC® Speech Recognition (5K, 25K, 100K licenses, respectively)
SW300020	dsPIC30 Math Library: Double-Precision Floating Point Routines
SW300021	dsPIC30 Peripheral Library: Peripheral Initialization and Control Routines
SW300022	dsPIC30 DSP Library: Data Signal Processing Library Suite (FFT, Filters)
SW300023	dsPICworks™ Visual Algorithm Analyzer: Data Analyzer and Converter Tool
SW300030	dsPIC® CMX Scheduler: Multi-tasking, Preemptive Scheduler for dsPIC30F

NOTE: See complete list of notes on page 107.

Development Systems Products

Demonstration Boards and Evaluation Kits	
Part Number	Description
dsPIC® 16-bit DSC Software Tools (continued)	
SW300031	CMX-RTX for dsPIC® DSC: Fully Preemptive RTOS
SW300032	CMX-Tiny+ for dsPIC® DSC: Preemptive RTOS
SW300040-EVAL, 5K, 25K, 100K	dsPIC® Noise Suppression Library (Eval, 5K, 25K, 100K licenses, respectively)
SW300050-EVAL, 5K, 25K, 100K	dsPIC® Symmetric Embedded Encryption Library (Eval, 5K, 25K, 100K licenses, respectively)
SW300055-EVAL, 5K, 25K, 100K	dsPIC® Asymmetric Embedded Encryption Library (Eval, 5K, 25K, 100K licenses, respectively)
SW300060-EVAL, 5K, 25K, 100K	dsPIC® Acoustic Echo Cancellation Library (Eval, 5K, 25K, 100K licenses, respectively)
SW300070-EVAL, 5, 25, 100K*	dsPIC® Speech Coding/Decoding Library (Eval, 5K, 25K, 100K licenses, respectively)

NOTE: See complete list of notes on page 107.

PowerSmart® Systems	
Model Name/ Part Number	Description
PS042	PS401 PowerCal™ Board
PS051	PowerInfo™ 2 Configuration Interface Board for use with PS501, PS200, PS810
PS052	PowerCal™ 2 Configuration Interface Board for use with PS501, PS200, PS810
PS2070**	PS200 Configurable Battery Charger Evaluation Board
PS2070EV**	PS200 Configurable Battery Charger Evaluation Board with PS051 PowerInfo™ 2
PS5100	PS501 6-12 cell NiMH Module
PS5100EV	PS501 6-12 cell NiMH Module with PS051
PS5162	2-cell Li-Ion/Poly Fuel Gauge with safety
PS5162EV	2-cell Li-Ion/Poly Fuel Gauge with safety and PS051 PowerInfo™ 2
PS5163	3-cell Li-Ion/Poly Fuel Gauge with safety
PS5163EV	3-cell Li-Ion/Poly Fuel Gauge with safety and PS051 PowerInfo™ 2
PS5164	4-cell Li-Ion/Poly Fuel Gauge with safety
PS5164EV	4-cell Li-Ion/Poly Fuel Gauge with safety and PS051 PowerInfo™ 2
PS8070**	PS8X0 Li-Ion/Poly Single Cell Fuel Gauge
PS8070EV**	PS8X0 Li-Ion/Poly Single Cell Fuel Gauge with PS051 PowerInfo™ 2

NOTE: See complete list of notes on page 107.

Memory Evaluation/Developer's Kits		
SEEVAL® 32 Serial EEPROM Developer's Kit	DV243002	All serial EEPROMS, 24XX, 93XX, 25XX series

KEELOQ® Evaluation Kits										
	HCS101	HCS200/201	HCS300/301/320	HCS360/361	HCS362	HCS365/370	HCS410/412	HCS473	HCS500/515	HCS512
KEELOQ® Transponder Evaluation Kit*	–	–	–	–	–	–	DM303005	–	–	
KEELOQ® Evaluation Kit II*	DM303006	DM303006	DM303006	DM303006	DM303006	DM303006	DM303006	DM303006	DM303006	
PRO MATE® II Universal Programmer for SOIC*	AC004002	AC004002	AC004002	AC004002	AC004002	AC004003	AC004002	AC004003	–	AC164002
PRO MATE® II Universal Programmer for DIP*	AC004001	AC004001	AC004001	AC004001	AC004001	AC004007	AC004001	AC004007	–	AC164001
PRO MATE® II Universal Programmer for ICSP™*	AC004004	AC004004	AC004004	AC004004	AC004004	AC004004	AC004004	AC004004	AC004004	

* Support is limited to PRO MATE® II using MPLAB® IDE release 5.70.

RFID Evaluation/Developer's Kits		
	MCRF355	MCRF450/452
13.56 MHz Anti-Collision microID® Developer's Kits	DV103003, DV103006	DV103006
microID® Programmer Kit only for MCRF355	PG103003	–

Analog/Interface Demo/Eval/Developer's Kits		
Interface	Part Number	Devices Supported
MCP2140 IrDA® Wireless Temp. Demo	MCP2140DM-TMPSNS	MCP2140
MCP215X Data Logger Demo Board	MCP215XDM	MCP2150/55
MCP250XX CAN I/O Expanders Developer's Kit	DV250501	MCP25020, MCP25025, MCP25050, MCP25055
MCP2510/2515 CAN Developer's Kit	DV251001	MCP2510, MCP2515
MCP2120/2150 Developer's Kit	DM163008	MCP2120, MCP2150
MCP23X08 Evaluation Board	MCP23X08EV	MCP23008, MCP23S08
MCP23X17 Evaluation Board	MCP23X17EV	MCP23017, MCP23S17
Linear	Part Number	Devices Supported
MCP6S22 PGA PICtail™ Demo Board	MCP6S22DM-PICTL	MCP6S22/92
MCP6SX2 PGA Photodiode PICtail™ Demo Board	MCP6SX2DM-PCTLPD	MCP6S22/92
MCP6SX2 PGA Thermistor PICtail™ Demo Board	MCP6SX2DM-PCTLTH	MCP6S22/92
MCP6S2X PGA Evaluation Board	MCP6S2XEV	MCP6S2X
Mixed Signal	Part Number	Devices Supported
Mixed Signal PICtail™ Demo Board	MXSIGDM	TX132X, MCP330X, MCP320X, MCP494X, MCP3221, MCP3201, MCP1525, MCP1541
Evaluation Kit for Sigma-Delta A/D Converter Family	TX3400EV	TX3400X
Single-Dual A/D	DV3201A	MCP3001, MCP3002, MCP3201, MCP3202
MCP3201/02 Evaluation System Daughter Board	DV3201A	MCP3201/02
MXDEV Analog Evaluation System	DVMCPA	MCP3001/02, MCP3004/08, MCP3201/02, MCP3204/08
MCP3204/08 Evaluation System Daughter Board	DV3204A	MCP3204, MCP3208
MCP42XXX Digital Pot Evaluation Kit	DV42XXX	MCP42010, MCP42050, MCP42100
MCP402X Evaluation Board	MCP402XEV	MCP4021, MCP4022, MCP4023, MCP4024

**Development
Systems Products**

Analog/Interface Demo/Eval/Developer's Kits		
Power Management	Part Number	Devices Supported
MCP1612 Synchronous Buck Regulator Evaluation Board	MCP1612EV	MCP1612
MCP1630 +12V Dual Output Buck Converter Ref. Design	MCP1630RD-DDBK1	MCP1630
MCP1630 Li-Ion Multi Bay Battery Charger Ref. Design	MCP1630RD-LIC1	MCP1630
MCP1630 NiMH Battery Charger Demo Board	MCP1630DM-NMC1	MCP1630
MCP1601 Buck Regulator Evaluation Board	MCP1601EV	MCP1601
Voltage Supervisor Evaluation Board	VSUPEV	SOT-23 packages
MCP7386X Li-Ion Battery Charger Evaluation Board	MCP7386XEV	MCP73861/62
MCP165X 3W White LED Demo Board	MCP1650DM-LED1	MCP1650/51
MCP1650 Boost Controller Evaluation Board	MCP1650EV	MCP1650
MCP7384X Li-Ion Battery Charger	MCP7384XEV	MCP7384X
MCP7382X Li-Ion Battery Charger	MCP7382XEV	MCP7382X
MCP73855 Evaluation Board	MCP73855EV	MCP73855
Voltage Supervisor SOT23-5/6 Evaluation Board	VSUPEV2	SOT23-5/6-lead packages
MCP1726 Evaluation Board	MCP1726EV	MCP1726
Thermal Management Tools	Part Number	Devices Supported
MCP9800 Thermal Sensor PICtail™ Demo Board	MCP9800DM-PCTL	MCP9800
Demo Board for Tiny Serial Digital Thermal Sensor	TC74DEMO	TC74
Fan Controller Demo Board for TC652	TC652DEMO	TC652
Fan Controller Demo Board for TC650	TC650DEMO	TC650
Evaluation Kit for the Fan Speed Controllers	TC642EV	TC642, TC646, TC647, TC648, TC649, TC642B, TC646B, TC647B, TC648B, TC649B
TC72 Digital Temperature Sensor	TC72DM-PICTL	TC72
TC77 Thermal Sensor PICtail™ Demo	TC77DM-PICTL	TC77
Demo Board for Fan Speed Controllers	TC642DEMO	TC642
TC1047A Temperature to Voltage	TC1047ADM-PICTL	TC1047A

PIN AND CODE COMPATIBILITY CHART

8-pin PICmicro® MCU Family

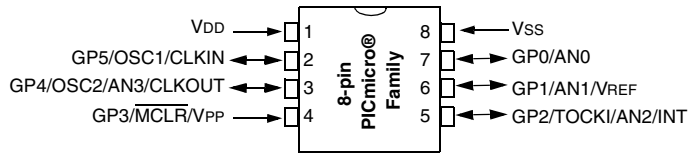

PIC12C508A	PIC12C671	PIC12F510
PIC12C509A	PIC12C672	PIC12F629
PIC12CR509A	PIC12CE673	PIC12F635
PIC12CE518	PIC12CE674	PIC12F675
PIC12CE519	PIC12F508	PIC12F683
	PIC12F509	

8-pin KEELoq® Family

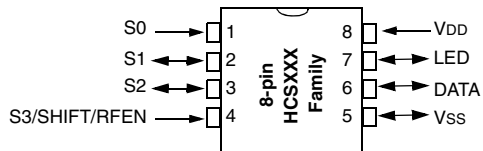

HCS101	HCS300	HCS360
HCS200	HCS301	HCS361
HCS201	HCS320	HCS362
		HCS365

8/14/20-pin PICmicro® MCU Family

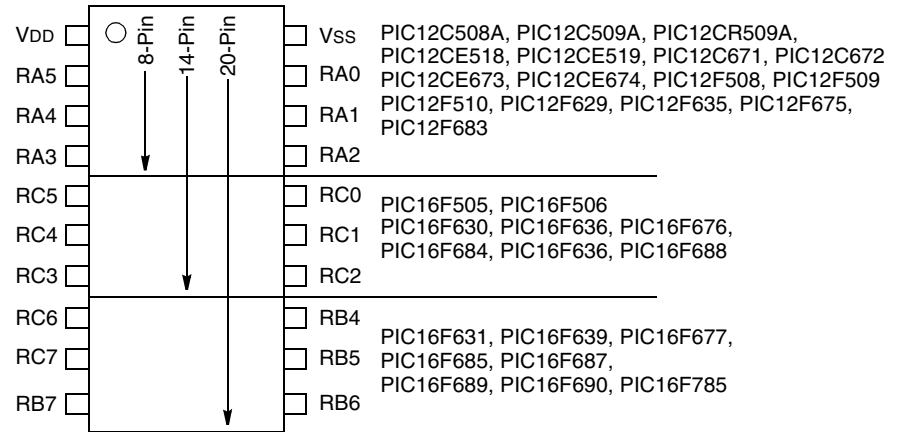

14-pin PICmicro® MCU Family

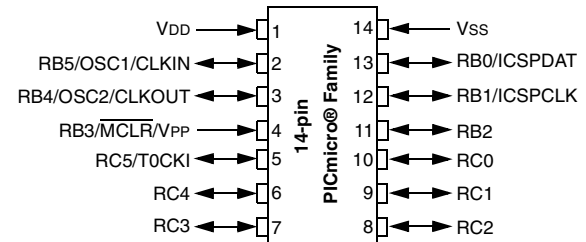

PIC16F505	PIC16F630	PIC16F688
PIC16F506	PIC16F636	PIC16F684
	PIC16F676	

18-pin PICmicro® MCU Family

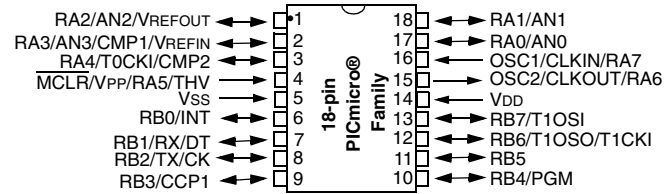

PIC16C620A	PIC16CE625	PIC16C711	PIC16F819
PIC16CR620A	PIC16F627	PIC16C712	PIC16F87
PIC16C621A	PIC16F628	PIC16C715	PIC16F88
PIC16C622A	PIC16F627A	PIC16C716	PIC16F54
PIC16CE623	PIC16F628A	PIC16F716	PIC16HV540
PIC16CE624	PIC16F648A	PIC16C58B	PIC18F1220
PIC16C54C	PIC16C56A	PIC16F84A	PIC18F1320
	PIC16C710	PIC16F818	

20-pin PICmicro® MCU Family

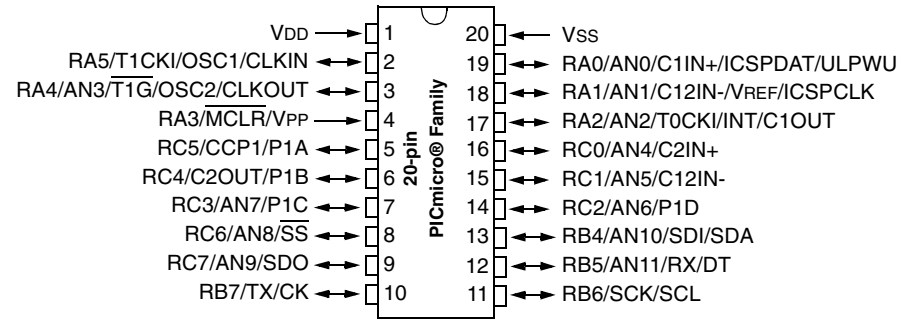

PIC16F685	PIC16F689
PIC16F687	PIC16F690

28-pin PICmicro® MCU Family

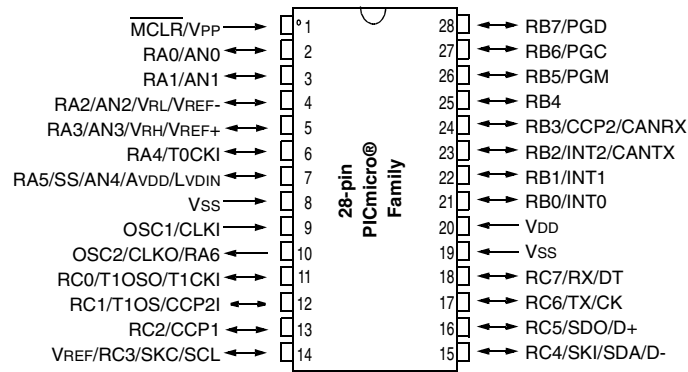

PIC16C62B	PIC16F767*	PIC18F2331
PIC16CR63	PIC16F870*	PIC18F2410
PIC16C63A	PIC16F872*	PIC18F2420
PIC16C642	PIC16F873*	PIC18F2431
PIC16C66	PIC16F873A*	PIC18F2455
PIC16CR72	PIC16F876*	PIC18F2480
PIC16C72A	PIC16F876A*	PIC18F2510
PIC16C73B	PIC16F913*	PIC18F2515
PIC16C745	PIC18C242	PIC18F2520
PIC16C76	PIC18C252	PIC18F2525
PIC16C773	PIC18F242	PIC18F2550
PIC16F57	PIC18F248	PIC18F2580
PIC16F72*	PIC18F252	PIC18F2585
PIC16F73*	PIC18F258	PIC18F2610
PIC16F737*	PIC18F2220	PIC18F2620
PIC16F76*	PIC18F2221	PIC18F2680
	PIC18F2320	
	PIC18F2321	

* PGM for PIC16FXXX devices is located on pin 24.

40-pin PICmicro® MCU Family

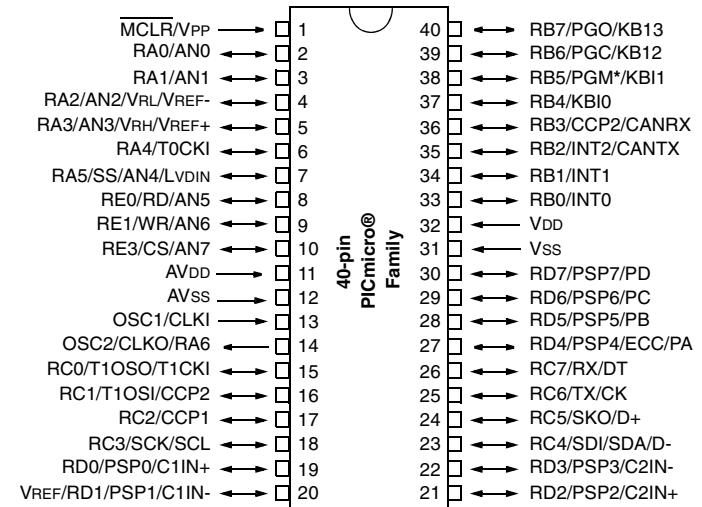

PIC16CR65	PIC16F874A*	PIC18F4331
PIC16C65B	PIC16F877*	PIC18F4410
PIC16C662	PIC16F877A*	PIC18F4420
PIC16C67	PIC16F914*	PIC18F4431
PIC16C74B	PIC16F917*	PIC18F4455
PIC16C765	PIC18C442	PIC18F4480
PIC16C77	PIC18C452	PIC18F4510
PIC16C774	PIC18F442	PIC18F4515
PIC16F59	PIC18F448	PIC18F4520
PIC16F74*	PIC18F452	PIC18F4525
PIC16F747*	PIC18F458	PIC18F4550
PIC16F77*	PIC18F4220	PIC18F4580
PIC16F777*	PIC18F4221	PIC18F4585
PIC16F871*	PIC18F4320	PIC18F4610
PIC16F874*	PIC18F4321	PIC18F4620
		PIC18F4680

* PGM for PIC16FXXX devices is located on pin 36.

64-pin PICmicro® MCU Family

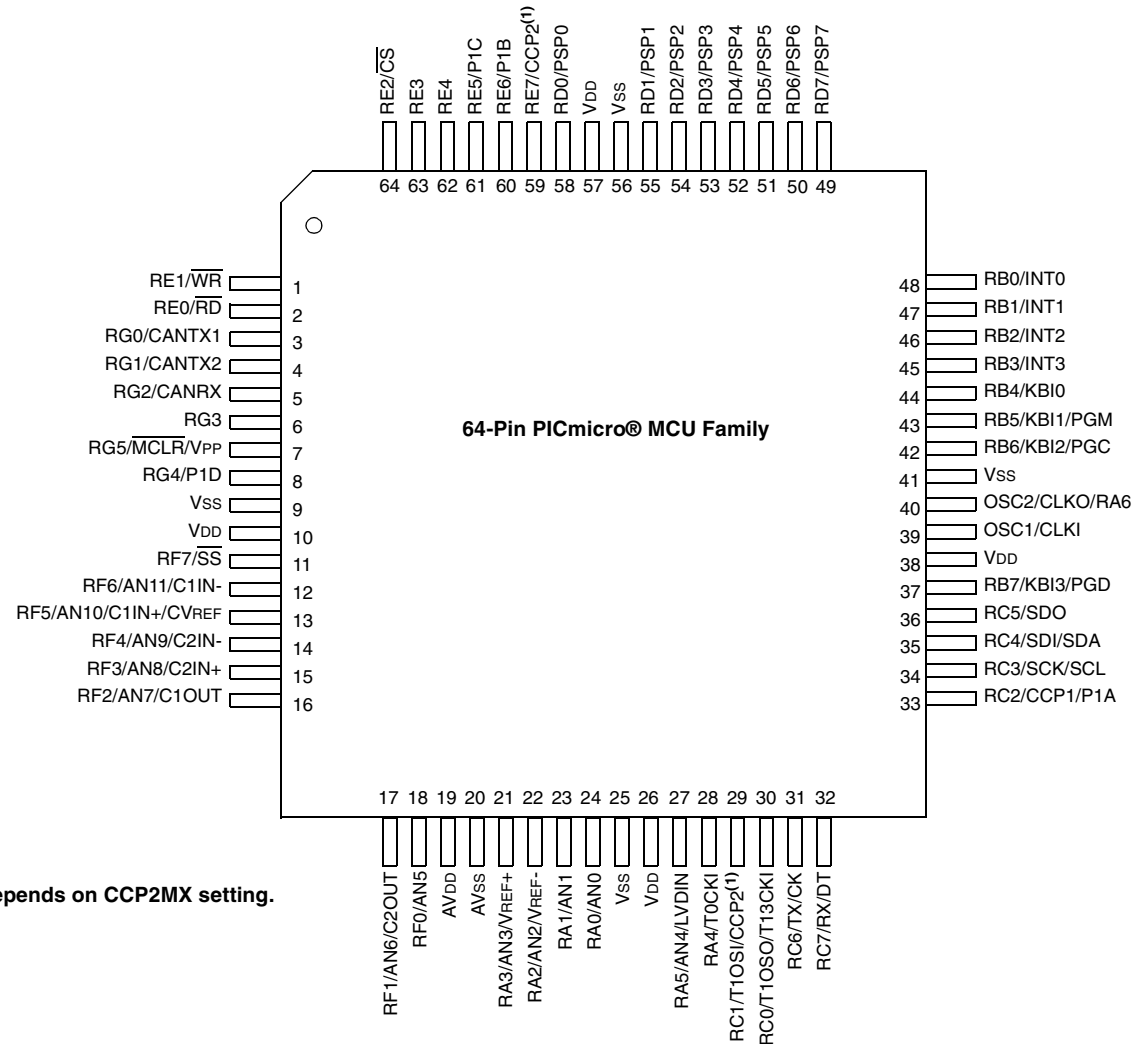

Note 1: CCP2 pin placement depends on CCP2MX setting.

PIC18F6310	PIC18F6522	PIC18F6621
PIC18F6390	PIC18F6525	PIC18F6627
PIC18F6410	PIC18F6527	PIC18F6680
PIC18F6490	PIC18F6585	PIC18F6720
PIC18F6520	PIC18F6620	PIC18F6722
	PIC18F6622	

80-pin PICmicro® MCU Family

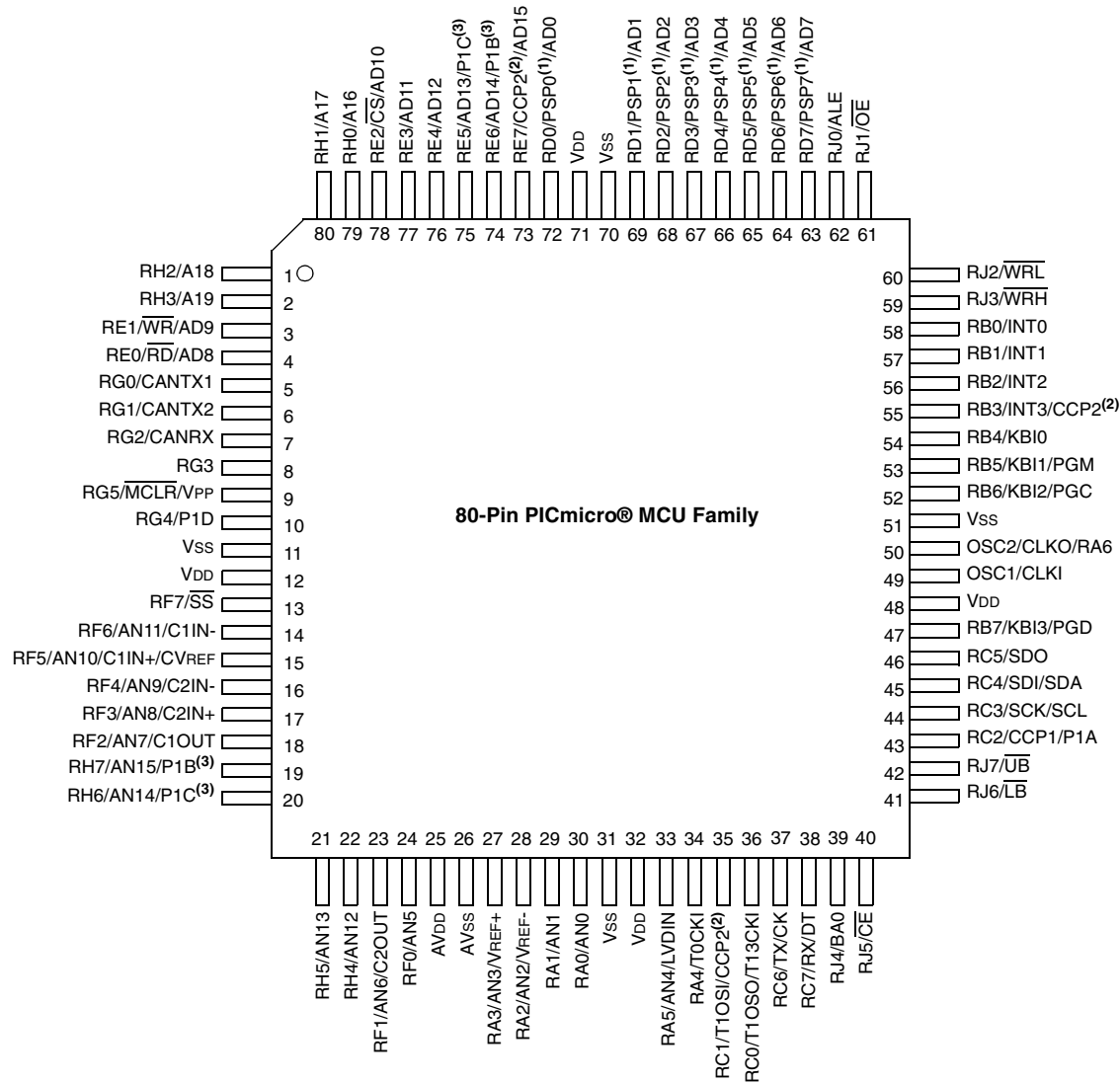

Note 1: PSP is available only in Microcontroller mode.

Note 2: CCP2 pin placement depends on CCP2MX and Processor mode settings.

Note 3: P1B and P1C pin placement depends on ECCPMX setting.

PIC18F8310	PIC18F8585
PIC18F8390	PIC18F8620
PIC18F8410	PIC18F8621
PIC18F8490	PIC18F8622
PIC18F8520	PIC18F8680
PIC18F8522	PIC18F8720
PIC18F8525	PIC18F8722
PIC18F8527	

**Pin Count
Packaging**



18-LEAD CERDIP
"JW"



20-LEAD CERDIP
"JW"



28-LEAD CERDIP
"JW"

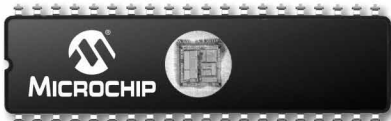

40-LEAD CERDIP
"JW"

**CERAMIC CHIP CARRIER
CERQUAD**



68-LEAD CERQUAD
"CL"

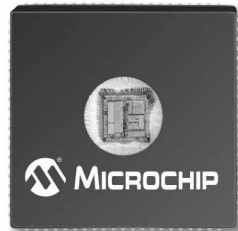

84-LEAD CERQUAD
"CL"



8-LEAD PDIP
"P" OR "PA"



14-LEAD PDIP
"P" OR "PD"



18-LEAD PDIP
"P"



20-LEAD PDIP
"P"



24-LEAD PDIP
"P" OR "PG"



28-LEAD PDIP
"P" OR "PI"



28-LEAD SKINNY PDIP
"SP" OR "PJ"



40-LEAD PDIP
"P" OR "PL"

**PLASTIC QUAD
FLATPACK
"QFP"**



32-LEAD LQFP
"LQ"



44-LEAD MQFP
"PQ"



32-LEAD PLCC
"L"



44-LEAD PLCC
"L" OR "W"



68-LEAD PLCC
"L" OR "LS"



84-LEAD PLCC
"L"

PACKAGES ARE APPROXIMATE SIZE

PLASTIC SMALL OUTLINE "SOIC"

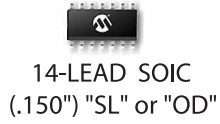
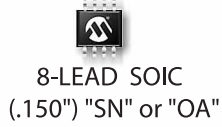

PLASTIC SHRINK
SMALL OUTLINE "SSOP"



PLASTIC THIN QUAD
FLATPACK "TQFP"

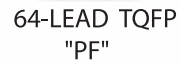
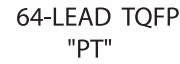

SIDE BRAZED
DUAL IN-LINE "TQFP"



PACKAGES ARE APPROXIMATE SIZE

PLASTIC THIN SHRINK
SMALL OUTLINE



8-LEAD TSSOP
(4.4 MM) "ST"



14-LEAD TSSOP
(4.4 MM) "ST" (PICmicro® MCU)
(4.4 MM) "ST14" (Memory)



20-LEAD TSSOP
(4.4 MM) "ST"

CHIP SCALE PACKAGES



8-LEAD DFN
2x3 "MC"



8-LEAD DFN
3x3 "MF"



8-LEAD DFN
6x5 "MF"



28-LEAD QFN
6x6 "ML" or "MM"



8-LEAD DFN
4x4 "MD"



16-LEAD QFN
4x4 "ML"



20-LEAD QFN
4x4 "ML"



44-LEAD QFN
8x8 "ML"



3-LEAD DDPACK



5-LEAD DDPACK

SMALL OUTLINE TRANSISTORS



3-LEAD TRANSISTOR
"TO" or "ZB"



3-LEAD SC-89



SOT-223



6-LEAD SOT-23
"CH" or "OT"



3-LEAD SOT-23
"TT" or "CB"



SOT-143
"RC"



5-LEAD TO-220



5-LEAD SOT-23
"OT" or "CT"



5-LEAD SC-70
"LT"



3-LEAD SC-70
"LB"

PACKAGES ARE APPROXIMATE SIZE

Part Number Suffix Designations

Ordering Information for all Microchip PICmicro®, KEELoq®, RFID, rHCS and Memory Products

XXXXXXXXXX - XX X/XX XXX

<p>QTP, SQTP or ROM Code; Special Requirements</p>	
<p>Package:</p>	
CB = Chip on Board (COB)	S = Die in Waffle Pack
CL = Windowed CERQUAD	SL = 14-lead Small Outline (150 mil)
G = Lead Free	SM = 8-lead Small Outline (207 mil)
JW = Windowed CERDIP	SN = 8-lead Small Outline (150 mil)
L = Plastic Leaded Chip Carrier (PLCC)	SO = Plastic Small Outline (SOIC) (300 mil)
LQ = Plastic Low Quad Flatpack (LQFP)	SP = Plastic Skinny DIP
MC = Dual Flat-No Leads (DFN) 2x3 mm	SS = Plastic Shrink Small Outline (SSOP)
MF = Dual Flat - No Leads (DFN) 5x6 mm	ST = Thin Shrink Small Outline (TSSOP 4.4 mm)
ML = Quad Flat - No Leads (QFN)	ST14 = 14-lead Thin Shrink Small Outline (TSSOP-14)
MM = Quad Flat - No Leads (DFN)	TO-92 = Transistor Outline
MS = Micro Small Outline (MSOP)	TS = Thin Small Outline (8mm x 20mm)
OT = 5-Lead or 6-Lead SOT-23	TT = SOT-23-3 Small Outline Transistor
P = Plastic DIP	VS = Very Small Outline (8mm x 12mm)
PF = Plastic Thin Quad Flatpack (TQFP 14x14)	W = Uncut Wafer
PQ = Plastic Quad Flatpack (PQFP)	WF = Sawed Wafer on Frame
PT = Plastic Thin Quad Flatpack (TQFP)	WM = SOT385 Leadless Module
<p>Process Temperature:</p>	
Blank = 0°C to +70°C	
I (Industrial) = -40°C to +85°C	
E (Extended) = -40°C to +125°C	
<p>Speed: OR</p>	
-90 = 90 ns	
-10 = 100 ns	
-12 = 120 ns	
-15 = 150 ns	
-17 = 170 ns	
-20 = 200 ns or 20 MIPS	
-25 = 250 ns or 30 MIPS	
-30 = 300 ns	
<p>Option:</p>	
T = Tape and Reel Shipments	
X = Rotated pinout	
<p>Device Type: (Up to 10 digits)</p>	
AA = 1.8V Serial EEPROM	LCE = Low Voltage CMOS EPROM/EEPROM MCU
C = CMOS EPROM/ROMless MCU	LCR = Low Voltage CMOS ROM MCU
C = 5V Serial EEPROM	LCS = Low Voltage Security
CE = CMOS EPROM/EEPROM MCU	LF = Low Voltage FLASH MCU
CR = CMOS ROM MCU	LV = Low Voltage
F = Flash MCU	R = CMOS ROM MCU (PIC18)
FC = High Speed serial EEPROM	24 = 2-Wire (I ² C)
HC = High Speed	25 = SPI
HV = High Voltage	93 = 3-Wire (Microwire)
LC = Low Voltage CMOS EPROM MCU	
LC = Low Voltage (2.5V) Serial EEPROM	
<p>Crystal Frequency Designator for PICmicro® MCUs</p>	
LP = DC to 40 kHz, Low-Power Crystal Oscillator	
RC = DC to 4 MHz, Resistor/Capacitor Oscillator	
XT = DC to 4 MHz, Standard Crystal Resonator Oscillator	
HS = DC to 20 MHz, High Speed Crystal Oscillator	
02 = DC to 2 MHz, XT and RC Oscillator Support	
04 = DC to 4 MHz Internal, XT and RC Oscillator Support	
04 = DC to 200 kHz, LP Oscillator Support	
08 = DC to 8 MHz, HS Oscillator Support	
10 = DC to 10 MHz, HS Oscillator Support	
16 = DC to 16 MHz, XT Oscillator Support	
20 = DC to 20 MHz, HS Oscillator Support	
25 = DC to 25 MHz, XT Oscillator Support	
30 = DC to 30 MHz, HS Oscillator Support	
33 = DC to 33 MHz, XT Oscillator Support	
40 = DC to 40 MHz, HS Oscillator Support	

Note: Microchip offers a wide variety of lead-free package options. Contact your local sales office for availability or refer to the list on Microchip's web site.

Product Information System

Ordering Information for all Microchip Analog Products beginning with "TC" (formerly TelCom Semiconductor Products)

TC 7106 A-60 1 C P L 713

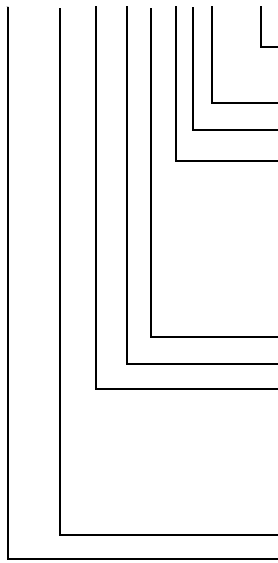

Taping Direction:

TR or 713: Standard Taping, blank: no tape and reel

Number of Package Pins (See specific data sheet)

Package Type

Operating Temperature Range:

C: Commercial Range (0°C to +70°C)

E: Extended Industrial Range (-40°C to +85°C)

I: Industrial Range (-25°C to +85°C)

M: Military Range (-55°C to +125°C)

V: See Data Sheet for Specific Temperature Range

(Extra Feature Code and/or Tolerance)* (See specific data sheet)

(Output Voltage or Detect Voltage)* (If applicable, see specific data sheet)

Electrical Performance Grade Option (Variation/Option)* (If applicable, see specific data sheet)

A: Test Selection Criteria (See specific data sheet)

B:

R: Reversed Pin Layout

Product Part Number (2 to 6 characters, see specific data sheet)

Product Prefix

NOTE: (*) Used for voltage regulators and detectors.

Package	Description	# of Pins
AB	TO-220	3
AK	TO-220	7
AT	TO-220	5
AV	TO-220 (Formed)	5
BB	TO-220B	3
CB	SOT-23A	3
CH	SOT-23A	6
CT	SOT-23A	5
DB	SOT-223	3
EB	DDPAK	3
EK	DDPAK	7
ET	DDPAK	5
HA	SOP	8
JA	CDIP (N)	8
JD	CDIP (N)	14
JE	CDIP (N)	16
JG	CDIP (W)	24
JI	CDIP (W)	28
JL	CDIP (W)	40
KU	MQFP	64
KW	MQFP	44
LB	SC-70	3
LI	PLCC	28
LS	PLCC	68
LT	SC-70	5
LW	PLCC	44

Package	Description	# of Pins
MB	SOT-89	3
MF	DFN (3x3)	8
MT	SOT-89	5
NB	SOT-23B	3
OA	SOIC (N)	8
OD	SOIC (N)	14
OE	SOIC (W)	16
OG	SOIC (W)	24
OI	SOIC (W)	28
OR	SOIC (N)	16
PA	PDIP (N)	8
PD	PDIP (N)	14
PE	PDIP (N)	16
PF	PDIP (N)	24
PG	PDIP (W)	24
PI	PDIP (W)	28
PJ	PDIP (W)	28
PL	PDIP (W)	40
QR	QSOP (N)	16
RC	SOT-143	4
SI	SSOP (W)	28
UA	MSOP	8
UN	MSOP	10
VB	DDPAK	3
ZB	TO-92	3
ZM	TO-92	2

Part Number Suffix Designations

Ordering Information for all Microchip Analog Products beginning with "MCP" Prefix Parts

MCP xxxxx T - yyy z h / qq

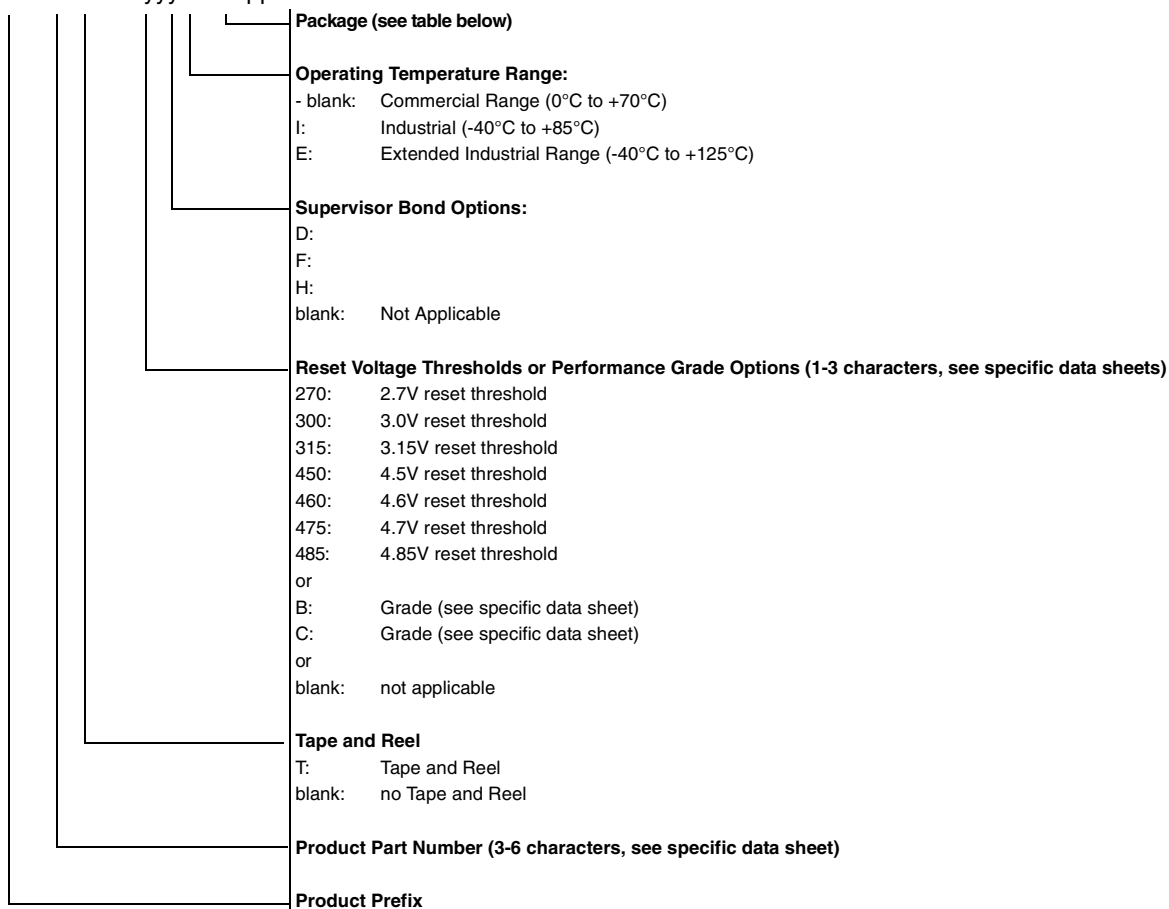

Product Information System

Package	Description	# of Pins	Tube/Bag Qty.	Reel Qty.
TO	TO-92	3	1000	n/a
TT	SOT-23	3	n/a	3000
OT	SOT-23	5	n/a	3000
P	PDIP	8	60	n/a
SN	SOIC	8	100	3300
ST	TSSOP	8	100	2500
MS	MSOP	8	100	2500
MF	DFN (2x3)	8	n/a	3300
MF	DFN (3x3)	8	50	3300
MF	DFN (3x3, 10-Pin)	10	120	3300
ST	TSSOP	14	96	2500
P	PDIP	14	30	n/a
SL	SOIC	14	57	2600
P	PDIP	18	25	n/a
SO	SOIC	18	42	1100
ST	TSSOP	20	74	2500
SS	SSOP	20	67	1600
ML	QFN (6x6)	28	50	1600
ML	QFN (4x4)	16	91	3300

ABBREVIATIONS

ADC	Analog-to-Digital Converter
ASK	Amplitude Shift Key
AUSART	Addressable USART (RS-232, RS-485)
BOR	Brown-Out Detection/Reset
CAN	Controller Area Network
CAP	Capture
CCP	Capture/Compare/1 PWM output
CRC	Cyclic Redundancy Check
DAC	Digital-to-Analog Converter
DMA	Direct Memory Access
3 ϕ	3 Phase PWMs
4 ϕ	4 Phase PWMs
E2	EEPROM (Reprogrammable)
ECAN	Enhanced Controller Area Network
ECCP	Enhanced Capture/Compare/4 PWM outputs with program dead time
EMA	External Memory Addressing
EnhFI	Enhanced Flash: 100K erase/write cycles, 40 year retention, self-programmable in socket from 2V to 5.5V, ICSP at 5V or 12V
EUSART	Enhanced USART (RS232, RS485, LIN)
FSK	Frequency Shift Key
I ² C™	Inter-integrated Circuit Bus
ICSP™	In-Circuit Serial Programming™
ICD	# of In-Circuit Debug Breakpoints
IntOSC	Internal Oscillator
JTAG	Joint Test Action Group
LNA	Low Noise Amplifier
LVD	Low Voltage Detection
LIN XCVR	Local Interconnection Network Transceiver
MI ² C/SPI	Master I ² C/SPI
nW	nanoWatt
OTP	One-Time Programmable
PBOR	Programmable Brown-Out Detection/Reset
PLVD	Programmable Low-Voltage Detection
PMP	Parallel Master Port
PSMC	Programmable Switch Mode Controller
PSP	Parallel Slave Port
PSMC	Programmable Switch Mode Controller
PWM	Pulse Width Modulator
ROM-less	External ROM necessary
RSSI	Received Signal Strength Indicator
RTCC	Real Time Clock with Calendar
SLAC	Slope A/D Converter, up to 16 bits
SMB	System Management Bus
SPI™	Serial Peripheral Interface
StdFI	Standard Flash: up to 10,000 erase/write cycles, 40 year retention, ICSP capability at 12V
ULPW	Ultra Low Power Wake-up
USART	Universal Synchronous/Asynchronous Receiver/Transmitter
USB	Universal Serial Bus
V _{REF}	Voltage Reference
WDT	Watchdog Timer
WUR	Wake-up Reset
✓P	Programmable
x12	12-bit Instruction Width
x14	14-bit Instruction Width
x16	16-bit Instruction Width

Microchip Technology's Quality Policy

In order to meet or exceed customer expectations at a reduced cost, we encourage our employees to support continuous improvement, anticipate problems and implement root cause solutions.

Aggregate Approach

Microchip has instituted an "aggregate" approach to understand, align, integrate and unite all company resources. Microchip consciously designed the enterprise as an aggregate system in which company culture, systems, practices, policies and employees work in unison to achieve Microchip's mission and goals. This aggregate system and culture is taught in the Microchip Culture class required for all new hires and taught by Executive Staff members.

The Quality Culture of Microchip is that every organization, business unit and individual owns the quality of their output, whether it is product, process, software or service.

A company must aggressively pursue continuous improvement, employee development, team deployment and statistical techniques to successfully achieve individual accountability of quality.

Continuous Improvement

Microchip promotes a culture of continuous improvement. As stated above, each employee is measured on how they contribute to improvement. Continuous improvement teams are constantly looking to solve problems, allowing us to maximize our value to our customers.

Employee Development and Team Deployment

Every employee has access to a full suite of training. Each employee is measured on Quality and Quantity of work, Teamwork, Continuous Improvement and Customer Satisfaction. Supervisors are measured on how their employees improve and learn. Employees have regular One-on-Ones with their supervisors and open door is a policy that is really practiced.

Statistical Techniques

Microchip uses statistical process techniques in all aspects of our business. Decision-making, experiment definition and process control are a few areas where these techniques are applied. Every manufacturing employee is trained in SPC before they start their job, since they are the people closest to the product quality.

QS-9000 Certification

Microchip Technology's Quality System is based on QS-9000 requirements. QS-9000 is rapidly becoming the standard Quality System for many industries including Semiconductors. All Microchip product facilities and major subcontractors are QS registered. Development Systems and Mountain View products are designed, manufactured and certified to ISO-9001 requirements.

Quality Systems and Reliability Information

Visit www.microchip.com for detailed Quality Systems and Reliability information.

Microchip's Quality System is fully described in the *Microchip Overview, Quality Systems and Customer Interface Systems Handbook* (DS00169) available on our web site.

AMERICAS

Atlanta	770-640-0034
Boston	774-760-0087
Chicago	630-285-0071
Dallas	972-818-7423
Detroit	248-538-2250
Kokomo	765-864-8360
Los Angeles	949-462-9523
San Jose	650-215-1444
Toronto	905-673-0699

ASIA/PACIFIC

Australia – Sydney	61-2-9868-6733
China – Beijing	86-10-8528-2100
China – Chengdu	86-28-8676-6200
China – Fuzhou	86-591-8750-3506
China – Hong Kong	852-2401-1200
China – Qingdao	86-532-8502-7355
China – Shanghai	86-21-5407-5533
China – Shenyang	86-24-2334-2829
China – Shenzhen	86-755-8203-2660
China – Shunde	86-757-2839-5507
China – Wuhan	86-27-5980-5300
China – Xian	86-29-8833-7250
India – Bangalore	91-80-2229-0061
India – New Delhi	91-11-5160-8631
India – Pune	91-20-2566-1512
Japan	81-45-471-6166
Korea – Gumi	82-54-473-4301
Korea – Seoul	82-2-554-7200
Malaysia	604-646-8870
Phillippines	632-634-9065
Singapore	65-6334-8870
Taiwan – Hsinchu	886-3-572-9526
Taiwan – Kaohsiung	886-7-536-4818
Taiwan – Taipei	886-2-2500-6610
Thailand – Bangkok	66-2-694-1351

EUROPE

Austria	43-7242-2244-399
Denmark	45-4450-2828
France	33-1-69-53-63-20
Germany	49-89-627-144-0
Italy	39-0331-742611
Netherlands	31-416-690399
Spain	34-91-708-08-90
United Kingdom	44-118-921-5869



MICROCHIP
www.microchip.com

2355 West Chandler Boulevard • Chandler, Arizona 85224-6199 • (480) 792-7200 • Fax (480) 792-7277

Information subject to change. The Microchip name and logo, the Microchip logo, Accuron, dsPIC, Keeloq, microID, MPLAB, PIC, PICmicro, PICSTART, PRO MATE, PowerSmart, rPIC, and SmartShunt are registered trademarks of Microchip Technology Incorporated in the U.S.A. and other countries. AmpLab, FilterLab, Migratable Memory, MXDEV, MXLAB, PICMASTER, SEEVAL, SmartSensor and The Embedded Control Solutions are registered trademarks of Microchip Technology Incorporated in the U.S.A. Analog-for-the-Digital Age, Application Maestro, dsPICDEM, dsPICDEM.net, dsPICworks, ECAN, ECONOMONITOR, FanSense, FlexROM, fuzzyLAB, In-Circuit Serial Programming, ICS9ICEPIC, Linear Active Thermistor, MPASM, MPLIB, MPLINK, MPSIM, PICkit, PICDEM, PICDEM.net, PICLAB, PICTail, PowerCal, PowerInfo, PowerMate, PowerTool, Real ICE, rLab, Select Mode, Smart Serial, SmartTel, Total Endurance, UNI/O, WiperLock and Zena are trademarks of Microchip Technology Incorporated in the U.S.A. and other countries. SQTP is a service mark of Microchip Technology Incorporated in the U.S.A.

All other trademarks mentioned herein are property of their respective companies.

©2006 Microchip Technology Inc. All rights reserved. Printed in the U.S.A. 1/06 DS00148L1



Стандарт Электрон Связь

Мы молодая и активно развивающаяся компания в области поставок электронных компонентов. Мы поставляем электронные компоненты отечественного и импортного производства напрямую от производителей и с крупнейших складов мира.

Благодаря сотрудничеству с мировыми поставщиками мы осуществляем комплексные и плановые поставки широчайшего спектра электронных компонентов.

Собственная эффективная логистика и склад в обеспечивает надежную поставку продукции в точно указанные сроки по всей России.

Мы осуществляем техническую поддержку нашим клиентам и предпродажную проверку качества продукции. На все поставляемые продукты мы предоставляем гарантию .

Осуществляем поставки продукции под контролем ВП МО РФ на предприятия военно-промышленного комплекса России , а также работаем в рамках 275 ФЗ с открытием отдельных счетов в уполномоченном банке. Система менеджмента качества компании соответствует требованиям ГОСТ ISO 9001.

Минимальные сроки поставки, гибкие цены, неограниченный ассортимент и индивидуальный подход к клиентам являются основой для выстраивания долгосрочного и эффективного сотрудничества с предприятиями радиоэлектронной промышленности, предприятиями ВПК и научно-исследовательскими институтами России.

С нами вы становитесь еще успешнее!

Наши контакты:

Телефон: +7 812 627 14 35

Электронная почта: sales@st-electron.ru

Адрес: 198099, Санкт-Петербург,
Промышленная ул, дом № 19, литера Н,
помещение 100-Н Офис 331