

## TRIACs, 20A Snubberless

### FEATURES

- Medium current triac
- Low thermal resistance with clip bonding
- Low thermal resistance insulation ceramic for insulated TO-220AB & TO-3P package
- Clip assembly
- 20T series are **UL** certified (File ref: E320098)
- Packages are RoHS compliant

### APPLICATIONS

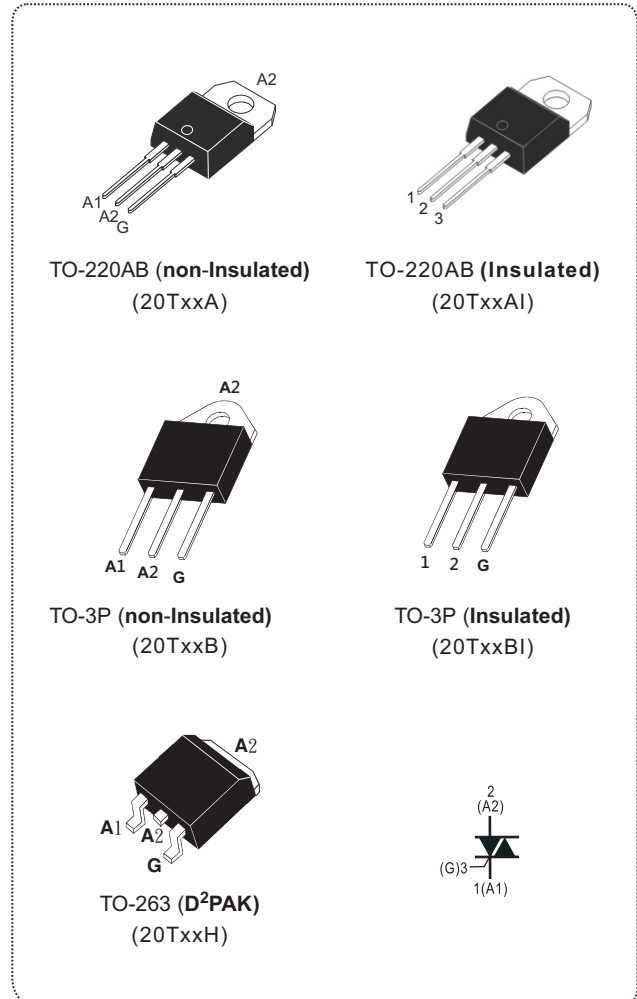
The snubberless concept offer suppression of RC network and it is suitable for applications such as phase control and static switching on inductive or resistive load.

Due to their clip assembly technique, they provide a superior performance in surge current handling capabilities.

By using an internal ceramic pad, the 20T series provides voltage insulated tab (rated at 2500VRMS) complying with UL standards.

### MAIN FEATURES

SYMBOL	VALUE	UNIT
$I_{T(RMS)}$	20	A
$V_{DRM}/V_{RRM}$	600 to 1000	V
$I_{GT(Q1)}$	35 to 50	mA



ABSOLUTE MAXIMUM RATINGS					
PARAMETER	SYMBOL	TEST CONDITIONS		VALUE	UNIT
RMS on-state current (full sine wave)	$I_{T(RMS)}$	TO-263/TO-220AB/TO-3P	$T_c = 90^\circ\text{C}$	20	A
		TO-220AB insulated/TO-3P insulated	$T_c = 70^\circ\text{C}$		
Non repetitive surge peak on-state current (full cycle, $T_j$ initial = $25^\circ\text{C}$ )	$I_{TSM}$	F = 50 Hz	t = 20 ms	200	A
		F = 60 Hz	t = 16.7 ms		
$I^2t$ Value for fusing	$I^2t$	$t_p = 10$ ms		200	$\text{A}^2\text{s}$
Critical rate of rise of on-state current $I_G = 2xI_{GT}$ , $t_r \leq 100\text{ns}$	dI/dt	F = 100 Hz	$T_j = 125^\circ\text{C}$	50	$\text{A}/\mu\text{s}$
Peak gate current	$I_{GM}$	$T_p = 20 \mu\text{s}$	$T_j = 125^\circ\text{C}$	4	A
Peak gate power dissipation ( $t_p = 20\mu\text{s}$ )	$P_{GM}$	$T_j = 125^\circ\text{C}$		10	W
Average gate power dissipation	$P_{G(AV)}$	$T_j = 125^\circ\text{C}$		1	
Storage temperature range	$T_{stg}$			- 40 to + 150	°C
Operating junction temperature range	$T_j$			- 40 to + 125	

⊙ ELECTRICAL CHARACTERISTICS (T<sub>J</sub> = 25 °C unless otherwise specified)

SNUBBERLESS (3 quadrants)						
SYMBOL	TEST CONDITIONS	QUADRANT		20Txxxx		Unit
				CW	BW	
I <sub>GT</sub> <sup>(1)</sup>	V <sub>D</sub> = 12 V, R <sub>L</sub> = 33Ω	I - II - III	MAX.	35	50	mA
V <sub>GT</sub>		I - II - III	MAX.	1.5		V
V <sub>GD</sub>	V <sub>D</sub> = V <sub>DRM</sub> , R <sub>L</sub> = 3.3KΩ T <sub>j</sub> = 125°C	I - II - III	MIN.	0.2		V
I <sub>H</sub> <sup>(2)</sup>	I <sub>T</sub> = 500 mA		MAX.	40	60	mA
I <sub>L</sub>	I <sub>G</sub> = 1.2 I <sub>GT</sub>	I - III	MAX.	50	70	mA
		II		60	80	
dV/dt <sup>(2)</sup>	V <sub>D</sub> = 67% V <sub>DRM</sub> , gate open, T <sub>j</sub> = 125°C		MIN.	250	500	V/μs
(dI/dt) <sup>(2)</sup>	(dV/dt) <sub>c</sub> = 20 A/ms, T <sub>j</sub> = 125°C		MIN.	11	18	A/ms

STATIC CHARACTERISTICS					
SYMBOL	TEST CONDITIONS			VALUE	UNIT
V <sub>TM</sub> <sup>(2)</sup>	I <sub>TM</sub> = 28 A, t <sub>p</sub> = 380 μs	T <sub>j</sub> = 25°C	MAX.	1.55	V
V <sub>th</sub> <sup>(2)</sup>	Threshold voltage	T <sub>j</sub> = 125°C	MAX.	1.04	V
R <sub>d</sub> <sup>(2)</sup>	Dynamic resistance	T <sub>j</sub> = 125°C	MAX.	20	mΩ
I <sub>DRM</sub> I <sub>RDM</sub>	V <sub>D</sub> = V <sub>DRM</sub> V <sub>R</sub> = V <sub>RRM</sub>	T <sub>j</sub> = 25°C	MAX.	5	μA
		T <sub>j</sub> = 125°C		2.5	mA

Note 1: Minimum I<sub>GT</sub> is guaranteed at 5% of I<sub>GT</sub> max.

Note 2: For both polarities of A2 referenced to A1.

THERMAL RESISTANCE					
SYMBOL				VALUE	UNIT
R <sub>th(j-c)</sub>	Junction to case (AC)	TO-220AB, TO-263, TO-3P		1.3	°C/W
		TO-220AB Insulated, TO-3P Insulated		2.1	
R <sub>th(j-a)</sub>	Junction to ambient	S = 1 cm <sup>2</sup>	TO-263	45	
			TO-220AB Insulated, TO-220AB		
		TO-3P, TO-3P Insulated			

S = Copper surface under tab.

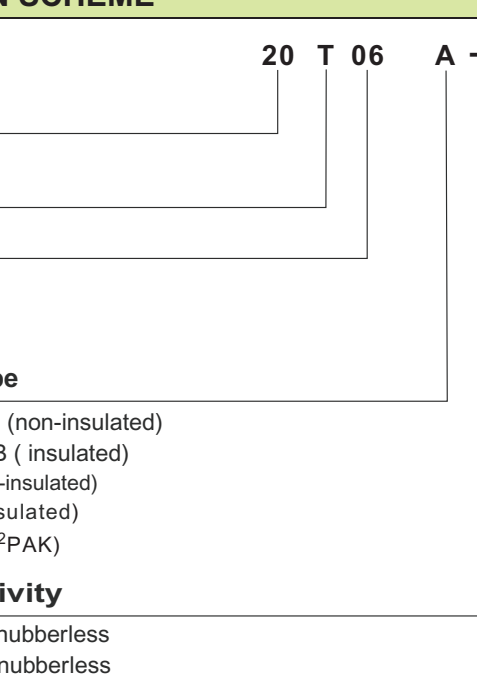
PRODUCT SELECTOR						
PART NUMBER	VOLTAGE (xx)			SENSITIVITY	TYPE	PACKAGE
	600 V	800 V	1000 V			
20TxxA-CW/20TxxAI-CW	V	V	V	35 mA	Snubberless	TO-220AB
20TxxA-BW/20TxxAI-BW	V	V	V	50 mA	Snubberless	TO-220AB
20TxxB-CW/20TxxBI-CW	V	V	V	35 mA	Snubberless	TO-3P
20TxxB-BW/20TxxBI-BW	V	V	V	50 mA	Snubberless	TO-3P
20TxxH-CW	V	V	V	35 mA	Snubberless	D <sup>2</sup> PAK
20TxxH-BW	V	V	V	50 mA	Snubberless	D <sup>2</sup> PAK

AI: Insulated TO-220AB package

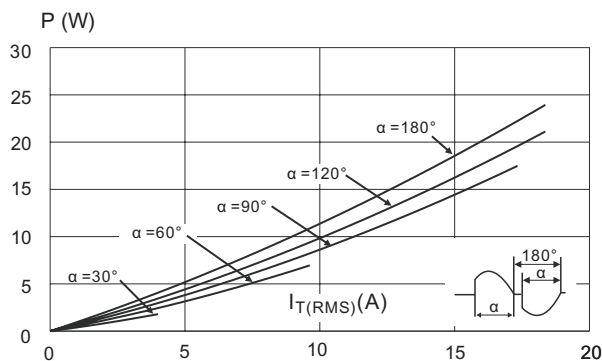
BI: Insulated TO-3P package

ORDERING INFORMATION					
ORDERING TYPE	MARKING	PACKAGE	WEIGHT	BASE Q'TY	DELIVERY MODE
20TxxA-yy	20TxxA-yy	TO-220AB	2.0g	50	Tube
20TxxAI-yy	20TxxAI-yy	TO-220AB (insulated)	2.3g	50	Tube
20TxxB-yy	20TxxB-yy	TO-3P	4.3g	30	Tube
20TxxBI-yy	20TxxBI-yy	TO-3P (insulated)	4.8g	30	Tube
20TxxH-yy	20TxxH-yy	TO-263(D <sup>2</sup> PAK)	2.0g	50	Tube

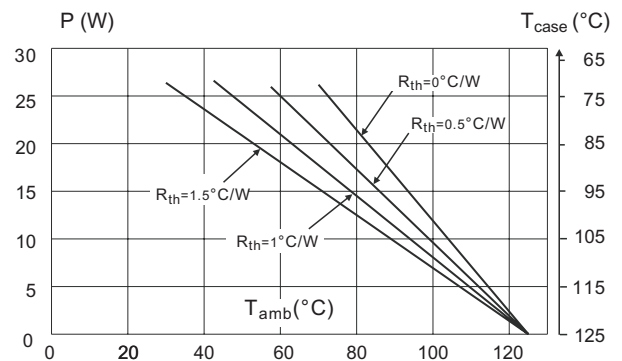
Note: xx = voltage, yy = sensitivity

ORDERING INFORMATION SCHEME	
<p><b>20 T 06 A - BW</b></p> <p><b>Current</b> 20 = 20A</p> <p><b>Triac series</b></p> <p><b>Voltage</b> 06 = 600V 08 = 800V 10 = 1000V</p> <p><b>Package type</b> A = TO-220AB (non-insulated) AI = TO-220AB (insulated) B = TO-3P (non-insulated) BI = TO-3P (insulated) H = TO-263 (D<sup>2</sup>PAK)</p> <p><b>I<sub>GT</sub> Sensitivity</b> BW = 50mA Snubberless CW = 35mA Snubberless</p>	

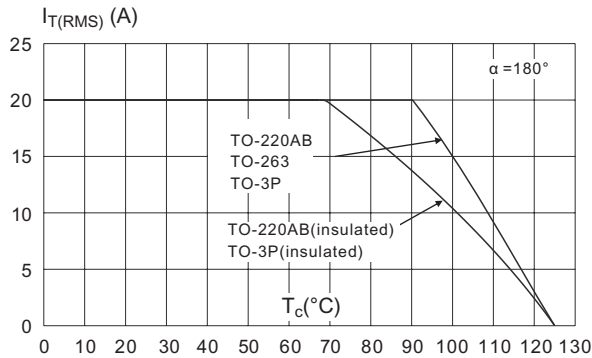
**Fig.1 Maximum power dissipation versus RMS on-state current (full cycle)**



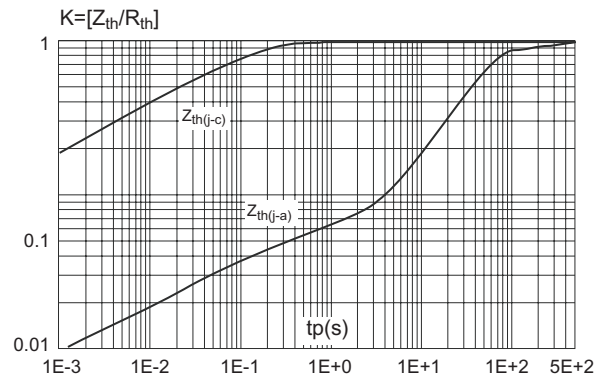
**Fig.2 Correlation between maximum RMS power dissipation and maximum allowable temperatures (T<sub>amb</sub> and T<sub>case</sub>) for different thermal resistances heatsink + contact**



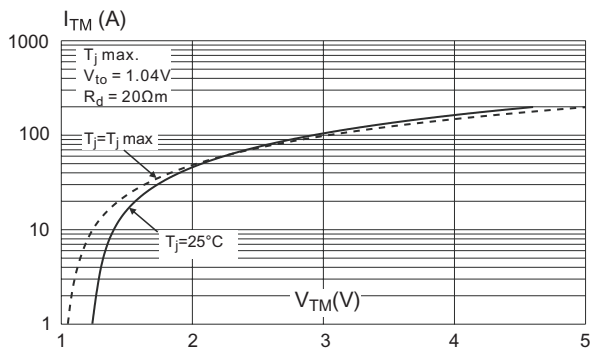
**Fig.3 RMS on-state current versus case temperature (full cycle)**



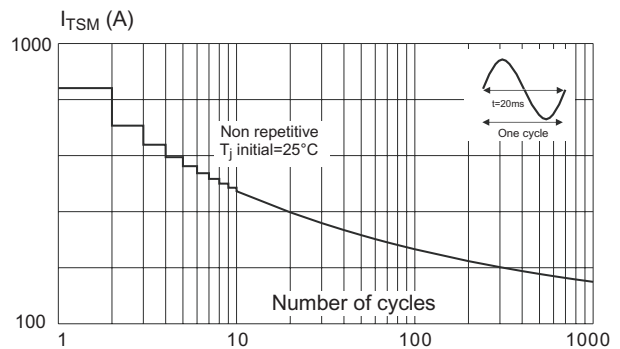
**Fig.4 Relative variation of thermal impedance versus pulse duration.**



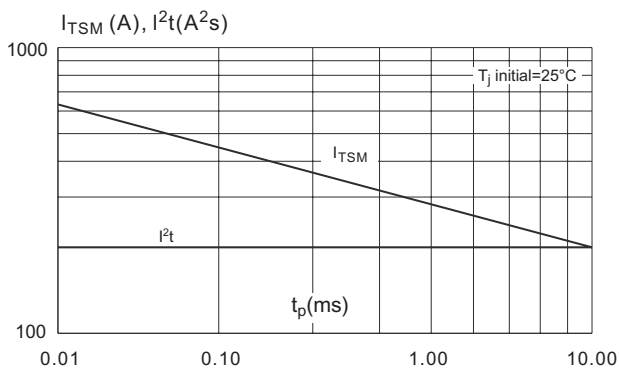
**Fig.5 On-state characteristics (maximum values).**



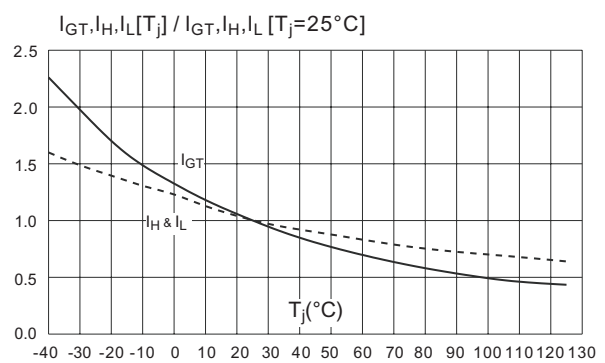
**Fig.6 Surge peak on-state current versus number of cycles.**



**Fig.7 Non-repetitive surge peak on-state current for a sinusoidal pulse with width  $t_p < 10ms$ . and corresponding value of  $I^2t$ .**

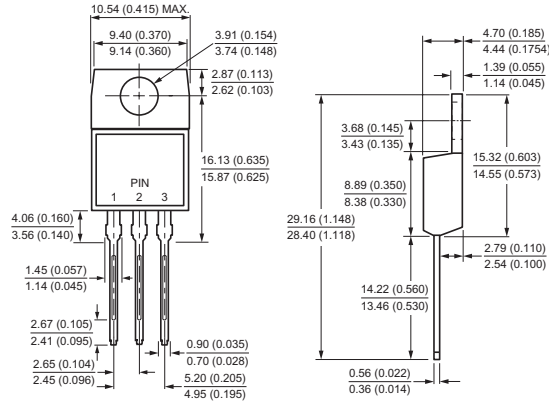


**Fig.8 Relative variation of gate trigger current and holding current versus junction temperature.**

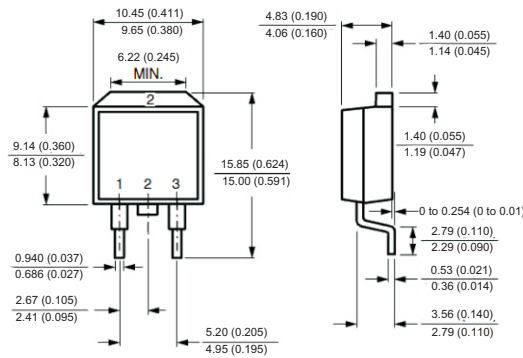


## Case Style

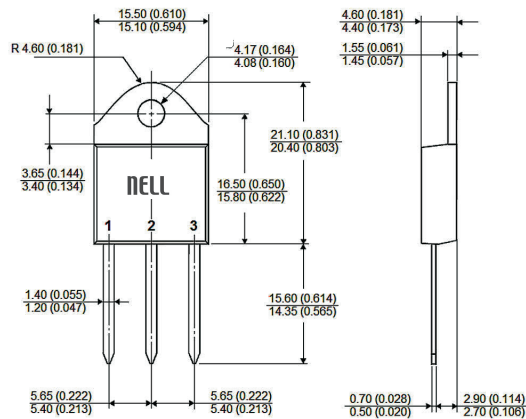
**TO-220AB**



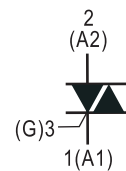
**TO-263(D<sup>2</sup>PAK)**



**TO-3P**



All dimensions in millimeters(inches)





## Стандарт Электрон Связь

Мы молодая и активно развивающаяся компания в области поставок электронных компонентов. Мы поставляем электронные компоненты отечественного и импортного производства напрямую от производителей и с крупнейших складов мира.

Благодаря сотрудничеству с мировыми поставщиками мы осуществляем комплексные и плановые поставки широчайшего спектра электронных компонентов.

Собственная эффективная логистика и склад в обеспечивает надежную поставку продукции в точно указанные сроки по всей России.

Мы осуществляем техническую поддержку нашим клиентам и предпродажную проверку качества продукции. На все поставляемые продукты мы предоставляем гарантию .

Осуществляем поставки продукции под контролем ВП МО РФ на предприятия военно-промышленного комплекса России , а также работаем в рамках 275 ФЗ с открытием отдельных счетов в уполномоченном банке. Система менеджмента качества компании соответствует требованиям ГОСТ ISO 9001.

Минимальные сроки поставки, гибкие цены, неограниченный ассортимент и индивидуальный подход к клиентам являются основой для выстраивания долгосрочного и эффективного сотрудничества с предприятиями радиоэлектронной промышленности, предприятиями ВПК и научно-исследовательскими институтами России.

С нами вы становитесь еще успешнее!

### Наши контакты:

**Телефон:** +7 812 627 14 35

**Электронная почта:** [sales@st-electron.ru](mailto:sales@st-electron.ru)

**Адрес:** 198099, Санкт-Петербург,  
Промышленная ул, дом № 19, литера Н,  
помещение 100-Н Офис 331