

Phase Control Thyristors (Stud Version), 200 A



TO-209AB (TO-93)

**RoHS
COMPLIANT**
FEATURES

- Center amplifying gate
- International standard case TO-209AB (TO-93)
- Hermetic metal case with ceramic insulator (Also available with glass-metal seal up to 1200 V)
- Compression bonded encapsulation for heavy duty operations such as severe thermal cycling
- Designed and qualified for industrial level
- Material categorization: For definitions of compliance please see www.vishay.com/doc?99912

TYPICAL APPLICATIONS

- DC motor controls
- Controlled DC power supplies
- AC controllers

PRODUCT SUMMARY

| | |
|-------------------|--------------------------------------|
| $I_{T(AV)}$ | 200 A |
| V_{DRM}/V_{RRM} | 400 V, 800 V, 1200 V, 1600 V, 2000 V |
| V_{TM} | 1.75 V |
| I_{GT} | 150 mA |
| T_J | -40 °C to 125 °C |
| Package | TO-209AB (TO-93) |
| Diode variation | Single SCR |

MAJOR RATINGS AND CHARACTERISTICS

| PARAMETER | TEST CONDITIONS | VALUES | UNITS |
|-------------------|-----------------|-------------|-------------------|
| $I_{T(AV)}$ | | 200 | A |
| | T_C | 85 | °C |
| $I_{T(RMS)}$ | | 314 | A |
| I_{TSM} | 50 Hz | 5000 | A |
| | 60 Hz | 5230 | |
| I^2t | 50 Hz | 125 | kA ² s |
| | 60 Hz | 114 | |
| V_{DRM}/V_{RRM} | | 400 to 2000 | V |
| t_q | Typical | 100 | µs |
| T_J | | -40 to 125 | °C |

ELECTRICAL SPECIFICATIONS
VOLTAGE RATINGS

| TYPE NUMBER | VOLTAGE CODE | V_{DRM}/V_{RRM} , MAXIMUM REPETITIVE PEAK AND OFF-STATE VOLTAGE V | V_{RSM} , MAXIMUM NON-REPETITIVE PEAK VOLTAGE V | I_{DRM}/I_{RRM} MAXIMUM AT $T_J = T_J$ MAXIMUM mA |
|-------------|--------------|------------------------------------------------------------------------|------------------------------------------------------|--------------------------------------------------------|
| VS-ST180S | 04 | 400 | 500 | 30 |
| | 08 | 800 | 900 | |
| | 12 | 1200 | 1300 | |
| | 16 | 1600 | 1700 | |
| | 20 | 2000 | 2100 | |



| ABSOLUTE MAXIMUM RATINGS | | | | | |
|------------------------------------------------------|---------------|----------------------------------------------------------------------------------------|---------------------------------------------------|----------------------------|--------------------|
| PARAMETER | SYMBOL | TEST CONDITIONS | | VALUES | UNITS |
| Maximum average on-state current at case temperature | $I_{T(AV)}$ | 180° conduction, half sine wave | | 200 | A |
| | | | | 85 | °C |
| Maximum RMS on-state current | $I_{T(RMS)}$ | DC at 76 °C case temperature | | 314 | |
| Maximum peak, one-cycle non-repetitive surge current | I_{TSM} | t = 10 ms | No voltage reappplied | 5000 | A |
| | | t = 8.3 ms | | 100 % V_{RRM} reappplied | |
| | | t = 10 ms | Sinusoidal half wave, initial $T_J = T_J$ maximum | | |
| | | t = 8.3 ms | | 4400 | |
| Maximum I^2t for fusing | I^2t | t = 10 ms | No voltage reappplied | 125 | kA ² s |
| | | t = 8.3 ms | | 100 % V_{RRM} reappplied | |
| | | t = 10 ms | Sinusoidal half wave, initial $T_J = T_J$ maximum | | |
| | | t = 8.3 ms | | 81 | |
| Maximum $I^2\sqrt{t}$ for fusing | $I^2\sqrt{t}$ | t = 0.1 to 10 ms, no voltage reappplied | | 1250 | kA ² √s |
| Low level value of threshold voltage | $V_{T(TO)1}$ | (16.7 % $\times \pi \times I_{T(AV)} < I < \pi \times I_{T(AV)}$, $T_J = T_J$ maximum | | 1.08 | V |
| High level value of threshold voltage | $V_{T(TO)2}$ | (I > $\pi \times I_{T(AV)}$, $T_J = T_J$ maximum | | 1.14 | |
| Low level value of on-state slope resistance | r_{t1} | (16.7 % $\times \pi \times I_{T(AV)} < I < \pi \times I_{T(AV)}$, $T_J = T_J$ maximum | | 1.18 | mΩ |
| High level value of on-state slope resistance | r_{t2} | (I > $\pi \times I_{T(AV)}$, $T_J = T_J$ maximum | | 1.14 | |
| Maximum on-state voltage | V_{TM} | $I_{pk} = 570$ A, $T_J = 125$ °C, $t_p = 10$ ms sine pulse | | 1.75 | V |
| Maximum holding current | I_H | $T_J = T_J$ maximum, anode supply 12 V resistive load | | 600 | mA |
| Maximum (typical) latching current | I_L | | | 1000 (300) | |

| SWITCHING | | | | | |
|----------------------------------------------------------|--------|--------------------------------------------------------------------------------------------------------------------------|--|--------|-------|
| PARAMETER | SYMBOL | TEST CONDITIONS | | VALUES | UNITS |
| Maximum non-repetitive rate of rise of turned-on current | di/dt | Gate drive 20 V, 20 Ω, $t_r \leq 1$ μs $T_J = T_J$ maximum, anode voltage ≤ 80 % V_{DRM} | | 1000 | A/μs |
| Typical delay time | t_d | Gate current 1 A, $dI_g/dt = 1$ A/μs $V_d = 0.67$ % V_{DRM} , $T_J = 25$ °C | | 1.0 | μs |
| Typical turn-off time | t_q | $I_{TM} = 300$ A, $T_J = T_J$ maximum, di/dt = 20 A/μs, $V_R = 50$ V, dV/dt = 20 V/μs, gate 0 V 100 Ω, $t_p = 500$ μs | | 100 | |

| BLOCKING | | | | | |
|----------------------------------------------------|--------------------------|------------------------------------------------------|--|--------|-------|
| PARAMETER | SYMBOL | TEST CONDITIONS | | VALUES | UNITS |
| Maximum critical rate of rise of off-state voltage | dV/dt | $T_J = T_J$ maximum linear to 80 % rated V_{DRM} | | 500 | V/μs |
| Maximum peak reverse and off-state leakage current | I_{RRM} , I_{DRM} | $T_J = T_J$ maximum, rated V_{DRM}/V_{RRM} applied | | 30 | mA |



| TRIGGERING | | | | | | |
|-------------------------------------|-------------|--------------------------------------------------------------------------------------------------------------------------------|----------------|------|-------|----|
| PARAMETER | SYMBOL | TEST CONDITIONS | VALUES | | UNITS | |
| | | | TYP. | MAX. | | |
| Maximum peak gate power | P_{GM} | $T_J = T_J$ maximum, $t_p \leq 5$ ms | 10 | | W | |
| Maximum average gate power | $P_{G(AV)}$ | $T_J = T_J$ maximum, $f = 50$ Hz, $d\% = 50$ | 2.0 | | | |
| Maximum peak positive gate current | I_{GM} | $T_J = T_J$ maximum, $t_p \leq 5$ ms | 3.0 | | A | |
| Maximum peak positive gate voltage | $+V_{GM}$ | $T_J = T_J$ maximum, $t_p \leq 5$ ms | 20 | | V | |
| Maximum peak negative gate voltage | $-V_{GM}$ | | 5.0 | | | |
| DC gate current required to trigger | I_{GT} | Maximum required gate trigger/ current/voltage are the lowest value which will trigger all units 12 V anode to cathode applied | $T_J = -40$ °C | 180 | - | mA |
| | | | $T_J = 25$ °C | 90 | 150 | |
| | | | $T_J = 125$ °C | 40 | - | |
| DC gate voltage required to trigger | V_{GT} | Maximum required gate trigger/ current/voltage are the lowest value which will trigger all units 12 V anode to cathode applied | $T_J = -40$ °C | 2.9 | - | V |
| | | | $T_J = 25$ °C | 1.8 | 3.0 | |
| | | | $T_J = 125$ °C | 1.2 | - | |
| DC gate current not to trigger | I_{GD} | $T_J = T_J$ maximum | 10 | | mA | |
| DC gate voltage not to trigger | V_{GD} | | 0.25 | | V | |

| THERMAL AND MECHANICAL SPECIFICATIONS | | | | |
|----------------------------------------------|--------------|-----------------------------------------------|------------------|---------------------|
| PARAMETER | SYMBOL | TEST CONDITIONS | VALUES | UNITS |
| Maximum operating junction temperature range | T_J | | -40 to 125 | °C |
| Maximum storage temperature range | T_{Stg} | | -40 to 150 | |
| Maximum thermal resistance, junction to case | R_{thJC} | DC operation | 0.105 | K/W |
| Maximum thermal resistance, case to heatsink | R_{thC-hs} | Mounting surface, smooth, flat and greased | 0.04 | |
| Mounting torque, ± 10 % | | Non-lubricated threads | 31 (275) | N · m (lbf · in) |
| | | Lubricated threads | 24.5 (210) | |
| Approximate weight | | | 280 | g |
| Case style | | See dimensions - link at the end of datasheet | TO-209AB (TO-93) | |

| ΔR_{thJC} CONDUCTION | | | | |
|------------------------------------------------|-----------------------|------------------------|---------------------|-------|
| CONDUCTION ANGLE | SINUSOIDAL CONDUCTION | RECTANGULAR CONDUCTION | TEST CONDITIONS | UNITS |
| 180° | 0.015 | 0.012 | $T_J = T_J$ maximum | K/W |
| 120° | 0.019 | 0.020 | | |
| 90° | 0.025 | 0.027 | | |
| 60° | 0.036 | 0.037 | | |
| 30° | 0.060 | 0.060 | | |

Note

- The table above shows the increment of thermal resistance R_{thJC} when devices operate at different conduction angles than DC

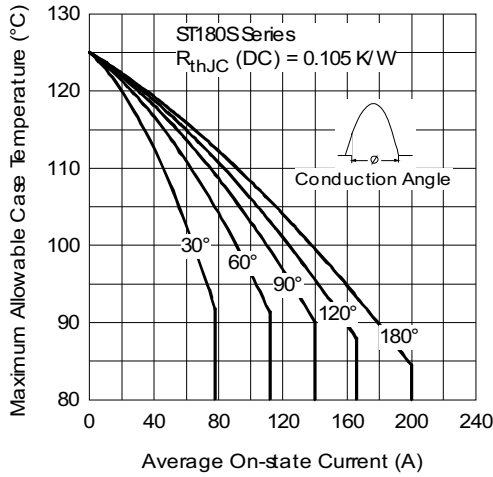

Fig. 1 - Current Ratings Characteristics

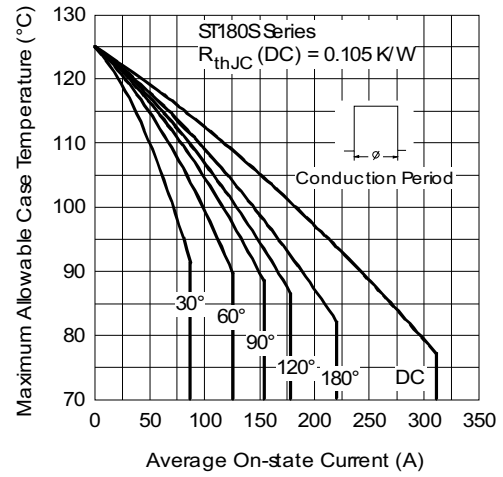

Fig. 2 - Current Ratings Characteristics

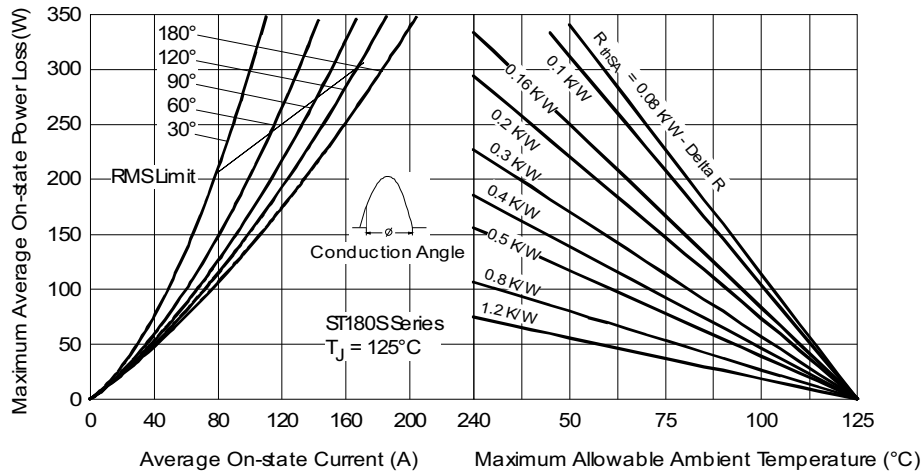

Fig. 3 - On-State Power Loss Characteristics

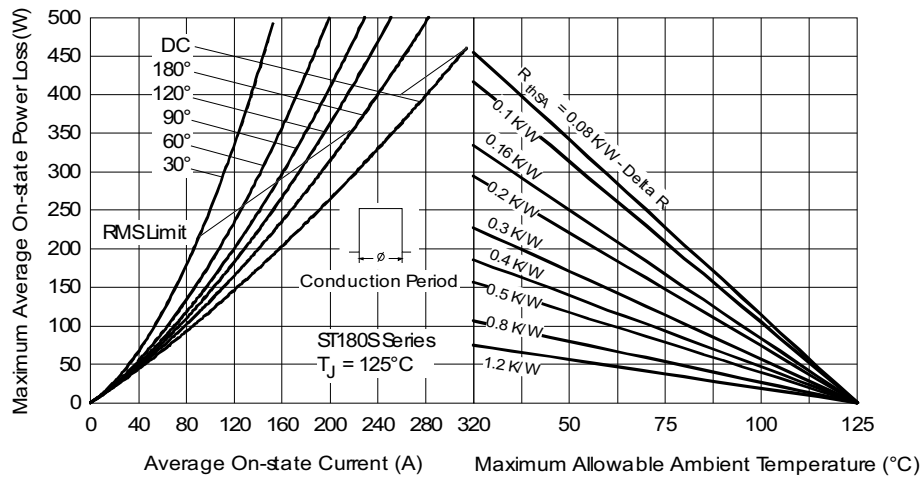

Fig. 4 - On-State Power Loss Characteristics

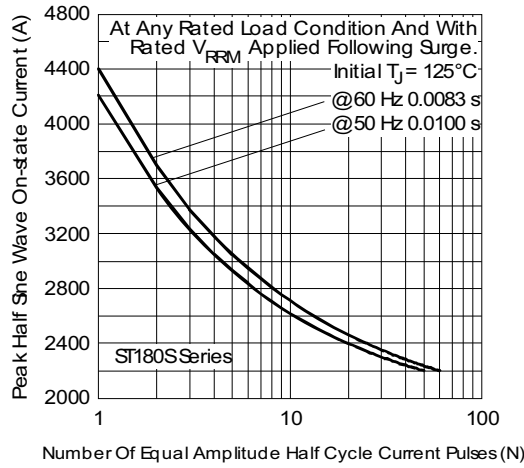

Fig. 5 - Maximum Non-Repetitive Surge Current

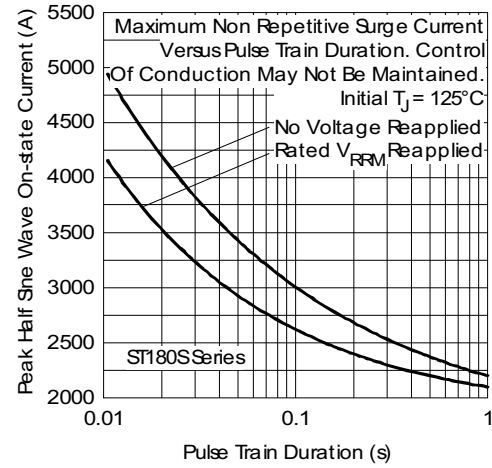

Fig. 6 - Maximum Non-Repetitive Surge Current

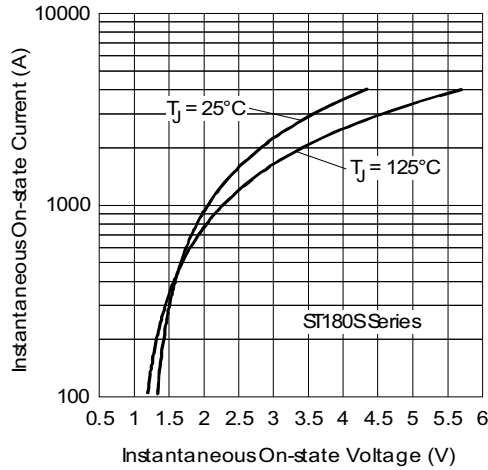

Fig. 7 - On-State Voltage Drop Characteristics

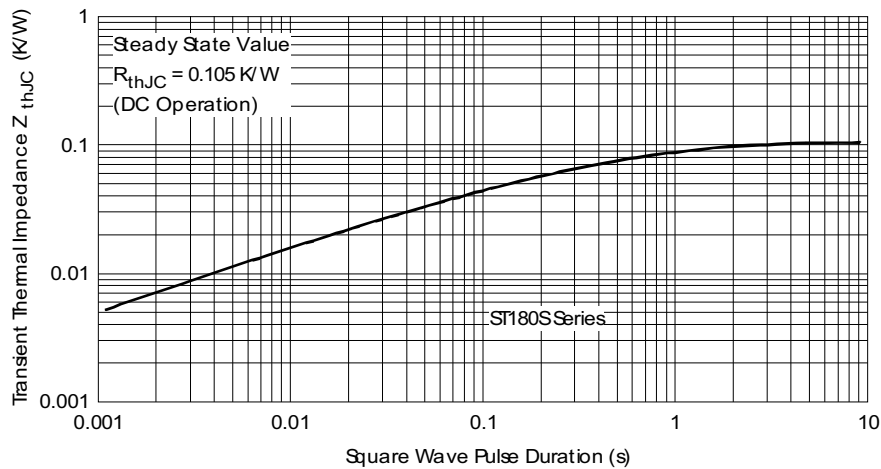

Fig. 8 - Thermal Impedance Z_{thJC} Characteristics

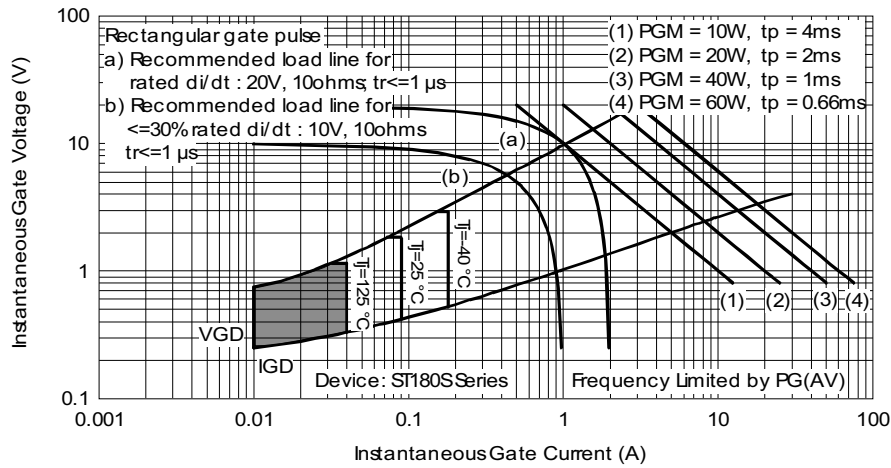

Fig. 9 - Gate Characteristics

ORDERING INFORMATION TABLE

| | | | | | | | | | | |
|-------------|------------|-----------|-----------|----------|----------|-----------|----------|----------|----------|------------|
| Device code | VS- | ST | 18 | 0 | S | 20 | P | 0 | - | PbF |
| | (1) | (2) | (3) | (4) | (5) | (6) | (7) | (8) | (9) | (10) |

- 1** - Vishay Semiconductors product
- 2** - Thyristor
- 3** - Essential part number
- 4** - 0 = Converter grade
- 5** - S = Compression bonding stud
- 6** - Voltage code x 100 = V_{RRM} (see Voltage Ratings table)
- 7** - P = Stud base 3/4"-16UNF2A threads
- 8** - 0 = Eyelet terminals (gate and auxiliary cathode leads)
1 = Fast-on terminals (gate and auxiliary cathode leads)
- 9** - V = Glass-metal seal (only up to 1200 V)
None = Ceramic housing (over 1200 V)
- 10** - None = Standard production
PbF = Lead (Pb)-free

Note: For metric device M16 x 1.5 contact factory

| LINKS TO RELATED DOCUMENTS | |
|----------------------------|------------------------------------------------------------------------|
| Dimensions | www.vishay.com/doc?95082 |



TO-209AB (TO-93)

DIMENSIONS in millimeters (inches)

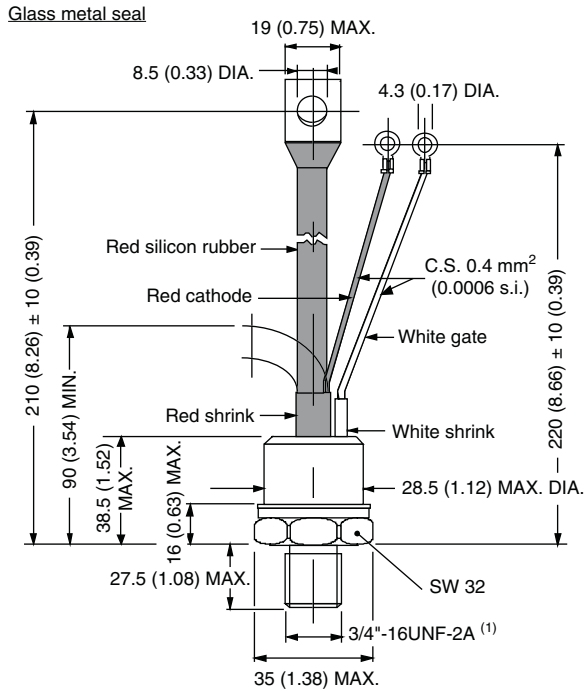

Note

(1) For metric device: M16 x 1.5 - length 21 (0.83) maximum



Disclaimer

ALL PRODUCT, PRODUCT SPECIFICATIONS AND DATA ARE SUBJECT TO CHANGE WITHOUT NOTICE TO IMPROVE RELIABILITY, FUNCTION OR DESIGN OR OTHERWISE.

Vishay Intertechnology, Inc., its affiliates, agents, and employees, and all persons acting on its or their behalf (collectively, "Vishay"), disclaim any and all liability for any errors, inaccuracies or incompleteness contained in any datasheet or in any other disclosure relating to any product.

Vishay makes no warranty, representation or guarantee regarding the suitability of the products for any particular purpose or the continuing production of any product. To the maximum extent permitted by applicable law, Vishay disclaims (i) any and all liability arising out of the application or use of any product, (ii) any and all liability, including without limitation special, consequential or incidental damages, and (iii) any and all implied warranties, including warranties of fitness for particular purpose, non-infringement and merchantability.

Statements regarding the suitability of products for certain types of applications are based on Vishay's knowledge of typical requirements that are often placed on Vishay products in generic applications. Such statements are not binding statements about the suitability of products for a particular application. It is the customer's responsibility to validate that a particular product with the properties described in the product specification is suitable for use in a particular application. Parameters provided in datasheets and/or specifications may vary in different applications and performance may vary over time. All operating parameters, including typical parameters, must be validated for each customer application by the customer's technical experts. Product specifications do not expand or otherwise modify Vishay's terms and conditions of purchase, including but not limited to the warranty expressed therein.

Except as expressly indicated in writing, Vishay products are not designed for use in medical, life-saving, or life-sustaining applications or for any other application in which the failure of the Vishay product could result in personal injury or death. Customers using or selling Vishay products not expressly indicated for use in such applications do so at their own risk. Please contact authorized Vishay personnel to obtain written terms and conditions regarding products designed for such applications.

No license, express or implied, by estoppel or otherwise, to any intellectual property rights is granted by this document or by any conduct of Vishay. Product names and markings noted herein may be trademarks of their respective owners.

Material Category Policy

Vishay Intertechnology, Inc. hereby certifies that all its products that are identified as RoHS-Compliant fulfill the definitions and restrictions defined under Directive 2011/65/EU of The European Parliament and of the Council of June 8, 2011 on the restriction of the use of certain hazardous substances in electrical and electronic equipment (EEE) - recast, unless otherwise specified as non-compliant.

Please note that some Vishay documentation may still make reference to RoHS Directive 2002/95/EC. We confirm that all the products identified as being compliant to Directive 2002/95/EC conform to Directive 2011/65/EU.

Vishay Intertechnology, Inc. hereby certifies that all its products that are identified as Halogen-Free follow Halogen-Free requirements as per JEDEC JS709A standards. Please note that some Vishay documentation may still make reference to the IEC 61249-2-21 definition. We confirm that all the products identified as being compliant to IEC 61249-2-21 conform to JEDEC JS709A standards.



Стандарт Электрон Связь

Мы молодая и активно развивающаяся компания в области поставок электронных компонентов. Мы поставляем электронные компоненты отечественного и импортного производства напрямую от производителей и с крупнейших складов мира.

Благодаря сотрудничеству с мировыми поставщиками мы осуществляем комплексные и плановые поставки широчайшего спектра электронных компонентов.

Собственная эффективная логистика и склад в обеспечивает надежную поставку продукции в точно указанные сроки по всей России.

Мы осуществляем техническую поддержку нашим клиентам и предпродажную проверку качества продукции. На все поставляемые продукты мы предоставляем гарантию .

Осуществляем поставки продукции под контролем ВП МО РФ на предприятия военно-промышленного комплекса России , а также работаем в рамках 275 ФЗ с открытием отдельных счетов в уполномоченном банке. Система менеджмента качества компании соответствует требованиям ГОСТ ISO 9001.

Минимальные сроки поставки, гибкие цены, неограниченный ассортимент и индивидуальный подход к клиентам являются основой для выстраивания долгосрочного и эффективного сотрудничества с предприятиями радиоэлектронной промышленности, предприятиями ВПК и научно-исследовательскими институтами России.

С нами вы становитесь еще успешнее!

Наши контакты:

Телефон: +7 812 627 14 35

Электронная почта: sales@st-electron.ru

Адрес: 198099, Санкт-Петербург,
Промышленная ул, дом № 19, литера Н,
помещение 100-Н Офис 331