

Evolution Dual Series



- 25A & 50A Output rating per channel @ 40°C
- 24 to 280 & 48 to 600VAC Operating voltage
- 4-15, 15-32 & 4-32VDC Control input options
- Four input termination options
- Zero-crossing (resistive loads) or random-fire (inductive loads) output
- Input status LED indicator for each channel
- Available with IP20 “Touch-Safe” Covers
- UL508 Endurance Rating

PRODUCT SELECTION

Control Voltage	240V,25A	240V, 50A	480V, 25A	480V, 50A
4-15 VDC	CD2425D1U	CD2450D1U	CD4825D1U	CD4850D1U
15-32VDC	CD2425E1U	CD2450E1U	CD4825E1U	CD4850E1U
4-32 VDC	CD2425W1U	CD2450W1U	CD4825W1U	CD4850W1U

AVAILABLE OPTIONS

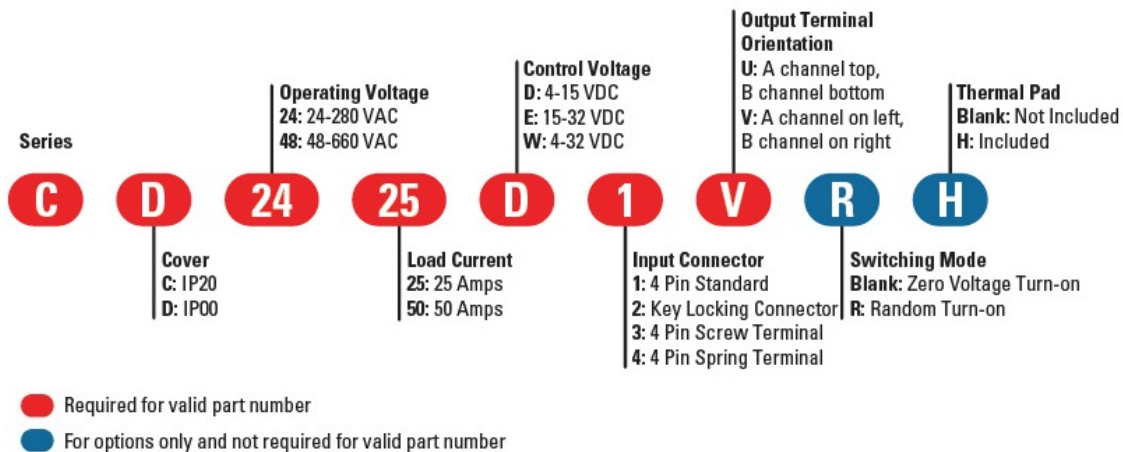

OUTPUT SPECIFICATIONS (1)

Description	Cx2425xxxx	Cx2450xxxx	Cx4825xxxx	Cx4850xxxx
Operating Voltage (47-440Hz) [Vrms]	24-280	24-280	48-600	48-600
Load Current Range (3) [Arms]	0.15-25	0.15-50	0.15-25	0.15-50
Transient Overvoltage [Vpk]	600	600	1200	1200
Maximum Off-State Leakage Current @ Rated Voltage [mA rms]	1.0	1.0	1.0	1.0
Minimum Off-State dv/dt @ Maximum Rated Voltage [V/μsec] (2)	500	500	500	500
Maximum 1 Cycle Surge Current (50/60) [A pk]	275/300	710/750	275/300	710/750
Maximum Surge Current 50Hz (20ms) [A pk]	275	710	275	710
Maximum On-State Voltage Drop @ Rated Current [Vpk]	1.3	1.3	1.3	1.3
Thermal Resistance Junction to Case [Rjc] [°C/W]	0.65	0.33	0.65	0.33
Maximum I ² t for Fusing 50/60Hz (1/2 cycle) [A ² sec]	380/370	2520/2320	380/370	2520/2320
Minimum Power Factor (with Maximum Load)	0.5	0.5	0.5	0.5

INPUT SPECIFICATIONS (1)

Description	CxxxDxxx	CxxxExxx	CxxxWxxx
Control Voltage Range	4-15 VDC	15-32 VDC	4-32 VDC
Minimum Turn-On Voltage	4 VDC	15 VDC	4 VDC
Minimum Turn-Off Voltage	1.0 VDC	1.0 VDC	1.0 VDC
Typical Input Current	16 mA @ 5 VDC	18 mA @ 24 VDC	10 mA @ 12 VDC
Nominal Input Impedance	300 Ohm	1500 Ohm	See Note 5
Maximum Turn-On Time [msec] (4)	1/2 Cycle	1/2 Cycle	1/2 Cycle
Maximum Turn-Off Time [msec]	1/2 Cycle	1/2 Cycle	1/2 Cycle

GENERAL SPECIFICATIONS

Description	Parameters
Dielectric Strength, Input/Output (50/60Hz)	4000 Vrms
Dielectric Strength, Input/Output/Base (50/60Hz)	2500 Vrms
Minimum Insulation Resistance (@ 500 V DC)	10 ⁹ Ohm
Maximum Capacitance, Input/Output	10 pF
Ambient Operating Temperature Range	-40 to 80 °C
Ambient Storage Temperature Range	-40 to 125 °C
Weight (typical)	3.0 oz (86.5 g)
Terminals	Screw Type Output: 8-32
Max. Torque	Output: 20 in lb (2.2Nm)
Max. Wire Size	Output: 2 x AWG 8 (3.8mm)

GENERAL NOTES

- 1) All parameters at 25°C and per section unless otherwise specified.
- 2) Off-state dv/dt test method per EIA/NARM standard RS-443, paragraph 13.11.1
- 3) Heat sinking required, see derating curves.
- 4) Turn-on time for random turn-on (R) versions is 0.1 msec.
- 5) Input circuit incorporates active current limitation

WIRING DIAGRAM

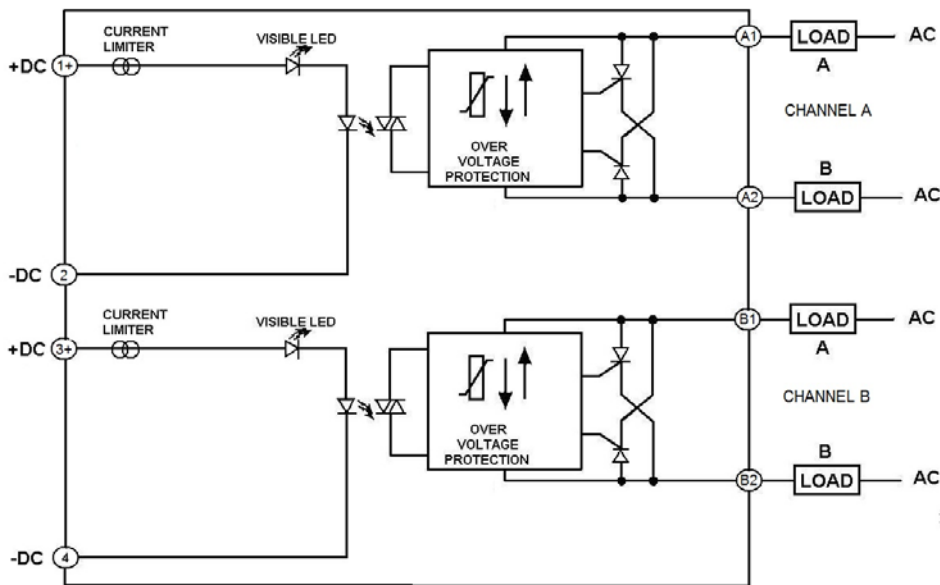

LOAD CAN BE WIRED IN POSITION A or B

MECHANICAL SPECIFICATIONS

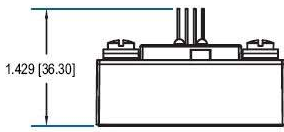
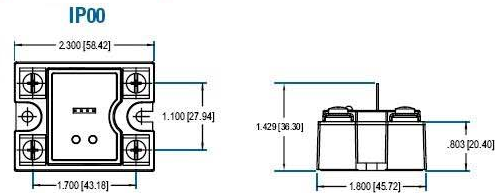
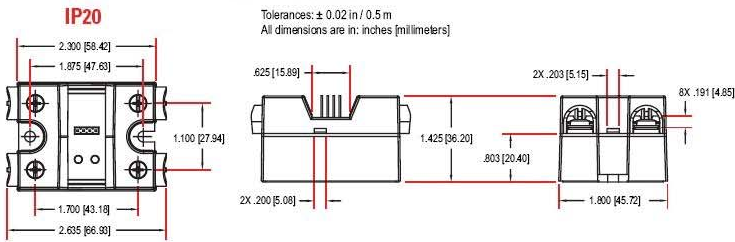

INPUT CONNECTOR
OPTION 1

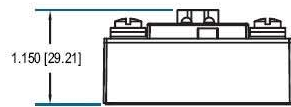

INPUT CONNECTOR
OPTION 2

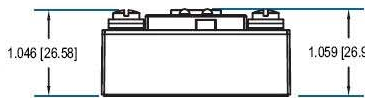

INPUT CONNECTOR
OPTION 3

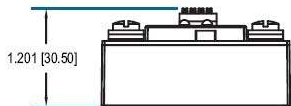

INPUT CONNECTOR
OPTION 4

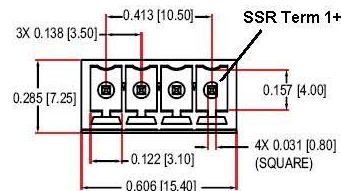
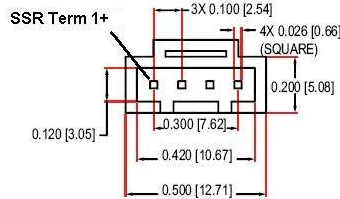
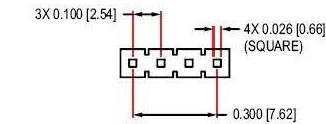

SUGGESTED MATING CONNECTORS/PLUGS

- | | |
|---|--|
| OPTION 1
Pin Connector
TYCO 3-640440-4
Accepts wires: AWG #22 | OPTION 2
Crimp Housing, Positive Latch
Molex 050579404
Accepts wires: AWG #24, 0.2 mm ² |
|---|--|

Wiring Diagrams

SSR Output Configuration "U" Option Top-Bottom Line/Load Connections

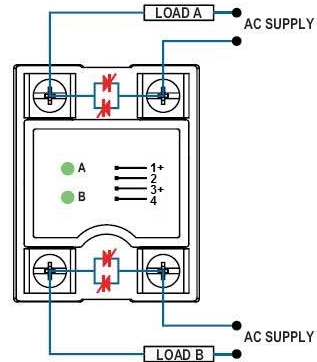

Contactor Output Configuration "V" Option Left-Right Line/Load Connections

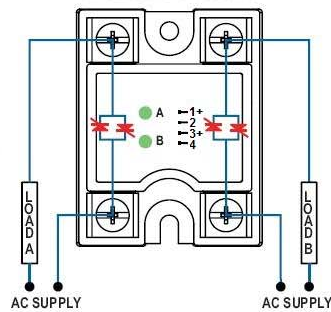

SUGGESTED MATING CONNECTORS/PLUGS

OPTION 3

- | | |
|--|--|
| Vertical Plug, Top Wire entry
Molex 039500-0004
Phoenix 1840382
Dinkle EC350V-04P | Vertical Plug, Front Wire entry
Molex 39503-3004
Phoenix 1863178
Dinkle EC350R-04P |
| Vertical Plug, Rear Wire entry
Molex 39503-2004
Phoenix 1862878
Dinkle EC350RL-04P | Vertical Spring Cage Plug, top Wire E
Phoenix 1939934
Dinkle 0221-2004
All 4 options accept wires: AWG #16 to 24 |

THERMAL DERATE INFORMATION

**DERATING CURVE:
25A Evolution Dual SSR**

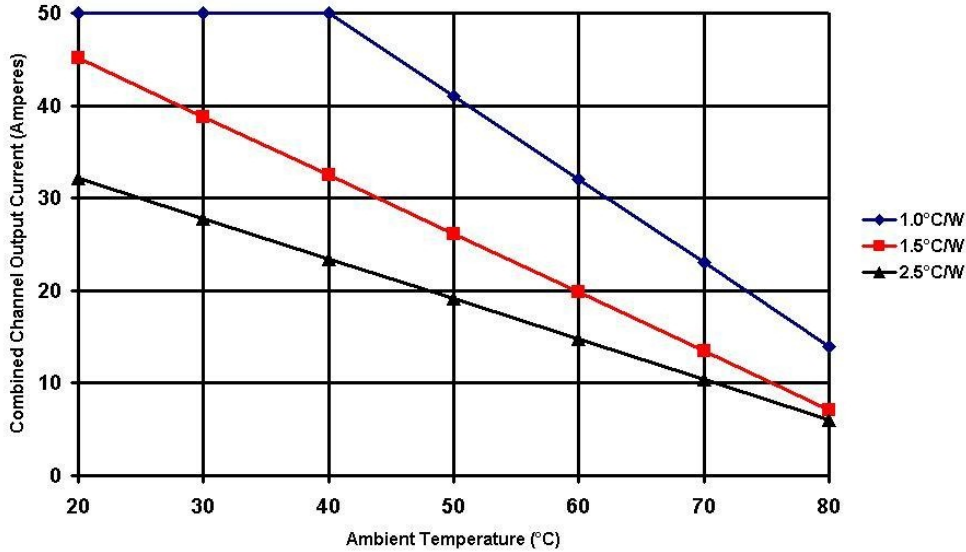

**DERATE CURVE:
50A Evolution Dual SSR**

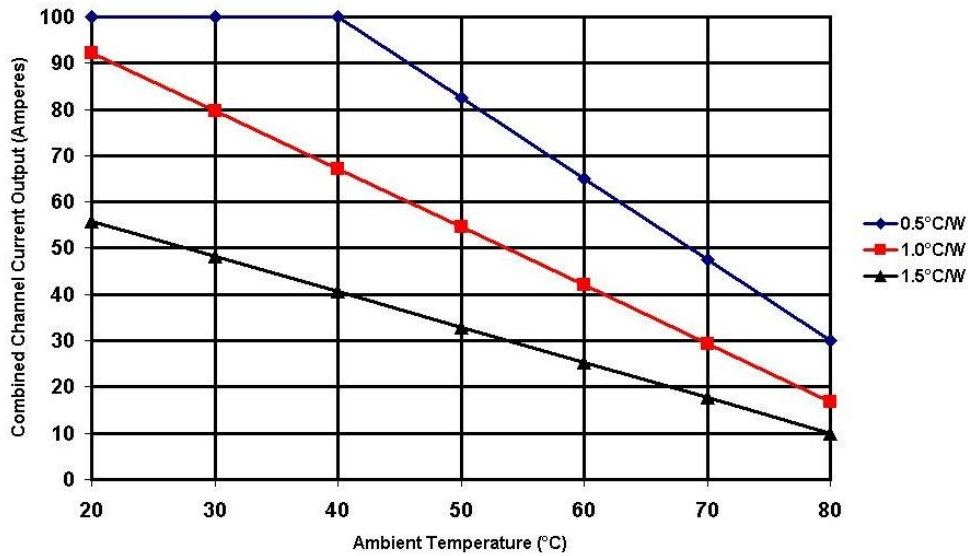



AGENCY APPROVALS

Designed in accordance with the requirements of IEC 62314



Rev. 113011

 DANGER / PELIGRO / DANGER /GEFAHR / PERICOLO / PERIGO					
HAZARD OF ELECTRIC SHOCK, EXPLOSION, OR ARC FLASH. <ul style="list-style-type: none"> Disconnect all power before installing or working with this equipment. Verify all connections and replace all covers before turning on power. <p>Failure to follow these instructions will result in death or serious injury.</p>	RIESGO DE DESCARGA ELECTRICA O EXPLOSION. <ul style="list-style-type: none"> Desconectar todos los suministros de energia a este equipo antes de trabajar con este equipo. Verificar todas las conexiones y colocar todas las tapas antes de energizar el equipo. <p>El incumplimiento de estas instrucciones puede provocar la muerte o lesiones serias.</p>	RISQUE DE DESCARGE ELECTRIQUE OU EXPLOSION <ul style="list-style-type: none"> Eteindre toutes les sources d'énergie de cet appareil avant de travailler dessus de cet appareil Vérifier tous connections, et remettre tous couverts en place avant de mettre sous <p>De non-suivi de ces instructions provoquera la mort ou des lésions sérieuses sérieuses.</p>	GEFAHR EINES ELEKTRISCHE N SCHLAGES ODER EINER EXPLOSION. <ul style="list-style-type: none"> Stellen Sie jeglichen Strom ab, der dieses Gerät versorgt, bevor Sie an dem Gerät Arbeiten durchführen Vor der Inbetriebnahme alle Anschlüsse überprüfen und alle Gehäuseteile montieren. <p>Unterlassung dieser Anweisungen können zum Tode oder zu schweren Verletzungen führen.</p>	RISCHIO DI SCOSSA ELETTRICA O DELL'ESPLOSIONE. <ul style="list-style-type: none"> Spenga tutta l'alimentazione e che fornisce questa apparecchiatura prima del lavorare a questa apparecchiatura Verificare tutti i collegamenti e sostituire tutte le coperture prima della rotazione sull'alimentazione <p>L'omissione di seguire queste istruzioni provocherà la morte o di lesioni serie</p>	RISCO DE DESCARGA ELÉTRICA OU EXPLOÇÃO <ul style="list-style-type: none"> Desconectar o equipamento de toda a energia antes de instalar ou trabalhar com este equipamento Verificar todas as conexões e recolocar todas as tampas antes de religar o equipamento <p>O não cumprimento destas instruções pode levar à morte ou lesões sérias.</p>

 WARNING / AVERTISSEMENT / WARNUNG /ADVERTENCIA / AVVERTENZA / AVISO		
RISK OF MATERIAL DAMAGE AND HOT ENCLOSURE <ul style="list-style-type: none"> The product's side panels may be hot, allow the product to cool before touching. Follow proper mounting instructions including torque values. Do not allow liquids or foreign objects to enter this product. <p>Failure to follow these instructions can result in serious injury, or equipment damage.</p>	RISQUE DE DOMMAGE MATERIEL ET DE SURCHAUFFE DU BOITIER <ul style="list-style-type: none"> Les panneaux latéraux du produit peuvent être chauds. Laisser le produit refroidir avant de le toucher. Respecter les consignes de montage, et notamment les couples de serrage. Ne pas laisser pénétrer de liquide ni de corps étrangers à l'intérieur du produit. <p>Le non-respect de cette directive peut entraîner, des lésions corporelles graves ou des dommages matériels.</p>	GEFAHR VON MATERIALSCHÄDEN UND GEHÄUSEERHITZUNG <ul style="list-style-type: none"> Die Seitenwände können heiß sein. Lassen Sie das Produkt abkühlen, bevor Sie es berühren. Beachten Sie die Montageanweisungen, Führen Sie keine Flüssigkeiten oder Fremdkörper in das Produkt ein. <p>Die Nichtbeachtung dieser Anweisung kann Körperverletzung oder Materialschäden zur Folge haben.</p>
RIESGO DE DAÑOS MATERIALES Y DE SOBRECIENTAMIENTO DE LA UNIDAD <ul style="list-style-type: none"> Los paneles laterales del producto pueden estar calientes. Esperar que el producto se enfríe antes de tocarlo. Respetar las instrucciones de montaje, y en particular los pares de apretado. No dejar que penetren líquidos o cuerpos extraños en el producto. <p>Si no se respetan estas precauciones pueden producirse graves lesiones, daños materiales.</p>	RISCHIO DI DANNI MATERIALI E D'INVOLUCRO CALDO <ul style="list-style-type: none"> I pannelli laterali dell'apparecchio possono scottare; lasciar quindi raffreddare il prodotto prima di toccarlo. Seguire le istruzioni di montaggio corrette. Non far entrare liquidi o oggetti estranei in questo apparecchio. <p>La mancata osservanza di questa precauzione può causare gravi rischi per l'incolumità personale o danni alle apparecchiature.</p>	RISCO DE DANO MATERIAL E DE AQUECIMENTO <ul style="list-style-type: none"> Os painéis laterais do produto podem estar quentes; dê tempo ao produto para arrefecer antes de lhe tocar. Siga devidamente as instruções de montagem. Não permita a entrada de líquidos e de objectos estranhos no produto. <p>A não observância destas precauções pode provocar a morte, ferimentos graves ou danos materiais.</p>

ANNEX - ENVIROMENTAL INFORMATION

The environmental information disclosed in this annex including the EIP Pollution logo are in compliance with People's Republic of China Electronic Industry Standard SJ/T11364 – 2006, Marking for Control of Pollution Caused by Electronic Information Products.

Part Name	Toxic or hazardous Substance and Elements					
	Lead (Pb)	Mercury (Hg)	Cadmium (Cd)	Hexavalent Chromium (Cr (VI))	Polybrominated biphenyls (PBB)	Polybrominated diphenyl ethers (PBDE)
Semiconductor die	X	○	○	○	○	○
Solder	X	○	○	○	○	○

此附件所标示的包括电子信息产品污染图标的环保信息符合中华人民共和国电子行业标准 **SJ/T11364 - 2006**, 电子信息产品污染控制标识要求



部件名称	有毒有害物质或元素					
	铅 (Pb)	汞 (Hg)	镉 (Cd)	六价铬 (Cr (VI))	多溴联苯 (PBB)	多溴二苯醚 (PBDE)
半导体芯片	X	○	○	○	○	○
焊接点	X	○	○	○	○	○



Стандарт Электрон Связь

Мы молодая и активно развивающаяся компания в области поставок электронных компонентов. Мы поставляем электронные компоненты отечественного и импортного производства напрямую от производителей и с крупнейших складов мира.

Благодаря сотрудничеству с мировыми поставщиками мы осуществляем комплексные и плановые поставки широчайшего спектра электронных компонентов.

Собственная эффективная логистика и склад в обеспечивает надежную поставку продукции в точно указанные сроки по всей России.

Мы осуществляем техническую поддержку нашим клиентам и предпродажную проверку качества продукции. На все поставляемые продукты мы предоставляем гарантию .

Осуществляем поставки продукции под контролем ВП МО РФ на предприятия военно-промышленного комплекса России , а также работаем в рамках 275 ФЗ с открытием отдельных счетов в уполномоченном банке. Система менеджмента качества компании соответствует требованиям ГОСТ ISO 9001.

Минимальные сроки поставки, гибкие цены, неограниченный ассортимент и индивидуальный подход к клиентам являются основой для выстраивания долгосрочного и эффективного сотрудничества с предприятиями радиоэлектронной промышленности, предприятиями ВПК и научно-исследовательскими институтами России.

С нами вы становитесь еще успешнее!

Наши контакты:

Телефон: +7 812 627 14 35

Электронная почта: sales@st-electron.ru

Адрес: 198099, Санкт-Петербург,
Промышленная ул, дом № 19, литера Н,
помещение 100-Н Офис 331