



MICROCHIP MCP6241/1R/1U/2/4

50 μ A, 550 kHz Rail-to-Rail Op Amp

Features

- Gain Bandwidth Product: 550 kHz (typical)
- Supply Current: $I_Q = 50 \mu\text{A}$ (typical)
- Supply Voltage: 1.8V to 5.5V
- Rail-to-Rail Input/Output
- Extended Temperature Range: -40°C to $+125^\circ\text{C}$
- Available in 5-pin SC-70 and SOT-23 packages

Applications

- Automotive
- Portable Equipment
- Photodiode (Transimpedance) Amplifier
- Analog Filters
- Notebooks and PDAs
- Battery-Powered Systems

Design Aids

- SPICE Macro Models
- Mindi™ Circuit Designer & Simulator
- Microchip Advanced Part Selector (MAPS)
- Analog Demonstration and Evaluation Boards
- Application Notes

Typical Application



Description

The Microchip Technology Inc. MCP6241/1R/1U/2/4 operational amplifiers (op amps) provide wide bandwidth for the quiescent current. The MCP6241/1R/1U/2/4 has a 550 kHz gain bandwidth product and 68° (typical) phase margin. This family operates from a single supply voltage as low as 1.8V, while drawing 50 μA (typical) quiescent current. In addition, the MCP6241/1R/1U/2/4 family supports rail-to-rail input and output swing, with a common mode input voltage range of $V_{DD} + 300 \text{ mV}$ to $V_{SS} - 300 \text{ mV}$. These op amps are designed in one of Microchip's advanced CMOS processes.

Package Types

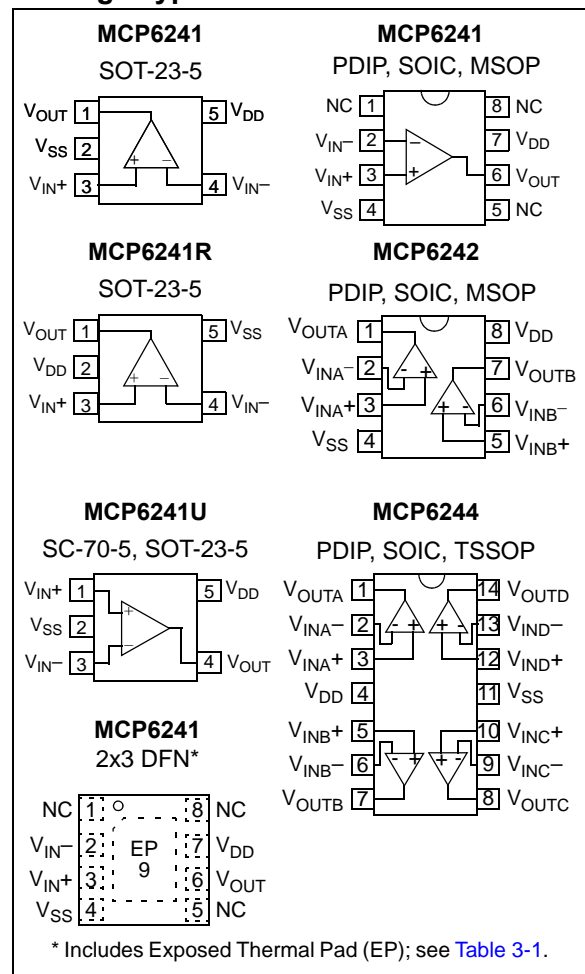

MCP6241/1R/1U/2/4

NOTES:

1.0 ELECTRICAL CHARACTERISTICS

Absolute Maximum Ratings †

$V_{DD} - V_{SS}$	7.0V
Current at Analog Input Pins (V_{IN+} , V_{IN-}).....	± 2 mA
Analog Inputs (V_{IN+} , V_{IN-}) ††	$V_{SS} - 1.0V$ to $V_{DD} + 1.0V$
All Other Inputs and Outputs	$V_{SS} - 0.3V$ to $V_{DD} + 0.3V$
Difference Input Voltage	$ V_{DD} - V_{SS} $
Output Short Circuit Current	Continuous
Current at Output and Supply Pins	± 30 mA
Storage Temperature	$-65^{\circ}C$ to $+150^{\circ}C$
Maximum Junction Temperature (T_J).....	$+150^{\circ}C$
ESD Protection On All Pins (HBM; MM)	≥ 4 kV; 300V

† **Notice:** Stresses above those listed under “Absolute Maximum Ratings” may cause permanent damage to the device. This is a stress rating only and functional operation of the device at those or any other conditions above those indicated in the operational listings of this specification is not implied. Exposure to maximum rating conditions for extended periods may affect device reliability.

†† See Section 4.1.2 “Input Voltage and Current Limits”.

DC ELECTRICAL CHARACTERISTICS

Electrical Characteristics: Unless otherwise indicated, $T_A = +25^{\circ}C$, $V_{DD} = +1.8V$ to $+5.5V$, $V_{SS} = GND$, $V_{CM} = V_{DD}/2$, $R_L = 100$ k Ω to $V_{DD}/2$ and $V_{OUT} \approx V_{DD}/2$.

Parameters	Sym	Min	Typ	Max	Units	Conditions
Input Offset						
Input Offset Voltage	V_{OS}	-5.0	—	+5.0	mV	$V_{CM} = V_{SS}$
Extended Temperature	V_{OS}	-7.0	—	+7.0	mV	$T_A = -40^{\circ}C$ to $+125^{\circ}C$, $V_{CM} = V_{SS}$ (Note 1)
Input Offset Drift with Temperature	$\Delta V_{OS}/\Delta T_A$	—	± 3.0	—	$\mu V/^{\circ}C$	$T_A = -40^{\circ}C$ to $+125^{\circ}C$, $V_{CM} = V_{SS}$
Power Supply Rejection	PSRR	—	83	—	dB	$V_{CM} = V_{SS}$
Input Bias Current and Impedance						
Input Bias Current:	I_B	—	± 1.0	—	pA	
At Temperature	I_B	—	20	—	pA	$T_A = +85^{\circ}C$
At Temperature	I_B	—	1100	—	pA	$T_A = +125^{\circ}C$
Input Offset Current	I_{OS}	—	± 1.0	—	pA	
Common Mode Input Impedance	Z_{CM}	—	$10^{13} 6$	—	ΩpF	
Differential Input Impedance	Z_{DIFF}	—	$10^{13} 3$	—	ΩpF	
Common Mode						
Common Mode Input Range	V_{CMR}	$V_{SS} - 0.3$	—	$V_{DD} + 0.3$	V	
Common Mode Rejection Ratio	CMRR	60	75	—	dB	$V_{CM} = -0.3V$ to $5.3V$, $V_{DD} = 5V$
Open-Loop Gain						
DC Open-Loop Gain (large signal)	A_{OL}	90	110	—	dB	$V_{OUT} = 0.3V$ to $V_{DD} - 0.3V$, $V_{CM} = V_{SS}$
Output						
Maximum Output Voltage Swing	V_{OL} , V_{OH}	$V_{SS} + 35$	—	$V_{DD} - 35$	mV	$R_L = 10$ k Ω , 0.5V Input Overdrive
Output Short-Circuit Current	I_{SC}	—	± 6	—	mA	$V_{DD} = 1.8V$
	I_{SC}	—	± 23	—	mA	$V_{DD} = 5.5V$
Power Supply						
Supply Voltage	V_{DD}	1.8	—	5.5	V	
Quiescent Current per Amplifier	I_Q	30	50	70	μA	$I_O = 0$, $V_{CM} = V_{DD} - 0.5V$

Note 1: The SC-70 package is only tested at $+25^{\circ}C$.

MCP6241/1R/1U/2/4

AC ELECTRICAL CHARACTERISTICS

Electrical Characteristics: Unless otherwise indicated, $T_A = +25^\circ\text{C}$, $V_{DD} = +1.8$ to 5.5V , $V_{SS} = \text{GND}$, $V_{CM} = V_{DD}/2$, $V_{OUT} \approx V_{DD}/2$, $R_L = 10\text{ k}\Omega$ to $V_{DD}/2$ and $C_L = 60\text{ pF}$.

Parameters	Sym	Min	Typ	Max	Units	Conditions
AC Response						
Gain Bandwidth Product	GBWP	—	550	—	kHz	
Phase Margin	PM	—	68	—	°	$G = +1\text{ V/V}$
Slew Rate	SR	—	0.30	—	$\text{V}/\mu\text{s}$	
Noise						
Input Noise Voltage	E_{ni}	—	10	—	$\mu\text{V}_{\text{P-P}}$	$f = 0.1\text{ Hz to }10\text{ Hz}$
Input Noise Voltage Density	e_{ni}	—	45	—	$\text{nV}/\sqrt{\text{Hz}}$	$f = 1\text{ kHz}$
Input Noise Current Density	i_{ni}	—	0.6	—	$\text{fA}/\sqrt{\text{Hz}}$	$f = 1\text{ kHz}$

TEMPERATURE CHARACTERISTICS

Electrical Characteristics: Unless otherwise indicated, $V_{DD} = +1.8\text{V to }+5.5\text{V}$ and $V_{SS} = \text{GND}$.

Parameters	Sym	Min	Typ	Max	Units	Conditions
Temperature Ranges						
Extended Temperature Range	T_A	-40	—	+125	°C	
Operating Temperature Range	T_A	-40	—	+125	°C	(Note)
Storage Temperature Range	T_A	-65	—	+150	°C	
Thermal Package Resistances						
Thermal Resistance, 5L-SC70	θ_{JA}	—	331	—	°C/W	
Thermal Resistance, 5L-SOT-23	θ_{JA}	—	256	—	°C/W	
Thermal Resistance, 8L-DFN (2x3)	θ_{JA}	—	84.5	—	°C/W	
Thermal Resistance, 8L-MSOP	θ_{JA}	—	206	—	°C/W	
Thermal Resistance, 8L-PDIP	θ_{JA}	—	85	—	°C/W	
Thermal Resistance, 8L-SOIC	θ_{JA}	—	163	—	°C/W	
Thermal Resistance, 14L-PDIP	θ_{JA}	—	70	—	°C/W	
Thermal Resistance, 14L-SOIC	θ_{JA}	—	120	—	°C/W	
Thermal Resistance, 14L-TSSOP	θ_{JA}	—	100	—	°C/W	

Note: The internal Junction Temperature (T_J) must not exceed the Absolute Maximum specification of $+150^\circ\text{C}$.

1.1 Test Circuits

The test circuits used for the DC and AC tests are shown in Figure 1-1 and Figure 1-2. The bypass capacitors are laid out according to the rules discussed in Section 4.6 “PCB Surface Leakage”.

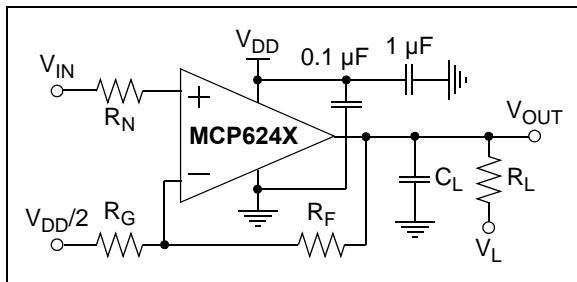

FIGURE 1-1: AC and DC Test Circuit for Most Non-Inverting Gain Conditions.

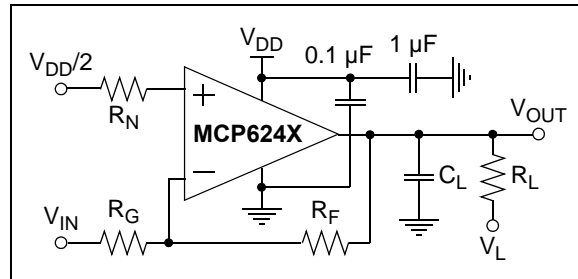

FIGURE 1-2: AC and DC Test Circuit for Most Inverting Gain Conditions.

2.0 TYPICAL PERFORMANCE CURVES

Note: The graphs and tables provided following this note are a statistical summary based on a limited number of samples and are provided for informational purposes only. The performance characteristics listed herein are not tested or guaranteed. In some graphs or tables, the data presented may be outside the specified operating range (e.g., outside specified power supply range) and therefore outside the warranted range.

Note: Unless otherwise indicated, $T_A = +25^\circ\text{C}$, $V_{DD} = +1.8\text{V to } +5.5\text{V}$, $V_{SS} = \text{GND}$, $V_{CM} = V_{DD}/2$, $V_{OUT} \approx V_{DD}/2$, $R_L = 100\text{ k}\Omega$ to $V_{DD}/2$ and $C_L = 60\text{ pF}$.



FIGURE 2-1: Input Offset Voltage.

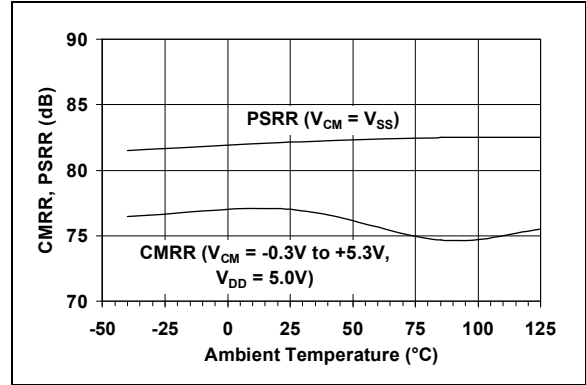

FIGURE 2-4: CMRR, PSRR vs. Ambient Temperature.



FIGURE 2-2: PSRR, CMRR vs. Frequency.

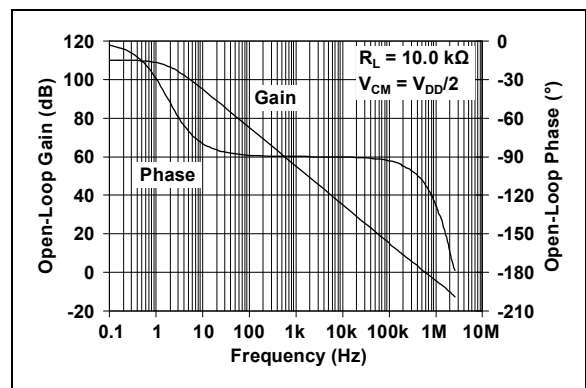

FIGURE 2-5: Open-Loop Gain, Phase vs. Frequency.

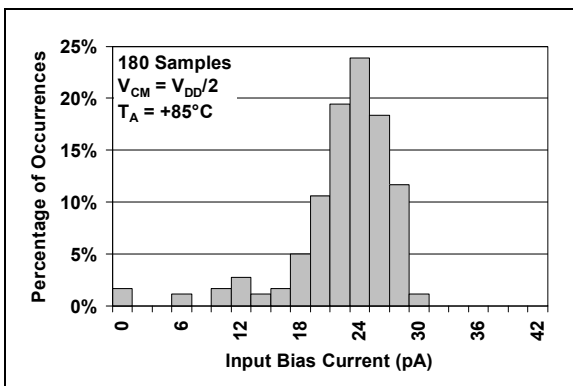

FIGURE 2-3: Input Bias Current at $+85^\circ\text{C}$.

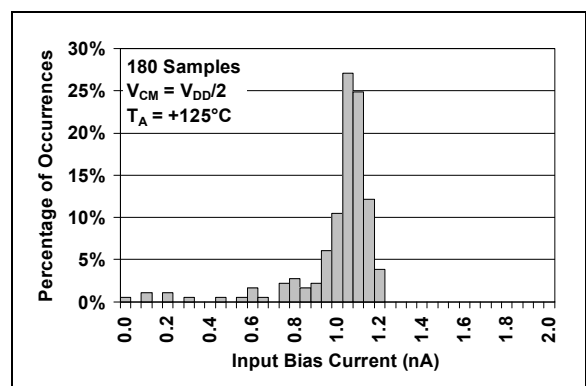

FIGURE 2-6: Input Bias Current at $+125^\circ\text{C}$.

MCP6241/1R/1U/2/4

Note: Unless otherwise indicated, $T_A = +25^\circ\text{C}$, $V_{DD} = +1.8\text{V}$ to $+5.5\text{V}$, $V_{SS} = \text{GND}$, $V_{CM} = V_{DD}/2$, $V_{OUT} \approx V_{DD}/2$, $R_L = 100\text{ k}\Omega$ to $V_{DD}/2$ and $C_L = 60\text{ pF}$.



FIGURE 2-7: Input Noise Voltage Density vs. Frequency.

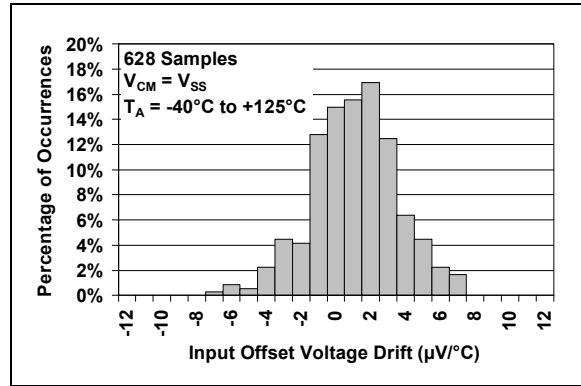

FIGURE 2-10: Input Offset Voltage Drift.

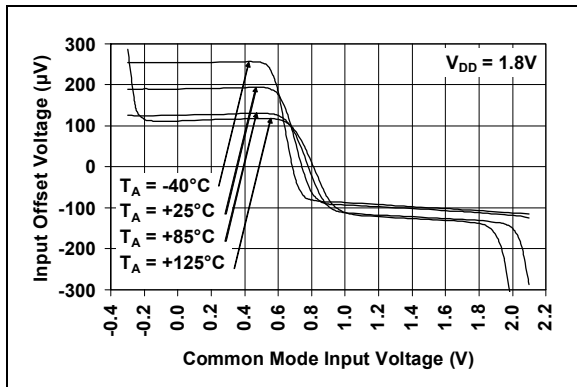

FIGURE 2-8: Input Offset Voltage vs. Common Mode Input Voltage at $V_{DD} = 1.8\text{V}$.

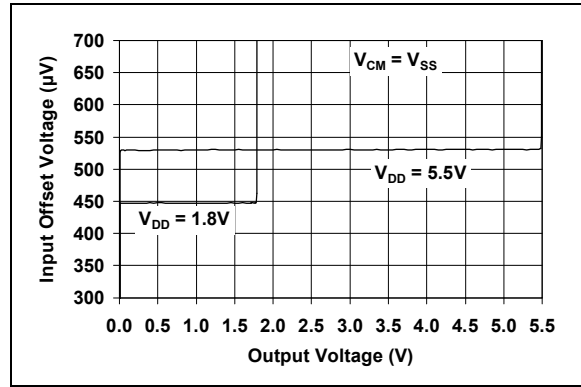

FIGURE 2-11: Input Offset Voltage vs. Output Voltage.

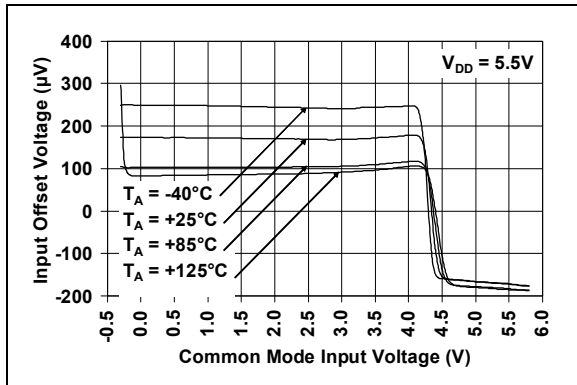

FIGURE 2-9: Input Offset Voltage vs. Common Mode Input Voltage at $V_{DD} = 5.5\text{V}$.

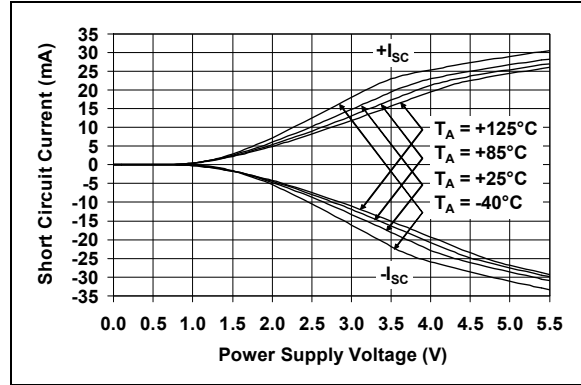

FIGURE 2-12: Output Short-Circuit Current vs. Ambient Temperature.

MCP6241/1R/1U/2/4

Note: Unless otherwise indicated, $T_A = +25^\circ\text{C}$, $V_{DD} = +1.8\text{V}$ to $+5.5\text{V}$, $V_{SS} = \text{GND}$, $V_{CM} = V_{DD}/2$, $V_{OUT} \approx V_{DD}/2$, $R_L = 100\text{ k}\Omega$ to $V_{DD}/2$ and $C_L = 60\text{ pF}$.



FIGURE 2-13: Slew Rate vs. Ambient Temperature.



FIGURE 2-16: Small-Signal, Non-Inverting Pulse Response.



FIGURE 2-14: Output Voltage Headroom vs. Output Current Magnitude.



FIGURE 2-17: Large-Signal, Non-Inverting Pulse Response.



FIGURE 2-15: Maximum Output Voltage Swing vs. Frequency.



FIGURE 2-18: Quiescent Current vs. Power Supply Voltage.

MCP6241/1R/1U/2/4

Note: Unless otherwise indicated, $T_A = +25^\circ\text{C}$, $V_{DD} = +1.8\text{V}$ to $+5.5\text{V}$, $V_{SS} = \text{GND}$, $V_{CM} = V_{DD}/2$, $V_{OUT} \approx V_{DD}/2$, $R_L = 100\text{ k}\Omega$ to $V_{DD}/2$ and $C_L = 60\text{ pF}$.



FIGURE 2-19: Measured Input Current vs. Input Voltage (below V_{SS}).

3.0 PIN DESCRIPTIONS

Descriptions of the pins are listed in [Table 3-1](#) (single op amps) and [Table 3-2](#) (dual and quad op amps).

TABLE 3-1: PIN FUNCTION TABLE FOR SINGLE OP AMPS

MCP6241			MCP6241R	MCP6241U	Symbol	Description
DFN	MSOP, PDIP, SOIC	SOT-23-5	SOT-23-5	SOT-23-5, SC-70		
6	6	1	1	4	V_{OUT}	Analog Output
2	2	4	4	3	V_{IN-}	Inverting Input
3	3	3	3	1	V_{IN+}	Non-inverting Input
7	7	5	2	5	V_{DD}	Positive Power Supply
4	4	2	5	2	V_{SS}	Negative Power Supply
1, 5, 8	1, 5, 8	—	—	—	NC	No Internal Connection
9	—	—	—	—	EP	Exposed Thermal Pad (EP); must be connected to V_{SS} .

TABLE 3-2: PIN FUNCTION TABLE FOR DUAL AND QUAD OP AMPS

MCP6242	MCP6244	Symbol	Description
MSOP, PDIP, SOIC	PDIP, SOIC, TSSOP		
1	1	V_{OUTA}	Analog Output (op amp A)
2	2	V_{INA-}	Inverting Input (op amp A)
3	3	V_{INA+}	Non-inverting Input (op amp A)
8	4	V_{DD}	Positive Power Supply
5	5	V_{INB+}	Non-inverting Input (op amp B)
6	6	V_{INB-}	Inverting Input (op amp B)
7	7	V_{OUTB}	Analog Output (op amp B)
—	8	V_{OUTC}	Analog Output (op amp C)
—	9	V_{INC-}	Inverting Input (op amp C)
—	10	V_{INC+}	Non-inverting Input (op amp C)
4	11	V_{SS}	Negative Power Supply
—	12	V_{IND+}	Non-inverting Input (op amp D)
—	13	V_{IND-}	Inverting Input (op amp D)
—	14	V_{OUTD}	Analog Output (op amp D)

3.1 Analog Outputs

The output pins are low-impedance voltage sources.

3.2 Analog Inputs

The non-inverting and inverting inputs are high-impedance CMOS inputs with low bias currents.

3.3 Power Supply (V_{SS} and V_{DD})

The positive power supply (V_{DD}) is 1.8V to 5.5V higher than the negative power supply (V_{SS}). For normal operation, the other pins are between V_{SS} and V_{DD} .

Typically, these parts are used in a single (positive) supply configuration. In this case, V_{SS} is connected to ground and V_{DD} is connected to the supply. V_{DD} will need bypass capacitors.

3.4 Exposed Thermal Pad (EP)

There is an internal electrical connection between the Exposed Thermal Pad (EP) and the V_{SS} pin; they must be connected to the same potential on the Printed Circuit Board (PCB).

MCP6241/1R/1U/2/4

NOTES:

4.0 APPLICATION INFORMATION

The MCP6241/1R/1U/2/4 family of op amps is manufactured using Microchip's state-of-the-art CMOS process and is specifically designed for low-power and general-purpose applications. The low supply voltage, low quiescent current and wide bandwidth makes the MCP6241/1R/1U/2/4 ideal for battery-powered applications.

4.1 Rail-to-Rail Inputs

4.1.1 PHASE REVERSAL

The MCP6241/1R/1U/2/4 op amp is designed to prevent phase reversal when the input pins exceed the supply voltages. Figure 4-1 shows the input voltage exceeding the supply voltage without any phase reversal.

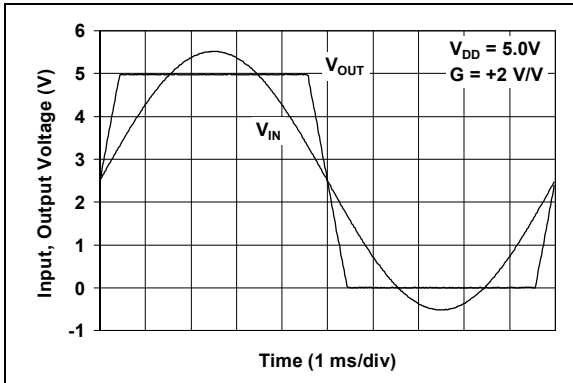

FIGURE 4-1: The MCP6241/1R/1U/2/4 Show No Phase Reversal.

4.1.2 INPUT VOLTAGE AND CURRENT LIMITS

The ESD protection on the inputs can be depicted as shown in Figure 4-2. This structure was chosen to protect the input transistors, and to minimize input bias current (I_B). The input ESD diodes clamp the inputs when they try to go more than one diode drop below V_{SS} . They also clamp any voltages that go too far above V_{DD} ; their breakdown voltage is high enough to allow normal operation, and low enough to bypass quick ESD events within the specified limits.



FIGURE 4-2: Simplified Analog Input ESD Structures.

In order to prevent damage and/or improper operation of these op amps, the circuit they are in must limit the currents and voltages at the V_{IN+} and V_{IN-} pins (see **Absolute Maximum Ratings** † at the beginning of **Section 1.0 “Electrical Characteristics”**). Figure 4-3 shows the recommended approach to protecting these inputs. The internal ESD diodes prevent the input pins (V_{IN+} and V_{IN-}) from going too far below ground, and the resistors R_1 and R_2 limit the possible current drawn out of the input pins. Diodes D_1 and D_2 prevent the input pins (V_{IN+} and V_{IN-}) from going too far above V_{DD} , and dump any currents onto V_{DD} . When implemented as shown, resistors R_1 and R_2 also limit the current through D_1 and D_2 .

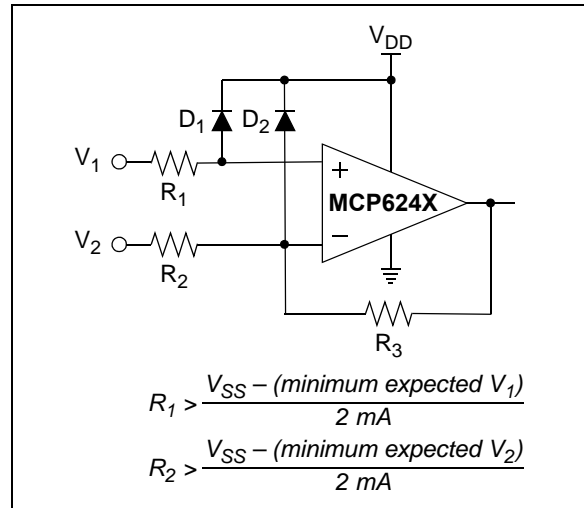

FIGURE 4-3: Protecting the Analog Inputs.

It is also possible to connect the diodes to the left of resistors R_1 and R_2 . In this case, current through the diodes D_1 and D_2 needs to be limited by some other mechanism. The resistors then serve as in-rush current limiters; the DC current into the input pins (V_{IN+} and V_{IN-}) should be very small.

MCP6241/1R/1U/2/4

A significant amount of current can flow out of the inputs when the common mode voltage (V_{CM}) is below ground (V_{SS}); see Figure 2-19. Applications that are high impedance may need to limit the useable voltage range.

4.1.3 NORMAL OPERATION

The input stage of the MCP6241/1R/1U/2/4 op amps use two differential CMOS input stages in parallel. One operates at low common mode input voltage (V_{CM}), while the other operates at high V_{CM} . With this topology, the device operates with V_{CM} up to 0.3V above V_{DD} and 0.3V below V_{SS} .

4.2 Rail-to-Rail Output

The output voltage range of the MCP6241/1R/1U/2/4 op amps is $V_{DD} - 35\text{ mV}$ (maximum) and $V_{SS} + 35\text{ mV}$ (minimum) when $R_L = 10\text{ k}\Omega$ is connected to $V_{DD}/2$ and $V_{DD} = 5.5\text{V}$. Refer to Figure 2-14 for more information.

4.3 Capacitive Loads

Driving large capacitive loads can cause stability problems for voltage-feedback op amps. As the load capacitance increases, the feedback loop's phase margin decreases and the closed-loop bandwidth is reduced. This produces gain peaking in the frequency response, with overshoot and ringing in the step response. A unity-gain buffer ($G = +1$) is the most sensitive to capacitive loads, but all gains show the same general behavior.

When driving large capacitive loads with these op amps (e.g., $> 70\text{ pF}$ when $G = +1$), a small series resistor at the output (R_{ISO} in Figure 4-4) improves the feedback loop's phase margin (stability) by making the output load resistive at higher frequencies. The bandwidth will be generally lower than the bandwidth with no capacitive load.

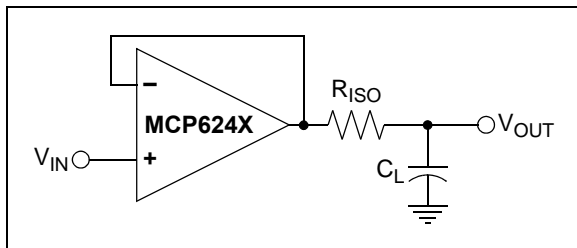

FIGURE 4-4: Output Resistor, R_{ISO} stabilizes large capacitive loads.

Figure 4-5 gives recommended R_{ISO} values for different capacitive loads and gains. The x-axis is the normalized load capacitance (C_L/G_N), where G_N is the circuit's noise gain. For non-inverting gains, G_N and the signal gain are equal. For inverting gains, G_N is $1 + |\text{Signal Gain}|$ (e.g., -1 V/V gives $G_N = +2\text{ V/V}$).



FIGURE 4-5: Recommended R_{ISO} Values for Capacitive Loads.

After selecting R_{ISO} for your circuit, double-check the resulting frequency response peaking and step response overshoot. Evaluation on the bench and simulations with the MCP6241/1R/1U/2/4 SPICE macro model are very helpful. Modify R_{ISO} 's value until the response is reasonable.

4.4 Supply Bypass

With this op amp, the power supply pin (V_{DD} for single-supply) should have a local bypass capacitor (i.e., $0.01\text{ }\mu\text{F}$ to $0.1\text{ }\mu\text{F}$) within 2 mm for good high-frequency performance. It can use a bulk capacitor (i.e., $1\text{ }\mu\text{F}$ or larger) within 100 mm to provide large, slow currents. This bulk capacitor can be shared with other nearby analog parts.

4.5 Unused Op Amps

An unused op amp in a quad package (MCP6244) should be configured as shown in Figure 4-6. Both circuits prevent the output from toggling and causing crosstalk. Circuit A can use any reference voltage between the supplies, provides a buffered DC voltage, and minimizes the supply current draw of the unused op amp. Circuit B minimizes the number of components, but may draw a little more supply current for the unused op amp.



FIGURE 4-6: Unused Op Amps.

4.6 PCB Surface Leakage

In applications where low input bias current is critical, PCB (printed circuit board) surface leakage effects need to be considered. Surface leakage is caused by humidity, dust or other contamination on the board. Under low humidity conditions, a typical resistance between nearby traces is $10^{12}\Omega$. A 5V difference would cause 5 pA of current to flow, which is greater than the MCP6241/1R/1U/2/4 family's bias current at 25°C (1 pA, typical).

The easiest way to reduce surface leakage is to use a guard ring around sensitive pins (or traces). The guard ring is biased at the same voltage as the sensitive pin. An example of this type of layout is shown in Figure 4-7.



FIGURE 4-7: Example Guard Ring Layout for Inverting Gain.

1. Non-inverting Gain and Unity-Gain Buffer:
 - a. Connect the non-inverting pin (V_{IN+}) to the input with a wire that does not touch the PCB surface.
 - b. Connect the guard ring to the inverting input pin (V_{IN-}). This biases the guard ring to the common mode input voltage.
2. Inverting Gain and Transimpedance Amplifiers (convert current to voltage, such as photo detectors):
 - a. Connect the guard ring to the non-inverting input pin (V_{IN+}). This biases the guard ring to the same reference voltage as the op amp (e.g., $V_{DD}/2$ or ground).
 - b. Connect the inverting pin (V_{IN-}) to the input with a wire that does not touch the PCB surface.

4.7 Application Circuits

4.7.1 MATCHING THE IMPEDANCE AT THE INPUTS

To minimize the effect of offset voltage in an amplifier circuit, the impedances at the inverting and non-inverting inputs need to be matched. This is done by choosing the circuit resistor values so that the total resistance at each input is the same. Figure 4-8 shows a summing amplifier circuit.



FIGURE 4-8: Summing Amplifier Circuit.

To match the inputs, set all voltage sources to ground and calculate the total resistance at the input nodes. In this summing amplifier circuit, the resistance at the inverting input is calculated by setting V_{IN1} , V_{IN2} and V_{OUT} to ground. In this case, R_{G1} , R_{G2} and R_F are in parallel. The total resistance at the inverting input is:

$$R_{VIN-} = \frac{1}{\left(\frac{1}{R_{G1}} + \frac{1}{R_{G2}} + \frac{1}{R_F}\right)}$$

Where:

R_{VIN-} = total resistance at the inverting input

At the non-inverting input, V_{DD} is the only voltage source. When V_{DD} is set to ground, both R_X and R_Y are in parallel. The total resistance at the non-inverting input is:

$$R_{VIN+} = \frac{1}{\left(\frac{1}{R_X} + \frac{1}{R_Y}\right)} + R_Z$$

Where:

R_{VIN+} = total resistance at the inverting input

To minimize offset voltage and increase circuit accuracy, the resistor values need to meet the condition:

$$R_{VIN+} = R_{VIN-}$$

MCP6241/1R/1U/2/4

4.7.2 COMPENSATING FOR THE PARASITIC CAPACITANCE

In analog circuit design, the PCB parasitic capacitance can compromise the circuit behavior; Figure 4-9 shows a typical scenario. If the input of an amplifier sees parasitic capacitance of several picofarad (C_{PARA} , which includes the common mode capacitance of 6 pF, typical) and large R_F and R_G , the frequency response of the circuit will include a zero. This parasitic zero introduces gain peaking and can cause circuit instability.



FIGURE 4-9: Effect of Parasitic Capacitance at the Input.

One solution is to use smaller resistor values to push the zero to a higher frequency. Another solution is to compensate by introducing a pole at the point at which the zero occurs. This can be done by adding C_F in parallel with the feedback resistor (R_F). C_F needs to be selected so that the ratio $C_{PARA}:C_F$ is equal to the ratio of $R_F:R_G$.

5.0 DESIGN AIDS

Microchip provides the basic design tools needed for the MCP6241/1R/1U/2/4 family of op amps.

5.1 SPICE Macro Model

The latest SPICE macro model for the MCP6241/1R/1U/2/4 op amps is available on the Microchip web site at www.microchip.com. This model is intended to be an initial design tool that works well in the op amp's linear region of operation over the temperature range. See the model file for information on its capabilities.

Bench testing is a very important part of any design and cannot be replaced with simulations. Also, simulation results using this macro model need to be validated by comparing them to the data sheet specifications and characteristic curves.

5.2 Mindi™ Circuit Designer & Simulator

Microchip's Mindi™ Circuit Designer & Simulator aids in the design of various circuits useful for active filter, amplifier and power-management applications. It is a free online circuit designer & simulator available from the Microchip web site at www.microchip.com/mindi. This interactive circuit designer & simulator enables designers to quickly generate circuit diagrams, simulate circuits. Circuits developed using the Mindi Circuit Designer & Simulator can be downloaded to a personal computer or workstation.

5.3 Microchip Advanced Part Selector (MAPS)

MAPS is a software tool that helps semiconductor professionals efficiently identify Microchip devices that fit a particular design requirement. Available at no cost from the Microchip web site at www.microchip.com/maps, the MAPS is an overall selection tool for Microchip's product portfolio that includes Analog, Memory, MCUs and DSCs. Using this tool you can define a filter to sort features for a parametric search of devices and export side-by-side technical comparison reports. Helpful links are also provided for Data sheets, Purchase, and Sampling of Microchip parts.

5.4 Analog Demonstration and Evaluation Boards

Microchip offers a broad spectrum of Analog Demonstration and Evaluation Boards that are designed to help you achieve faster time to market. For a complete listing of these boards and their corresponding user's guides and technical information, visit the Microchip web site at www.microchip.com/analogtools.

Two of our boards that are especially useful are:

- **P/N SOIC8EV:** *8-Pin SOIC/MSOP/TSSOP/DIP Evaluation Board*
- **P/N SOIC14EV:** *14-Pin SOIC/TSSOP/DIP Evaluation Board*

5.5 Application Notes

The following Microchip Application Notes are available on the Microchip web site at www.microchip.com/appnotes and are recommended as supplemental reference resources.

ADN003: *"Select the Right Operational Amplifier for your Filtering Circuits"*, DS21821

AN722: *"Operational Amplifier Topologies and DC Specifications"*, DS00722

AN723: *"Operational Amplifier AC Specifications and Applications"*, DS00723

AN884: *"Driving Capacitive Loads With Op Amps"*, DS00884

AN990: *"Analog Sensor Conditioning Circuits – An Overview"*, DS00990

These application notes and others are listed in the design guide:

"Signal Chain Design Guide", DS21825

MCP6241/1R/1U/2/4

NOTES:

6.0 PACKAGING INFORMATION

6.1 Package Marking Information

5-Lead SC-70 (MCP6241U Only)

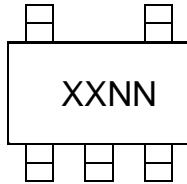

Example:

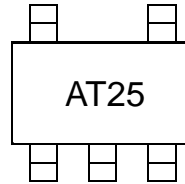

5-Lead SOT-23 (MCP6241, MCP6241R, MCP6241U)

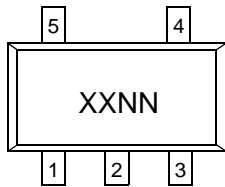

Device	Code
MCP6241	BQNN
MCP6241R	BRNN
MCP6241U	BSNN

Note: Applies to 5-Lead SOT-23.

Example:

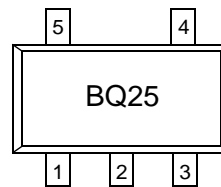

8-Lead DFN (2x3) (MCP6241 Only)

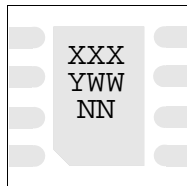

Example:

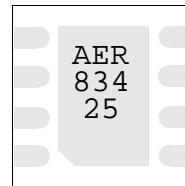

8-Lead MSOP

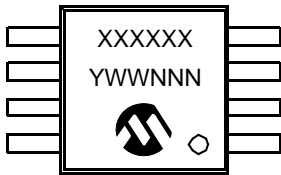

Example:



8-Lead PDIP (300 mil)

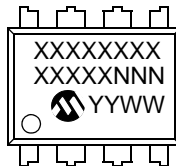

Example:

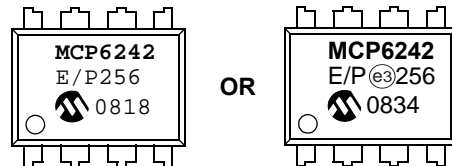

Legend:	XX...X	Customer-specific information
	Y	Year code (last digit of calendar year)
	YY	Year code (last 2 digits of calendar year)
	WW	Week code (week of January 1 is week '01')
	NNN	Alphanumeric traceability code
	(e3)	Pb-free JEDEC designator for Matte Tin (Sn)
	*	This package is Pb-free. The Pb-free JEDEC designator (e3) can be found on the outer packaging for this package.

Note: In the event the full Microchip part number cannot be marked on one line, it will be carried over to the next line, thus limiting the number of available characters for customer-specific information.

MCP6241/1R/1U/2/4

Package Marking Information (Continued)

8-Lead SOIC (150 mil)

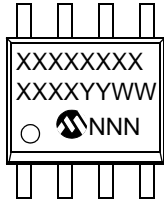

Example:

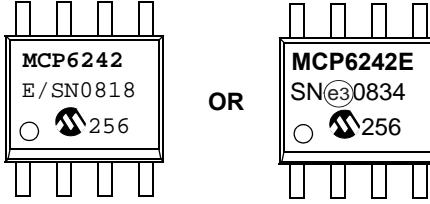

14-Lead PDIP (300 mil) (MCP6244)

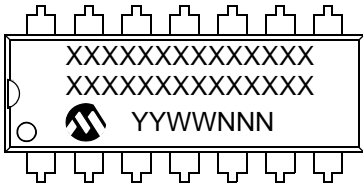

Example:

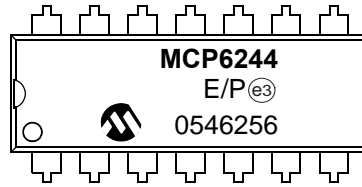

14-Lead SOIC (150 mil) (MCP6244)

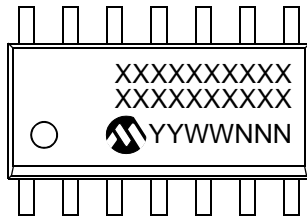

Example:

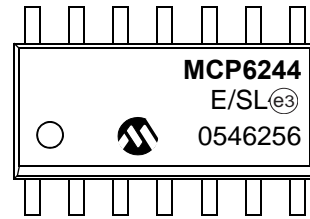

14-Lead TSSOP (MCP6244)

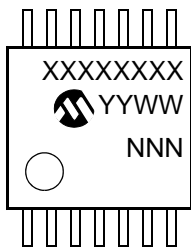

Example:

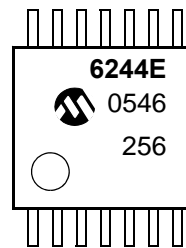

5-Lead Plastic Small Outline Transistor (LT) [SC70]

Note: For the most current package drawings, please see the Microchip Packaging Specification located at <http://www.microchip.com/packaging>



Dimension Limits	Units	MILLIMETERS		
		MIN	NOM	MAX
Number of Pins	N	5		
Pitch	e	0.65 BSC		
Overall Height	A	0.80	–	1.10
Molded Package Thickness	A2	0.80	–	1.00
Standoff	A1	0.00	–	0.10
Overall Width	E	1.80	2.10	2.40
Molded Package Width	E1	1.15	1.25	1.35
Overall Length	D	1.80	2.00	2.25
Foot Length	L	0.10	0.20	0.46
Lead Thickness	c	0.08	–	0.26
Lead Width	b	0.15	–	0.40

Notes:

- Dimensions D and E1 do not include mold flash or protrusions. Mold flash or protrusions shall not exceed 0.127 mm per side.
- Dimensioning and tolerancing per ASME Y14.5M.
BSC: Basic Dimension. Theoretically exact value shown without tolerances.

Microchip Technology Drawing C04-061B

MCP6241/1R/1U/2/4

5-Lead Plastic Small Outline Transistor (LT) [SC70]

Note: For the most current package drawings, please see the Microchip Packaging Specification located at <http://www.microchip.com/packaging>

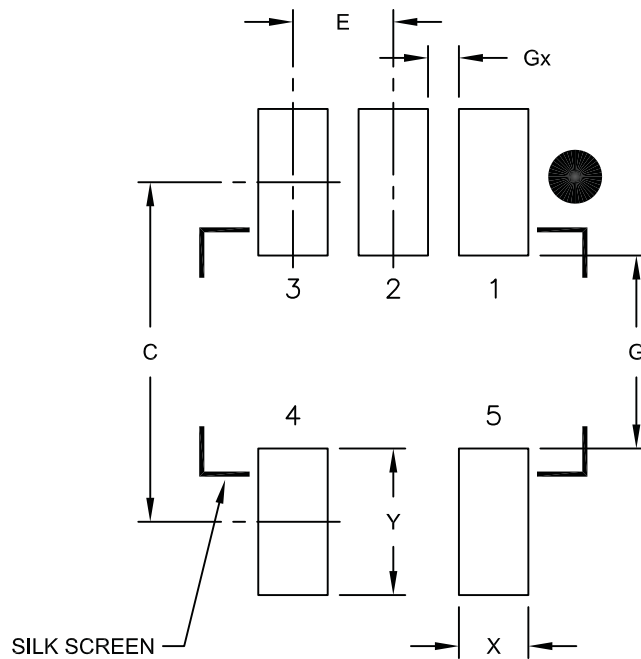

RECOMMENDED LAND PATTERN

Dimension Limits	Units	MILLIMETERS		
		MIN	NOM	MAX
Contact Pitch	E	0.65 BSC		
Contact Pad Spacing	C		2.20	
Contact Pad Width	X			0.45
Contact Pad Length	Y			0.95
Distance Between Pads	G	1.25		
Distance Between Pads	Gx	0.20		

Notes:

1. Dimensioning and tolerancing per ASME Y14.5M

BSC: Basic Dimension. Theoretically exact value shown without tolerances.

Microchip Technology Drawing No. C04-2061A

5-Lead Plastic Small Outline Transistor (OT) [SOT-23]

Note: For the most current package drawings, please see the Microchip Packaging Specification located at <http://www.microchip.com/packaging>



Dimension Limits	Units	MILLIMETERS		
		MIN	NOM	MAX
Number of Pins	N	5		
Lead Pitch	e	0.95 BSC		
Outside Lead Pitch	e1	1.90 BSC		
Overall Height	A	0.90	–	1.45
Molded Package Thickness	A2	0.89	–	1.30
Standoff	A1	0.00	–	0.15
Overall Width	E	2.20	–	3.20
Molded Package Width	E1	1.30	–	1.80
Overall Length	D	2.70	–	3.10
Foot Length	L	0.10	–	0.60
Footprint	L1	0.35	–	0.80
Foot Angle	ϕ	0°	–	30°
Lead Thickness	c	0.08	–	0.26
Lead Width	b	0.20	–	0.51

Notes:

- Dimensions D and E1 do not include mold flash or protrusions. Mold flash or protrusions shall not exceed 0.127 mm per side.
- Dimensioning and tolerancing per ASME Y14.5M.

BSC: Basic Dimension. Theoretically exact value shown without tolerances.

Microchip Technology Drawing C04-091B

MCP6241/1R/1U/2/4

8-Lead Plastic Dual Flat, No Lead Package (MC) – 2x3x0.9 mm Body [DFN]

Note: For the most current package drawings, please see the Microchip Packaging Specification located at <http://www.microchip.com/packaging>

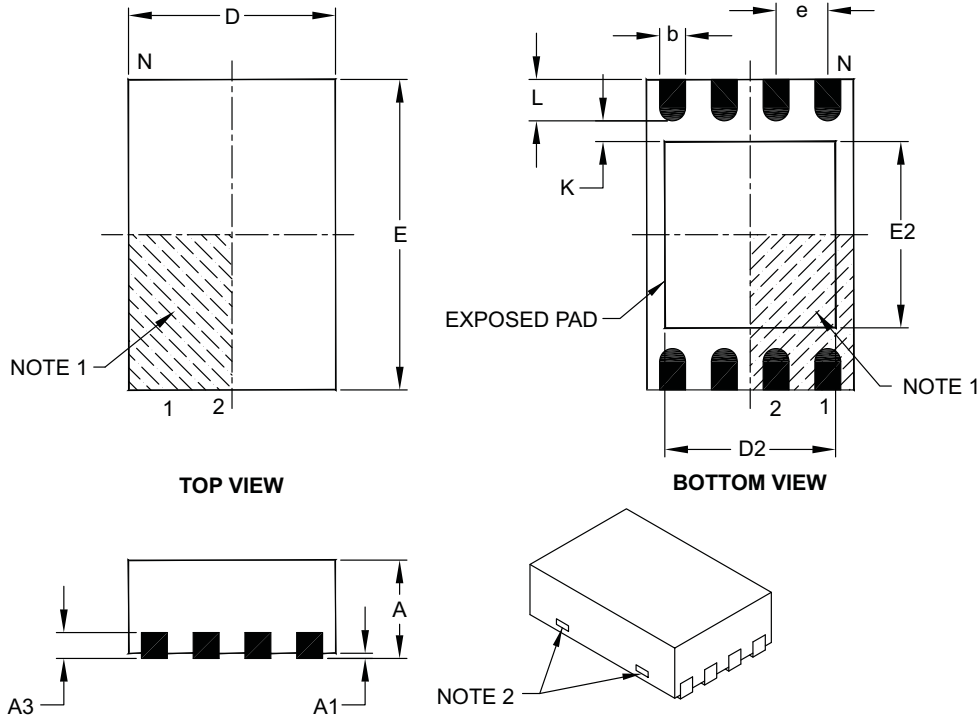

Dimension Limits	Units	MILLIMETERS		
		MIN	NOM	MAX
Number of Pins	N	8		
Pitch	e	0.50 BSC		
Overall Height	A	0.80	0.90	1.00
Standoff	A1	0.00	0.02	0.05
Contact Thickness	A3	0.20 REF		
Overall Length	D	2.00 BSC		
Overall Width	E	3.00 BSC		
Exposed Pad Length	D2	1.30	–	1.55
Exposed Pad Width	E2	1.50	–	1.75
Contact Width	b	0.20	0.25	0.30
Contact Length	L	0.30	0.40	0.50
Contact-to-Exposed Pad	K	0.20	–	–

Notes:

- Pin 1 visual index feature may vary, but must be located within the hatched area.
- Package may have one or more exposed tie bars at ends.
- Package is saw singulated.
- Dimensioning and tolerancing per ASME Y14.5M.

BSC: Basic Dimension. Theoretically exact value shown without tolerances.

REF: Reference Dimension, usually without tolerance, for information purposes only.

Microchip Technology Drawing C04-123C

8-Lead Plastic Dual Flat, No Lead Package (MC) – 2x3x0.9 mm Body [DFN]

Note: For the most current package drawings, please see the Microchip Packaging Specification located at <http://www.microchip.com/packaging>



RECOMMENDED LAND PATTERN

Dimension Limits	Units	MILLIMETERS		
		MIN	NOM	MAX
Contact Pitch	E	0.50 BSC		
Optional Center Pad Width	W2			1.45
Optional Center Pad Length	T2			1.75
Contact Pad Spacing	C1		2.90	
Contact Pad Width (X8)	X1			0.30
Contact Pad Length (X8)	Y1			0.75
Distance Between Pads	G	0.20		

Notes:

1. Dimensioning and tolerancing per ASME Y14.5M

BSC: Basic Dimension. Theoretically exact value shown without tolerances.

Microchip Technology Drawing No. C04-2123A

MCP6241/1R/1U/2/4

8-Lead Plastic Micro Small Outline Package (MS) [MSOP]

Note: For the most current package drawings, please see the Microchip Packaging Specification located at <http://www.microchip.com/packaging>



Dimension Limits	Units	MILLIMETERS		
		MIN	NOM	MAX
Number of Pins	N	8		
Pitch	e	0.65 BSC		
Overall Height	A	-	-	1.10
Molded Package Thickness	A2	0.75	0.85	0.95
Standoff	A1	0.00	-	0.15
Overall Width	E	4.90 BSC		
Molded Package Width	E1	3.00 BSC		
Overall Length	D	3.00 BSC		
Foot Length	L	0.40	0.60	0.80
Footprint	L1	0.95 REF		
Foot Angle	ϕ	0°	-	8°
Lead Thickness	c	0.08	-	0.23
Lead Width	b	0.22	-	0.40

Notes:

- Pin 1 visual index feature may vary, but must be located within the hatched area.
- Dimensions D and E1 do not include mold flash or protrusions. Mold flash or protrusions shall not exceed 0.15 mm per side.
- Dimensioning and tolerancing per ASME Y14.5M.

BSC: Basic Dimension. Theoretically exact value shown without tolerances.

REF: Reference Dimension, usually without tolerance, for information purposes only.

Microchip Technology Drawing C04-111B

8-Lead Plastic Dual In-Line (P) – 300 mil Body [PDIP]

Note: For the most current package drawings, please see the Microchip Packaging Specification located at <http://www.microchip.com/packaging>



Dimension Limits	Units	INCHES		
		MIN	NOM	MAX
Number of Pins	N	8		
Pitch	e	.100 BSC		
Top to Seating Plane	A	–	–	.210
Molded Package Thickness	A2	.115	.130	.195
Base to Seating Plane	A1	.015	–	–
Shoulder to Shoulder Width	E	.290	.310	.325
Molded Package Width	E1	.240	.250	.280
Overall Length	D	.348	.365	.400
Tip to Seating Plane	L	.115	.130	.150
Lead Thickness	c	.008	.010	.015
Upper Lead Width	b1	.040	.060	.070
Lower Lead Width	b	.014	.018	.022
Overall Row Spacing §	eB	–	–	.430

Notes:

- Pin 1 visual index feature may vary, but must be located with the hatched area.
- § Significant Characteristic.
- Dimensions D and E1 do not include mold flash or protrusions. Mold flash or protrusions shall not exceed .010" per side.
- Dimensioning and tolerancing per ASME Y14.5M.

BSC: Basic Dimension. Theoretically exact value shown without tolerances.

Microchip Technology Drawing C04-018B

MCP6241/1R/1U/2/4

8-Lead Plastic Small Outline (SN) – Narrow, 3.90 mm Body [SOIC]

Note: For the most current package drawings, please see the Microchip Packaging Specification located at <http://www.microchip.com/packaging>



Dimension Limits	Units	MILLIMETERS		
		MIN	NOM	MAX
Number of Pins	N	8		
Pitch	e	1.27 BSC		
Overall Height	A	–	–	1.75
Molded Package Thickness	A2	1.25	–	–
Standoff §	A1	0.10	–	0.25
Overall Width	E	6.00 BSC		
Molded Package Width	E1	3.90 BSC		
Overall Length	D	4.90 BSC		
Chamfer (optional)	h	0.25	–	0.50
Foot Length	L	0.40	–	1.27
Footprint	L1	1.04 REF		
Foot Angle	ϕ	0°	–	8°
Lead Thickness	c	0.17	–	0.25
Lead Width	b	0.31	–	0.51
Mold Draft Angle Top	α	5°	–	15°
Mold Draft Angle Bottom	β	5°	–	15°

Notes:

1. Pin 1 visual index feature may vary, but must be located within the hatched area.
2. § Significant Characteristic.
3. Dimensions D and E1 do not include mold flash or protrusions. Mold flash or protrusions shall not exceed 0.15 mm per side.
4. Dimensioning and tolerancing per ASME Y14.5M.

BSC: Basic Dimension. Theoretically exact value shown without tolerances.

REF: Reference Dimension, usually without tolerance, for information purposes only.

Microchip Technology Drawing C04-057B

8-Lead Plastic Small Outline (SN) – Narrow, 3.90 mm Body [SOIC]

Note: For the most current package drawings, please see the Microchip Packaging Specification located at <http://www.microchip.com/packaging>



RECOMMENDED LAND PATTERN

Dimension Limits	Units	MILLIMETERS		
		MIN	NOM	MAX
Contact Pitch	E	1.27 BSC		
Contact Pad Spacing	C		5.40	
Contact Pad Width (X8)	X1			0.60
Contact Pad Length (X8)	Y1			1.55

Notes:

1. Dimensioning and tolerancing per ASME Y14.5M

BSC: Basic Dimension. Theoretically exact value shown without tolerances.

Microchip Technology Drawing No. C04-2057A

MCP6241/1R/1U/2/4

14-Lead Plastic Dual In-Line (P) – 300 mil Body [PDIP]

Note: For the most current package drawings, please see the Microchip Packaging Specification located at <http://www.microchip.com/packaging>



	Units	INCHES		
		MIN	NOM	MAX
Number of Pins	N	14		
Pitch	e	.100 BSC		
Top to Seating Plane	A	–	–	.210
Molded Package Thickness	A2	.115	.130	.195
Base to Seating Plane	A1	.015	–	–
Shoulder to Shoulder Width	E	.290	.310	.325
Molded Package Width	E1	.240	.250	.280
Overall Length	D	.735	.750	.775
Tip to Seating Plane	L	.115	.130	.150
Lead Thickness	c	.008	.010	.015
Upper Lead Width	b1	.045	.060	.070
Lower Lead Width	b	.014	.018	.022
Overall Row Spacing §	eB	–	–	.430

Notes:

- Pin 1 visual index feature may vary, but must be located with the hatched area.
- § Significant Characteristic.
- Dimensions D and E1 do not include mold flash or protrusions. Mold flash or protrusions shall not exceed .010" per side.
- Dimensioning and tolerancing per ASME Y14.5M.

BSC: Basic Dimension. Theoretically exact value shown without tolerances.

Microchip Technology Drawing C04-005B

14-Lead Plastic Small Outline (SL) – Narrow, 3.90 mm Body [SOIC]

Note: For the most current package drawings, please see the Microchip Packaging Specification located at <http://www.microchip.com/packaging>



Dimension Limits	Units	MILLIMETERS		
		MIN	NOM	MAX
Number of Pins	N	14		
Pitch	e	1.27 BSC		
Overall Height	A	–	–	1.75
Molded Package Thickness	A2	1.25	–	–
Standoff §	A1	0.10	–	0.25
Overall Width	E	6.00 BSC		
Molded Package Width	E1	3.90 BSC		
Overall Length	D	8.65 BSC		
Chamfer (optional)	h	0.25	–	0.50
Foot Length	L	0.40	–	1.27
Footprint	L1	1.04 REF		
Foot Angle	φ	0°	–	8°
Lead Thickness	c	0.17	–	0.25
Lead Width	b	0.31	–	0.51
Mold Draft Angle Top	α	5°	–	15°
Mold Draft Angle Bottom	β	5°	–	15°

Notes:

- Pin 1 visual index feature may vary, but must be located within the hatched area.
- § Significant Characteristic.
- Dimensions D and E1 do not include mold flash or protrusions. Mold flash or protrusions shall not exceed 0.15 mm per side.
- Dimensioning and tolerancing per ASME Y14.5M.

BSC: Basic Dimension. Theoretically exact value shown without tolerances.

REF: Reference Dimension, usually without tolerance, for information purposes only.

Microchip Technology Drawing C04-065B

MCP6241/1R/1U/2/4

14-Lead Plastic Small Outline (SL) - Narrow, 3.90 mm Body [SOIC]

Note: For the most current package drawings, please see the Microchip Packaging Specification located at <http://www.microchip.com/packaging>

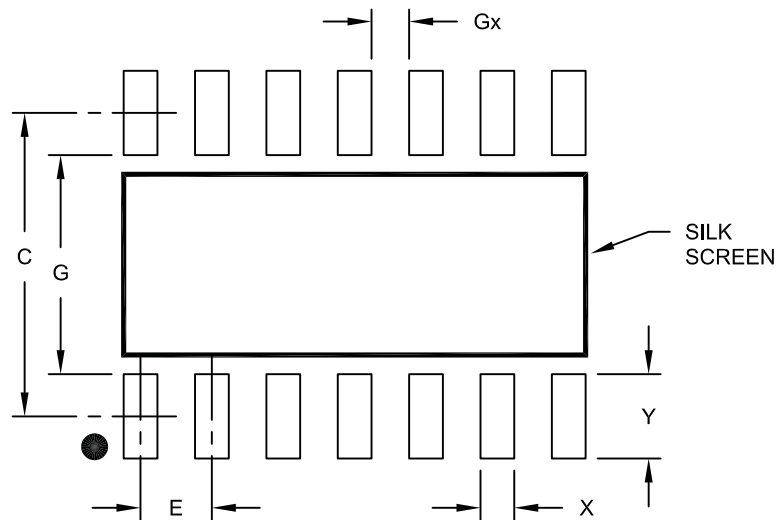

RECOMMENDED LAND PATTERN

Dimension Limits	Units	MILLIMETERS		
		MIN	NOM	MAX
Contact Pitch	E	1.27 BSC		
Contact Pad Spacing	C		5.40	
Contact Pad Width	X			0.60
Contact Pad Length	Y			1.50
Distance Between Pads	Gx	0.67		
Distance Between Pads	G	3.90		

Notes:

1. Dimensioning and tolerancing per ASME Y14.5M

BSC: Basic Dimension. Theoretically exact value shown without tolerances.

Microchip Technology Drawing No. C04-2065A

MCP6241/1R/1U/2/4

14-Lead Plastic Thin Shrink Small Outline (ST) – 4.4 mm Body [TSSOP]

Note: For the most current package drawings, please see the Microchip Packaging Specification located at <http://www.microchip.com/packaging>

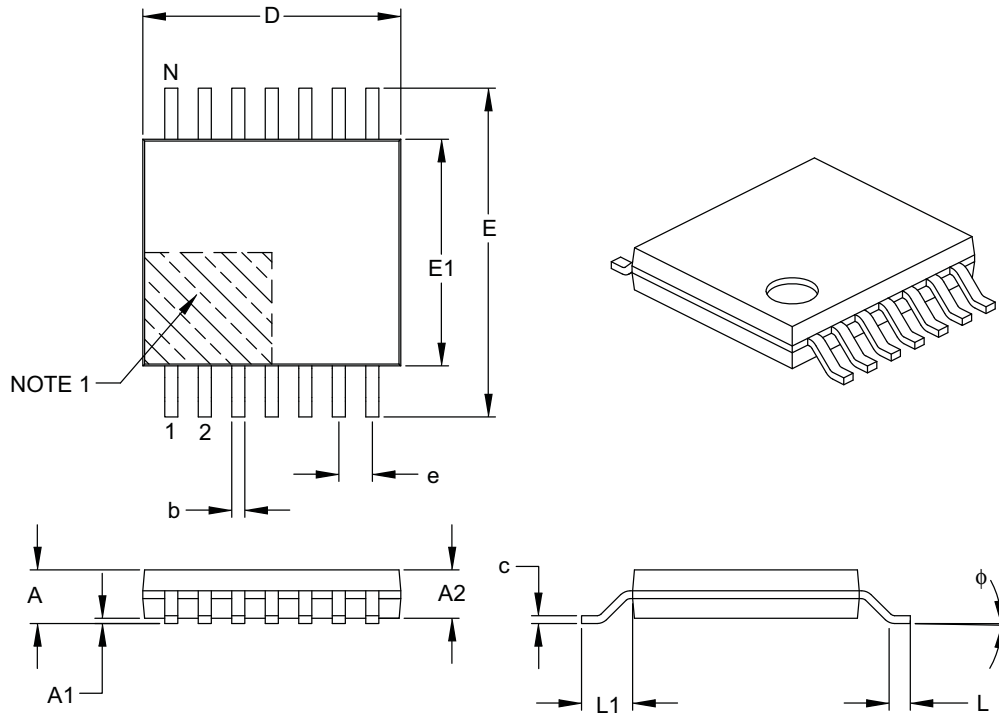

Dimension Limits	Units	MILLIMETERS		
		MIN	NOM	MAX
Number of Pins	N	14		
Pitch	e	0.65 BSC		
Overall Height	A	–	–	1.20
Molded Package Thickness	A2	0.80	1.00	1.05
Standoff	A1	0.05	–	0.15
Overall Width	E	6.40 BSC		
Molded Package Width	E1	4.30	4.40	4.50
Molded Package Length	D	4.90	5.00	5.10
Foot Length	L	0.45	0.60	0.75
Footprint	L1	1.00 REF		
Foot Angle	φ	0°	–	8°
Lead Thickness	c	0.09	–	0.20
Lead Width	b	0.19	–	0.30

Notes:

- Pin 1 visual index feature may vary, but must be located within the hatched area.
- Dimensions D and E1 do not include mold flash or protrusions. Mold flash or protrusions shall not exceed 0.15 mm per side.
- Dimensioning and tolerancing per ASME Y14.5M.

BSC: Basic Dimension. Theoretically exact value shown without tolerances.

REF: Reference Dimension, usually without tolerance, for information purposes only.

Microchip Technology Drawing C04-087B

MCP6241/1R/1U/2/4

NOTES:

APPENDIX A: REVISION HISTORY

Revision D (October 2008)

The following is the list of modifications:

1. Changed Heading "Available Tools" to "Design Aids".
2. **Design Aids:** Name change for Mindi Simulator Tool.
3. **Package Types:** Added DFN to MCP6231 Device.
4. **Absolute Maximum Ratings:** Numerous changes in this section.
5. Updated notes to **Section 1.0 "Electrical Characteristics"**.
6. Added [Figure 2-19](#).
7. Numerous changes to **Section 3.0 "Pin Descriptions"**.
8. Added **Section 4.1.1 "Phase Reversal"**, **Section 4.1.2 "Input Voltage and Current Limits"**, and **Section 4.1.3 "Normal Operation"**.
9. Replaced **Section 5.0 "Design Aids"** with additional information.
10. Added 2x3 DFN package to **Section 6.0 "Packaging Information"** and updated Package Outline Drawings.
11. Added 2x3 DFN package to **Product Identification System** section.

Revision C (March 2005)

The following is the list of modifications:

1. Added the MCP6244 quad op amp.
2. Re-compensated parts. Specifications that change are: Gain Bandwidth Product (BWP) and Phase Margin (PM) in AC Electrical Characteristics table.
3. Corrected plots in **Section 2.0 "Typical Performance Curves"**.
4. Added **Section 3.0 "Pin Descriptions"**.
5. Added new SC-70 package markings. Added PDIP-14, SOIC-14, and TSSOP-14 packages and corrected package marking information (**Section 6.0 "Packaging Information"**).
6. Added **Appendix A: "Revision History"**.

Revision B (August 2004)

Undocumented changes.

Revision A (March 2004)

- Original Release of this Document.

MCP6241/1R/1U/2/4

NOTES:

MCP6241/1R/1U/2/4

PRODUCT IDENTIFICATION SYSTEM

To order or obtain information, e.g., on pricing or delivery, refer to the factory or the listed sales office.

<u>PART NO.</u>	<u>X</u>	<u>-X</u>	<u>/XX</u>	Examples:
Device	Tape and Reel and/or Alternate Pinout	Temperature Range	Package	
Device:	MCP6241: Single Op Amp (MSOP, PDIP, SOIC) MCP6241T: Single Op Amp (Tape and Reel) (MSOP, SOIC, SOT-23)			a) MCP6241-E/SN: Extended Temp., 8LD SOIC package.
	MCP6241RT: Single Op Amp (Tape and Reel) (SOT-23)			b) MCP6241-E/MS: Extended Temp., 8LD MSOP package.
	MCP6241UT: Single Op Amp (Tape and Reel) (SC-70, SOT-23)			c) MCP6241-E/P: Extended Temp., 8LD PDIP package.
	MCP6242: Dual Op Amp			d) MCP6241-E/MC: Extended Temp., 8LD DFN package.
	MCP6242T: Dual Op Amp (Tape and Reel) (MSOP, SOIC)			e) MCP6241RT-E/OT: Tape and Reel, Extended Temp., 5LD SOT-23 package
	MCP6244: Quad Op Amp			f) MCP6241UT-E/OT: Tape and Reel, Extended Temp., 5LD SOT-23 package.
	MCP6244T: Quad Op Amp (Tape and Reel) (SOIC, TSSOP)			g) MCP6241UT-E/LT: Tape and Reel, Extended Temp., 5LD SC-70 package.
Temperature Range:	E = -40° C to +125° C			a) MCP6242-E/SN: Extended Temp., 8LD SOIC package.
Package:	LT = Plastic Package (SC-70), 5-lead (MCP6241U only)			b) MCP6242-E/MS: Extended Temp., 8LD MSOP package.
	MC = Plastic Dual Flat, No Lead (DFN), 8-lead, (MCP6241 only)			c) MCP6242-E/P: Extended Temp., 8LD PDIP package.
	MS = Plastic Micro Small Outline (MSOP), 8-lead			d) MCP6242T-E/SN: Tape and Reel, Extended Temp., 8LD SOIC package.
	P = Plastic DIP (300 mil Body), 8-lead, 14-lead			a) MCP6244-E/P: Extended Temp., 14LD PDIP package.
	OT = Plastic Small Outline Transistor (SOT-23), 5-lead (MCP6241, MCP6241R, MCP6241U)			b) MCP6244-E/SL: Extended Temp., 14LD SOIC package.
	SN = Plastic SOIC (150 mil Body), 8-lead			c) MCP6244-E/ST: Extended Temp., 14LD TSSOP package.
	SL = Plastic SOIC (150 mil Body), 14-lead			d) MCP6244T-E/SL: Tape and Reel, Extended Temp., 14LD SOIC package.
	ST = Plastic TSSOP (4.4 mil Body), 14-lead			e) MCP6244T-E/ST: Tape and Reel, Extended Temp., 14LD TSSOP package.

MCP6241/1R/1U/2/4

NOTES:

Note the following details of the code protection feature on Microchip devices:

- Microchip products meet the specification contained in their particular Microchip Data Sheet.
- Microchip believes that its family of products is one of the most secure families of its kind on the market today, when used in the intended manner and under normal conditions.
- There are dishonest and possibly illegal methods used to breach the code protection feature. All of these methods, to our knowledge, require using the Microchip products in a manner outside the operating specifications contained in Microchip's Data Sheets. Most likely, the person doing so is engaged in theft of intellectual property.
- Microchip is willing to work with the customer who is concerned about the integrity of their code.
- Neither Microchip nor any other semiconductor manufacturer can guarantee the security of their code. Code protection does not mean that we are guaranteeing the product as “unbreakable.”

Code protection is constantly evolving. We at Microchip are committed to continuously improving the code protection features of our products. Attempts to break Microchip's code protection feature may be a violation of the Digital Millennium Copyright Act. If such acts allow unauthorized access to your software or other copyrighted work, you may have a right to sue for relief under that Act.

Information contained in this publication regarding device applications and the like is provided only for your convenience and may be superseded by updates. It is your responsibility to ensure that your application meets with your specifications. MICROCHIP MAKES NO REPRESENTATIONS OR WARRANTIES OF ANY KIND WHETHER EXPRESS OR IMPLIED, WRITTEN OR ORAL, STATUTORY OR OTHERWISE, RELATED TO THE INFORMATION, INCLUDING BUT NOT LIMITED TO ITS CONDITION, QUALITY, PERFORMANCE, MERCHANTABILITY OR FITNESS FOR PURPOSE. Microchip disclaims all liability arising from this information and its use. Use of Microchip devices in life support and/or safety applications is entirely at the buyer's risk, and the buyer agrees to defend, indemnify and hold harmless Microchip from any and all damages, claims, suits, or expenses resulting from such use. No licenses are conveyed, implicitly or otherwise, under any Microchip intellectual property rights.

Trademarks

The Microchip name and logo, the Microchip logo, Accuron, dsPIC, KEELOQ, KEELOQ logo, MPLAB, PIC, PICmicro, PICSTART, rfPIC, SmartShunt and UNI/O are registered trademarks of Microchip Technology Incorporated in the U.S.A. and other countries.

FilterLab, Linear Active Thermistor, MXDEV, MXLAB, SEEVAL, SmartSensor and The Embedded Control Solutions Company are registered trademarks of Microchip Technology Incorporated in the U.S.A.

Analog-for-the-Digital Age, Application Maestro, CodeGuard, dsPICDEM, dsPICDEM.net, dsPICworks, dsSPEAK, ECAN, ECONOMONITOR, FanSense, In-Circuit Serial Programming, ICSP, ICEPIC, Mindi, MiWi, MPASM, MPLAB Certified logo, MPLIB, MPLINK, mTouch, PICkit, PICDEM, PICDEM.net, PICtail, PIC³² logo, PowerCal, PowerInfo, PowerMate, PowerTool, REAL ICE, rfLAB, Select Mode, Total Endurance, WiperLock and ZENA are trademarks of Microchip Technology Incorporated in the U.S.A. and other countries.

SQTP is a service mark of Microchip Technology Incorporated in the U.S.A.

All other trademarks mentioned herein are property of their respective companies.

© 2008, Microchip Technology Incorporated, Printed in the U.S.A., All Rights Reserved.

 Printed on recycled paper.

QUALITY MANAGEMENT SYSTEM
CERTIFIED BY DNV
== ISO/TS 16949:2002 ==

Microchip received ISO/TS-16949:2002 certification for its worldwide headquarters, design and wafer fabrication facilities in Chandler and Tempe, Arizona; Gresham, Oregon and design centers in California and India. The Company's quality system processes and procedures are for its PIC® MCUs and dsPIC® DSCs, KEELOQ® code hopping devices, Serial EEPROMs, microperipherals, nonvolatile memory and analog products. In addition, Microchip's quality system for the design and manufacture of development systems is ISO 9001:2000 certified.



WORLDWIDE SALES AND SERVICE

AMERICAS

Corporate Office
2355 West Chandler Blvd.
Chandler, AZ 85224-6199
Tel: 480-792-7200
Fax: 480-792-7277
Technical Support:
<http://support.microchip.com>
Web Address:
www.microchip.com

Atlanta
Duluth, GA
Tel: 678-957-9614
Fax: 678-957-1455

Boston
Westborough, MA
Tel: 774-760-0087
Fax: 774-760-0088

Chicago
Itasca, IL
Tel: 630-285-0071
Fax: 630-285-0075

Dallas
Addison, TX
Tel: 972-818-7423
Fax: 972-818-2924

Detroit
Farmington Hills, MI
Tel: 248-538-2250
Fax: 248-538-2260

Kokomo
Kokomo, IN
Tel: 765-864-8360
Fax: 765-864-8387

Los Angeles
Mission Viejo, CA
Tel: 949-462-9523
Fax: 949-462-9608

Santa Clara
Santa Clara, CA
Tel: 408-961-6444
Fax: 408-961-6445

Toronto
Mississauga, Ontario,
Canada
Tel: 905-673-0699
Fax: 905-673-6509

ASIA/PACIFIC

Asia Pacific Office
Suites 3707-14, 37th Floor
Tower 6, The Gateway
Harbour City, Kowloon
Hong Kong
Tel: 852-2401-1200
Fax: 852-2401-3431

Australia - Sydney
Tel: 61-2-9868-6733
Fax: 61-2-9868-6755

China - Beijing
Tel: 86-10-8528-2100
Fax: 86-10-8528-2104

China - Chengdu
Tel: 86-28-8665-5511
Fax: 86-28-8665-7889

China - Hong Kong SAR
Tel: 852-2401-1200
Fax: 852-2401-3431

China - Nanjing
Tel: 86-25-8473-2460
Fax: 86-25-8473-2470

China - Qingdao
Tel: 86-532-8502-7355
Fax: 86-532-8502-7205

China - Shanghai
Tel: 86-21-5407-5533
Fax: 86-21-5407-5066

China - Shenyang
Tel: 86-24-2334-2829
Fax: 86-24-2334-2393

China - Shenzhen
Tel: 86-755-8203-2660
Fax: 86-755-8203-1760

China - Wuhan
Tel: 86-27-5980-5300
Fax: 86-27-5980-5118

China - Xiamen
Tel: 86-592-2388138
Fax: 86-592-2388130

China - Xian
Tel: 86-29-8833-7252
Fax: 86-29-8833-7256

China - Zhuhai
Tel: 86-756-3210040
Fax: 86-756-3210049

ASIA/PACIFIC

India - Bangalore
Tel: 91-80-4182-8400
Fax: 91-80-4182-8422

India - New Delhi
Tel: 91-11-4160-8631
Fax: 91-11-4160-8632

India - Pune
Tel: 91-20-2566-1512
Fax: 91-20-2566-1513

Japan - Yokohama
Tel: 81-45-471- 6166
Fax: 81-45-471-6122

Korea - Daegu
Tel: 82-53-744-4301
Fax: 82-53-744-4302

Korea - Seoul
Tel: 82-2-554-7200
Fax: 82-2-558-5932 or
82-2-558-5934

Malaysia - Kuala Lumpur
Tel: 60-3-6201-9857
Fax: 60-3-6201-9859

Malaysia - Penang
Tel: 60-4-227-8870
Fax: 60-4-227-4068

Philippines - Manila
Tel: 63-2-634-9065
Fax: 63-2-634-9069

Singapore
Tel: 65-6334-8870
Fax: 65-6334-8850

Taiwan - Hsin Chu
Tel: 886-3-572-9526
Fax: 886-3-572-6459

Taiwan - Kaohsiung
Tel: 886-7-536-4818
Fax: 886-7-536-4803

Taiwan - Taipei
Tel: 886-2-2500-6610
Fax: 886-2-2508-0102

Thailand - Bangkok
Tel: 66-2-694-1351
Fax: 66-2-694-1350

EUROPE

Austria - Wels
Tel: 43-7242-2244-39
Fax: 43-7242-2244-393

Denmark - Copenhagen
Tel: 45-4450-2828
Fax: 45-4485-2829

France - Paris
Tel: 33-1-69-53-63-20
Fax: 33-1-69-30-90-79

Germany - Munich
Tel: 49-89-627-144-0
Fax: 49-89-627-144-44

Italy - Milan
Tel: 39-0331-742611
Fax: 39-0331-466781

Netherlands - Drunen
Tel: 31-416-690399
Fax: 31-416-690340

Spain - Madrid
Tel: 34-91-708-08-90
Fax: 34-91-708-08-91

UK - Wokingham
Tel: 44-118-921-5869
Fax: 44-118-921-5820



Стандарт Электрон Связь

Мы молодая и активно развивающаяся компания в области поставок электронных компонентов. Мы поставляем электронные компоненты отечественного и импортного производства напрямую от производителей и с крупнейших складов мира.

Благодаря сотрудничеству с мировыми поставщиками мы осуществляем комплексные и плановые поставки широчайшего спектра электронных компонентов.

Собственная эффективная логистика и склад в обеспечивает надежную поставку продукции в точно указанные сроки по всей России.

Мы осуществляем техническую поддержку нашим клиентам и предпродажную проверку качества продукции. На все поставляемые продукты мы предоставляем гарантию .

Осуществляем поставки продукции под контролем ВП МО РФ на предприятия военно-промышленного комплекса России , а также работаем в рамках 275 ФЗ с открытием отдельных счетов в уполномоченном банке. Система менеджмента качества компании соответствует требованиям ГОСТ ISO 9001.

Минимальные сроки поставки, гибкие цены, неограниченный ассортимент и индивидуальный подход к клиентам являются основой для выстраивания долгосрочного и эффективного сотрудничества с предприятиями радиоэлектронной промышленности, предприятиями ВПК и научно-исследовательскими институтами России.

С нами вы становитесь еще успешнее!

Наши контакты:

Телефон: +7 812 627 14 35

Электронная почта: sales@st-electron.ru

Адрес: 198099, Санкт-Петербург,
Промышленная ул, дом № 19, литера Н,
помещение 100-Н Офис 331