



# MIC3201

## High Brightness LED Driver with High-Side Current Sense

### General Description

The MIC3201 is a hysteretic step-down, constant-current, High-Brightness LED (HB LED) driver capable of driving up to four, 1A LEDs. It provides an ideal solution for interior/exterior lighting, architectural and ambient lighting, LED bulbs, and other general illumination applications.

The MIC3201 operates with an input voltage range from 6V to 20V. The hysteretic control gives good supply rejection and fast response during load transients and PWM dimming. The high-side current sensing and on-chip current sense amplifier delivers LED current with  $\pm 5\%$  accuracy. An external high-side current sense resistor is used to set the output current.

The MIC3201 offers a dedicated PWM input (DIM) which enables a wide range of pulsed dimming. A high switching frequency operation up to 1MHz allows the use of smaller external components minimizing space and cost.

The MIC3201 operates over a junction temperature range of  $-40^{\circ}\text{C}$  to  $+125^{\circ}\text{C}$  and is available in an 8-pin ePAD SOIC package.

Datasheets and support documentation can be found on Micrel's web site at: [www.micrel.com](http://www.micrel.com).

### Features

- 6.0V to 20V input voltage range
- High efficiency (>90%)
- $\pm 5\%$  LED current accuracy
- High-side current sense
- Dedicated dimming control input
- Hysteretic control (no compensation!)
- 1A internal power switch
- Up to 1MHz switching frequency
- Adjustable constant LED current
- 5V on board regulator
- Over temperature protection
- $-40^{\circ}\text{C}$  to  $+125^{\circ}\text{C}$  junction temperature range
- Available in an 8-Pin ePAD SOIC package

### Applications

- Architectural, industrial, and ambient lighting
- LED bulbs
- Indicators and emergency lighting
- Street lighting
- Channel letters
- 12V lighting systems (MR-16 bulbs, under cabinet lighting, garden/pathway lighting)

### Typical Application

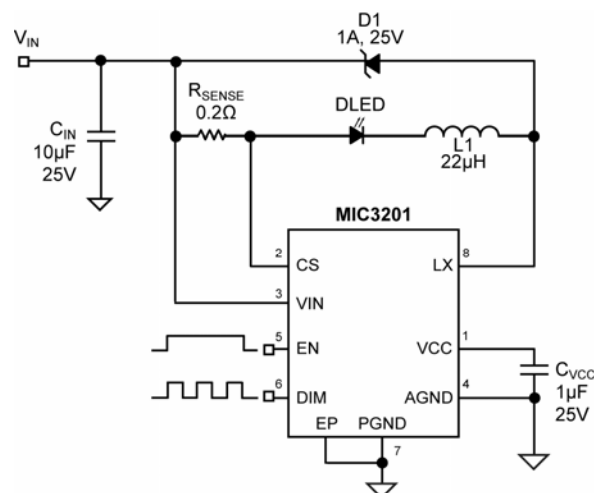

MIC3201 Step-down LED Driver Circuit

## Ordering Information<sup>(1)</sup>

Part Number	Marking	Junction Temp. Range	Package	Lead Finish
MIC3201YME	MIC3201YME	-40°C to +125°C	8-Pin ePAD SOIC	Pb-Free

**Note:**

1. YME<sup>®</sup> is a GREEN RoHS compliant package. Lead finish is NiPdAu. Mold compound is Halogen Free.

## Pin Configuration

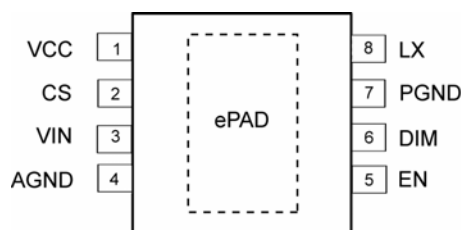

8-Pin ePAD SOIC (ME)

## Pin Description

Pin Number	Pin Name	Pin Function
1	VCC	Voltage Regulator Output. The V <sub>CC</sub> pin supplies the power to the internal circuitry. The V <sub>CC</sub> is the output of a linear regulator which is powered from VIN. A 1μF ceramic capacitor is recommended for bypassing and should be placed as close as possible to the V <sub>CC</sub> and AGND pins. Do not connect to an external load.
2	CS	Current Sense Input. The CS pin provides the high-side current sense to set the LED current with an external sense resistor.
3	VIN	Input Power Supply. VIN is the input supply pin to the internal circuitry and the positive input to the current sense comparator. Due to the high frequency switching noise, a 10μF ceramic capacitor is recommended to be placed as close as possible to VIN and the power ground (PGND) pin for bypassing. Please refer to layout recommendations.
4	AGND	Ground pin for analog circuitry. Internal signal ground for all low power sections.
5	EN	Enable Input. The EN pin provides a logic level control of the output and the voltage has to be 2.0V or higher to enable the current regulator. The output stage is gated by the DIM pin. When the EN pin is pulled low, the regulator goes to off state and the supply current of the device is greatly reduced (below 1μA). In the off state, the output drive is placed in a "tri-stated" condition, where MOSFET is in an "off" or non-conducting state. Do not drive the EN pin above the supply voltage.
6	DIM	PWM Dimming Input. The DIM pin provides the control for brightness of the LED. A PWM input can be used to control the brightness of LED. DIM high enables the output and its voltage has to be at least 2.0V or higher. DIM low disables the output, regardless of EN "high" state.
7	PGND	Power Ground pin for Power FET. Power Ground (PGND) is the ground path for the high current hysteretic mode. The current loop for the power ground should be as small as possible and separate from the Analog ground (AGND) loop. Refer to the layout considerations for more details.
8	LX	Drain of Internal Power MOSFET. The LX pin connects directly to the inductor and provides the switching current necessary to operate in hysteretic mode. Due to the high frequency switching and high voltage associated with this pin, the switch node should be routed away from sensitive nodes.
EP	GND	Connect to PGND.

**Absolute Maximum Ratings<sup>(1)</sup>**

$V_{IN}$ , $V_{CS}$ to PGND/AGND .....	-0.3V to +22V
$V_{DIM}$ , $V_{EN}$ to PGND/AGND .....	-0.3V to $V_{IN}$
$V_{LX}$ to PGND/AGND .....	-0.3V to $V_{IN}+1.0V$
$V_{CC}$ to PGND/AGND .....	-0.3V to +7.0V
$V_{CS}$ to $V_{IN}$ .....	0.3V
$V_{PGND}$ to $V_{AGND}$ .....	-0.3V to +0.3V
Storage Temperature ( $T_s$ ).....	-60°C to +150°C
Lead Temperature (Soldering, 10sec) .....	260°C
ESD Ratings (HBM) <sup>(3)</sup> .....	2kV
(MM) <sup>(3)</sup> .....	100V

**Operating Ratings<sup>(2)</sup>**

Supply Voltage ( $V_{IN}$ ).....	6.0V to 20V
Junction Temperature ( $T_J$ ) .....	-40°C to +125°C
Junction Thermal Resistance	
SOIC ( $\theta_{JA}$ ).....	41°C/W
SOIC ( $\theta_{JC}$ ).....	14.7°C/W

**Electrical Characteristics<sup>(4)</sup>**

$V_{IN} = 12V$ ,  $V_{DIM} = V_{EN} = V_{IN}$ ,  $C_{VCC} = 1\mu F$ , **bold** values indicate  $-40^\circ C \leq T_J \leq +125^\circ C$ , unless noted.

Typical values are at  $T_A = +25^\circ C$ .

Symbol	Parameter	Condition	Min	Typ	Max	Units
$V_{IN}$	Operating Input Voltage Range		6.0		20.0	V
$I_S$	Supply Current	LX open		1.2	<b>1.75</b>	mA
$I_{SD}$	Shut Down Supply Current	$V_{EN} = 0V$ $T_A = 25^\circ C$			1	$\mu A$
$V_{CS(MAX)}$	Sense Voltage Threshold High	$V_{IN} - V_{CS}$	206		224	mV
$V_{CS(MIN)}$	Sense Voltage Threshold Low	$V_{IN} - V_{CS}$	171		189	mV
$V_{HYS}$	Current Sense Hysteresis			35		mV
	Current Sense Response Time	$V_{CS}$ Rising		100		ns
		$V_{CS}$ Falling		60		ns
	CS Pin Input Current	$V_{IN} - V_{CS} = 200mV$			<b>3</b>	$\mu A$
$R_{DSON}$	Internal Switch $R_{ON}$			300	<b>550</b>	m $\Omega$
$F_{MAX}$	Maximum Switching Frequency				1.0	MHz
VCC	VCC Regulator			6		V
$EN_{HI}$	EN Input Voltage High		2.0			V
$EN_{LO}$	EN Input Voltage Low				0.4	V
	EN Input Current High	$V_{EN} = 12V$		30	<b>50</b>	$\mu A$
	EN Input Leakage Low	$V_{EN} = 0V$			<b>1</b>	$\mu A$
$DIM_{HI}$	DIM Input Voltage High		2.0			V
$DIM_{LO}$	DIM Input Voltage Low				0.4	V
	DIM Input Current High	$V_{DIM} = 12V$		22	<b>30</b>	$\mu A$
	DIM Input Leakage Low	$V_{DIM} = 0V$			<b>1</b>	$\mu A$
$F_{DIM}$	Maximum DIM Frequency				20	kHz
	LX Pin Leakage Current	$V_{IN} - V_{CS} \geq 250mV$ $V_{LX} = V_{IN}$		5		$\mu A$
$T_{LIM}$	Over-Temperature Shutdown			165		$^\circ C$
$T_{LIMHYS}$	Over-Temperature Shutdown Hysteresis			20		$^\circ C$
	Start-up Time	From EN Pin going high, DIM = 12V, $C_{VCC} = 1\mu F$		300		$\mu s$

**Notes:**

- Exceeding the absolute maximum rating may damage the device.
- The device is not guaranteed to function outside its operating rating.
- Devices are ESD sensitive. Handling precautions recommended. Human body model, 1.5k in series with 100pF.
- Specification for packaged product only.

# Typical Characteristics

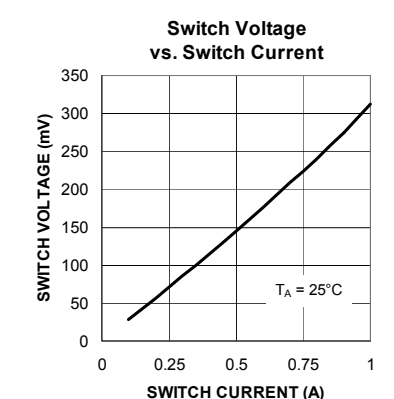
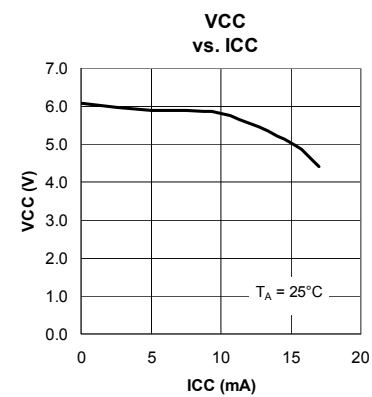
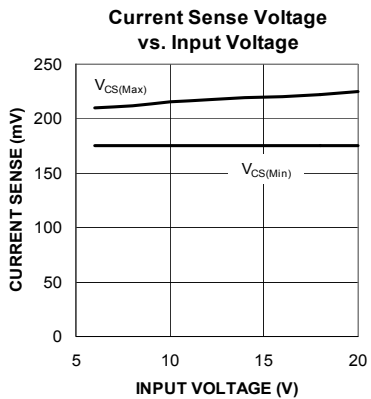
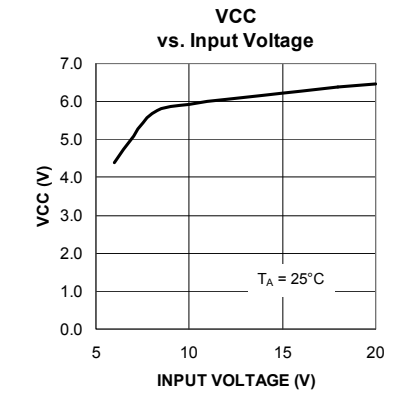
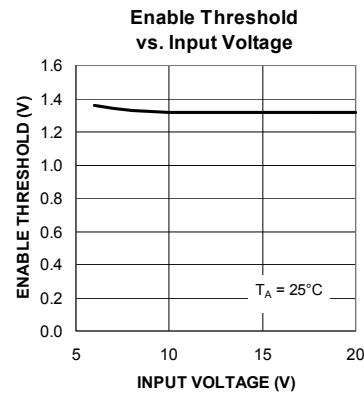
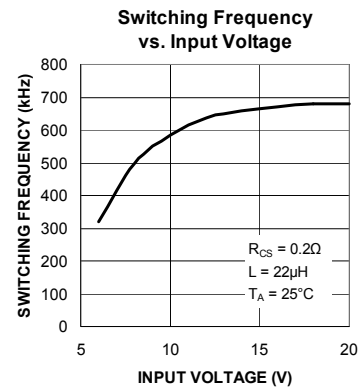
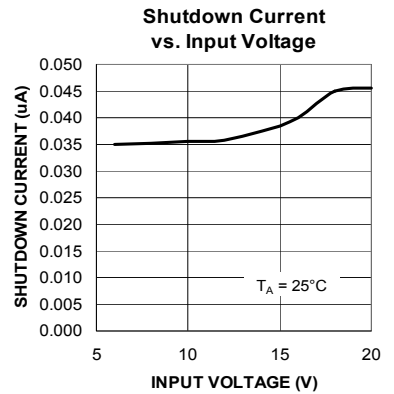
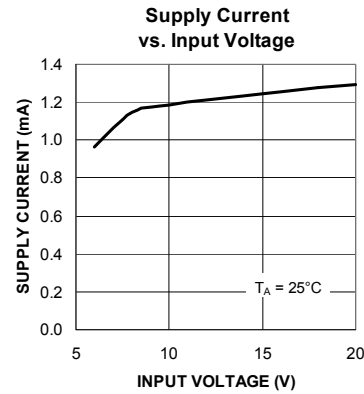
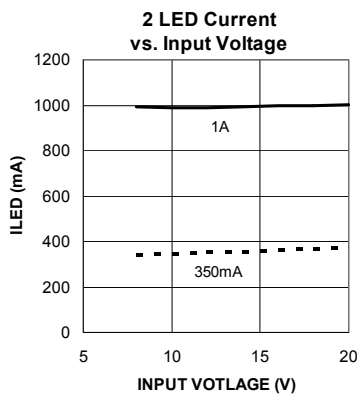
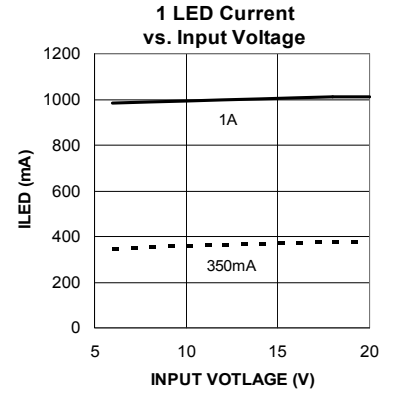
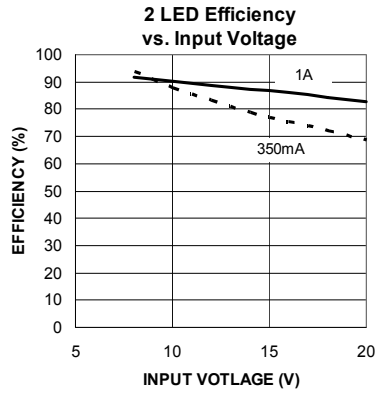
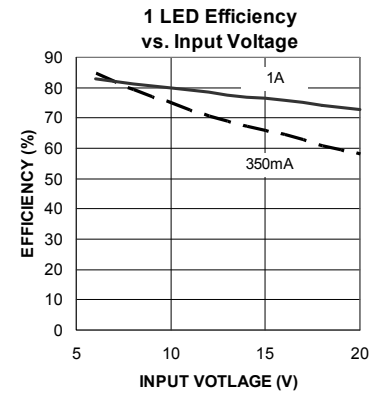

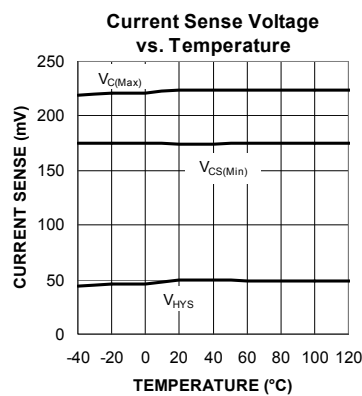
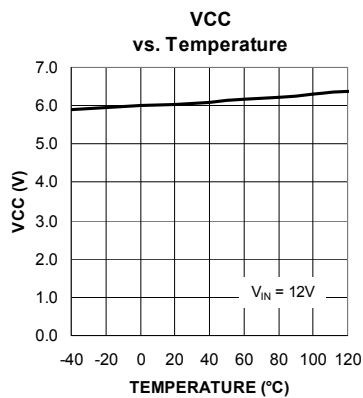
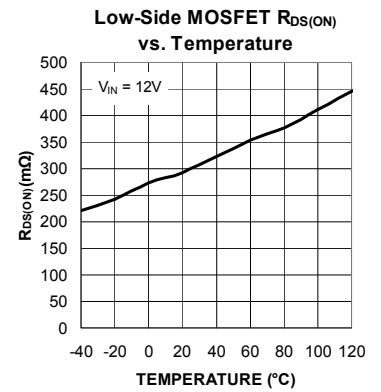
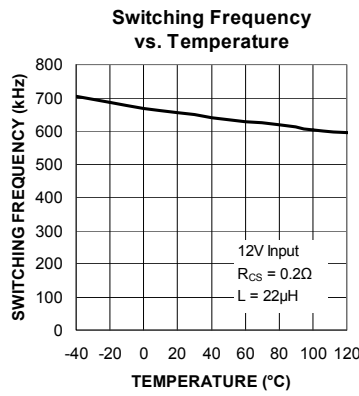
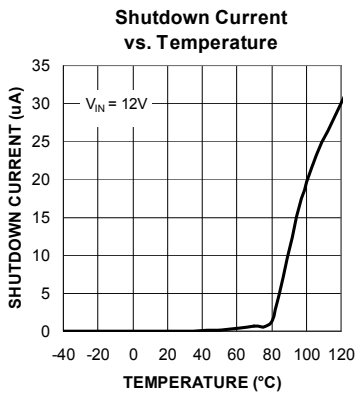
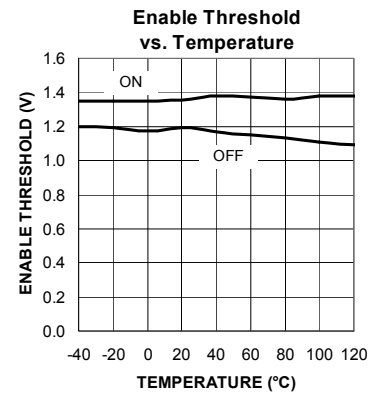
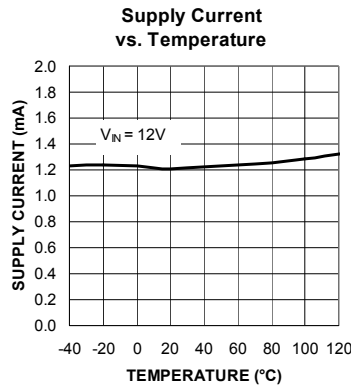
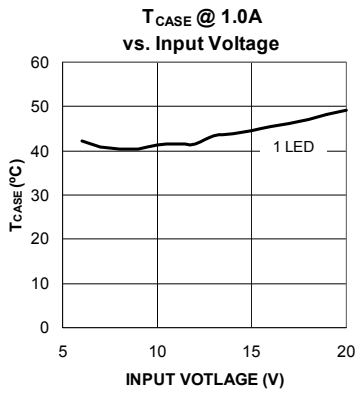
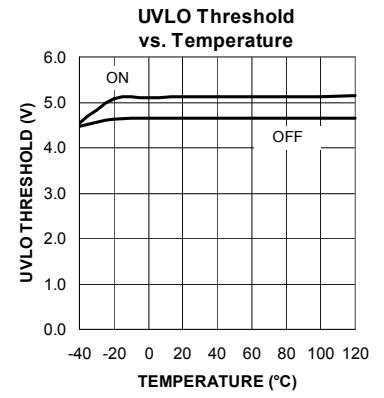
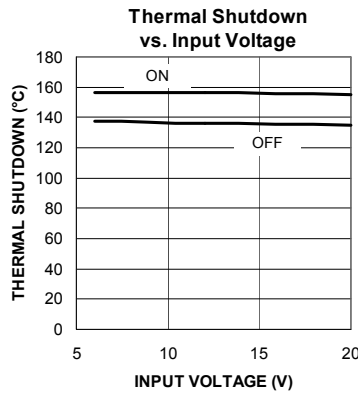
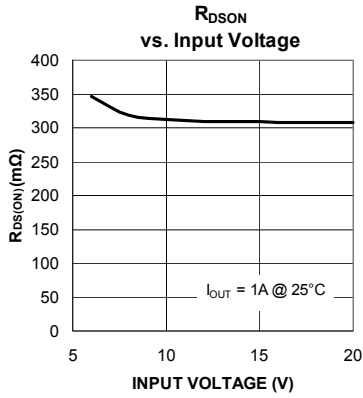

## Functional Characteristics

$I_{LED}$  and  $V_{LX}$  @  $V_{IN} = 6V$

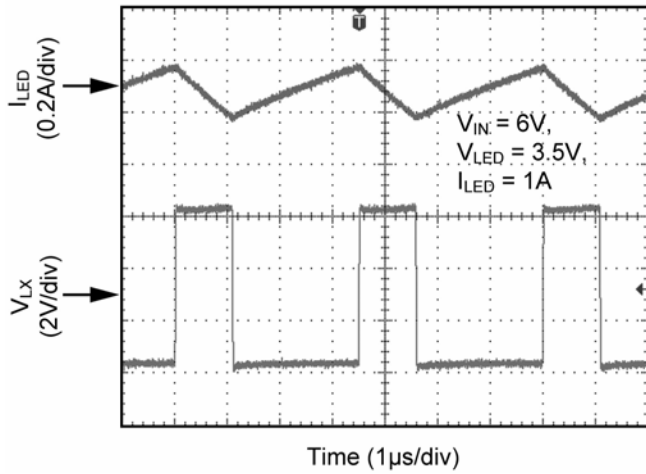

$I_{LED}$  and  $V_{LX}$  @  $V_{IN} = 12V$

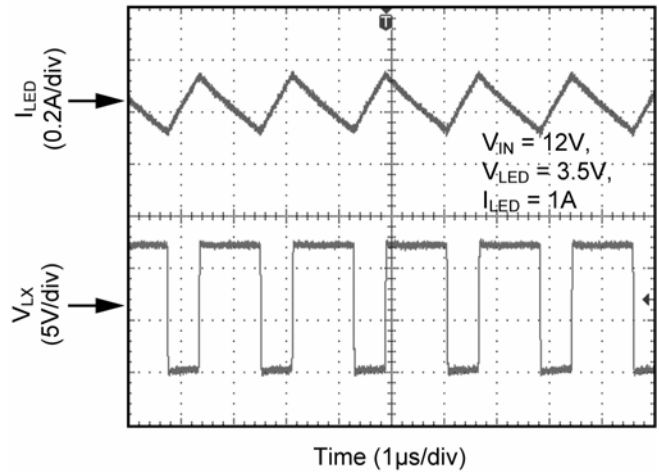

$I_{LED}$  and  $V_{LX}$  @  $V_{IN} = 20V$

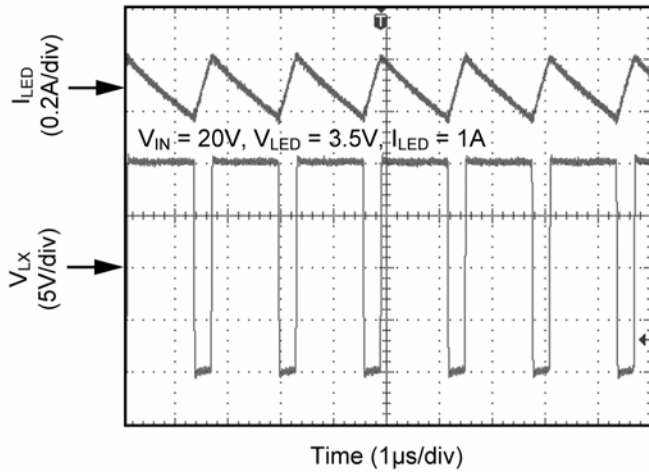

20kHz Dimming @ 10% Duty

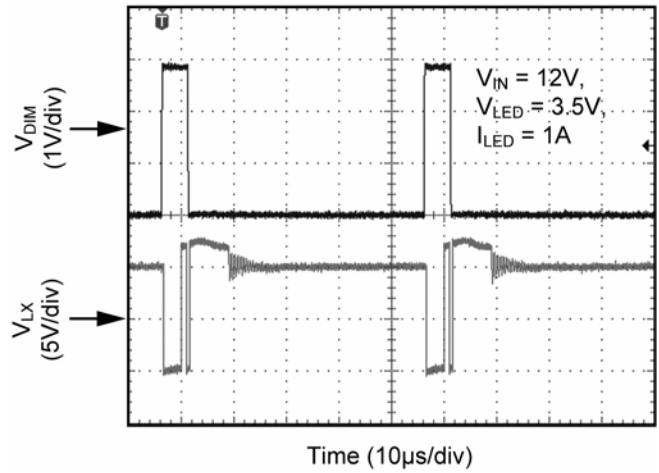

20kHz Dimming @ 90% Duty

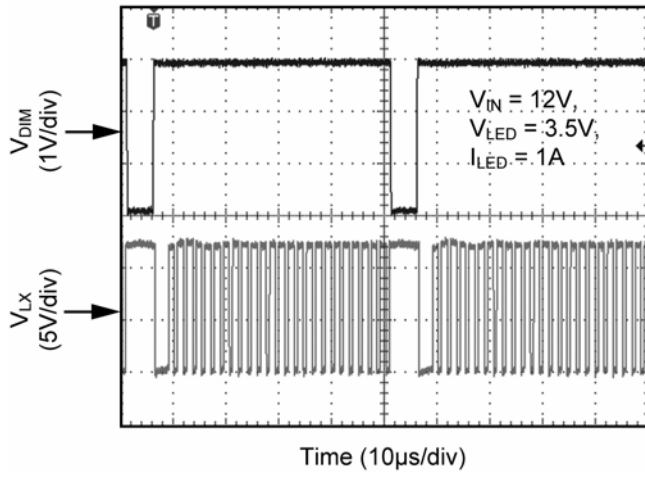

100Hz Dimming @ 1% Duty

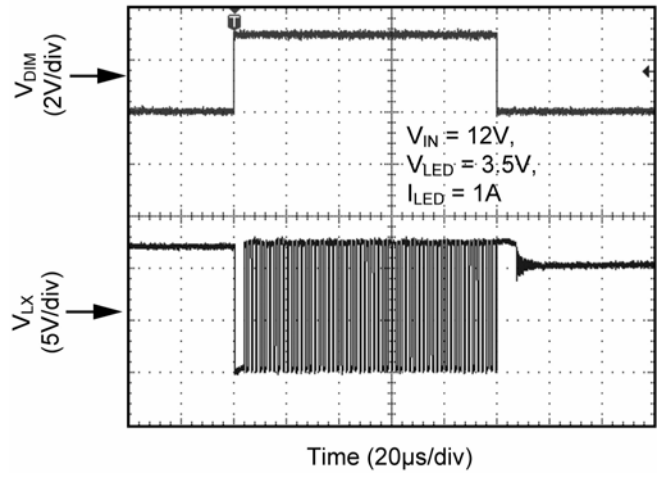

100Hz Dimming @ 99% Duty

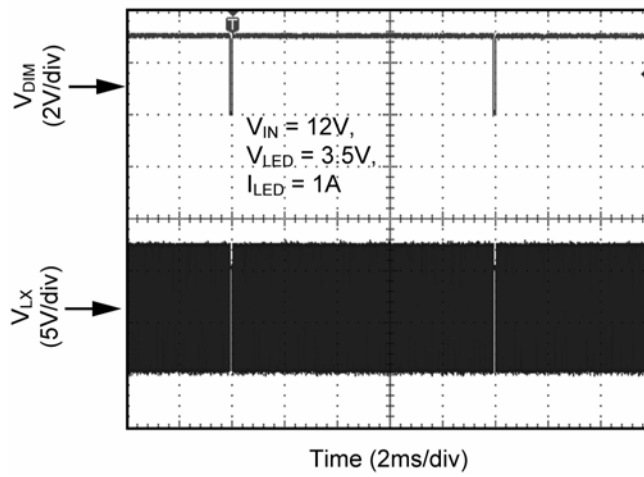

## Functional Diagram

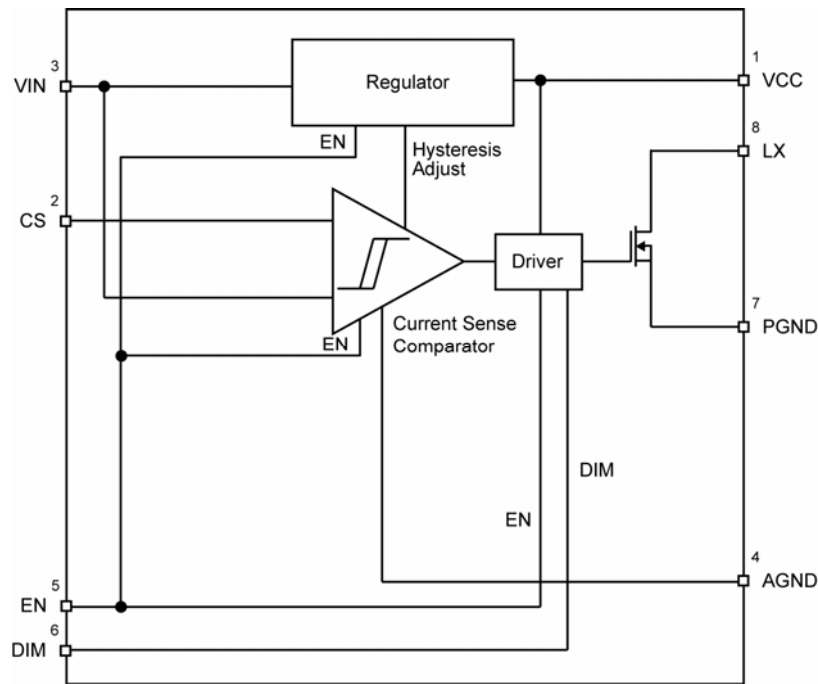

Figure 1. MIC3201 Block Diagram

## Functional Description

The MIC3201 is a hysteretic step-down regulator which regulates the LED current over wide input voltage range and capable of driving up to four, 1A LEDs in series.

The device operates from a 6V to 20V input voltage range, and includes an integrated 1.0A power switch. When the input voltage approaches 6V, the internal 5V VCC is regulated and the integrated MOSFET is turned on if EN pin and DIM pin are high. The inductor current builds up linearly. When the CS pin voltage hits the  $V_{CS(MAX)}$  with respect to  $V_{IN}$ , the internal MOSFET turns off and the Schottky diode takes over and returns the current to  $V_{IN}$ . Then the current through inductor and LEDs starts decreasing. When CS pin hits  $V_{CS(MIN)}$ , the internal MOSFET turns on and the cycle repeats.

The frequency of operation depends upon input voltage, total LEDs voltage drop, LED current and temperature. The calculation for frequency of operation is given in application section.

The MIC3201 has an on board **5V regulator which is for internal use only**. Connect a 1 $\mu$ F capacitor on VCC pin to analog ground.

The MIC3201 has an EN pin which gives the flexibility to enable and disable the output with logic high and low signals.

The MIC3201 also has a DIM pin which can turn on and off the LEDs if EN is in HIGH state. This DIM pin controls the brightness of the LED by varying the duty cycle from 1% to 99%.



## Application Information

The MIC3201 is a hysteretic step-down constant-current High-Brightness LED (HB LED) driver. The internal block diagram is shown in Figure 1. The MIC3201 is composed of a current sense comparator, voltage and current reference, 5V regulator, MOSFET driver, and a MOSFET. Hysteretic mode control, also called bang-bang control, is the topology that does not employ an error amplifier, and instead uses an error comparator.

The inductor current is controlled within a hysteretic window. If the inductor current is too small, the power MOSFET is turned on; if the inductor current is large enough, the power MOSFET is turned off. It is a simple control scheme with no oscillator and no loop compensation. Since the control scheme does not need loop compensation, it makes a design easy, and avoids problems of instability.

Transient response to load and line variation is very fast and only depends on propagation delay. This makes the control scheme very popular for certain applications.

### LED Current and $R_{CS}$

The main feature in MIC3201 is to control the LED current accurately within  $\pm 5\%$  of set current. Choosing a high-side  $R_{CS}$  resistor helps for setting constant LED current irrespective of wide input voltage range. The following equation gives the  $R_{CS}$  value:

$$R_{CS} = \frac{1}{2} \left( \frac{V_{CS(MAX)} + V_{CS(MIN)}}{I_{LED}} \right)$$

$R_{CS}$ ( $\Omega$ )	$I_{LED}$ (A)	$I^2R$ (W)	Size (SMD)
2.00	0.1	0.0200	0402
1.00	0.2	0.0400	0402
0.63	0.3	0.0567	0402
0.56	0.35	0.0691	0603
0.50	0.4	0.0800	0603
0.40	0.5	0.1000	0805
0.33	0.6	0.1188	0805
0.28	0.7	0.1372	0805
0.24	0.8	0.1536	0805
0.22	0.9	0.1782	0805
0.20	1.0	0.2000	1206

Table 1. Selecting  $R_{CS}$  for LED Current

For  $V_{CS(MAX)}$  and  $V_{CS(MIN)}$  refer to the electrical characteristic table.

### Frequency of Operation

To calculate the frequency spread across input supply:

$$V_L = L \frac{dl}{dt}$$

L is the inductance, dl is fixed (the value of the hysteresis)

$$dl = \frac{V_{CS(MAX)} - V_{CS(MIN)}}{R_{CS}}$$

$V_L$  voltage across inductor L which varies by supply.

For current rising (MOSFET is ON):

$$t_r = L \frac{dl}{V_{L\_RISE}}$$

where:

$$V_{L\_RISE} = V_{IN} - I_{LED} \cdot R_{CS} - V_{LED}$$

For current falling (MOSFET is OFF):

$$t_f = L \frac{dl}{V_{L\_FALL}}$$

where:

$$V_{L\_FALL} = V_D + I_{LED} \cdot R_{CS} + V_{LED}$$

$$T = t_r + t_f, F_{SW} = \frac{1}{T}$$

$$F_{SW} = \frac{(V_D + I_{LED} \cdot R_{CS} + V_{LED}) \cdot (V_{IN} - I_{LED} \cdot R_{CS} - V_{LED})}{L \cdot dl \cdot (V_D + V_{IN})}$$

Where

$V_D$  is Schottky diode forward drop

$V_{LED}$  is total LEDs voltage drop

$V_{IN}$  is input voltage

$I_{LED}$  is average LED current:

According to the above equation, choose the inductor to make the operating frequency no higher than 1MHz.

### Free Wheeling Diode

The free wheeling diode should have the reverse voltage rating to accommodate the maximum input voltage. The forward voltage drop should be small to get the lowest conduction dissipation for high efficiency. The forward current rating has to be at least equal to LED current. A Schottky diode is recommended.

### LED Ripple Current

The LED current is the same as inductor current. If LED ripple current needs to be reduced then place a 10 $\mu$ F capacitor across LED.

## PCB Layout Guideline

**Warning!!! To minimize EMI and output noise, follow these layout recommendations.**

PCB Layout is critical to achieve reliable, stable and efficient performance. A ground plane is required to control EMI and minimize the inductance in power, signal and return paths.

The following guidelines should be followed to insure proper operation of the MIC3201 regulator.

### IC

Use fat traces to route the input and output power lines.

The exposed pad (EP) on the bottom of the IC must be connected to the ground.

Use four via to connect the EP to the ground plane.

Signal and power grounds should be kept separate and connected at only one location.

### Input Capacitor

Place the input capacitors on the same side of the board and as close to the IC as possible.

Keep both the VIN and PGND connections short.

Place several vias to the ground plane close to the input capacitor ground terminal, but not between the input capacitors and IC pins.

Use either X7R or X5R dielectric input capacitors. Do not use Y5V or Z5U type capacitors.

Do not replace the ceramic input capacitor with any other type of capacitor. Any type of capacitor can be placed in parallel with the input capacitor.

If a Tantalum input capacitor is placed in parallel with the input capacitor, it must be recommended for switching regulator applications and the operating voltage must be derated by 50%.

In "Hot-Plug" applications, a Tantalum or Electrolytic bypass capacitor must be placed in parallel to ceramic capacitor to limit the over-voltage spike seen on the input supply with power is suddenly applied. In this case, an additional Tantalum or Electrolytic bypass input capacitor of 22 $\mu$ F or higher is required at the input power connection if necessary.

### Inductor

Keep the inductor connection to the switch node (LX) short.

Do not route any digital lines underneath or close to the inductor.

To minimize noise, place a ground plane underneath the inductor.

### Output Capacitor

If LED ripple current needs to be reduced then place a 10 $\mu$ F capacitor across LED. The capacitor must be placed as close to the LED as possible.

### Diode

Place the Schottky diode on the same side of the board as the IC and input capacitor.

The connection from the Schottky diode's Anode to the IC LX pin must be as short as possible.

The diode's Cathode connection to the R<sub>CS</sub> must be keep as short as possible.

### RC Snubber

If a RC snubber is needed, place the RC snubber on the same side of the board and as close to the Schottky diode as possible.

### R<sub>CS</sub> (Current Sense Resistor)

VIN pin and CS pin must be as close as possible to R<sub>CS</sub>. Make a Kelvin connection to the VIN and CS pin respectively for current sensing.

### Trace Routing Recommendation

Keep the power traces as short and wide as possible. One current flowing loop is during the MOSFET ON time, the traces connecting the input capacitor C<sub>IN</sub>, R<sub>CS</sub>, LEDs, Inductor, the MIC3201 LX and PGND pin and back to C<sub>IN</sub>. The other current flowing loop is during the MOSFET OFF time, the traces connecting R<sub>CS</sub>, LED, inductor, free wheeling diode and back to R<sub>CS</sub>. These two loop areas should kept as small as possible to minimize the noise interference,

Keep all analog signal traces away from the LX pin and its connecting traces.

## Ripple Measurements

To properly measure ripple on either input or output of a switching regulator, a proper ring in tip measurement is required. Standard oscilloscope probes come with a grounding clip, or a long wire with an alligator clip. Unfortunately, for high frequency measurements, this ground clip can pick-up high frequency noise and erroneously inject it into the measured output ripple.

The standard evaluation board accommodates a home made version by providing probe points for both the input and output supplies and their respective grounds. This requires the removing of the oscilloscope probe sheath and ground clip from a standard oscilloscope probe and wrapping a non-shielded bus wire around the oscilloscope probe. If there does not happen to be any non-shielded bus wire immediately available, the leads from axial resistors will work. By maintaining the shortest possible ground lengths on the oscilloscope probe, true ripple measurements can be obtained.

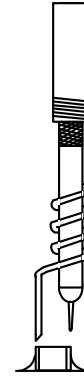

**Figure 2. Low Noise Measurement**

### Evaluation Board Schematic

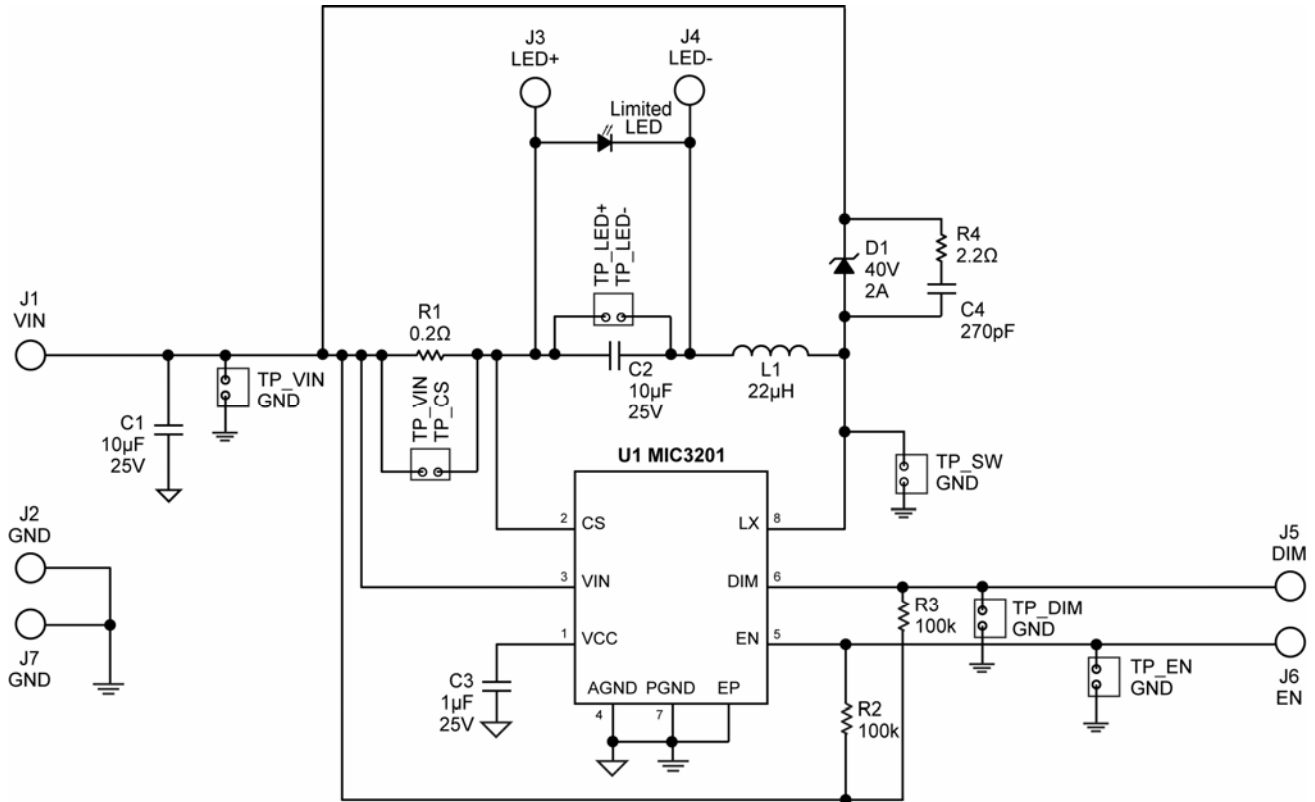

**Bill of Materials**

Item	Part Number	Manufacturer	Description	Qty.
C1, C2	12103D106KAT2A	AVX <sup>(1)</sup>	10µF/25V, Ceramic Capacitor, X5R, Size 0805	2
	GRM32DR71E106KA12L	Murata <sup>(2)</sup>	10µF/25V, Ceramic Capacitor, X7R, Size 0805	
	C3225X7R1E106M	TDK <sup>(3)</sup>	10µF/25V, Ceramic Capacitor, X7R, Size 0805	
C3	08053D105KAT2A	AVX <sup>(1)</sup>	1µF/25V, Ceramic Capacitor, X5R, Size 0805	1
	GRM216R61E105KA12D	Murata <sup>(2)</sup>	1µF/25V, Ceramic Capacitor, X5R, Size 0805	
	C2012X7R1E105K	TDK <sup>(3)</sup>	1µF/25V, Ceramic Capacitor, X7R, Size 0805	
C4	08055A271JAT2A	AVX <sup>(1)</sup>	270pF/50V, Ceramic Capacitor NPO, Size 0805	1
	GQM2195C1H271JB01D	Murata <sup>(2)</sup>		
D1	SS24-TP	MCC <sup>(4)</sup>	40V, 2A, SMA, Schottky Diode	1
	SS24	Fairchild <sup>(5)</sup>		
L1	CDRH8D43NP-220NC	SUMIDA <sup>(6)</sup>	22µH, 2.6A, SMT, Power Inductor	1
R1	CSR 1/2 0.2 1% I	Stackpole Electronics Inc <sup>(7)</sup>	0.2Ω Resistor, 1/2W, 1%, Size 1206	1
R2, R3	CRCW08051003FKEA	Vishay <sup>(8)</sup>	100kΩ Resistor, 1% , Size 0805	2
R4	CRCW08052R20FKEA	Vishay <sup>(8)</sup>	2.2 Ohms Resistor, 1%, Size 0805	1
<b>U1</b>	<b>MIC3201YME</b>	<b>Micrel, Inc.</b> <sup>(9)</sup>	High-Brightness LED Driver with High-Side Current Sense	1

**Notes:**

1. AVX: [www.avx.com](http://www.avx.com)
2. Murata: [www.murata.com](http://www.murata.com)
3. TDK: [www.tdk.com](http://www.tdk.com)
4. MCC: [www.mccsemi.com](http://www.mccsemi.com)
5. Fairchild: [www.fairchildsemi.com](http://www.fairchildsemi.com)
6. Sumida Tel: [www.sumida.com](http://www.sumida.com)
7. Stackpole Electronics: [www.seielect.com](http://www.seielect.com)
8. Vishay: [www.vishay.com](http://www.vishay.com)
9. Micrel, Inc.: [www.micrel.com](http://www.micrel.com)

# PCB Layout Recommendations

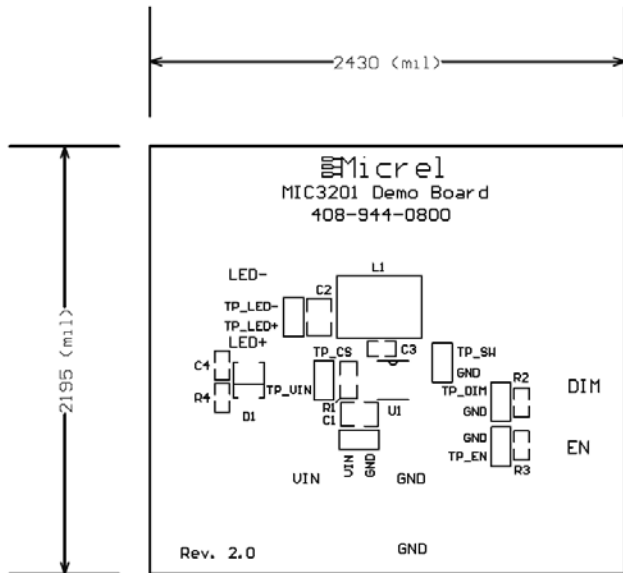

Top Assembly

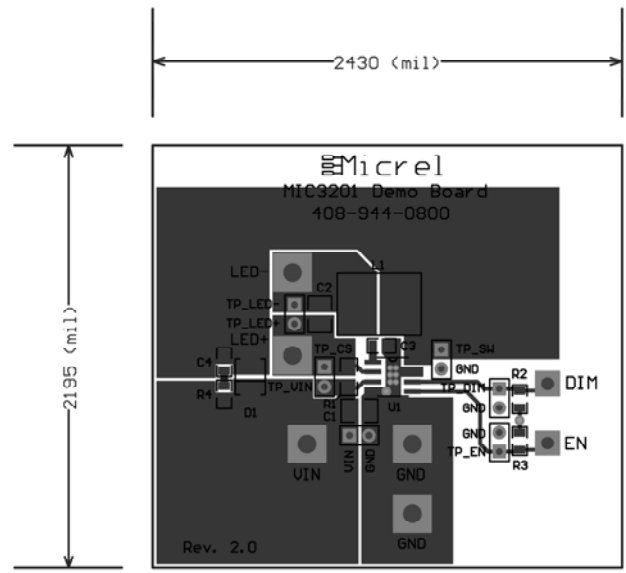

Top Layer

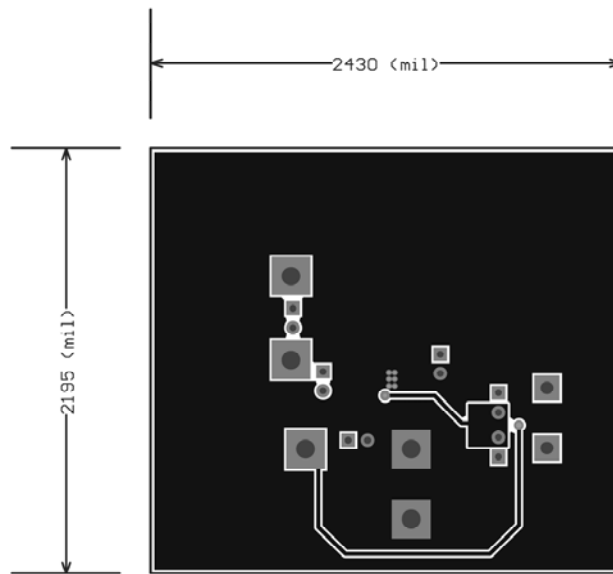

Bottom Layer

Package Information

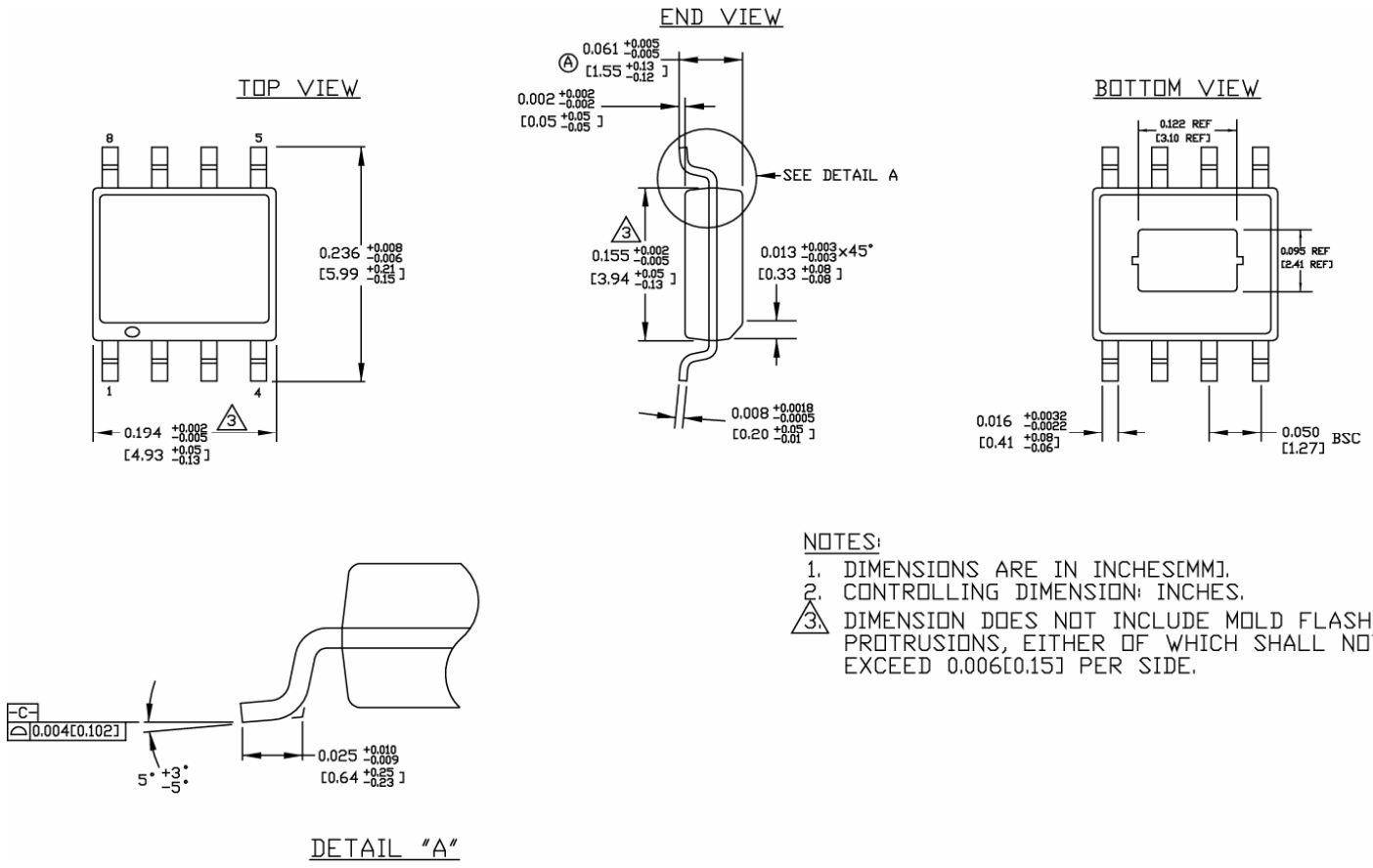

8-Pin ePAD SOIC (ME)

## Recommended Landing Pattern

LP # **SOICNEP-8LD-LP-1**

All units are in inches

Tolerance  $\pm 0.05$  if not noted

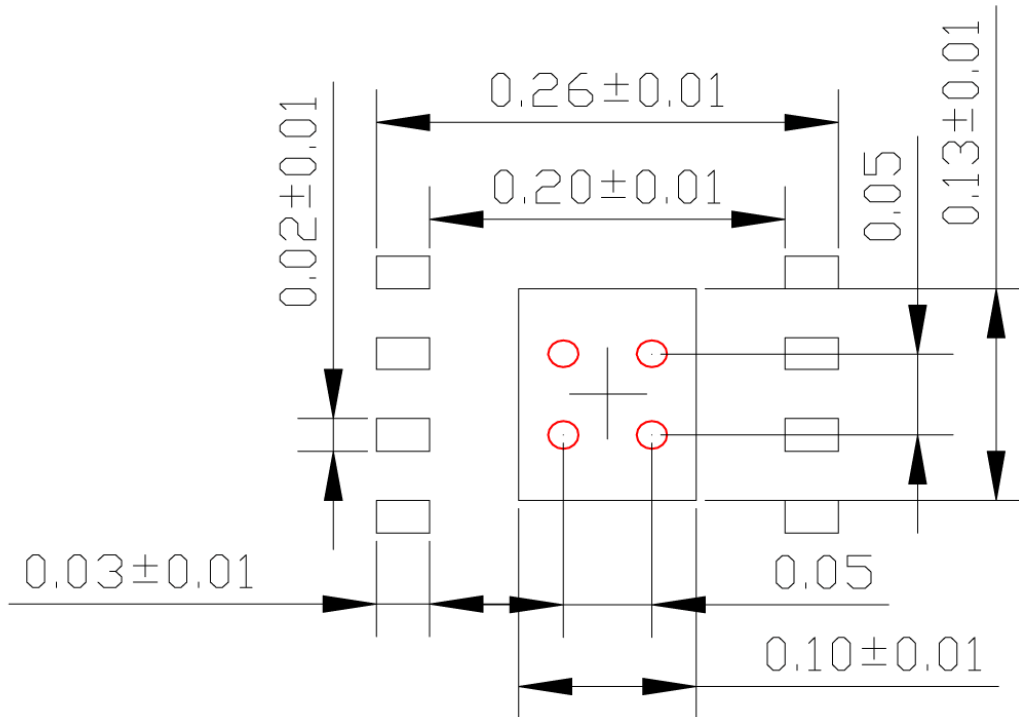

Red circle indicates Thermal Via. Size should be .015-.017 inches in diameter and it should be connected to GND plane for maximum thermal performance.

### 8-Pin ePAD SOIC

**MICREL, INC. 2180 FORTUNE DRIVE SAN JOSE, CA 95131 USA**

TEL +1 (408) 944-0800 FAX +1 (408) 474-1000 WEB <http://www.micrel.com>

Micrel makes no representations or warranties with respect to the accuracy or completeness of the information furnished in this data sheet. This information is not intended as a warranty and Micrel does not assume responsibility for its use. Micrel reserves the right to change circuitry, specifications and descriptions at any time without notice. No license, whether express, implied, arising by estoppel or otherwise, to any intellectual property rights is granted by this document. Except as provided in Micrel's terms and conditions of sale for such products, Micrel assumes no liability whatsoever, and Micrel disclaims any express or implied warranty relating to the sale and/or use of Micrel products including liability or warranties relating to fitness for a particular purpose, merchantability, or infringement of any patent, copyright or other intellectual property right.

Micrel Products are not designed or authorized for use as components in life support appliances, devices or systems where malfunction of a product can reasonably be expected to result in personal injury. Life support devices or systems are devices or systems that (a) are intended for surgical implant into the body or (b) support or sustain life, and whose failure to perform can be reasonably expected to result in a significant injury to the user. A Purchaser's use or sale of Micrel Products for use in life support appliances, devices or systems is a Purchaser's own risk and Purchaser agrees to fully indemnify Micrel for any damages resulting from such use or sale.

© 2009 Micrel, Incorporated.





## Стандарт Электрон Связь

Мы молодая и активно развивающаяся компания в области поставок электронных компонентов. Мы поставляем электронные компоненты отечественного и импортного производства напрямую от производителей и с крупнейших складов мира.

Благодаря сотрудничеству с мировыми поставщиками мы осуществляем комплексные и плановые поставки широчайшего спектра электронных компонентов.

Собственная эффективная логистика и склад в обеспечивает надежную поставку продукции в точно указанные сроки по всей России.

Мы осуществляем техническую поддержку нашим клиентам и предпродажную проверку качества продукции. На все поставляемые продукты мы предоставляем гарантию .

Осуществляем поставки продукции под контролем ВП МО РФ на предприятия военно-промышленного комплекса России , а также работаем в рамках 275 ФЗ с открытием отдельных счетов в уполномоченном банке. Система менеджмента качества компании соответствует требованиям ГОСТ ISO 9001.

Минимальные сроки поставки, гибкие цены, неограниченный ассортимент и индивидуальный подход к клиентам являются основой для выстраивания долгосрочного и эффективного сотрудничества с предприятиями радиоэлектронной промышленности, предприятиями ВПК и научно-исследовательскими институтами России.

С нами вы становитесь еще успешнее!

### Наши контакты:

**Телефон:** +7 812 627 14 35

**Электронная почта:** [sales@st-electron.ru](mailto:sales@st-electron.ru)

**Адрес:** 198099, Санкт-Петербург,  
Промышленная ул, дом № 19, литера Н,  
помещение 100-Н Офис 331