

MUN2240, MMUN2240L, MUN5240, DTC144TE, DTC144TM3, NSBC144TF3

Digital Transistors (BRT) R1 = 47 kΩ, R2 = ∞ kΩ

NPN Transistors with Monolithic Bias Resistor Network

This series of digital transistors is designed to replace a single device and its external resistor bias network. The Bias Resistor Transistor (BRT) contains a single transistor with a monolithic bias network consisting of two resistors; a series base resistor and a base-emitter resistor. The BRT eliminates these individual components by integrating them into a single device. The use of a BRT can reduce both system cost and board space.

Features

- Simplifies Circuit Design
- Reduces Board Space
- Reduces Component Count
- S and NSV Prefix for Automotive and Other Applications Requiring Unique Site and Control Change Requirements; AEC-Q101 Qualified and PPAP Capable
- These Devices are Pb-Free, Halogen Free/BFR Free and are RoHS Compliant

MAXIMUM RATINGS (T_A = 25°C)

| Rating | Symbol | Max | Unit |
|--------------------------------|----------------------|-----|------|
| Collector-Base Voltage | V _{CBO} | 50 | Vdc |
| Collector-Emitter Voltage | V _{CEO} | 50 | Vdc |
| Collector Current - Continuous | I _C | 100 | mAdc |
| Input Forward Voltage | V _{IN(fwd)} | 40 | Vdc |
| Input Reverse Voltage | V _{IN(rev)} | 6 | Vdc |

Stresses exceeding those listed in the Maximum Ratings table may damage the device. If any of these limits are exceeded, device functionality should not be assumed, damage may occur and reliability may be affected.



ON Semiconductor®

<http://onsemi.com>

PIN CONNECTIONS

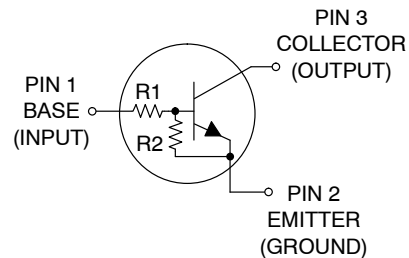

MARKING DIAGRAMS

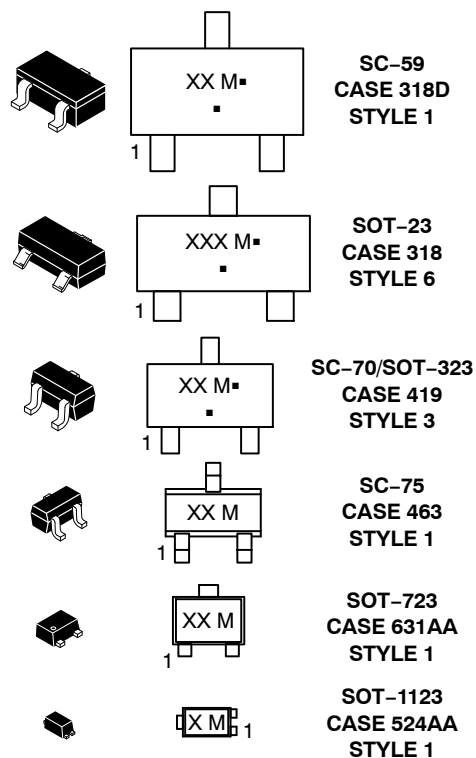

XXX = Specific Device Code
M = Date Code*
▪ = Pb-Free Package

(Note: Microdot may be in either location)

*Date Code orientation may vary depending upon manufacturing location.

ORDERING INFORMATION

See detailed ordering, marking, and shipping information in the package dimensions section on page 2 of this data sheet.

MUN2240, MMUN2240L, MUN5240, DTC144TE, DTC144TM3, NSBC144TF3

Table 1. ORDERING INFORMATION

| Device | Part Marking | Package | Shipping† |
|-------------------------------|--------------|----------------------------|--------------------|
| MUN2240T1G, SMUN2240T1G | 8T | SC-59 (Pb-Free) | 3000 / Tape & Reel |
| MMUN2240LT1G | AA4 | SOT-23 (Pb-Free) | 3000 / Tape & Reel |
| MUN5240T1G | AR | SC-70/SOT-323 (Pb-Free) | 3000 / Tape & Reel |
| DTC144TET1G | 7T | SC-75 (Pb-Free) | 3000 / Tape & Reel |
| DTC144TM3T5G, NSVDTC144TM3T5G | 8T | SOT-723 (Pb-Free) | 8000 / Tape & Reel |
| NSBC144TF3T5G | K (180°) | SOT-1123 (Pb-Free) | 8000 / Tape & Reel |

†For information on tape and reel specifications, including part orientation and tape sizes, please refer to our Tape and Reel Packaging Specifications Brochure, BRD8011/D.

* (xx°) = Degree rotation in the clockwise direction.

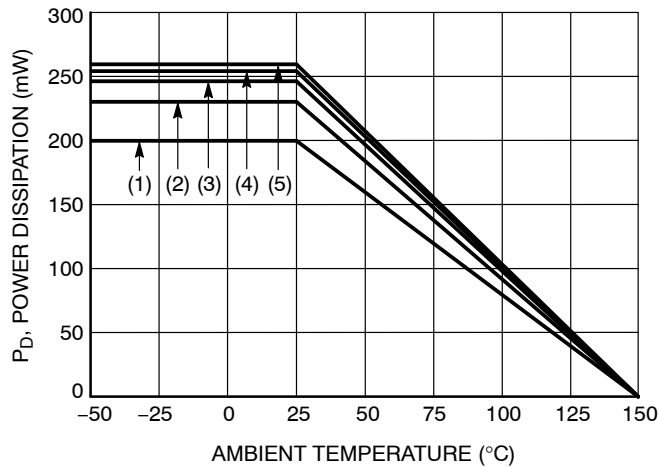

- (1) SC-75 and SC-70/SOT323; Minimum Pad
- (2) SC-59; Minimum Pad
- (3) SOT-23; Minimum Pad
- (4) SOT-1123; 100 mm², 1 oz. copper trace
- (5) SOT-723; Minimum Pad

Figure 1. Derating Curve

MUN2240, MMUN2240L, MUN5240, DTC144TE, DTC144TM3, NSBC144TF3

Table 2. THERMAL CHARACTERISTICS

| Characteristic | Symbol | Max | Unit |
|---|--|-----------------------------------|----------------------------|
| THERMAL CHARACTERISTICS (SC-59) (MUN2240) | | | |
| Total Device Dissipation $T_A = 25^\circ\text{C}$ Derate above 25°C | (Note 1) (Note 2) (Note 1) (Note 2) | P_D 230 338 1.8 2.7 | mW mW/ $^\circ\text{C}$ |
| Thermal Resistance, Junction to Ambient | (Note 1) (Note 2) | $R_{\theta JA}$ 540 370 | $^\circ\text{C/W}$ |
| Thermal Resistance, Junction to Lead | (Note 1) (Note 2) | $R_{\theta JL}$ 264 287 | $^\circ\text{C/W}$ |
| Junction and Storage Temperature Range | T_J, T_{stg} | -55 to +150 | $^\circ\text{C}$ |
| THERMAL CHARACTERISTICS (SOT-23) (MMUN2240L) | | | |
| Total Device Dissipation $T_A = 25^\circ\text{C}$ Derate above 25°C | (Note 1) (Note 2) (Note 1) (Note 2) | P_D 246 400 2.0 3.2 | mW mW/ $^\circ\text{C}$ |
| Thermal Resistance, Junction to Ambient | (Note 1) (Note 2) | $R_{\theta JA}$ 508 311 | $^\circ\text{C/W}$ |
| Thermal Resistance, Junction to Lead | (Note 1) (Note 2) | $R_{\theta JL}$ 174 208 | $^\circ\text{C/W}$ |
| Junction and Storage Temperature Range | T_J, T_{stg} | -55 to +150 | $^\circ\text{C}$ |
| THERMAL CHARACTERISTICS (SC-70/SOT-323) (MUN5240) | | | |
| Total Device Dissipation $T_A = 25^\circ\text{C}$ Derate above 25°C | (Note 1) (Note 2) (Note 1) (Note 2) | P_D 202 310 1.6 2.5 | mW mW/ $^\circ\text{C}$ |
| Thermal Resistance, Junction to Ambient | (Note 1) (Note 2) | $R_{\theta JA}$ 618 403 | $^\circ\text{C/W}$ |
| Thermal Resistance, Junction to Lead | (Note 1) (Note 2) | $R_{\theta JL}$ 280 332 | $^\circ\text{C/W}$ |
| Junction and Storage Temperature Range | T_J, T_{stg} | -55 to +150 | $^\circ\text{C}$ |
| THERMAL CHARACTERISTICS (SC-75) (DTC144TE) | | | |
| Total Device Dissipation $T_A = 25^\circ\text{C}$ Derate above 25°C | (Note 1) (Note 2) (Note 1) (Note 2) | P_D 200 300 1.6 2.4 | mW mW/ $^\circ\text{C}$ |
| Thermal Resistance, Junction to Ambient | (Note 1) (Note 2) | $R_{\theta JA}$ 600 400 | $^\circ\text{C/W}$ |
| Junction and Storage Temperature Range | T_J, T_{stg} | -55 to +150 | $^\circ\text{C}$ |
| THERMAL CHARACTERISTICS (SOT-723) (DTC144TM3) | | | |
| Total Device Dissipation $T_A = 25^\circ\text{C}$ Derate above 25°C | (Note 1) (Note 2) (Note 1) (Note 2) | P_D 260 600 2.0 4.8 | mW mW/ $^\circ\text{C}$ |
| Thermal Resistance, Junction to Ambient | (Note 1) (Note 2) | $R_{\theta JA}$ 480 205 | $^\circ\text{C/W}$ |
| Junction and Storage Temperature Range | T_J, T_{stg} | -55 to +150 | $^\circ\text{C}$ |

- FR-4 @ Minimum Pad.
- FR-4 @ 1.0 x 1.0 Inch Pad.
- FR-4 @ 100 mm², 1 oz. copper traces, still air.
- FR-4 @ 500 mm², 1 oz. copper traces, still air.

MUN2240, MMUN2240L, MUN5240, DTC144TE, DTC144TM3, NSBC144TF3

Table 2. THERMAL CHARACTERISTICS

| Characteristic | Symbol | Max | Unit |
|--|-----------------|-------------|----------------------|
| THERMAL CHARACTERISTICS (SOT-1123) (NSBC144TF3) | | | |
| Total Device Dissipation $T_A = 25^\circ\text{C}$ | P_D | 254 297 | mW |
| Derate above 25°C | | 2.0 2.4 | mW/ $^\circ\text{C}$ |
| Thermal Resistance, Junction to Ambient | $R_{\theta JA}$ | 493 421 | $^\circ\text{C/W}$ |
| Thermal Resistance, Junction to Lead | $R_{\theta JL}$ | 193 | $^\circ\text{C/W}$ |
| Junction and Storage Temperature Range | T_J, T_{stg} | -55 to +150 | $^\circ\text{C}$ |

- FR-4 @ Minimum Pad.
- FR-4 @ 1.0 x 1.0 Inch Pad.
- FR-4 @ 100 mm², 1 oz. copper traces, still air.
- FR-4 @ 500 mm², 1 oz. copper traces, still air.

Table 3. ELECTRICAL CHARACTERISTICS ($T_A = 25^\circ\text{C}$, unless otherwise noted)

| Characteristic | Symbol | Min | Typ | Max | Unit |
|--|---------------|------|-----|------|------------|
| OFF CHARACTERISTICS | | | | | |
| Collector-Base Cutoff Current ($V_{CB} = 50\text{ V}, I_E = 0$) | I_{CBO} | - | - | 100 | nAdc |
| Collector-Emitter Cutoff Current ($V_{CE} = 50\text{ V}, I_B = 0$) | I_{CEO} | - | - | 500 | nAdc |
| Emitter-Base Cutoff Current ($V_{EB} = 6.0\text{ V}, I_C = 0$) | I_{EBO} | - | - | 0.2 | mAdc |
| Collector-Base Breakdown Voltage ($I_C = 10\ \mu\text{A}, I_E = 0$) | $V_{(BR)CBO}$ | 50 | - | - | Vdc |
| Collector-Emitter Breakdown Voltage (Note 5) ($I_C = 2.0\text{ mA}, I_B = 0$) | $V_{(BR)CEO}$ | 50 | - | - | Vdc |
| ON CHARACTERISTICS | | | | | |
| DC Current Gain (Note 5) ($I_C = 5.0\text{ mA}, V_{CE} = 10\text{ V}$) | h_{FE} | 120 | 300 | - | |
| Collector-Emitter Saturation Voltage (Note 5) ($I_C = 10\text{ mA}, I_B = 1.0\text{ mA}$) | $V_{CE(sat)}$ | - | - | 0.25 | Vdc |
| Input Voltage (off) ($V_{CE} = 5.0\text{ V}, I_C = 100\ \mu\text{A}$) | $V_{i(off)}$ | - | 0.6 | 0.5 | Vdc |
| Input Voltage (on) ($V_{CE} = 0.3\text{ V}, I_C = 10\text{ mA}$) | $V_{i(on)}$ | 4.0 | 2.6 | - | Vdc |
| Output Voltage (on) ($V_{CC} = 5.0\text{ V}, V_B = 3.5\text{ V}, R_L = 1.0\text{ k}\Omega$) | V_{OL} | - | - | 0.2 | Vdc |
| Output Voltage (off) ($V_{CC} = 5.0\text{ V}, V_B = 0.25\text{ V}, R_L = 1.0\text{ k}\Omega$) | V_{OH} | 4.9 | - | - | Vdc |
| Input Resistor | R1 | 32.9 | 47 | 61.1 | k Ω |

Product parametric performance is indicated in the Electrical Characteristics for the listed test conditions, unless otherwise noted. Product performance may not be indicated by the Electrical Characteristics if operated under different conditions.

- Pulsed Condition: Pulse Width = 300 msec, Duty Cycle \leq 2%.

TYPICAL CHARACTERISTICS – MUN2240, MMUN2240L, MUN5240, DTC144TE, DTC144TM3

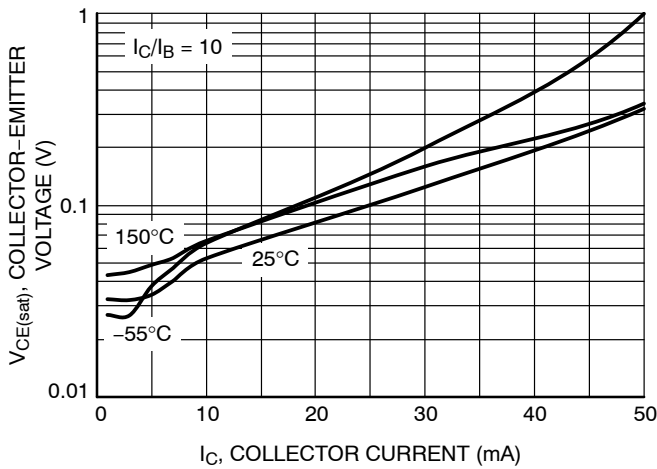

Figure 2. $V_{CE(sat)}$ vs. I_C

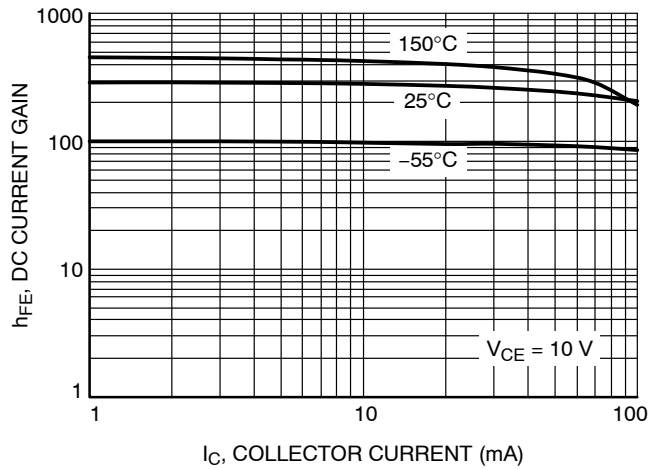

Figure 3. DC Current Gain

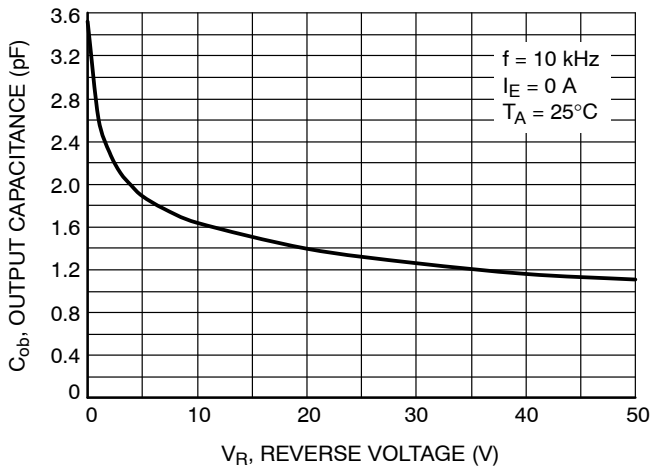

Figure 4. Output Capacitance

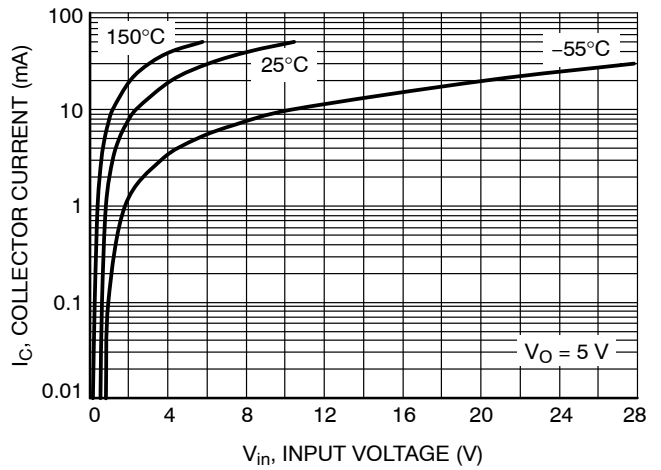

Figure 5. Output Current vs. Input Voltage

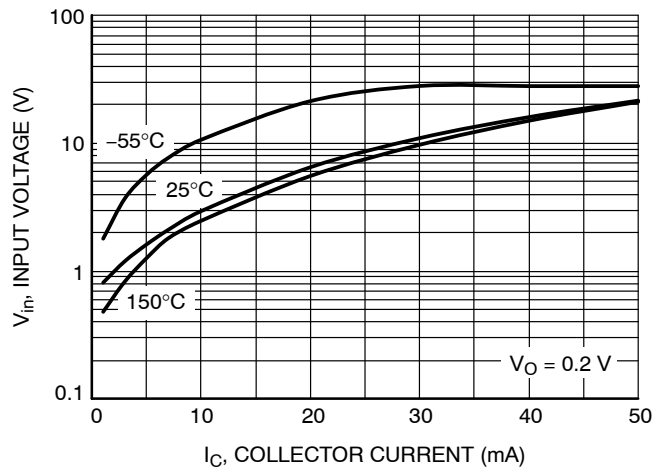
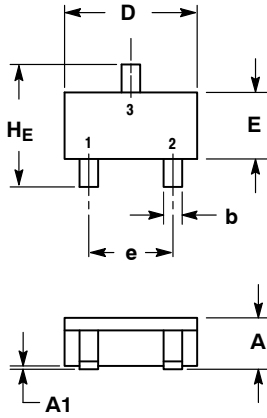

Figure 6. Input Voltage vs. Output Current

PACKAGE DIMENSIONS

SC-59
CASE 318D-04
ISSUE H



NOTES:
1. DIMENSIONING AND TOLERANCING PER ANSI Y14.5M, 1982.
2. CONTROLLING DIMENSION: MILLIMETER.

| DIM | MILLIMETERS | | | INCHES | | |
|-----|-------------|------|------|--------|-------|-------|
| | MIN | NOM | MAX | MIN | NOM | MAX |
| A | 1.00 | 1.15 | 1.30 | 0.039 | 0.045 | 0.051 |
| A1 | 0.01 | 0.06 | 0.10 | 0.001 | 0.002 | 0.004 |
| b | 0.35 | 0.43 | 0.50 | 0.014 | 0.017 | 0.020 |
| c | 0.09 | 0.14 | 0.18 | 0.003 | 0.005 | 0.007 |
| D | 2.70 | 2.90 | 3.10 | 0.106 | 0.114 | 0.122 |
| E | 1.30 | 1.50 | 1.70 | 0.051 | 0.059 | 0.067 |
| e | 1.70 | 1.90 | 2.10 | 0.067 | 0.075 | 0.083 |
| L | 0.20 | 0.40 | 0.60 | 0.008 | 0.016 | 0.024 |
| HE | 2.50 | 2.80 | 3.00 | 0.099 | 0.110 | 0.118 |

STYLE 1:
PIN 1. BASE
2. EMITTER
3. COLLECTOR

SOLDERING FOOTPRINT*

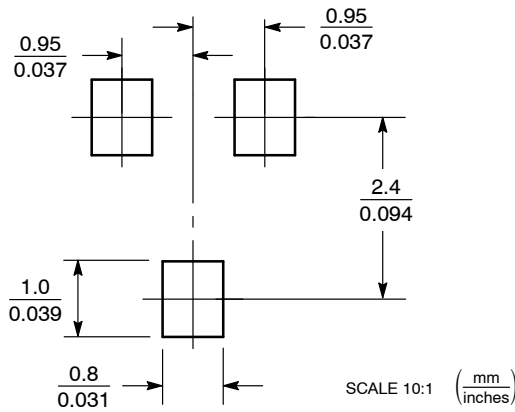

*For additional information on our Pb-Free strategy and soldering details, please download the ON Semiconductor Soldering and Mounting Techniques Reference Manual, SOLDERRM/D.

PACKAGE DIMENSIONS

SOT-23 (TO-236)
CASE 318-08
ISSUE AP

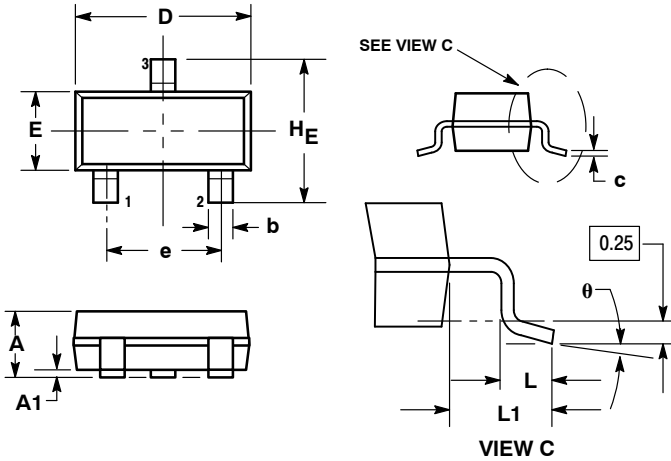

- NOTES:
1. DIMENSIONING AND TOLERANCING PER ANSI Y14.5M, 1982.
 2. CONTROLLING DIMENSION: INCH.
 3. MAXIMUM LEAD THICKNESS INCLUDES LEAD FINISH THICKNESS. MINIMUM LEAD THICKNESS IS THE MINIMUM THICKNESS OF BASE MATERIAL.
 4. DIMENSIONS D AND E DO NOT INCLUDE MOLD FLASH, PROTRUSIONS, OR GATE BURRS.

| DIM | MILLIMETERS | | | INCHES | | |
|-----|-------------|------|------|--------|-------|-------|
| | MIN | NOM | MAX | MIN | NOM | MAX |
| A | 0.89 | 1.00 | 1.11 | 0.035 | 0.040 | 0.044 |
| A1 | 0.01 | 0.06 | 0.10 | 0.001 | 0.002 | 0.004 |
| b | 0.37 | 0.44 | 0.50 | 0.015 | 0.018 | 0.020 |
| c | 0.09 | 0.13 | 0.18 | 0.003 | 0.005 | 0.007 |
| D | 2.80 | 2.90 | 3.04 | 0.110 | 0.114 | 0.120 |
| E | 1.20 | 1.30 | 1.40 | 0.047 | 0.051 | 0.055 |
| e | 1.78 | 1.90 | 2.04 | 0.070 | 0.075 | 0.081 |
| L | 0.10 | 0.20 | 0.30 | 0.004 | 0.008 | 0.012 |
| L1 | 0.35 | 0.54 | 0.69 | 0.014 | 0.021 | 0.029 |
| HE | 2.10 | 2.40 | 2.64 | 0.083 | 0.094 | 0.104 |
| θ | 0° | --- | 10° | 0° | --- | 10° |

STYLE 6:
PIN 1. BASE
2. EMITTER
3. COLLECTOR

SOLDERING FOOTPRINT*

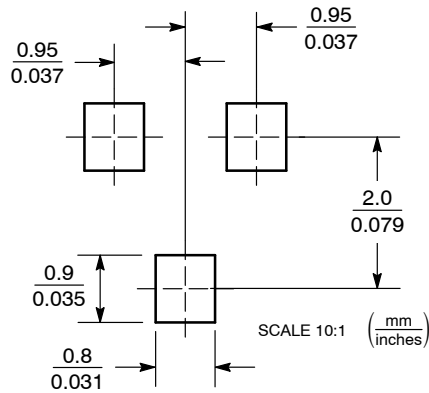

*For additional information on our Pb-Free strategy and soldering details, please download the ON Semiconductor Soldering and Mounting Techniques Reference Manual, SOLDERRM/D.

PACKAGE DIMENSIONS

SC-70 (SOT-323)
CASE 419-04
ISSUE N

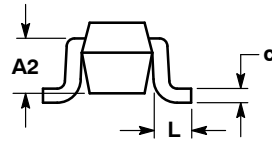
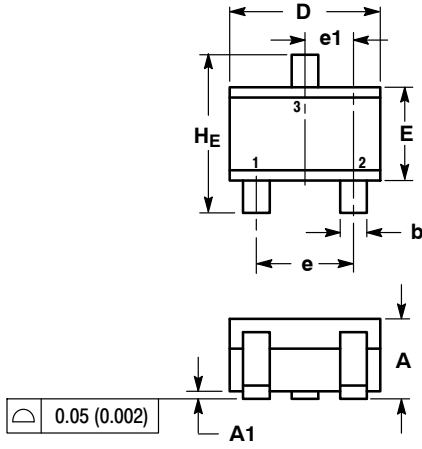

NOTES:

1. DIMENSIONING AND TOLERANCING PER ANSI Y14.5M, 1982.
2. CONTROLLING DIMENSION: INCH.

| DIM | MILLIMETERS | | | INCHES | | |
|-----|-------------|------|------|-----------|-------|-------|
| | MIN | NOM | MAX | MIN | NOM | MAX |
| A | 0.80 | 0.90 | 1.00 | 0.032 | 0.035 | 0.040 |
| A1 | 0.00 | 0.05 | 0.10 | 0.000 | 0.002 | 0.004 |
| A2 | 0.70 REF | | | 0.028 REF | | |
| b | 0.30 | 0.35 | 0.40 | 0.012 | 0.014 | 0.016 |
| c | 0.10 | 0.18 | 0.25 | 0.004 | 0.007 | 0.010 |
| D | 1.80 | 2.10 | 2.20 | 0.071 | 0.083 | 0.087 |
| E | 1.15 | 1.24 | 1.35 | 0.045 | 0.049 | 0.053 |
| e | 1.20 | 1.30 | 1.40 | 0.047 | 0.051 | 0.055 |
| e1 | 0.65 BSC | | | 0.026 BSC | | |
| L | 0.20 | 0.38 | 0.56 | 0.008 | 0.015 | 0.022 |
| HE | 2.00 | 2.10 | 2.40 | 0.079 | 0.083 | 0.095 |

- STYLE 3:
PIN 1. BASE
2. EMITTER
3. COLLECTOR

SOLDERING FOOTPRINT*

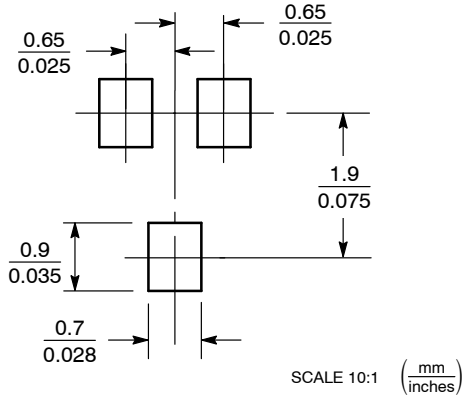

*For additional information on our Pb-Free strategy and soldering details, please download the ON Semiconductor Soldering and Mounting Techniques Reference Manual, SOLDERRM/D.

PACKAGE DIMENSIONS

SC-75/SOT-416
CASE 463
ISSUE F

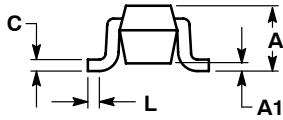
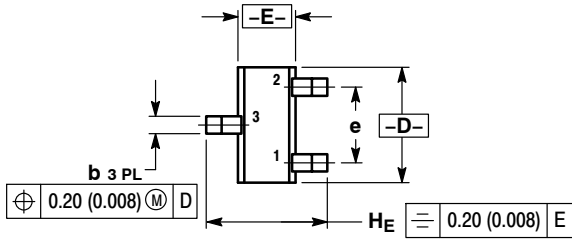

NOTES:
1. DIMENSIONING AND TOLERANCING PER ANSI Y14.5M, 1982.
2. CONTROLLING DIMENSION: MILLIMETER.

| DIM | MILLIMETERS | | | INCHES | | |
|-----|-------------|------|------|----------|-------|-------|
| | MIN | NOM | MAX | MIN | NOM | MAX |
| A | 0.70 | 0.80 | 0.90 | 0.027 | 0.031 | 0.035 |
| A1 | 0.00 | 0.05 | 0.10 | 0.000 | 0.002 | 0.004 |
| b | 0.15 | 0.20 | 0.30 | 0.006 | 0.008 | 0.012 |
| C | 0.10 | 0.15 | 0.25 | 0.004 | 0.006 | 0.010 |
| D | 1.55 | 1.60 | 1.65 | 0.059 | 0.063 | 0.067 |
| E | 0.70 | 0.80 | 0.90 | 0.027 | 0.031 | 0.035 |
| e | 1.00 BSC | | | 0.04 BSC | | |
| L | 0.10 | 0.15 | 0.20 | 0.004 | 0.006 | 0.008 |
| HE | 1.50 | 1.60 | 1.70 | 0.061 | 0.063 | 0.065 |

STYLE 1:
PIN 1. BASE
2. EMITTER
3. COLLECTOR

SOLDERING FOOTPRINT*

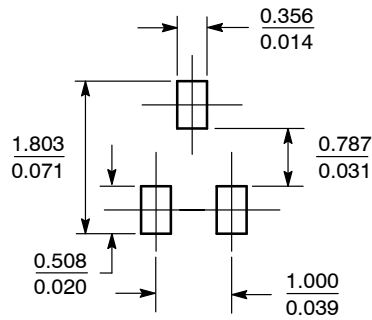

SCALE 10:1 (mm/inches)

*For additional information on our Pb-Free strategy and soldering details, please download the ON Semiconductor Soldering and Mounting Techniques Reference Manual, SOLDERRM/D.

PACKAGE DIMENSIONS

SOT-723
CASE 631AA
ISSUE D

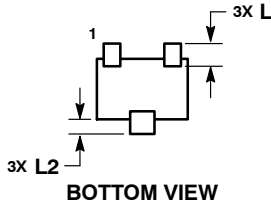
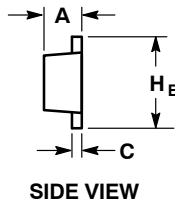
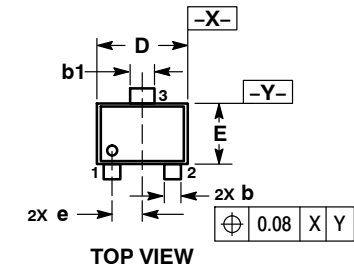

NOTES:

1. DIMENSIONING AND TOLERANCING PER ASME Y14.5M, 1994.
2. CONTROLLING DIMENSION: MILLIMETERS.
3. MAXIMUM LEAD THICKNESS INCLUDES LEAD FINISH. MINIMUM LEAD THICKNESS IS THE MINIMUM THICKNESS OF BASE MATERIAL.
4. DIMENSIONS D AND E DO NOT INCLUDE MOLD FLASH, PROTRUSIONS OR GATE BURRS.

| DIM | MILLIMETERS | | |
|-----|-------------|------|------|
| | MIN | NOM | MAX |
| A | 0.45 | 0.50 | 0.55 |
| b | 0.15 | 0.21 | 0.27 |
| b1 | 0.25 | 0.31 | 0.37 |
| C | 0.07 | 0.12 | 0.17 |
| D | 1.15 | 1.20 | 1.25 |
| E | 0.75 | 0.80 | 0.85 |
| e | 0.40 BSC | | |
| H E | 1.15 | 1.20 | 1.25 |
| L | 0.29 REF | | |
| L2 | 0.15 | 0.20 | 0.25 |

STYLE 1:

- PIN 1. BASE
2. EMITTER
3. COLLECTOR

RECOMMENDED
SOLDERING FOOTPRINT*

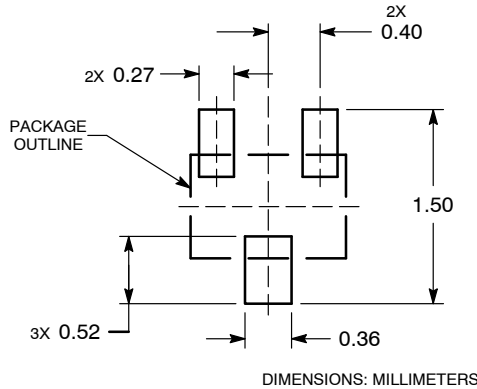

*For additional information on our Pb-Free strategy and soldering details, please download the ON Semiconductor Soldering and Mounting Techniques Reference Manual, SOLDERRM/D.

PACKAGE DIMENSIONS

SOT-1123
CASE 524AA
ISSUE C

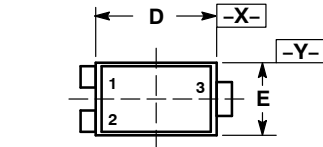

TOP VIEW

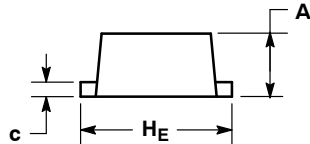

SIDE VIEW

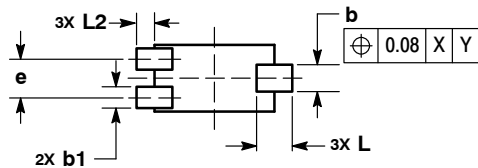

BOTTOM VIEW

SOLDERING FOOTPRINT*

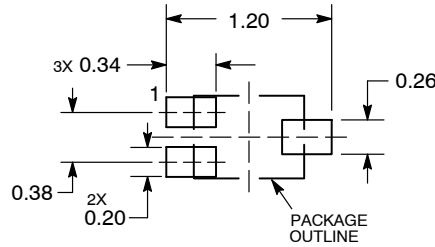

DIMENSIONS: MILLIMETERS

NOTES:

1. DIMENSIONING AND TOLERANCING PER ASME Y14.5M, 1994.
2. CONTROLLING DIMENSION: MILLIMETERS.
3. MAXIMUM LEAD THICKNESS INCLUDES LEAD FINISH. MINIMUM LEAD THICKNESS IS THE MINIMUM THICKNESS OF BASE MATERIAL.
4. DIMENSIONS D AND E DO NOT INCLUDE MOLD FLASH, PROTRUSIONS, OR GATE BURRS.

| DIM | MILLIMETERS | |
|----------------|-------------|------|
| | MIN | MAX |
| A | 0.34 | 0.40 |
| b | 0.15 | 0.28 |
| b1 | 0.10 | 0.20 |
| c | 0.07 | 0.17 |
| D | 0.75 | 0.85 |
| E | 0.55 | 0.65 |
| e | 0.35 | 0.40 |
| H _E | 0.95 | 1.05 |
| L | 0.185 | REF |
| L2 | 0.05 | 0.15 |

STYLE 1:

1. BASE
2. EMITTER
3. COLLECTOR

*For additional information on our Pb-Free strategy and soldering details, please download the ON Semiconductor Soldering and Mounting Techniques Reference Manual, SOLDERRM/D.

ON Semiconductor and are registered trademarks of Semiconductor Components Industries, LLC (SCILLC). SCILLC owns the rights to a number of patents, trademarks, copyrights, trade secrets, and other intellectual property. A listing of SCILLC's product/patent coverage may be accessed at www.onsemi.com/site/pdf/Patent-Marking.pdf. SCILLC reserves the right to make changes without further notice to any products herein. SCILLC makes no warranty, representation or guarantee regarding the suitability of its products for any particular purpose, nor does SCILLC assume any liability arising out of the application or use of any product or circuit, and specifically disclaims any and all liability, including without limitation special, consequential or incidental damages. "Typical" parameters which may be provided in SCILLC data sheets and/or specifications can and do vary in different applications and actual performance may vary over time. All operating parameters, including "Typicals" must be validated for each customer application by customer's technical experts. SCILLC does not convey any license under its patent rights nor the rights of others. SCILLC products are not designed, intended, or authorized for use as components in systems intended for surgical implant into the body, or other applications intended to support or sustain life, or for any other application in which the failure of the SCILLC product could create a situation where personal injury or death may occur. Should Buyer purchase or use SCILLC products for any such unintended or unauthorized application, Buyer shall indemnify and hold SCILLC and its officers, employees, subsidiaries, affiliates, and distributors harmless against all claims, costs, damages, and expenses, and reasonable attorney fees arising out of, directly or indirectly, any claim of personal injury or death associated with such unintended or unauthorized use, even if such claim alleges that SCILLC was negligent regarding the design or manufacture of the part. SCILLC is an Equal Opportunity/Affirmative Action Employer. This literature is subject to all applicable copyright laws and is not for resale in any manner.

PUBLICATION ORDERING INFORMATION

LITERATURE FULFILLMENT:
Literature Distribution Center for ON Semiconductor
P.O. Box 5163, Denver, Colorado 80217 USA
Phone: 303-675-2175 or 800-344-3860 Toll Free USA/Canada
Fax: 303-675-2176 or 800-344-3867 Toll Free USA/Canada
Email: orderlit@onsemi.com

N. American Technical Support: 800-282-9855 Toll Free
USA/Canada
Europe, Middle East and Africa Technical Support:
Phone: 421 33 790 2910
Japan Customer Focus Center
Phone: 81-3-5817-1050

ON Semiconductor Website: www.onsemi.com
Order Literature: <http://www.onsemi.com/orderlit>
For additional information, please contact your local Sales Representative



Стандарт Электрон Связь

Мы молодая и активно развивающаяся компания в области поставок электронных компонентов. Мы поставляем электронные компоненты отечественного и импортного производства напрямую от производителей и с крупнейших складов мира.

Благодаря сотрудничеству с мировыми поставщиками мы осуществляем комплексные и плановые поставки широчайшего спектра электронных компонентов.

Собственная эффективная логистика и склад в обеспечивает надежную поставку продукции в точно указанные сроки по всей России.

Мы осуществляем техническую поддержку нашим клиентам и предпродажную проверку качества продукции. На все поставляемые продукты мы предоставляем гарантию .

Осуществляем поставки продукции под контролем ВП МО РФ на предприятия военно-промышленного комплекса России , а также работаем в рамках 275 ФЗ с открытием отдельных счетов в уполномоченном банке. Система менеджмента качества компании соответствует требованиям ГОСТ ISO 9001.

Минимальные сроки поставки, гибкие цены, неограниченный ассортимент и индивидуальный подход к клиентам являются основой для выстраивания долгосрочного и эффективного сотрудничества с предприятиями радиоэлектронной промышленности, предприятиями ВПК и научно-исследовательскими институтами России.

С нами вы становитесь еще успешнее!

Наши контакты:

Телефон: +7 812 627 14 35

Электронная почта: sales@st-electron.ru

Адрес: 198099, Санкт-Петербург,
Промышленная ул, дом № 19, литера Н,
помещение 100-Н Офис 331