

Synchronous Buck Converter Integrated FET

BD9106FVM BD9107FVM BD9109FVM BD9110NV BD9120HFN

●General Description

ROHM's high efficiency step-down switching regulators (BD9106FVM, BD9107FVM, BD9109FVM, BD9110NV, BD9120HFN) are the power supply designed to produce a low voltage including 1 volts from 5/3.3 volts power supply line. Offers high efficiency with our original pulse skip control technology and synchronous rectifier. Employs a current mode control system to provide faster transient response to sudden change in load.

●Features

- Offers fast transient response with current mode PWM control system.
- Offers highly efficiency for all load range with synchronous rectifier (Nch/Pch FET) and SLLM™ (Simple Light Load Mode) Incorporates soft-start function.
- Incorporates thermal protection and ULVO functions.
- Incorporates short-current protection circuit with time delay function.
- Incorporates shutdown function

●Application

Power supply for LSI including DSP, Micro computer and ASIC

●Typical Application Circuit

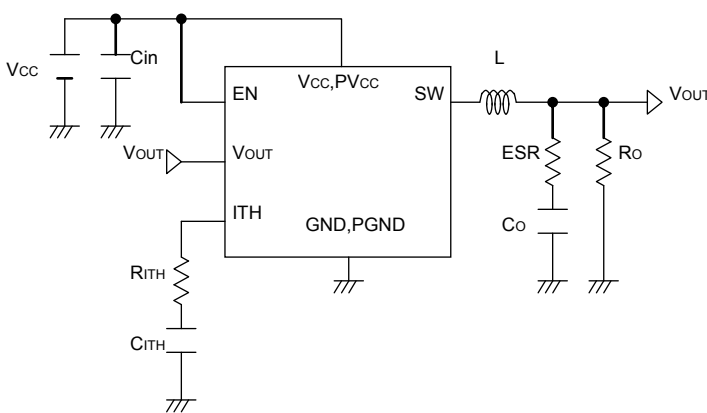

Fig.1 Typical Application Circuit

●Key Specifications

- Input voltage range

BD9120HFN:	2.7V to 4.5V
BD9106FVM, BD9107FVM:	4.0V to 5.5V
BD9109FVM, BD9110NV:	4.5V to 5.5V
- Output voltage range

BD9109FVM:	3.30V ± 2%
BD9120HFN:	1.0V to 1.5V
BD9107FVM:	1.0V to 1.8V
BD9106FVM, BD9110NV:	1.0V to 2.5V
- Output current

BD9106FVM, BD9109FVM, BD9120HFN:	0.8A(Max.)
BD9107FVM:	1.2A(Max.)
BD9110NV:	2.0A(Max.)
- Switching frequency: 1MHz(Typ.)
- FET ON resistance

	Pch(Typ.) / Nch(Typ.)
BD9110NV:	200mΩ / 150mΩ
BD9106FVM, BD9107FVM:	350mΩ / 250mΩ
BD9120HFN, BD9109FVM:	350mΩ / 250mΩ
- Standby current: 0μA(Typ.)
- Operating temperature range

BD9110NV:	-25°C to +105°C
BD9120HFN, BD9106FVM:	-25°C to +85°C
BD9107FVM, BD9109FVM:	-25°C to +85°C

●Packages

	(Typ.)	(Typ.)	(Max.)
HSO8	2.90mm	3.00mm	0.60mm
MSOP8	2.90mm	4.00mm	0.90mm
SON008V5060	5.00mm	6.00mm	1.00mm

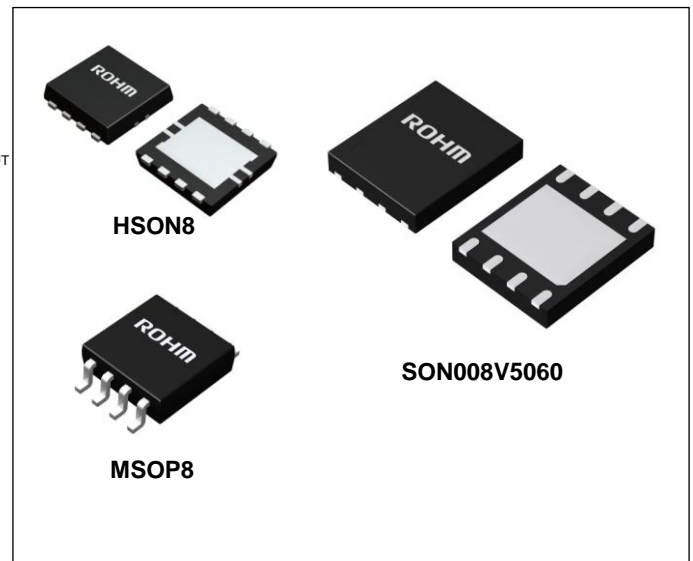

●Pin Configurations

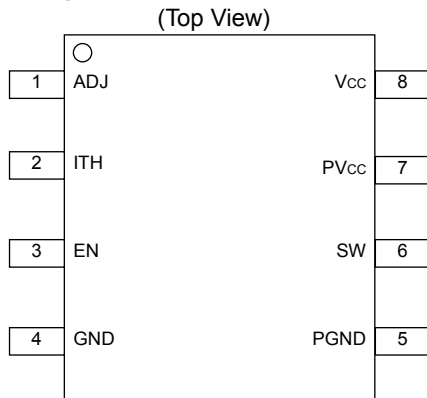

Fig.2 BD9106FVM, BD9107FVM

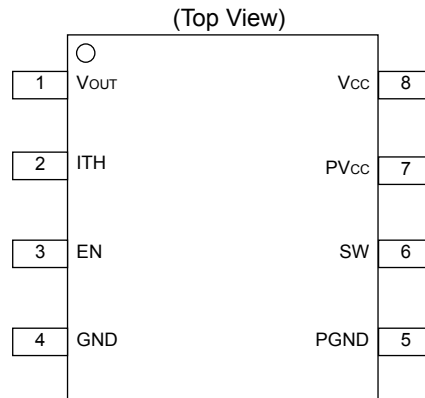

Fig.3 BD9109FVM

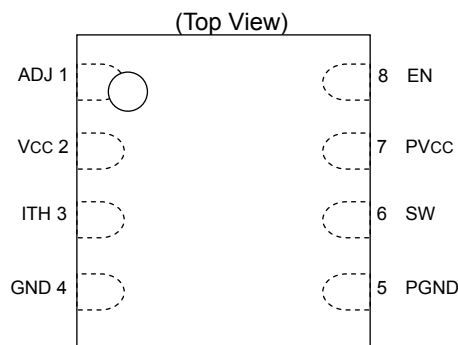

Fig.4 BD9110NV

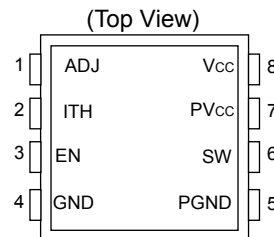

Fig.5 BD9120HFN

●Pin Descriptions

【BD9106FVM, BD9107FVM, BD9109FVM】

Pin No.	Pin name	PIN function
1	ADJ/VOUT	Output voltage detect pin/ ADJ for BD9106·07FVM
2	ITH	GmAmp output pin/Connected phase compensation capacitor
3	EN	Enable pin(Active High)
4	GND	Ground
5	PGND	Nch FET source pin
6	SW	Pch/Nch FET drain output pin
7	PVcc	Pch FET source pin
8	Vcc	Vcc power supply input pin

【BD9110NV】

Pin No.	Pin name	PIN function
1	ADJ	Output voltage adjust pin
2	Vcc	Vcc power supply input pin
3	ITH	GmAmp output pin/Connected phase compensation capacitor
4	GND	Ground
5	PGND	Nch FET source pin
6	SW	Pch/Nch FET drain output pin
7	PVcc	Pch FET source pin
8	EN	Enable pin(Active High)

【BD9120HFN】

Pin No.	Pin name	PIN function
1	ADJ	Output voltage adjust pin
2	ITH	GmAmp output pin/Connected phase compensation capacitor
3	EN	Enable pin(Active High)
4	GND	Ground
5	PGND	Nch FET source pin
6	SW	Pch/Nch FET drain output pin
7	PVcc	Pch FET source pin
8	Vcc	Vcc power supply input pin

●Ordering Information

B D 9 1 x x x x	-	x x
Part Number	Package NV:SON008V5060 HFN:HSO8 FVM:MSOP8	Packaging and forming specification E2: Embossed tape and reel TR: Embossed tape and reel

●Lineup

Operating Temperature Range	Input voltage range	Output voltage range	Output Current (Max.)	UVLO Threshold voltage (Typ.)	Package		Orderable Part Number
-25°C to +85°C	4.0V to 5.5V	Adjustable (1.0 to 2.5V)	0.8A	3.4V	MSOP8	Reel of 3000	BD9106FVM-TR
		Adjustable (1.0 to 1.8V)	1.2A	2.7V	MSOP8	Reel of 3000	BD9107FVM-TR
	4.5V to 5.5V	3.30±2%	0.8A	3.8V	MSOP8	Reel of 3000	BD9109FVM-TR
	2.7V to 4.5V	Adjustable (1.0 to 1.5V)	0.8A	2.5V	HSO8	Reel of 3000	BD9120HFN-TR
-25°C to +105°C	4.5V to 5.5V	Adjustable (1.0 to 2.5V)	2.0A	3.7V	SON008V5060	Reel of 2000	BD9110NV-E2

●Absolute Maximum Ratings (Ta=25°C)

Parameter	Symbol	Limits			Unit
		BD910xFVM	BD9110NV	BD9120HFN	
Vcc voltage	Vcc	-0.3 to +7 ^{*1}	-0.3 to +7 ^{*1}	-0.3 to +7 ^{*1}	V
PVcc voltage	PVcc	-0.3 to +7 ^{*1}	-0.3 to +7 ^{*1}	-0.3 to +7 ^{*1}	V
EN voltage	EN	-0.3 to +7	-0.3 to +7	-0.3 to +7	V
SW,ITH voltage	SW,ITH	-0.3 to +7	-0.3 to +7	-0.3 to +7	V
Power dissipation 1	Pd1	387.5 ^{*2}	900 ^{*4}	1350 ^{*6}	mW
Power dissipation 2	Pd2	587.4 ^{*3}	3900 ^{*5}	1750 ^{*7}	mW
Operating temperature range	Topr	-25 to +85	-25 to +105	-25 to +85	°C
Storage temperature range	Tstg	-55 to +150	-55 to +150	-55 to +150	°C
Maximum junction temperature	Tjmax	+150	+150	+150	°C

*1 Pd should not be exceeded.

*2 Derating in done 3.1mW/°C for temperatures above Ta=25°C.

*3 Derating in done 4.7mW/°C for temperatures above Ta=25°C, Mounted on 70mm×70mm×1.6mm Glass Epoxy PCB.

*4 Derating in done 7.2mW/°C for temperatures above Ta=25°C, Mounted on 70mm×70mm×1.6mm Glass Epoxy PCB which has 1 layer (3%) of copper on the back side).

*5 Derating in done 31.2mW/°C for temperatures above Ta=25°C, Mounted on a board according to JESD51-7.

*6 Derating in done 10.8mW/°C for temperatures above Ta=25°C, Mounted on 70mm×70mm×1.6mm Glass Epoxy PCB which has 1 layer (7%) of copper on the back side).

*7 Derating in done 14mW/°C for temperatures above Ta=25°C, Mounted on 70mm×70mm×1.6mm Glass Epoxy PCB which has 1 layer (6.5%) of copper on the back side).

●Recommended Operating Ratings (Ta=25°C)

Parameter	Symbol	BD9106FVM		BD9107FVM		BD9109FVM		BD9110NV		BD9120HFN		Unit
		Min.	Max.	Min.	Max.	Min.	Max.	Min.	Max.	Min.	Max.	
Vcc voltage	Vcc ^{*8}	4.0	5.5	4.0	5.5	4.5	5.5	4.5	5.5	2.7	4.5	V
PVcc voltage	PVcc ^{*8}	4.0	5.5	4.0	5.5	4.5	5.5	4.5	5.5	2.7	4.5	V
EN voltage	EN	0	Vcc	0	Vcc	0	Vcc	0	Vcc	0	Vcc	V
SW average output current	Isw ^{*8}	-	0.8	-	1.2	-	0.8	-	2.0	-	0.8	A

*8 Pd should not be exceeded.

● Electrical Characteristics

©BD9106FVM (Ta=25°C, Vcc=5V, EN=Vcc, R1=20kΩ, R2=10kΩ unless otherwise specified.)

Parameter	Symbol	Min.	Typ.	Max.	Unit	Conditions
Standby current	ISTB	-	0	10	μA	EN=GND
Bias current	ICC	-	250	400	μA	
EN Low voltage	VENL	-	GND	0.8	V	Standby mode
EN High voltage	VENH	2.0	VCC	-	V	Active mode
EN input current	IEN	-	1	10	μA	VEN=5V
Oscillation frequency	FOSC	0.8	1	1.2	MHz	
Pch FET ON resistance ^{*9}	RONP	-	0.35	0.60	Ω	PVcc=5V
Nch FET ON resistance ^{*9}	RONN	-	0.25	0.50	Ω	PVcc=5V
ADJ Voltage	VADJ	0.780	0.800	0.820	V	
Output voltage ^{*9}	VOUT	-	1.200	-	V	
ITH sink current	ITHSI	10	20	-	μA	ADJ=H
ITH source current	ITHSO	10	20	-	μA	ADJ=L
UVLO threshold voltage	VUVLOTh	3.2	3.4	3.6	V	Vcc=H→L
UVLO hysteresis voltage	VUVLOHys	50	100	200	mV	
Soft start time	TSS	1.5	3	6	ms	
Timer latch time	TLATCH	0.5	1	2	ms	

*9 Outgoing inspection is not done on all products

©BD9107FVM (Ta=25°C, Vcc=5V, EN=Vcc, R1=20kΩ, R2=10kΩ unless otherwise specified.)

Parameter	Symbol	Min.	Typ.	Max.	Unit	Conditions
Standby current	ISTB	-	0	10	μA	EN=GND
Bias current	ICC	-	250	400	μA	
EN Low voltage	VENL	-	GND	0.8	V	Standby mode
EN High voltage	VENH	2.0	VCC	-	V	Active mode
EN input current	IEN	-	1	10	μA	VEN=5V
Oscillation frequency	FOSC	0.8	1	1.2	MHz	
Pch FET ON resistance ^{*9}	RONP	-	0.35	0.60	Ω	PVcc=5V
Nch FET ON resistance ^{*9}	RONN	-	0.25	0.50	Ω	PVcc=5V
ADJ Voltage	VADJ	0.780	0.800	0.820	V	
Output voltage ^{*9}	VOUT	-	1.200	-	V	
ITH sink current	ITHSI	10	20	-	μA	VOUT =H
ITH source current	ITHSO	10	20	-	μA	VOUT =L
UVLO threshold voltage	VUVLOTh	2.6	2.7	2.8	V	Vcc=H→L
UVLO hysteresis voltage	VUVLOHys	150	300	600	mV	
Soft start time	TSS	0.5	1	2	ms	
Timer latch time	TLATCH	0.5	1	2	ms	

*9 Outgoing inspection is not done on all products

©BD9109FVM (Ta=25°C, Vcc=PVcc=5V, EN=Vcc unless otherwise specified.)

Parameter	Symbol	Min.	Typ.	Max.	Unit	Conditions
Standby current	ISTB	-	0	10	μA	EN=GND
Bias current	ICC	-	250	400	μA	
EN Low voltage	VENL	-	GND	0.8	V	Standby mode
EN High voltage	VENH	2.0	VCC	-	V	Active mode
EN input current	IEN	-	1	10	μA	VEN=5V
Oscillation frequency	FOSC	0.8	1	1.2	MHz	
Pch FET ON resistance ^{*9}	RONP	-	0.35	0.60	Ω	PVcc=5V
Nch FET ON resistance ^{*9}	RONN	-	0.25	0.50	Ω	PVcc=5V
Output voltage	VOUT	3.234	3.300	3.366	V	
ITH sink current	ITHSI	10	20	-	μA	VOUT =H
ITH source current	ITHSO	10	20	-	μA	VOUT =L
UVLO threshold voltage	VUVLO1	3.6	3.8	4.0	V	Vcc=H→L
UVLO hysteresis voltage	VUVLO2	3.65	3.9	4.2	V	Vcc=L→H
Soft start time	TSS	0.5	1	2	ms	
Timer latch time	TLATCH	1	2	3	ms	SCP/TSD operated
Output Short circuit Threshold Voltage	VSCP	-	2	2.7	V	VOUT =H→L

*9 Outgoing inspection is not done on all products

©BD9110NV (Ta=25°C, Vcc=PVcc=5V, EN=Vcc, R1=10kΩ, R2=5kΩ unless otherwise specified.)

Parameter	Symbol	Min.	Typ.	Max.	Unit	Conditions
Standby current	ISTB	-	0	10	μA	EN=GND
Bias current	ICC	-	250	350	μA	
EN Low voltage	VENL	-	GND	0.8	V	Standby mode
EN High voltage	VENH	2.0	Vcc	-	V	Active mode
EN input current	IEN	-	1	10	μA	VEN=5V
Oscillation frequency	FOSC	0.8	1	1.2	MHz	
Pch FET ON resistance *9	RONP	-	200	320	mΩ	PVcc=5V
Nch FET ON resistance *9	RONN	-	150	270	mΩ	PVcc=5V
ADJ Voltage	VADJ	0.780	0.800	0.820	V	
Output voltage *9	VOUT	-	1.200	-	V	
ITH sink current	ITHSI	10	20	-	μA	VOUT =H
ITH source current	ITHSO	10	20	-	μA	VOUT =L
UVLO threshold voltage	VUVLOTh	3.5	3.7	3.9	V	Vcc=H→L
UVLO hysteresis voltage	VUVLOHys	50	100	200	mV	
Soft start time	TSS	2.5	5	10	ms	
Timer latch time	TLATCH	0.5	1	2	ms	

*9 Outgoing inspection is not done on all products

©BD9120HFN (Ta=25°C, Vcc=PVcc=3.3V, EN=Vcc, R1=20kΩ, R2=10kΩ unless otherwise specified.)

Parameter	Symbol	Min.	Typ.	Max.	Unit	Conditions
Standby current	ISTB	-	0	10	μA	EN=GND
Bias current	ICC	-	200	400	μA	
EN Low voltage	VENL	-	GND	0.8	V	Standby mode
EN High voltage	VENH	2.0	Vcc	-	V	Active mode
EN input current	IEN	-	1	10	μA	VEN=3.3V
Oscillation frequency	FOSC	0.8	1	1.2	MHz	
Pch FET ON resistance *9	RONP	-	0.35	0.60	Ω	PVcc=3.3V
Nch FET ON resistance *9	RONN	-	0.25	0.50	Ω	PVcc=3.3V
ADJ Voltage	VADJ	0.780	0.800	0.820	V	
Output voltage *9	VOUT	-	1.200	-	V	
ITH sink current	ITHSI	10	20	-	μA	VOUT =H
ITH source current	ITHSO	10	20	-	μA	VOUT =L
UVLO threshold voltage	VUVLO1	2.400	2.500	2.600	V	Vcc=H→L
UVLO hysteresis voltage	VUVLO2	2.425	2.550	2.700	V	Vcc=L→H
Soft start time	TSS	0.5	1	2	ms	
Timer latch time	TLATCH	1	2	3	ms	SCP/TSD operated
Output Short circuit Threshold Voltage	VSCP	-	VOUT×0.5	VOUT×0.7	V	VOUT =H→L

*9 Outgoing inspection is not done on all products

●Block Diagram

【BD9106FVM, BD9107FVM】

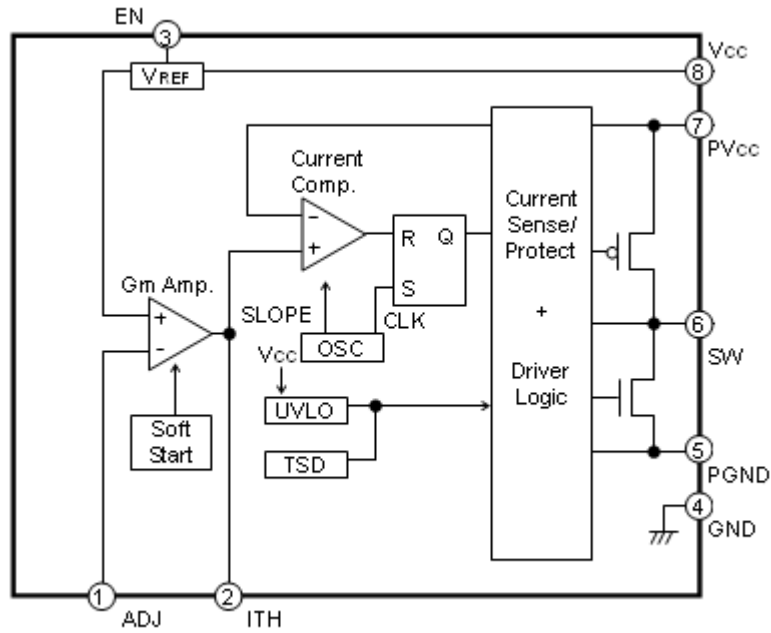

Fig.6 BD9106FVM, BD9107FVM Block Diagram

【BD9109FVM】

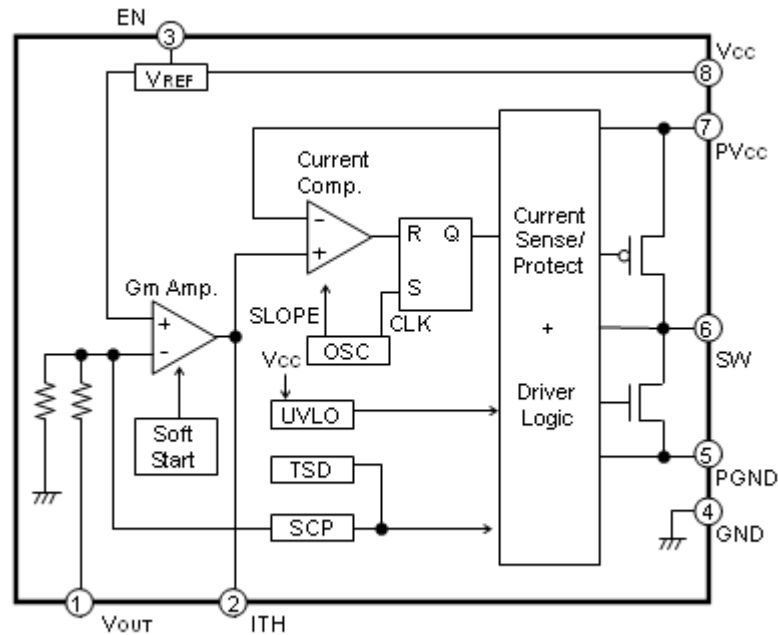

Fig.7 BD9109FVM Block Diagram

【BD9110NV】

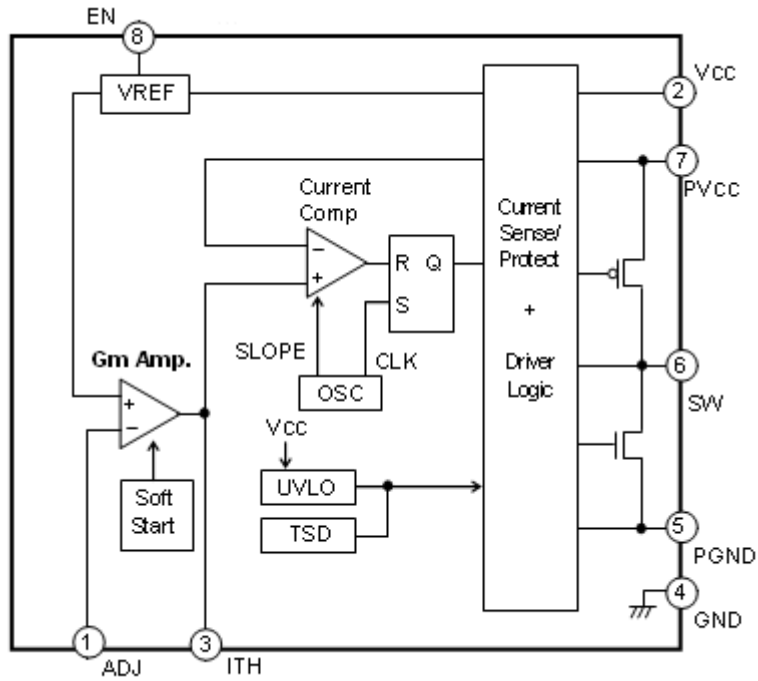

Fig.8 BD9110NV Block Diagram

【BD9120HFN】

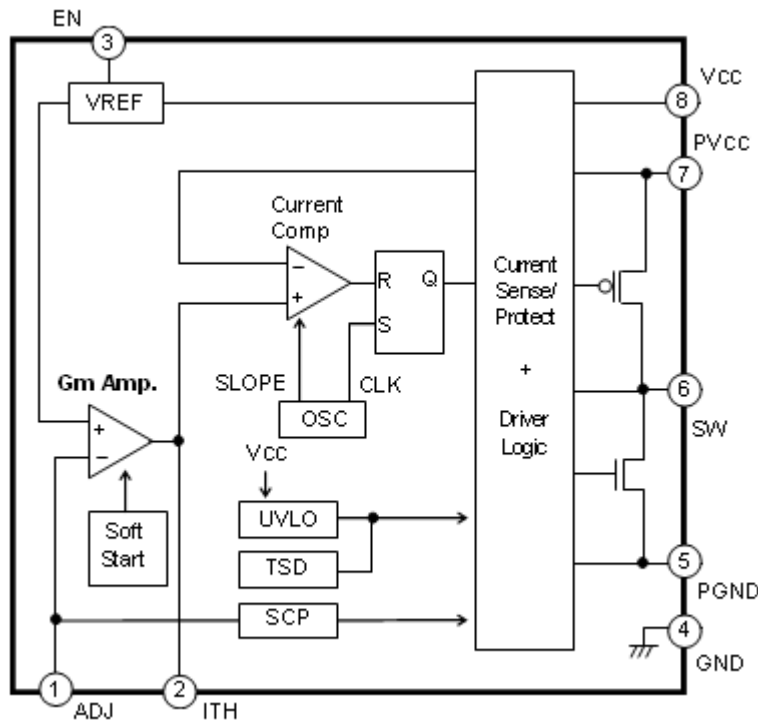

Fig.9 BD9120HFN Block Diagram

● Typical Performance Curves

[BD9106FVM]

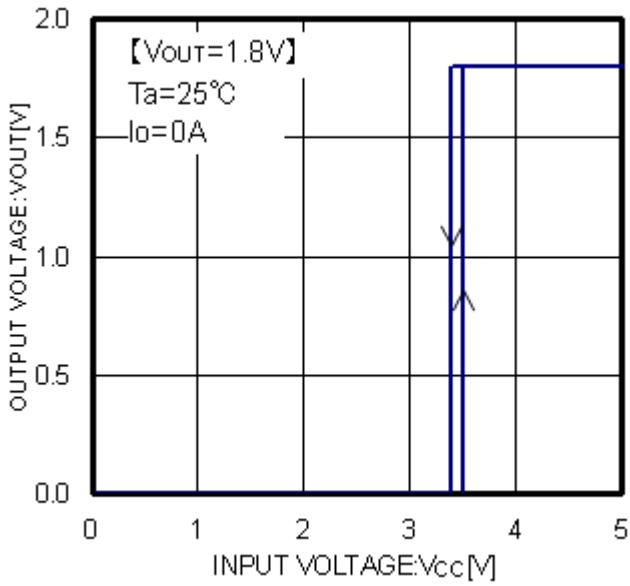

Fig.10 Vcc-Vout

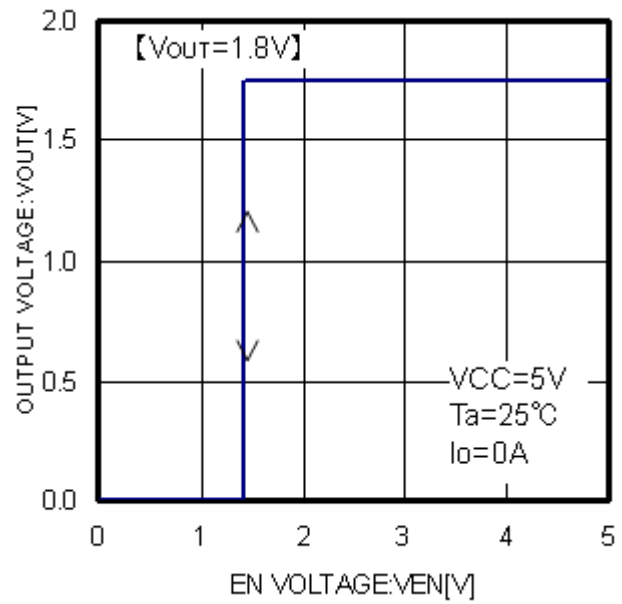

Fig.11 Ven-Vout

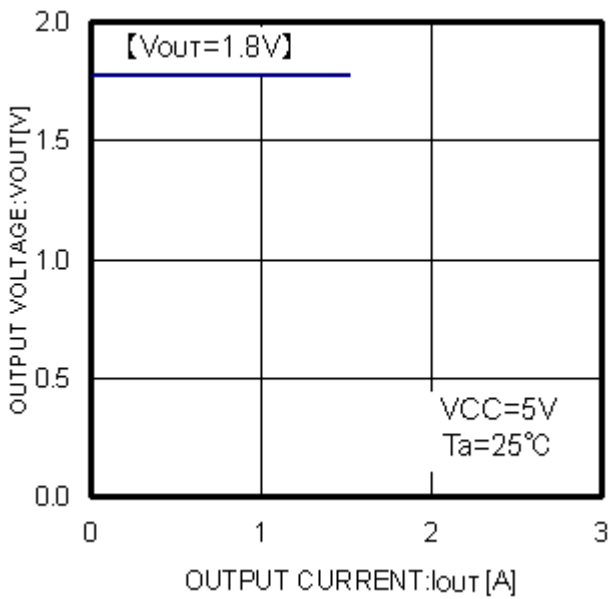

Fig.12 Iout-Vout

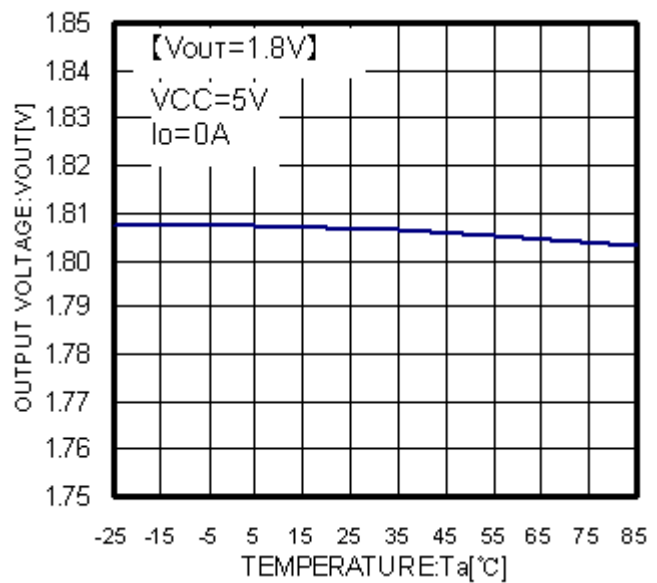

Fig.13 Ta-Vout

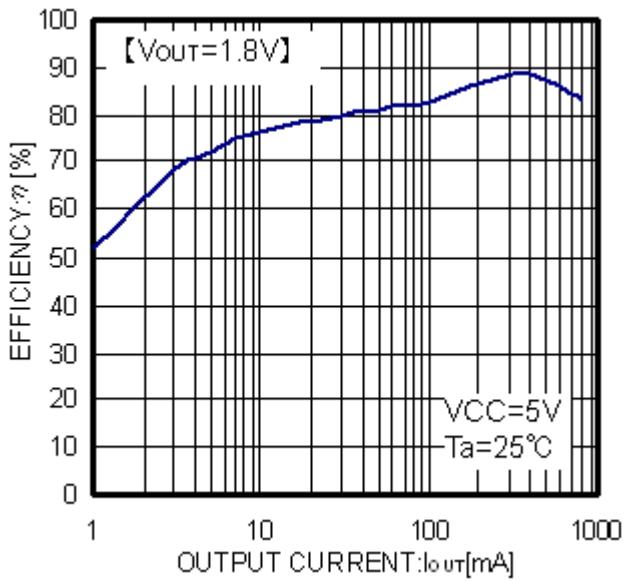

Fig.14 Efficiency

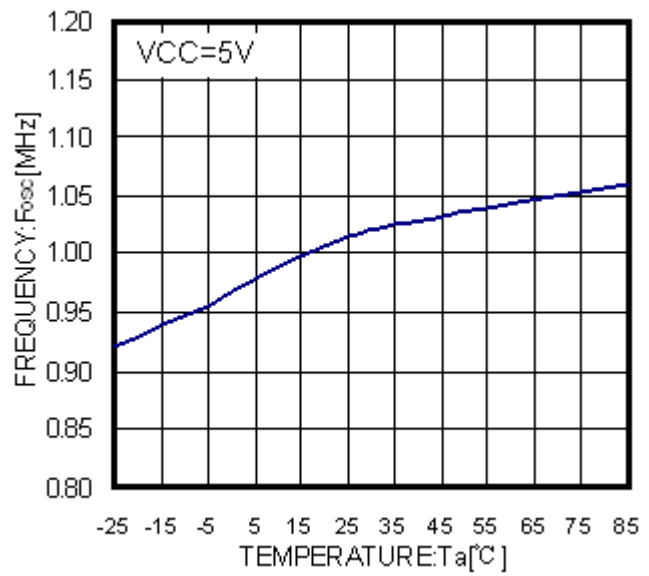

Fig.15 T_a - F_{osc}

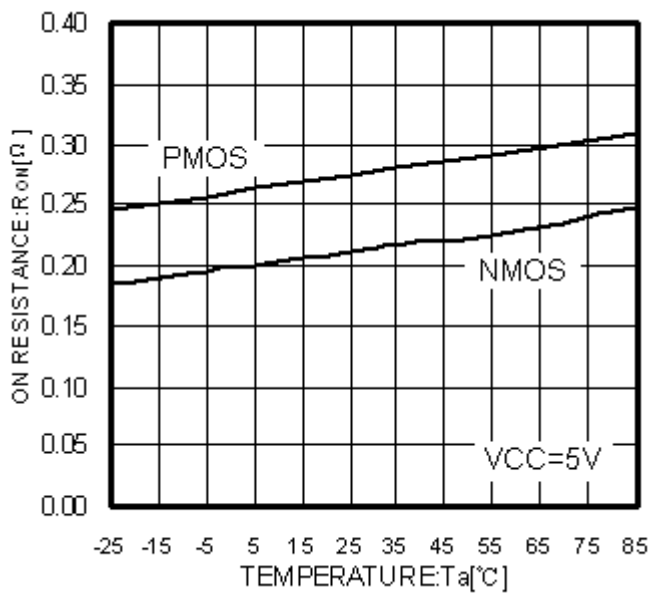

Fig.16 T_a - R_{onp} , R_{onp}

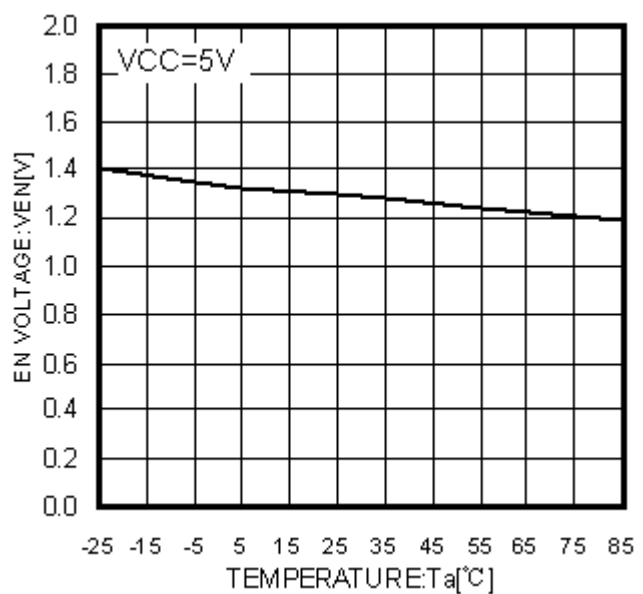

Fig.17 T_a - V_{en}

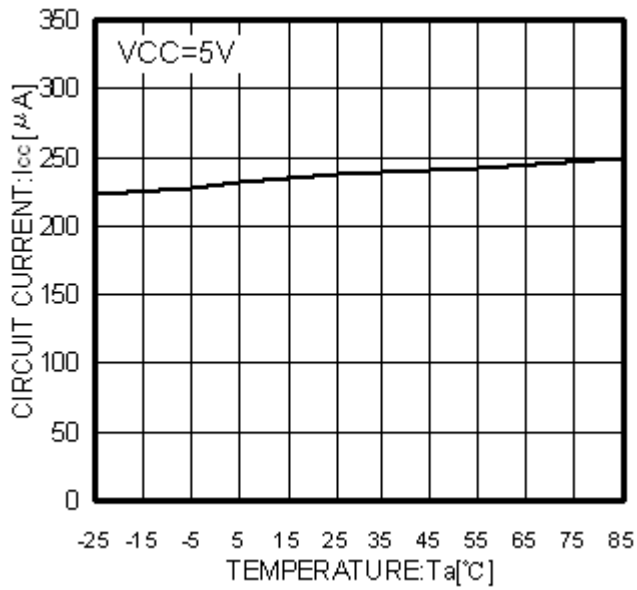

Fig.18 T_a - I_{cc}

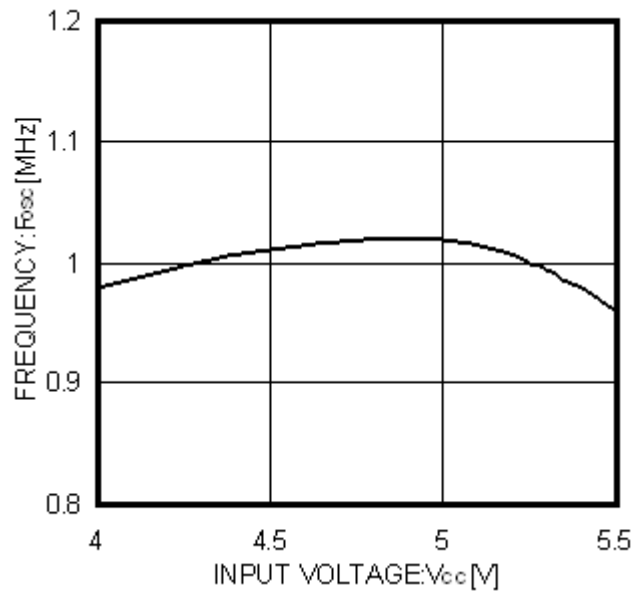

Fig.19 V_{cc} - F_{osc}

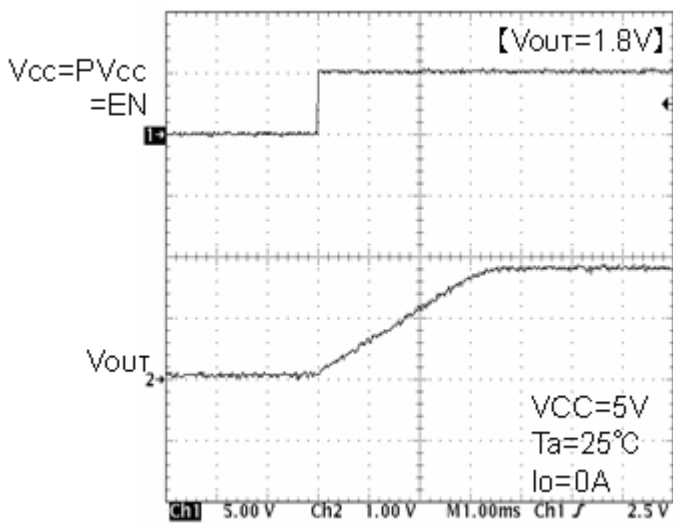

Fig.20 Soft start waveform

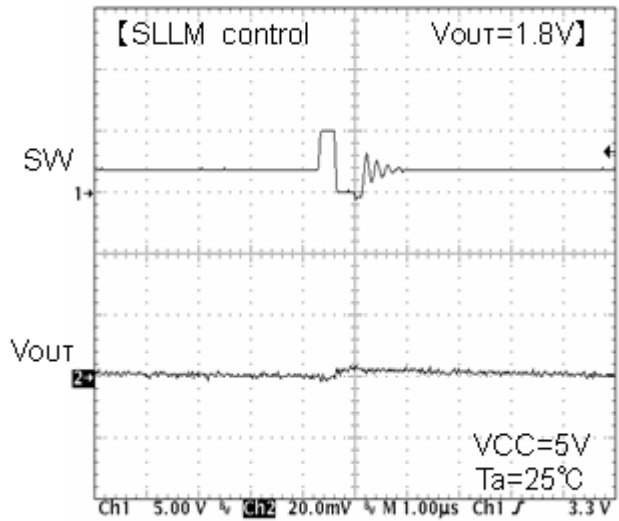

Fig.21 SW waveform $I_o=10mA$

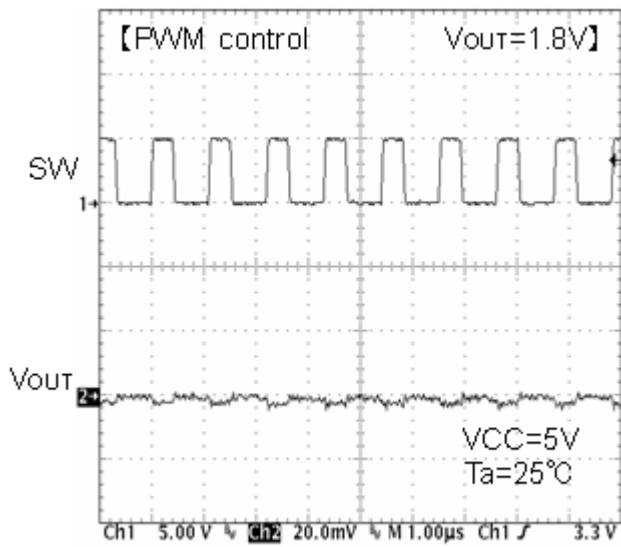

Fig.22 SW waveform $I_o=200\text{mA}$

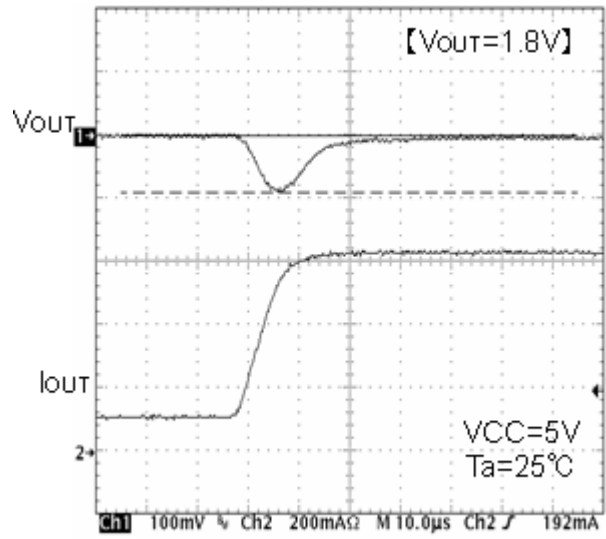

Fig. 23 Transient response
 $I_o=100\rightarrow 600\text{mA}(10\mu\text{s})$

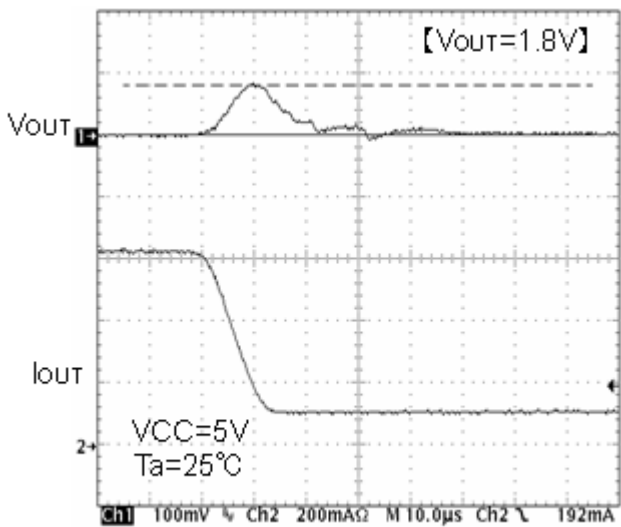

Fig.24 Transient response
 $I_o=600\rightarrow 100\text{mA}(10\mu\text{s})$

【BD9107FVM】

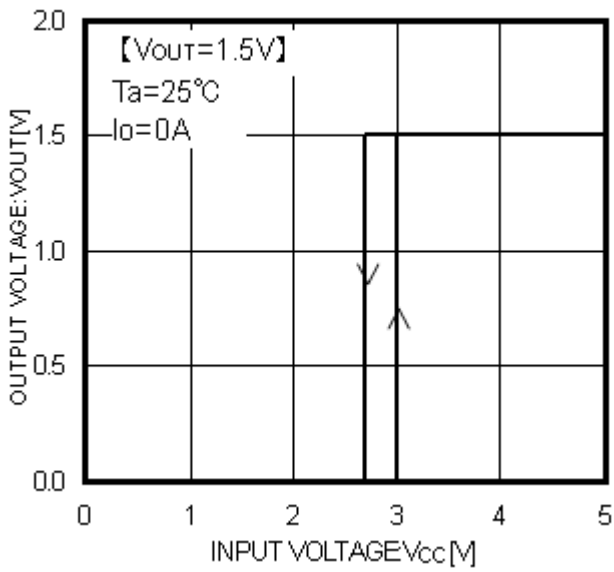

Fig.25 Vcc-Vout

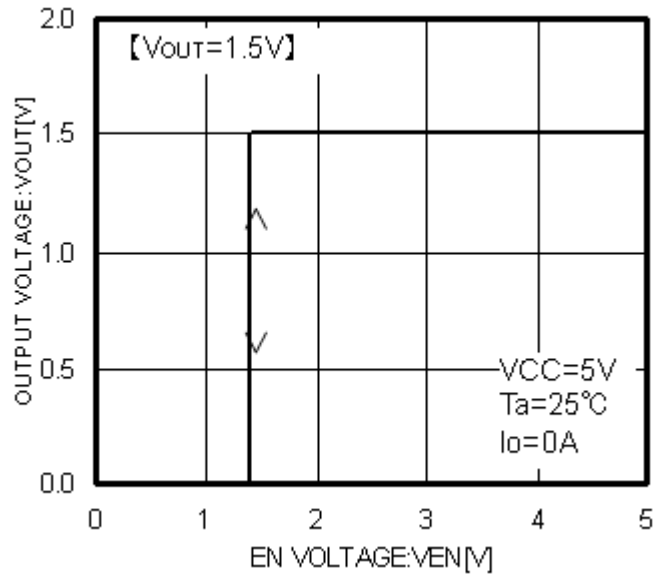

Fig.26 Ven-Vout

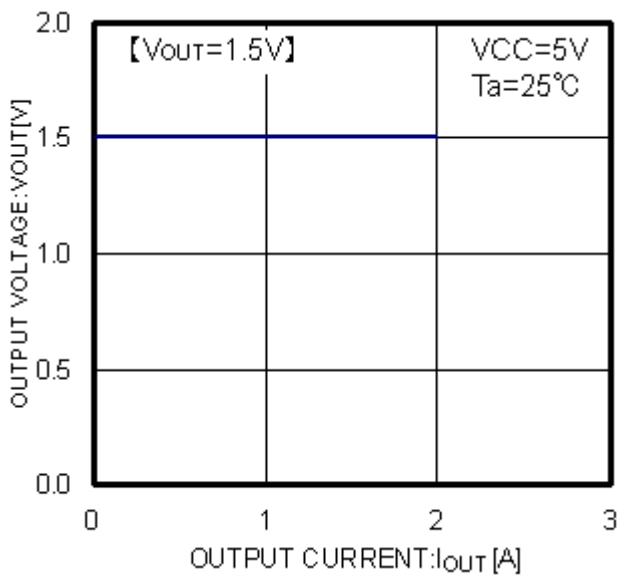

Fig.27 Iout-Vout

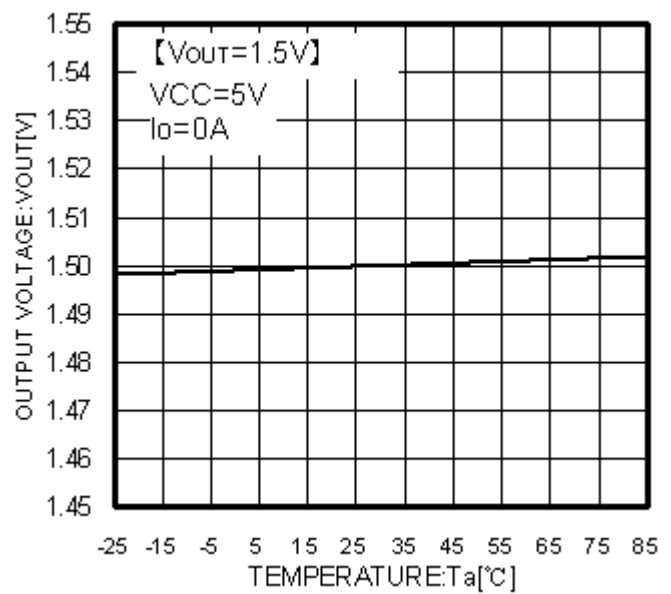

Fig.28 T_a-Vout

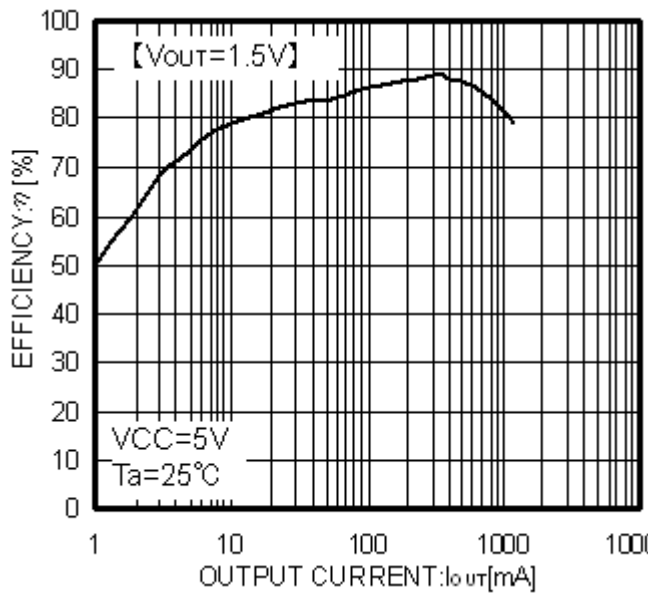

Fig.29 Efficiency

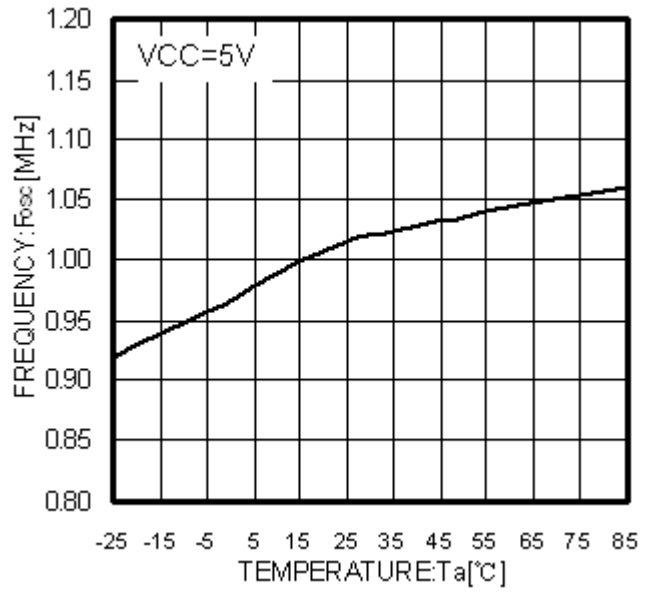

Fig.30 T_a - F_{osc}

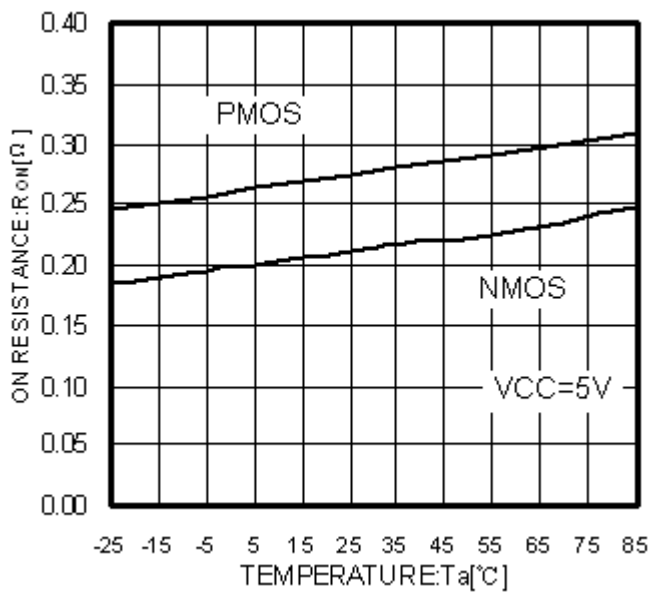

Fig.31 T_a - R_{ONN} , R_{ONP}

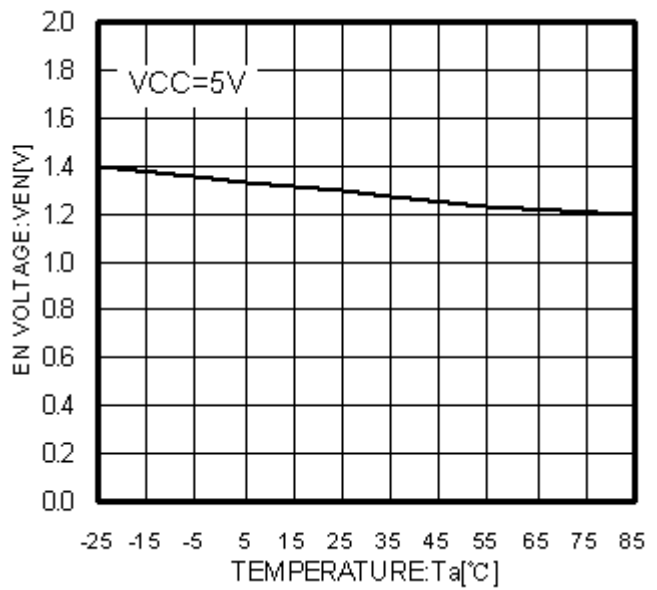

Fig.32 T_a - V_{EN}

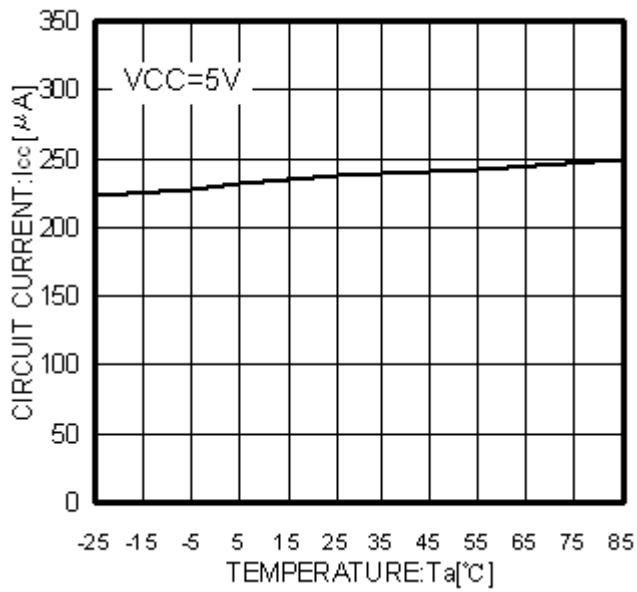

Fig.33 Ta-Icc

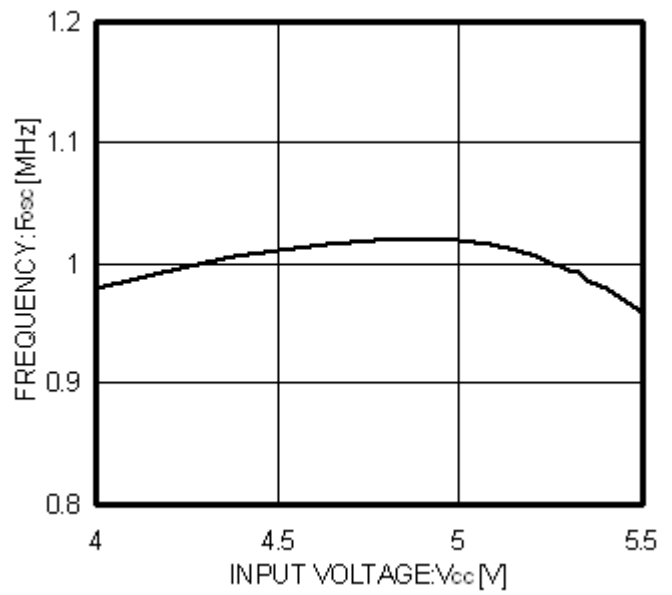

Fig.34 Vcc-Fosc

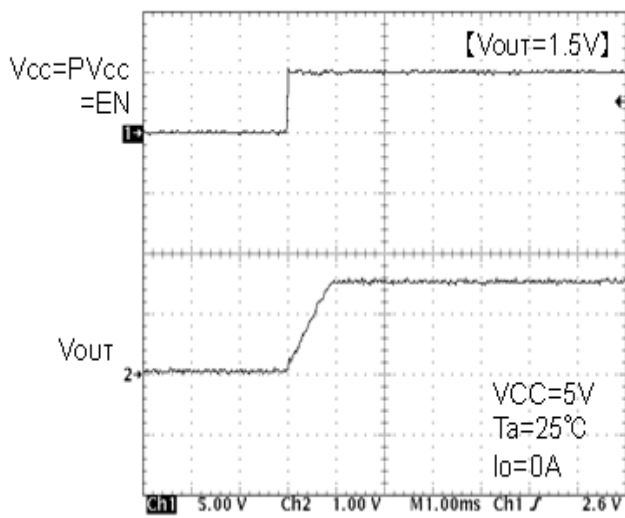

Fig.35 Soft start waveform

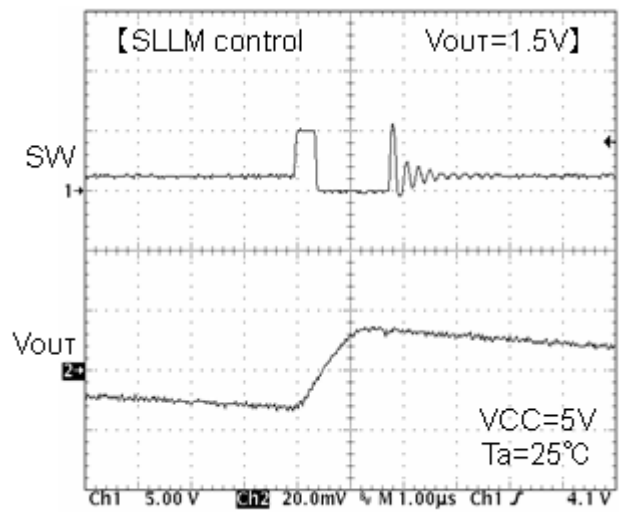

Fig.36 SW waveform Io=10mA

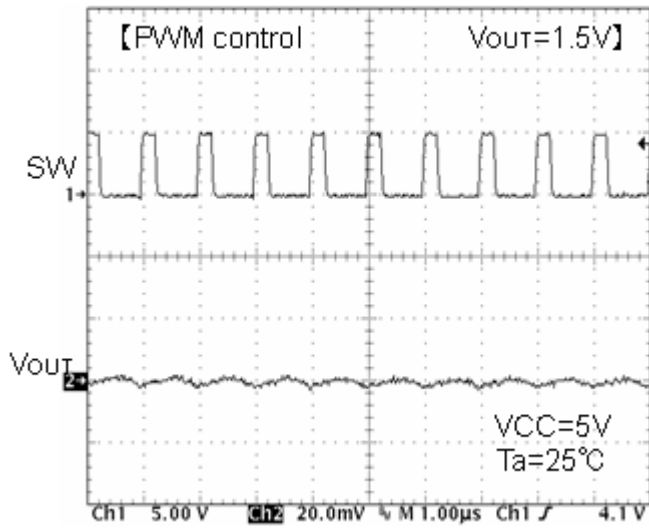

Fig.37 SW waveform $I_o=500\text{mA}$

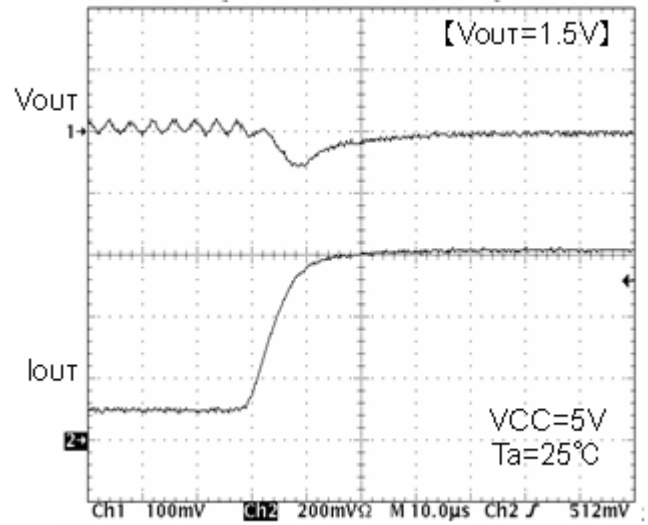

Fig. 38 Transient response
 $I_o=100\rightarrow 600\text{mA}(10\mu\text{s})$

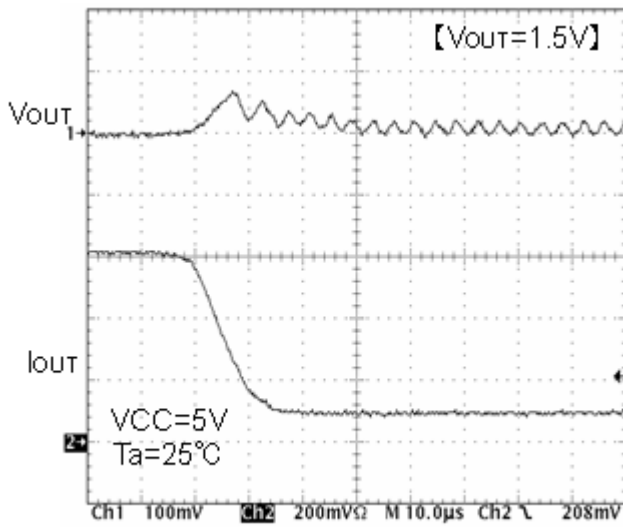

Fig.39 Transient response
 $I_o=600\rightarrow 100\text{mA}(10\mu\text{s})$

【BD9109FVM】

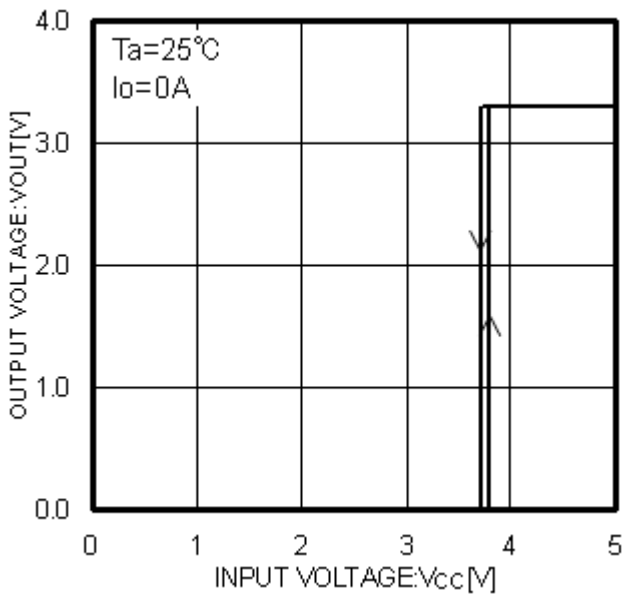

Fig.40 Vcc-Vout

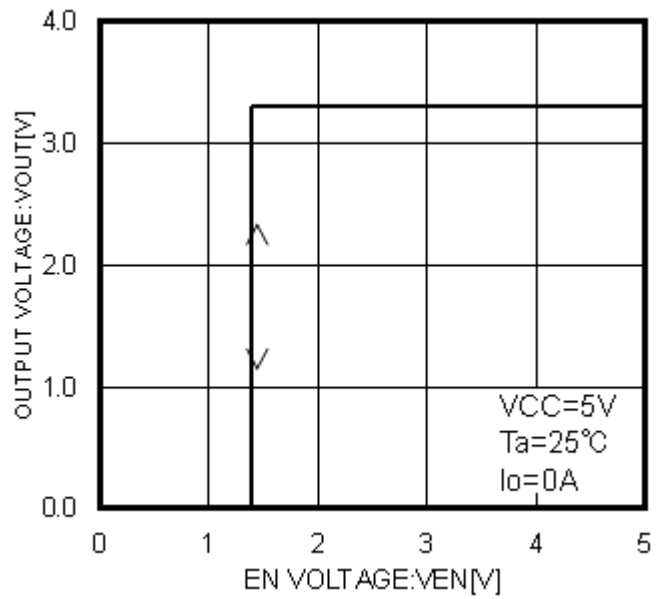

Fig.41 Ven-Vout

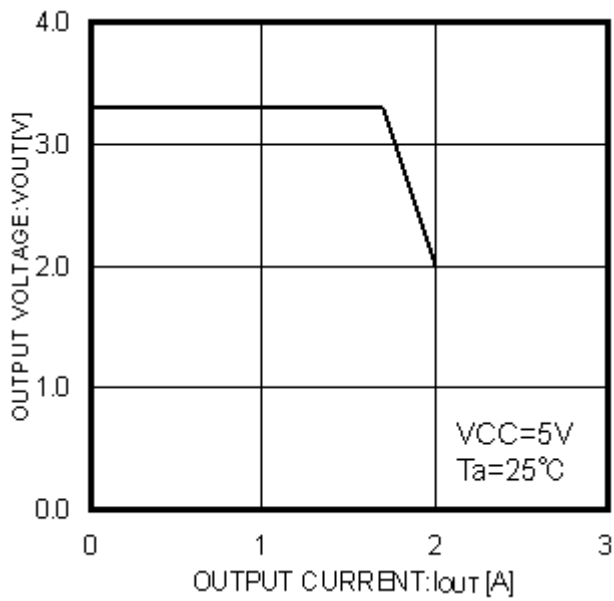

Fig.42 Iout-Vout

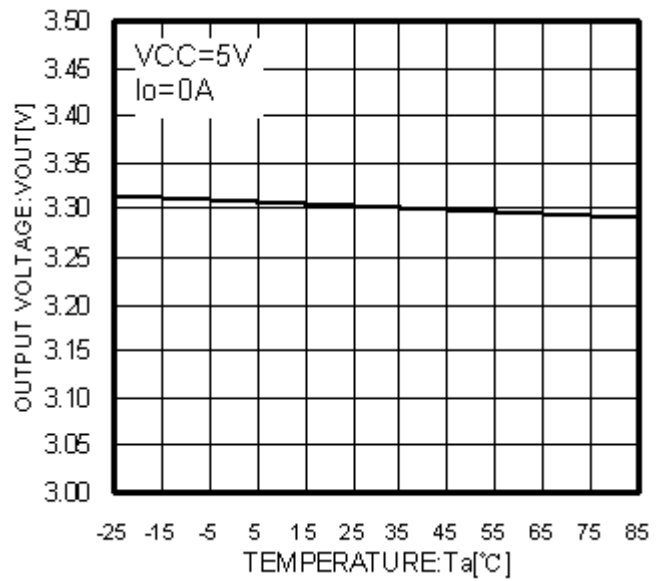

Fig. 43 Ta-Vout

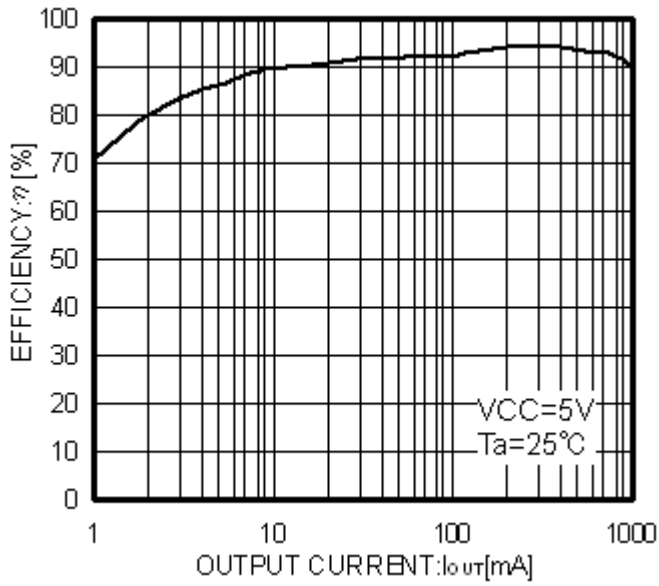

Fig.44 Efficiency

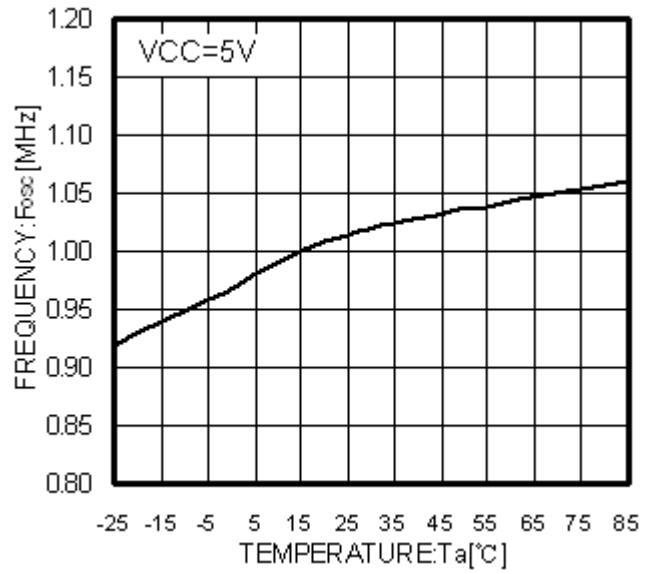

Fig.45 Ta-Fosc

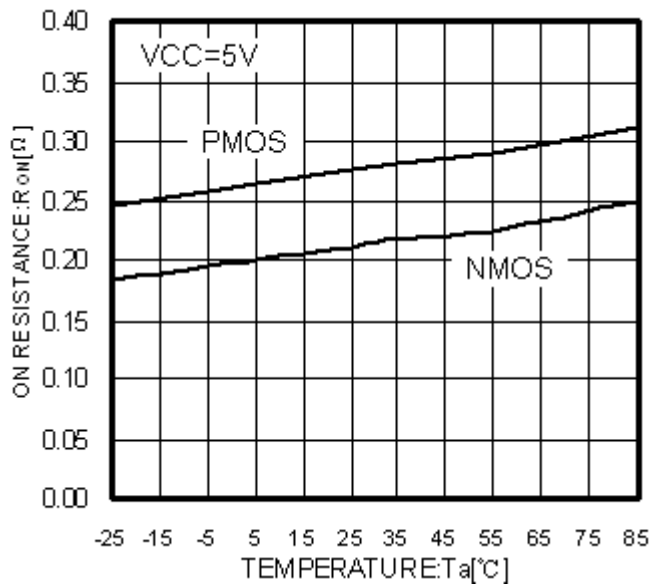

Fig.46 Ta-Ron, Ronp

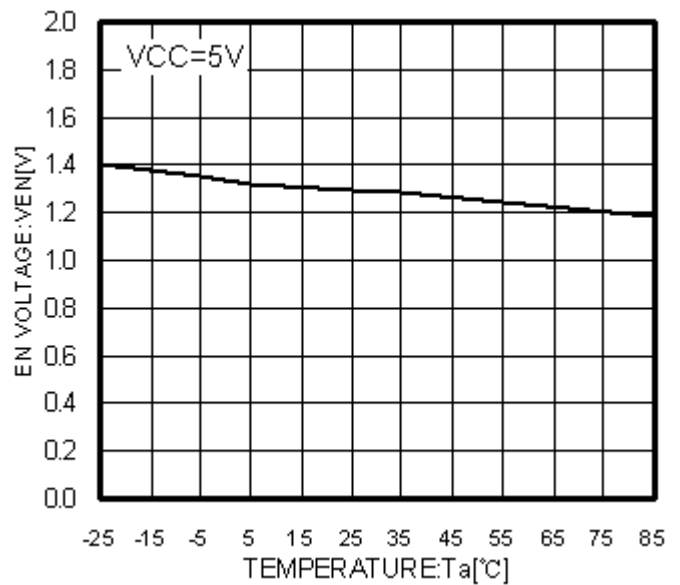

Fig.47 Ta-Ven

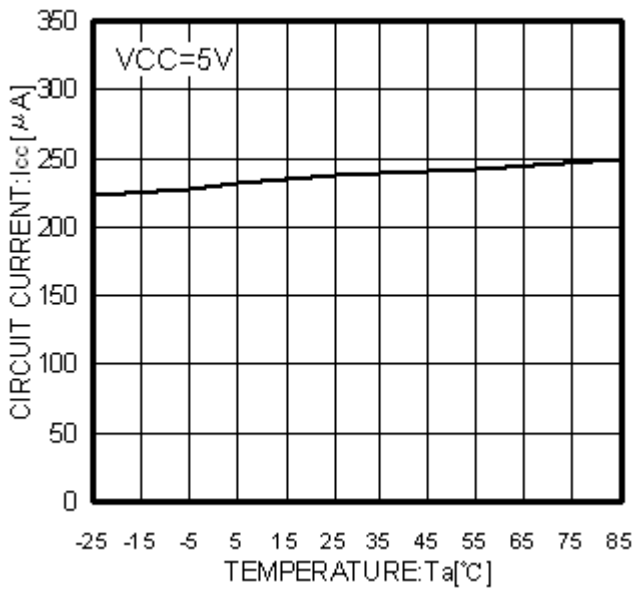

Fig.48 Ta-I_{cc}

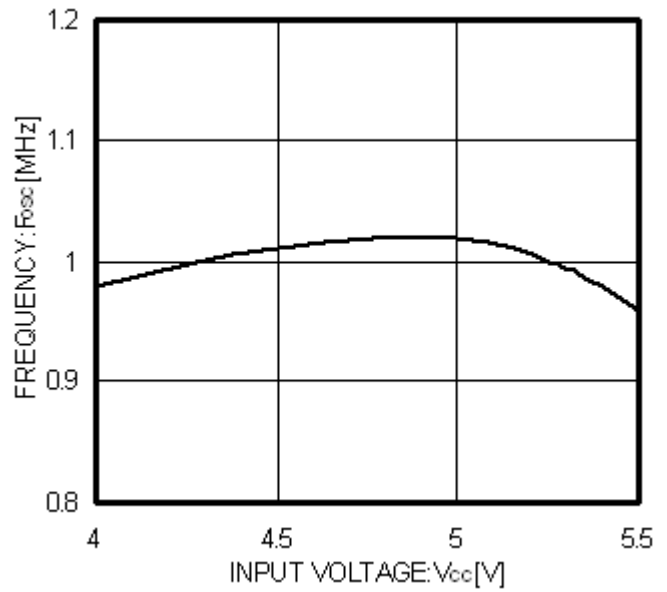

Fig.49 V_{cc}-F_{osc}

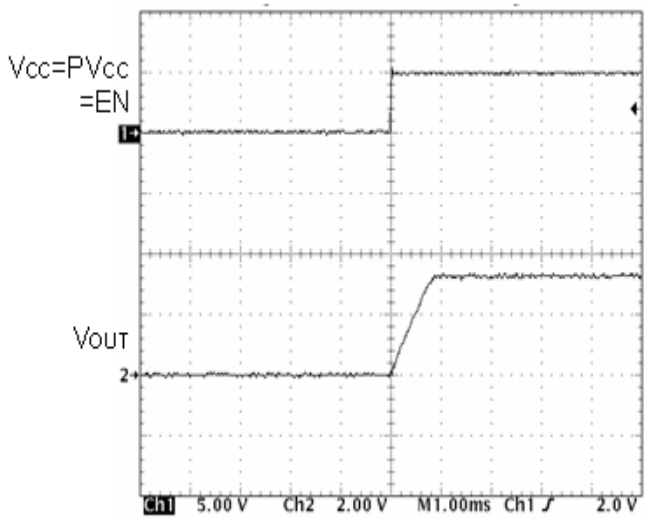

Fig.50 Soft start waveform

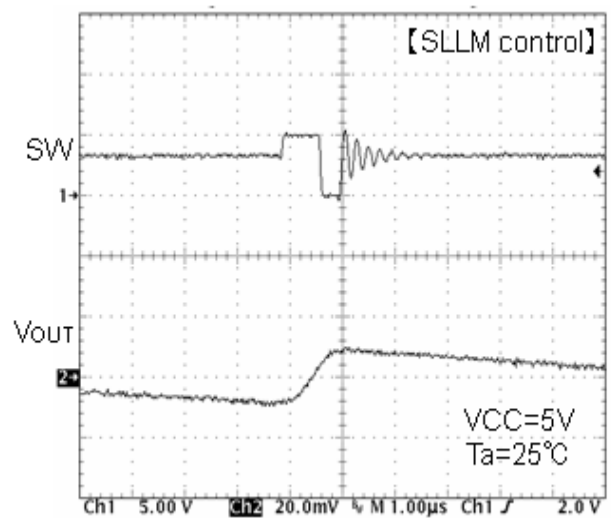

Fig.51 SW waveform I_o=10mA

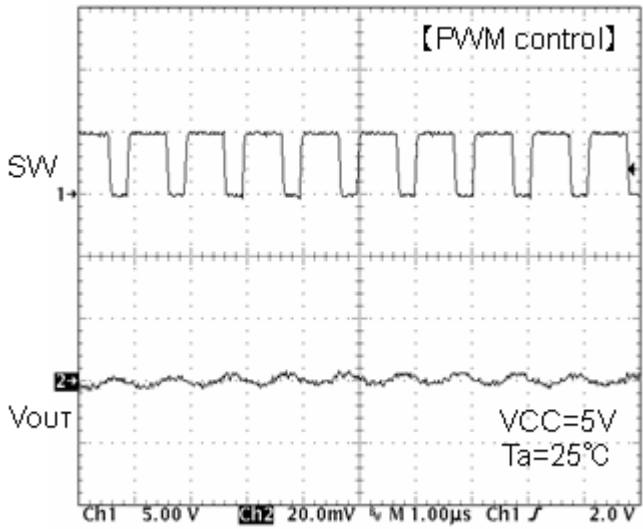

Fig.52 SW waveform $I_o=500\text{mA}$

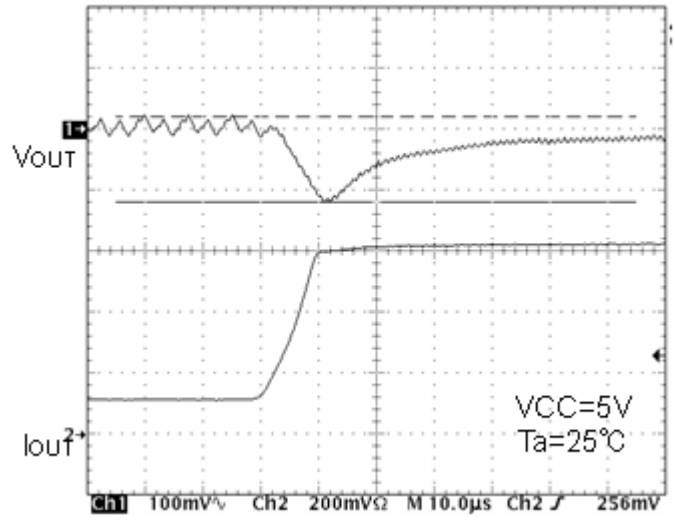

Fig. 53 Transient response
 $I_o=100\rightarrow 600\text{mA}(10\mu\text{s})$

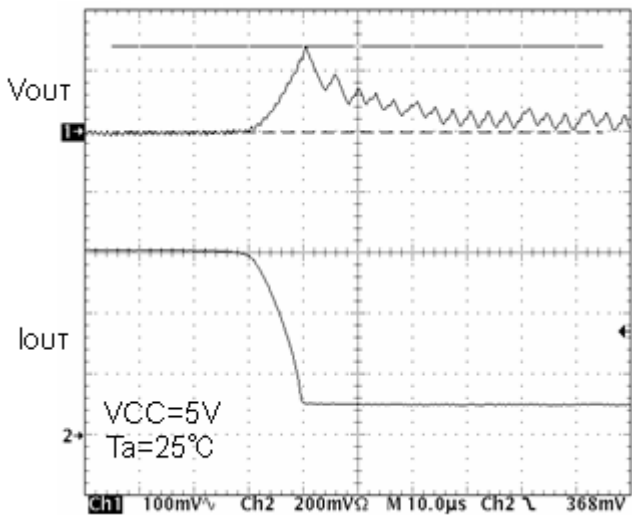

Fig.54 Transient response
 $I_o=600\rightarrow 100\text{mA}(10\mu\text{s})$

【BD9110NV】

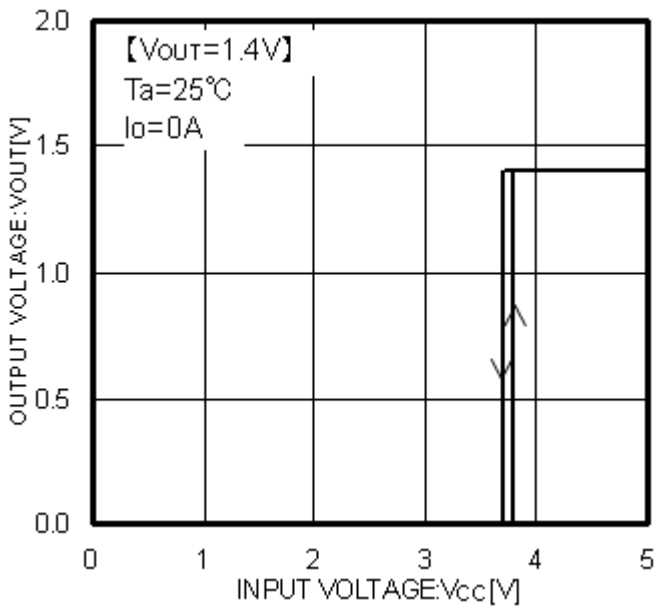

Fig.55 Vcc-Vout

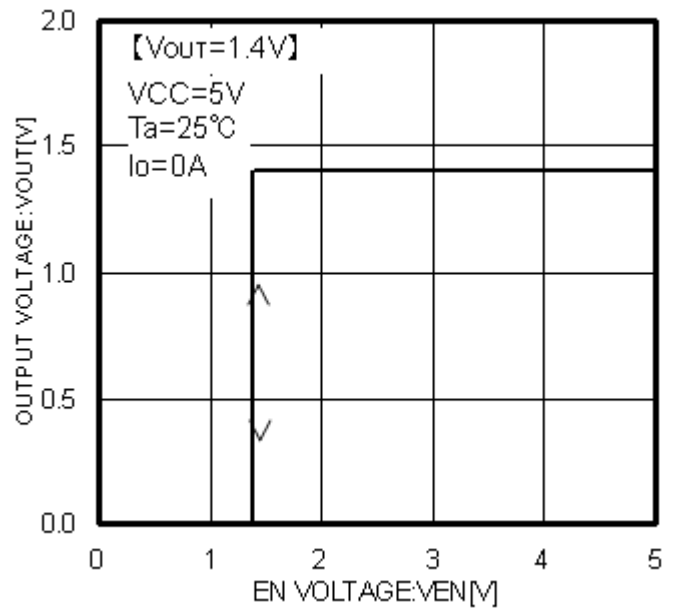

Fig.56 Ven-Vout

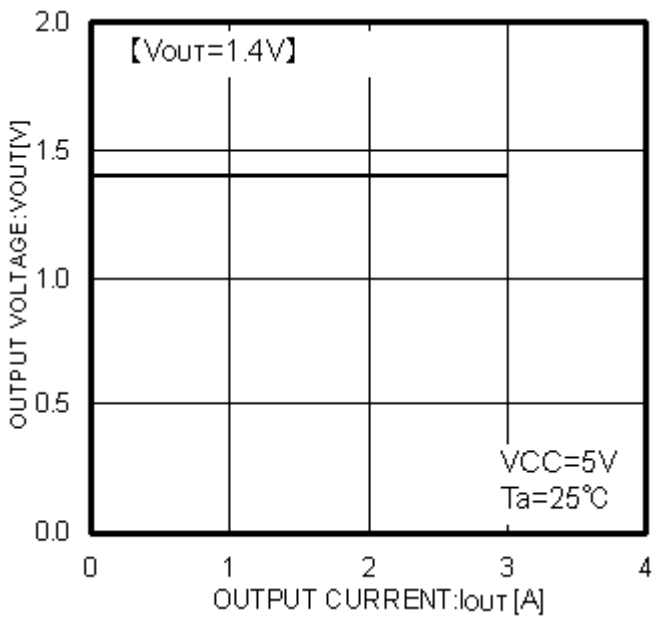

Fig.57 Iout-Vout

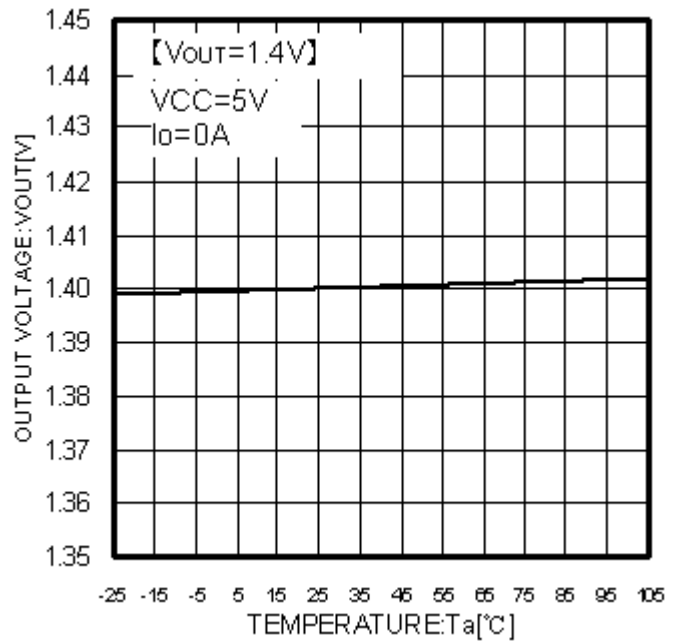

Fig. 58 Ta-Vout

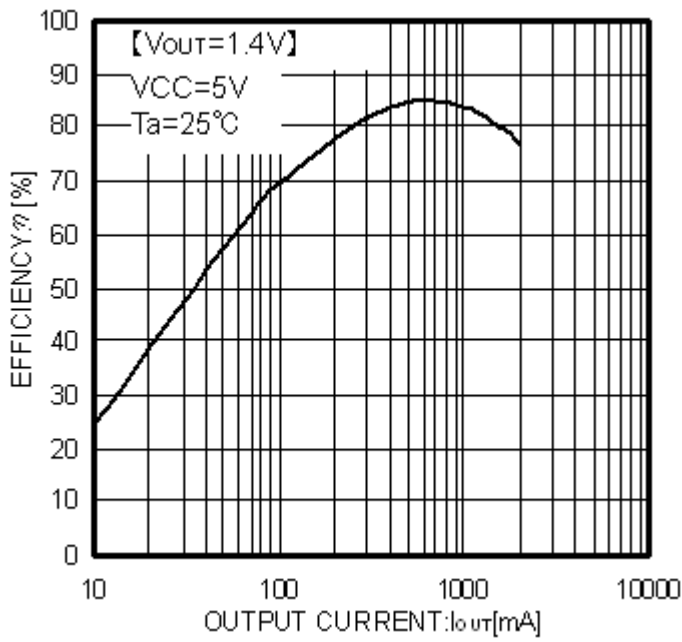

Fig.59 Efficiency

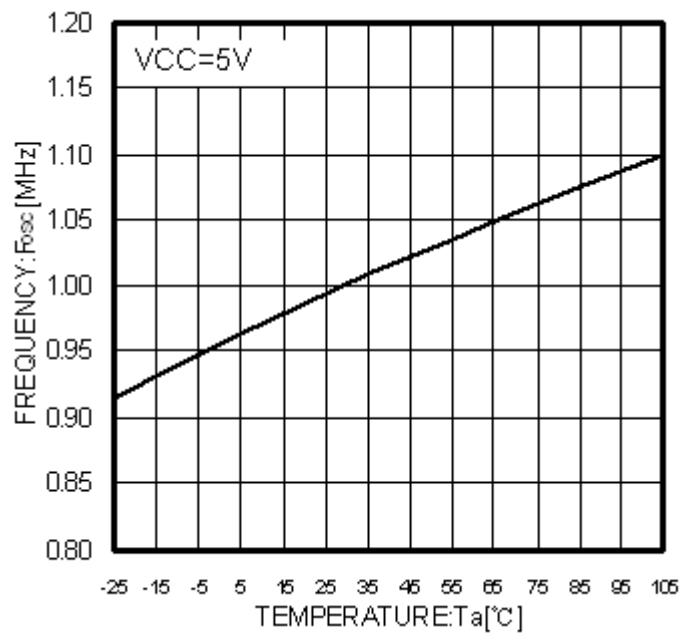

Fig.60 T_a - F_{osc}

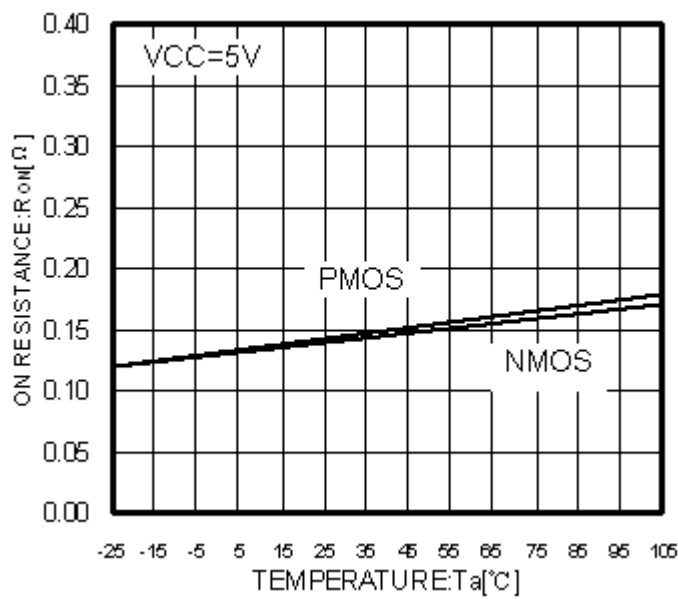

Fig.61 T_a - R_{on} , R_{onp}

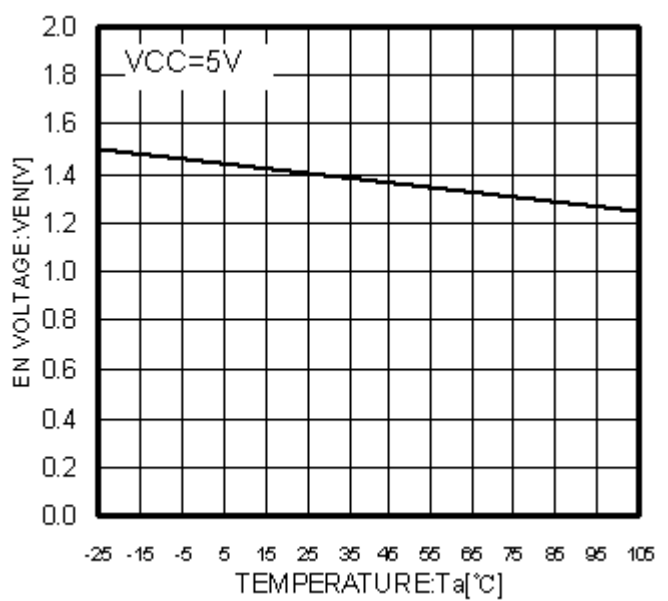

Fig.62 T_a - V_{en}

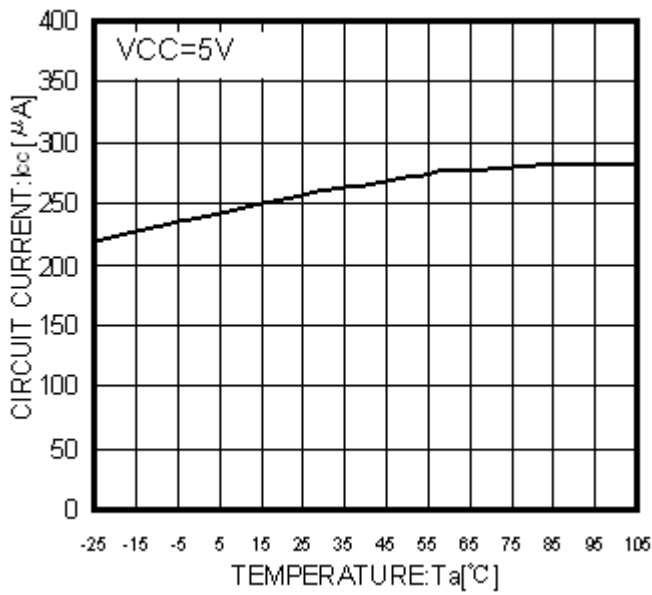

Fig.63 Ta-Icc

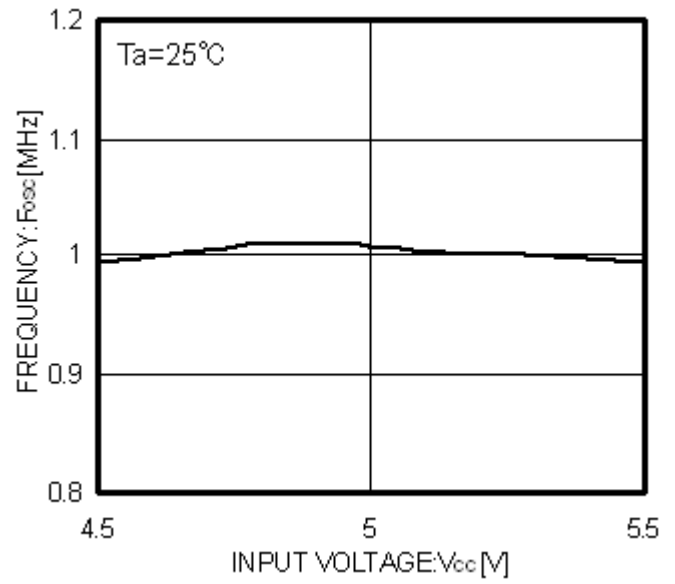

Fig.64 Vcc-Fosc

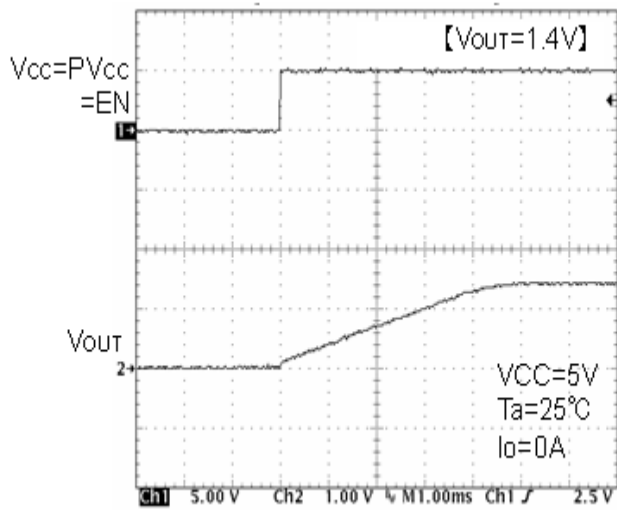

Fig.65 Soft start waveform

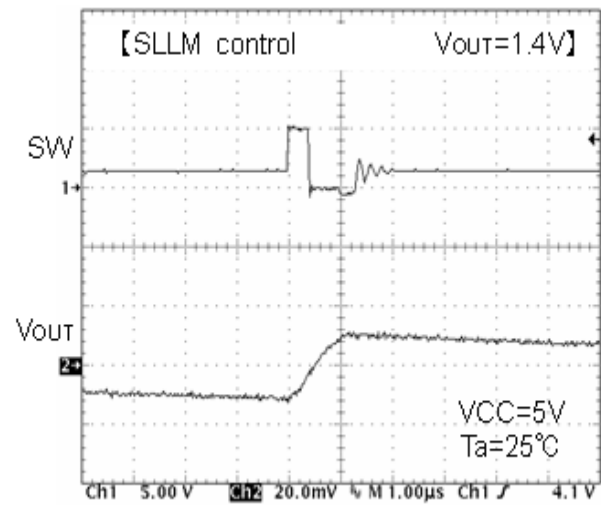

Fig.66 SW waveform Io=10mA

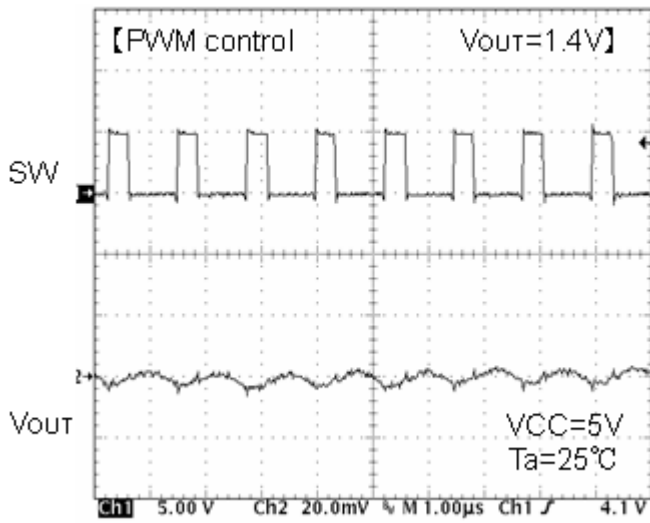

Fig.67 SW waveform Io=500mA

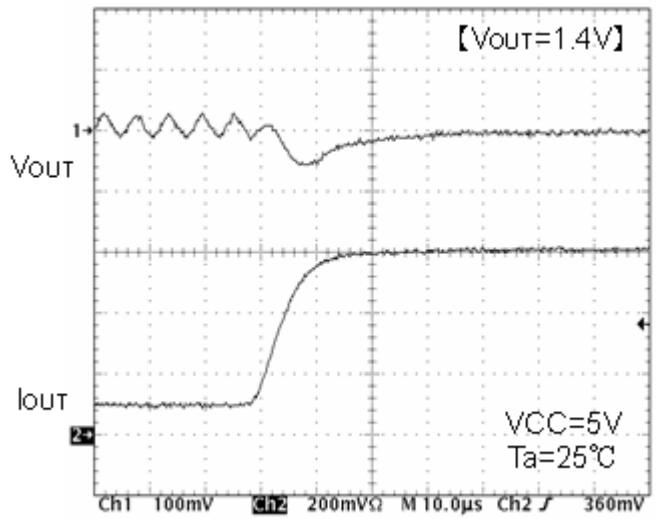

Fig. 68 Transient response
Io=100→600mA(10µs)

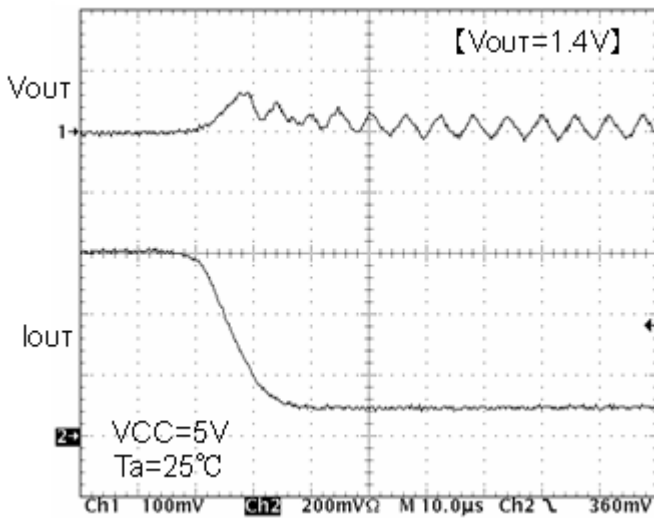

Fig.69 Transient response
Io=600→100mA(10µs)

【BD9120HFN】

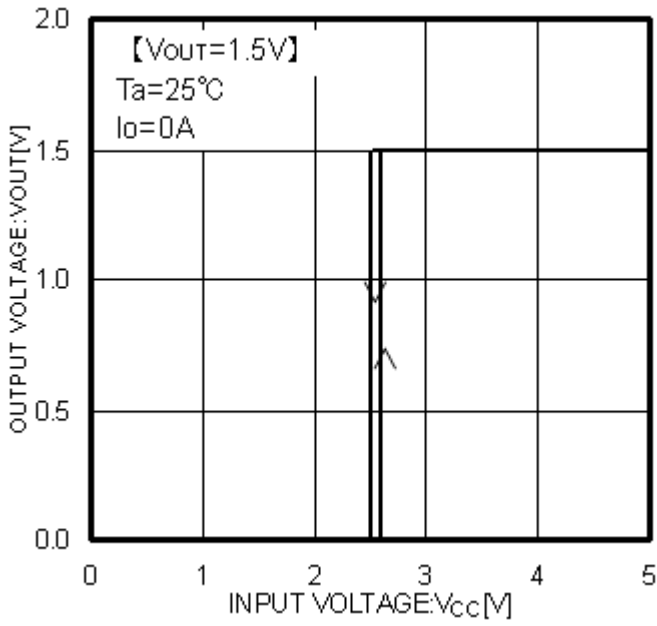

Fig.70 Vcc-Vout

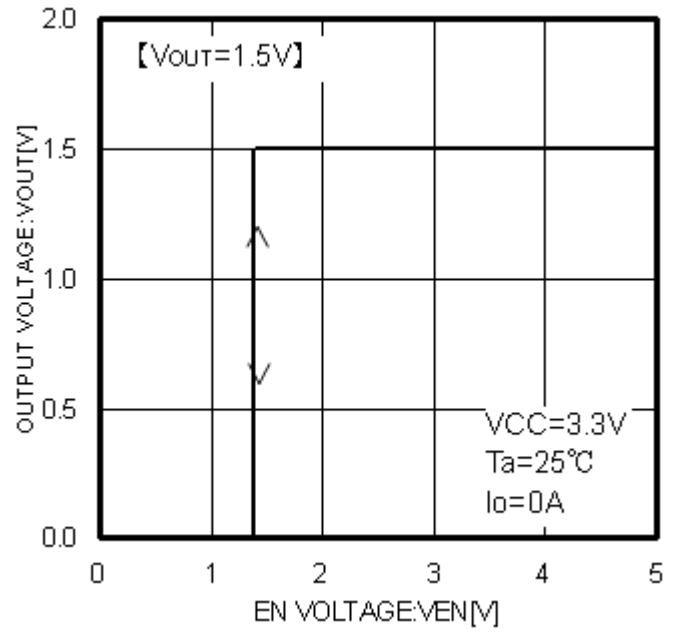

Fig.71 Ven-Vout

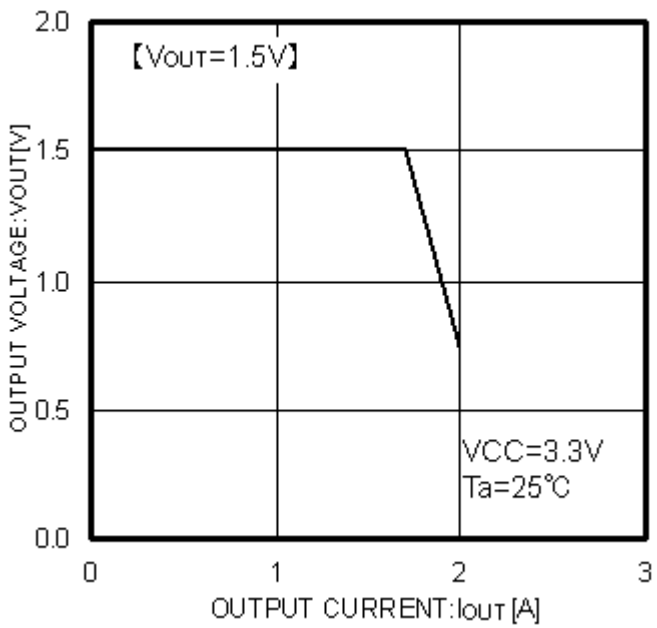

Fig.72 Iout-Vout

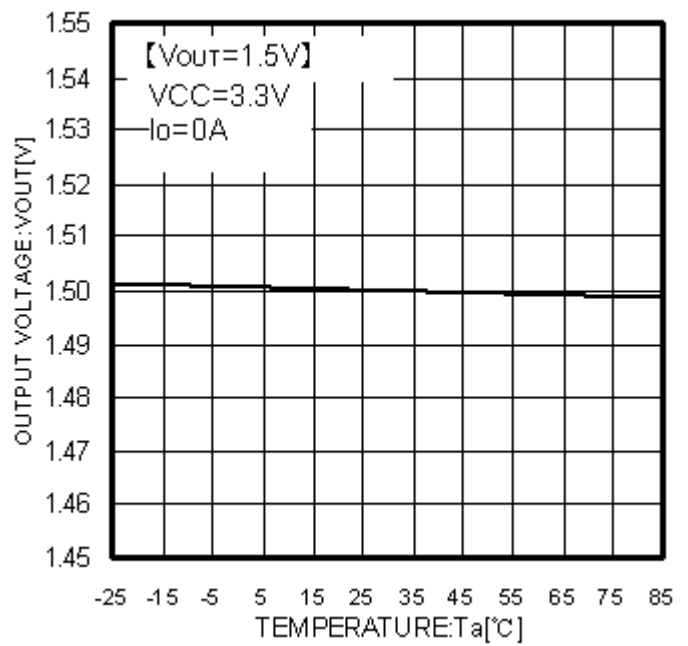

Fig. 73 T_a-Vout

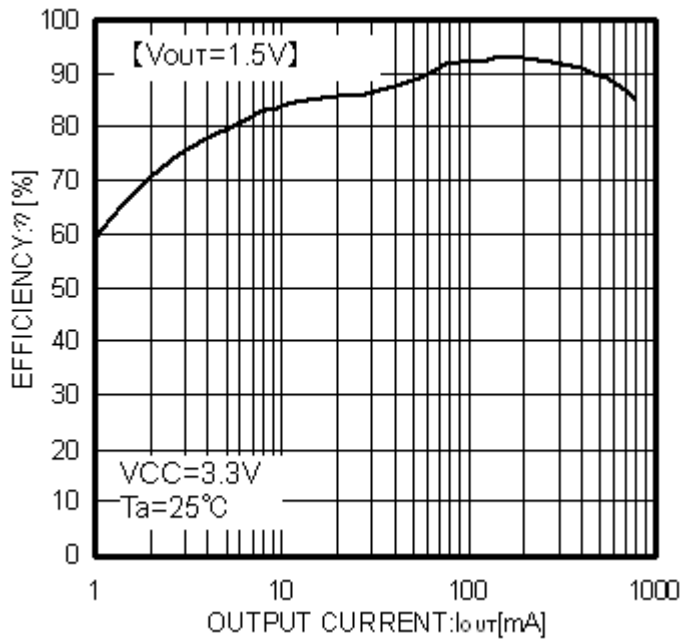

Fig.74 Efficiency

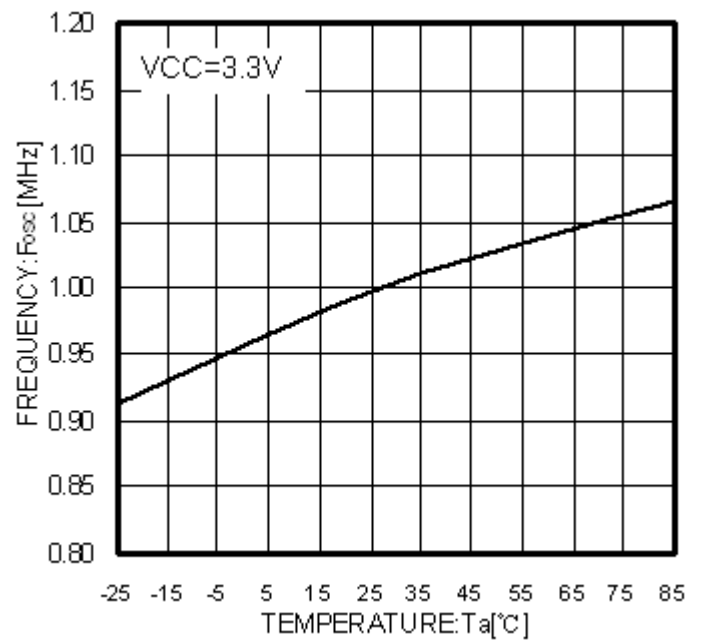

Fig.75 T_a - F_{osc}

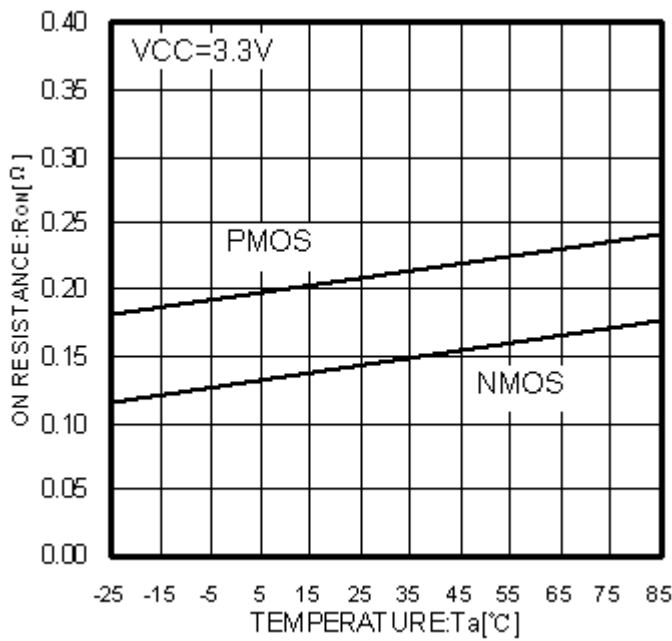

Fig.76 T_a - R_{onn} , R_{onp}

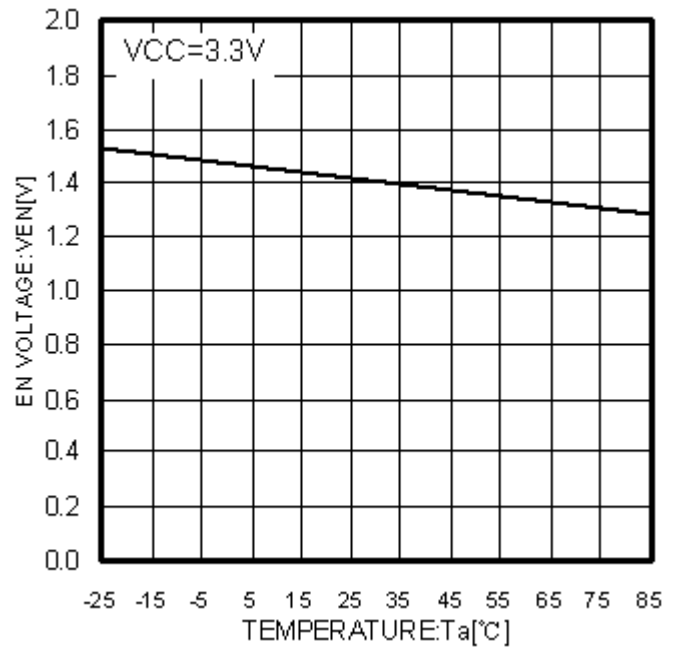

Fig.77 T_a - V_{en}

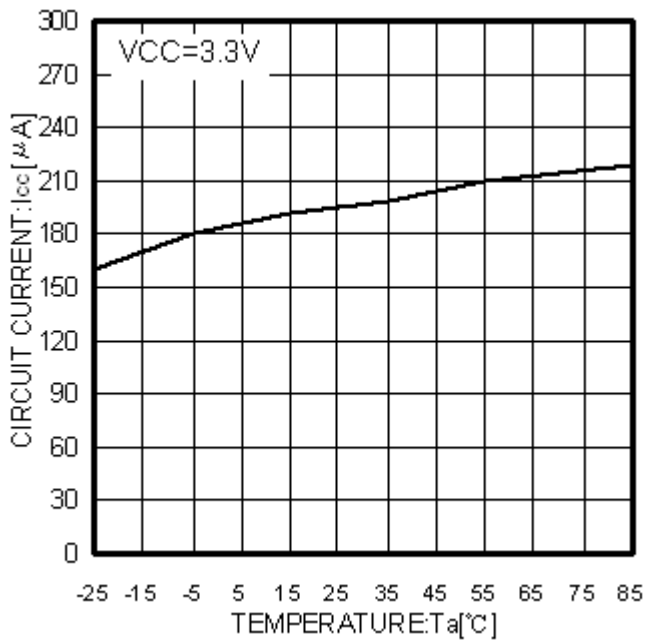

Fig.78 T_a - I_{cc}

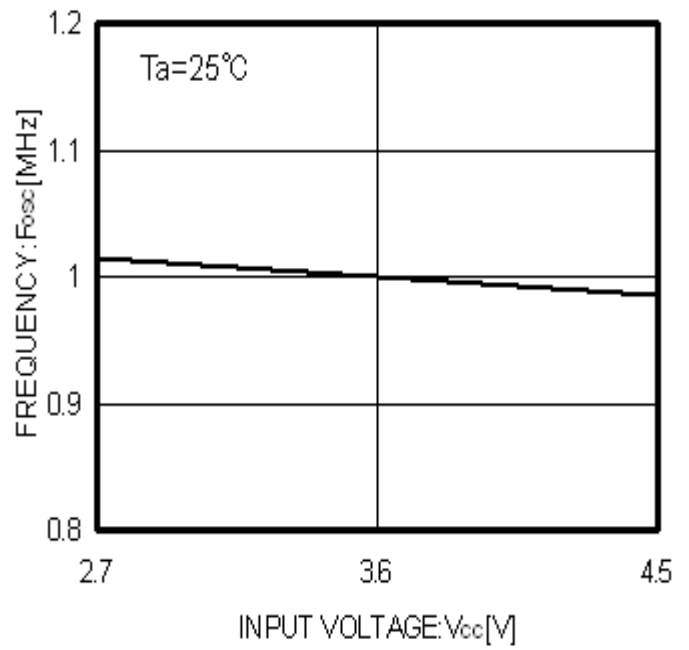

Fig.79 V_{cc} - F_{osc}

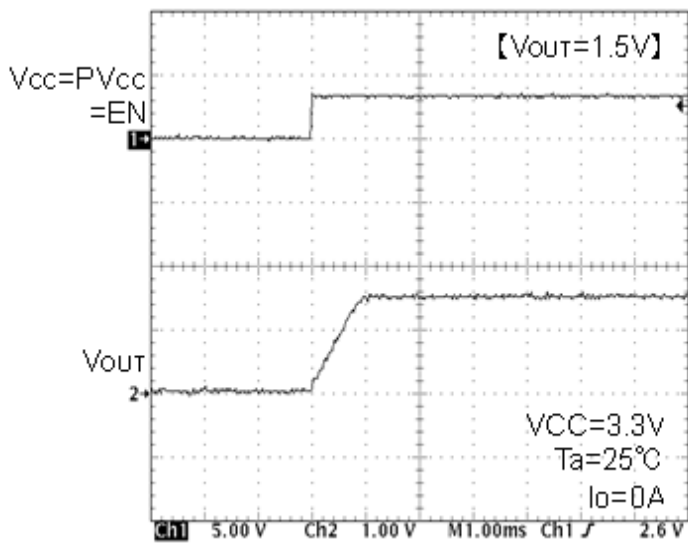

Fig.80 Soft start waveform

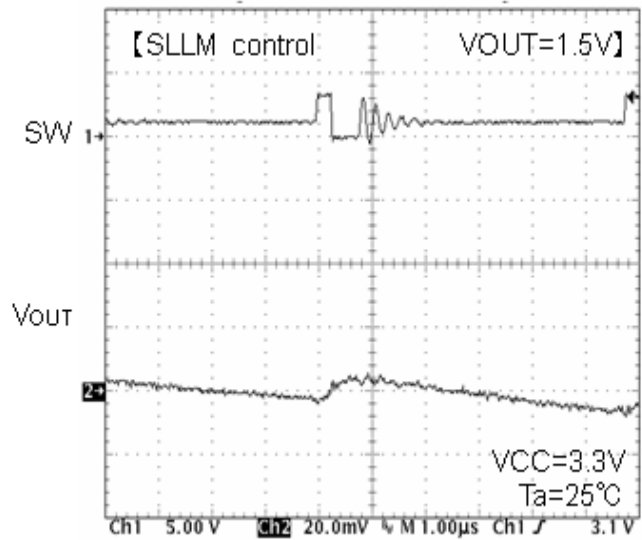

Fig.81 SW waveform $I_o=10mA$

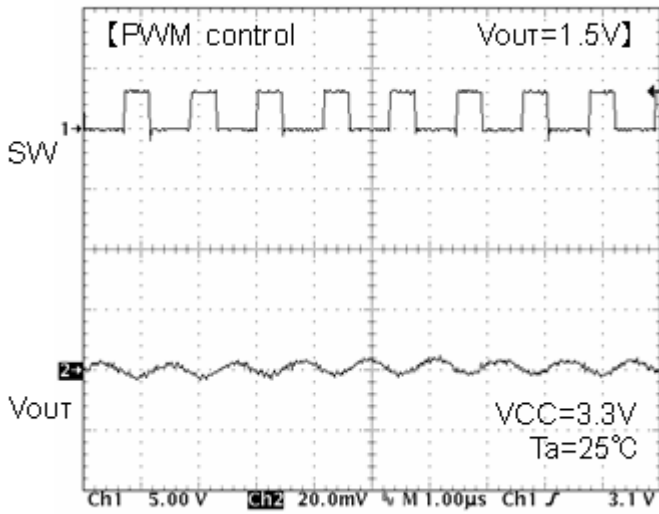

Fig.82 SW waveform $I_o=200\text{mA}$

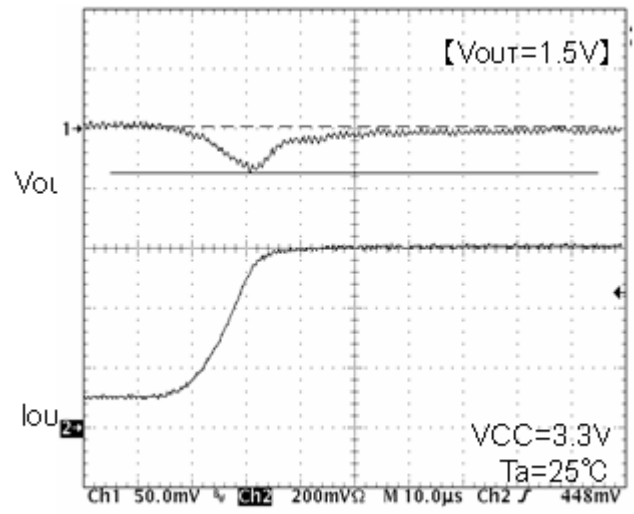

Fig. 83 Transient response
 $I_o=100\rightarrow 600\text{mA}(10\mu\text{s})$

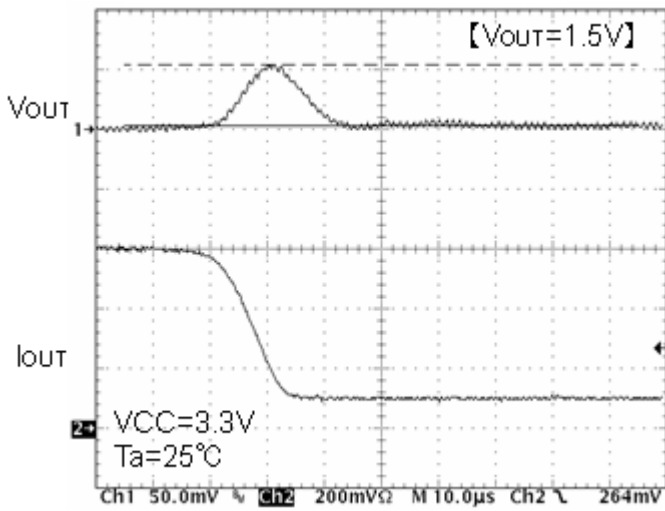

Fig.84 Transient response
 $I_o=600\rightarrow 100\text{mA}(10\mu\text{s})$

Application Information

●Operation

BD9106FVM, BD9107FVM, BD9109FVM, BD9110NV, BD9120HFN are a synchronous rectifying step-down switching regulator that achieves faster transient response by employing current mode PWM control system. It utilizes switching operation in PWM (Pulse Width Modulation) mode for heavier load, while it utilizes SLLM™ (Simple Light Load Mode) operation for lighter load to improve efficiency.

○Synchronous rectifier

It does not require the power to be dissipated by a rectifier externally connected to a conventional DC/DC converter IC, and its P.N junction shoot-through protection circuit limits the shoot-through current during operation, by which the power dissipation of the set is reduced.

○Current mode PWM control

Synthesizes a PWM control signal with a inductor current feedback loop added to the voltage feedback.

• PWM (Pulse Width Modulation) control

The oscillation frequency for PWM is 1 MHz. SET signal from OSC turns ON a P-channel MOS FET (while a N-channel MOS FET is turned OFF), and an inductor current I_L increases. The current comparator (Current Comp) receives two signals, a current feedback control signal (SENSE: Voltage converted from I_L) and a voltage feedback control signal (FB), and issues a RESET signal if both input signals are identical to each other, and turns OFF the P-channel MOS FET (while a N-channel MOS FET is turned ON) for the rest of the fixed period. The PWM control repeat this operation.

• SLLM™ (Simple Light Load Mode) control

When the control mode is shifted from PWM for heavier load to the one for lighter load or vice versa, the switching pulse is designed to turn OFF with the device held operated in normal PWM control loop, which allows linear operation without voltage drop or deterioration in transient response during the mode switching from light load to heavy load or vice versa.

Although the PWM control loop continues to operate with a SET signal from OSC and a RESET signal from Current Comp, it is so designed that the RESET signal is held issued if shifted to the light load mode, with which the switching is tuned OFF and the switching pulses are thinned out under control. Activating the switching intermittently reduces the switching dissipation and improves the efficiency.

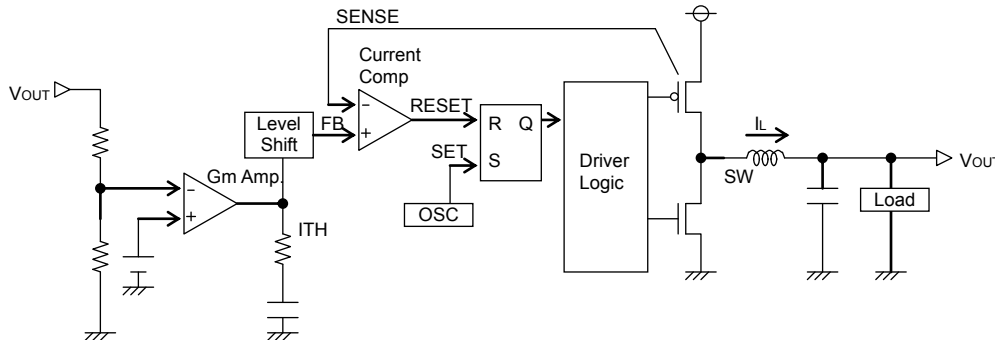

Fig.85 Diagram of current mode PWM control

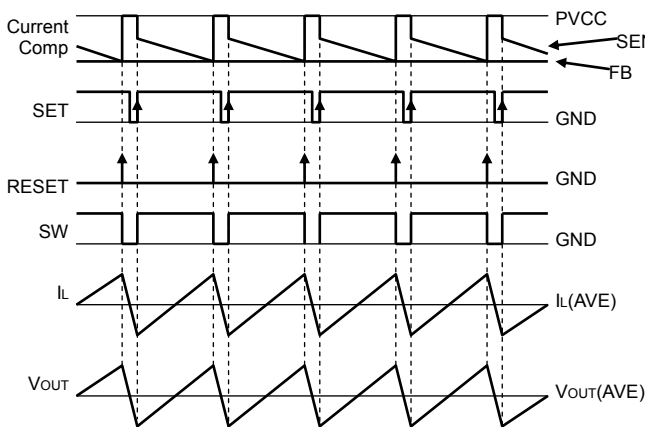

Fig.86 PWM switching timing chart

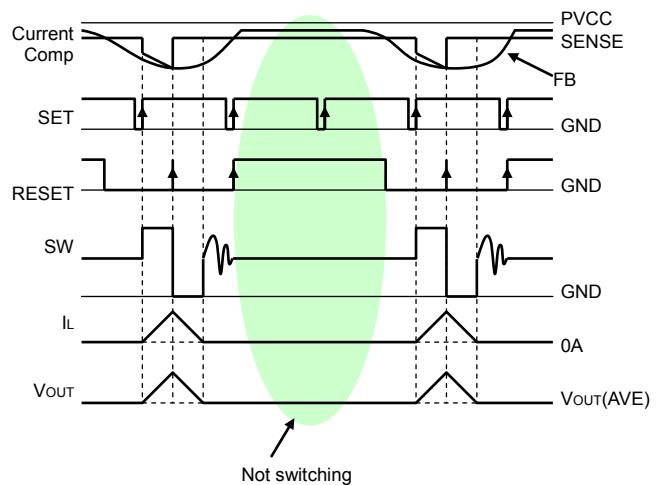

Fig.87 SLLM switching timing chart

●Description of Operations

- Soft-start function
EN terminal shifted to “High” activates a soft-starter to gradually establish the output voltage with the current limited during startup, by which it is possible to prevent an overshoot of output voltage and an inrush current.
- Shutdown function
With EN terminal shifted to “Low”, the device turns to Standby Mode, and all the function blocks including reference voltage circuit, internal oscillator and drivers are turned to OFF. Circuit current during standby is 0 μA (Typ.).
- UVLO function
Detects whether the input voltage sufficient to secure the output voltage of this IC is supplied. And the hysteresis width of 50 to 300 mV (Typ.) is provided to prevent output chattering.

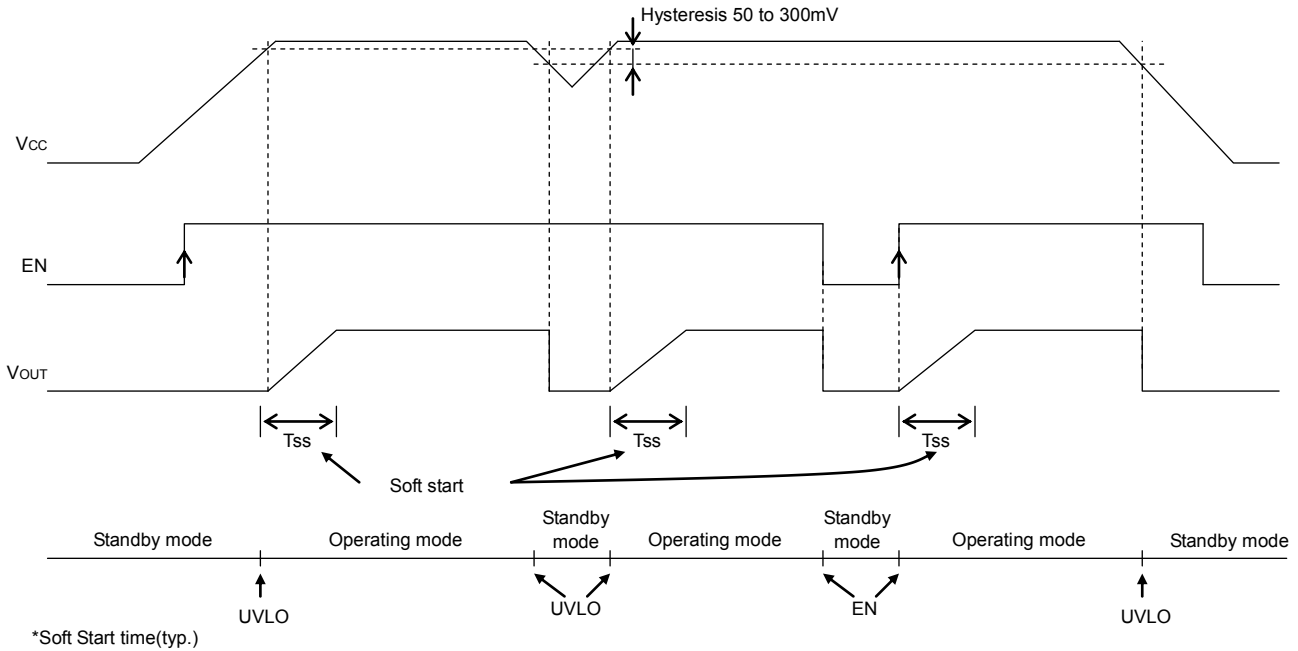

Fig.88 Soft start, Shutdown, UVLO timing chart

	BD9106FVM	BD9107FVM	BD9109FVM	BD9110NV	BD9120HFN	Unit
T _{ss}	3	1	1	5	1	msec

- Short-current protection circuit with time delay function
Turns OFF the output to protect the IC from breakdown when the incorporated current limiter is activated continuously for the fixed time(T_{LATCH}) or more. The output thus held turned OFF may be recovered by restarting EN or by re-unlocking UVLO.

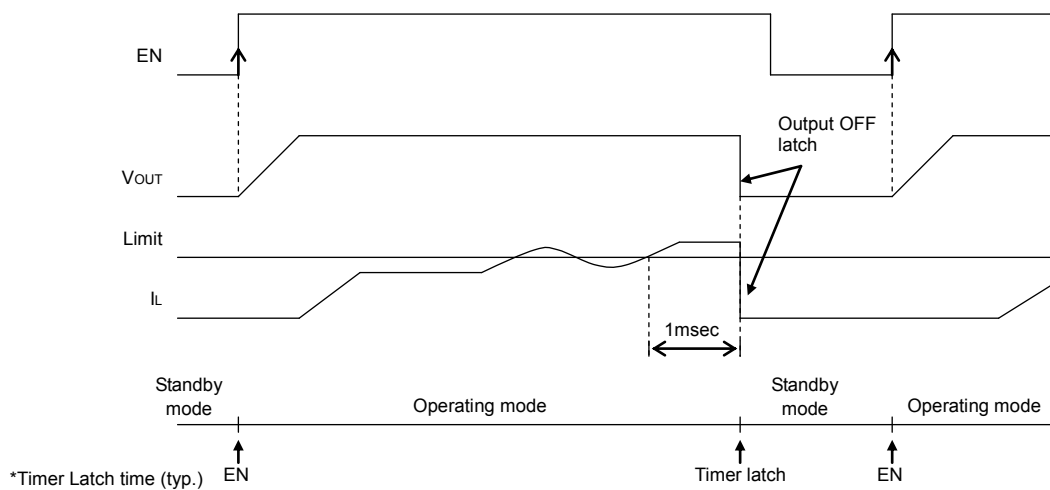

Fig.89 Short-current protection circuit with time delay timing chart

	BD9106FVM	BD9107FVM	BD9109FVM	BD9110NV	BD9120HFN	Unit
T _{LATCH}	1	1	2	1	2	msec

※ In addition to current limit circuit, output short detect circuit is built in on BD9109FVM and BD9120HFN. If output voltage fall below 2V(typ, BD9109FVM) or Vout×0.5(typ,BD9120HFN), output voltage will hold turned OFF.

● Information on Advantages

Advantage 1 : Offers fast transient response with current mode control system.

Conventional product (VOUT of which is 3.3 volts)

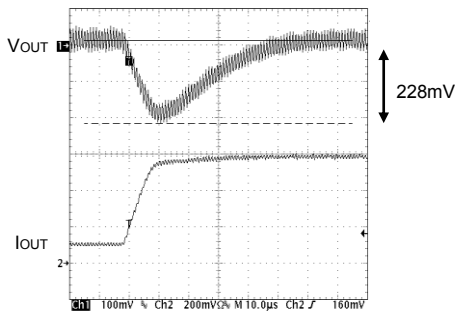

BD9109FVM (Load response I_o=100mA→600mA)

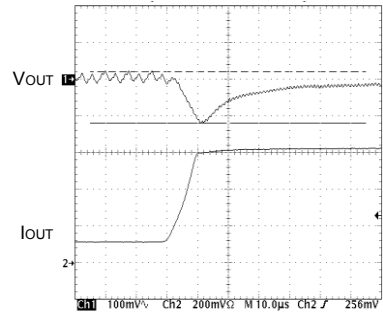

Voltage drop due to sudden change in load was reduced by about 40%.

Fig.90 Comparison of transient response

Advantage 2 : Offers high efficiency for all load range.

• For lighter load:

Utilizes the current mode control mode called SLLM™ for lighter load, which reduces various dissipation such as switching dissipation (P_{sw}), gate charge/discharge dissipation, ESR dissipation of output capacitor (P_{ESR}) and on-resistance dissipation (P_{RON}) that may otherwise cause degradation in efficiency for lighter load.



Achieves efficiency improvement for lighter load.

• For heavier load:

Utilizes the synchronous rectifying mode and the low on-resistance MOS FETs incorporated as power transistor.

- { ON resistance of P-channel MOS FET: 0.2 to 0.35 Ω (Typ.)
- { ON resistance of N-channel MOS FET: 0.15 to 0.25 Ω (Typ.)



Achieves efficiency improvement for heavier load.

Offers high efficiency for all load range with the improvements mentioned above.

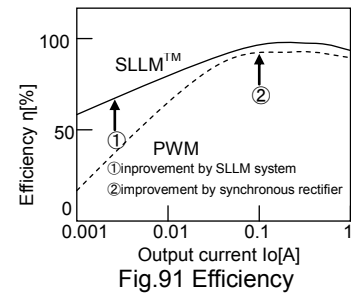

Fig.91 Efficiency

Advantage 3 : • Supplied in smaller package due to small-sized power MOS FET incorporated.

(3 package like MOSP8, HSON8, SON008V5060)

• Allows reduction in size of application products



Reduces a mounting area required.

- { Output capacitor C_o required for current mode control: 10 μF ceramic capacitor
- { Inductance L required for the operating frequency of 1 MHz: 4.7 μH inductor (BD9110NV: C_o=22μF, L=2.2μH)

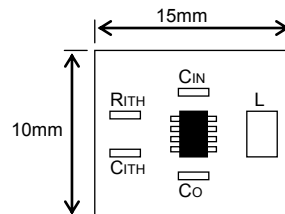
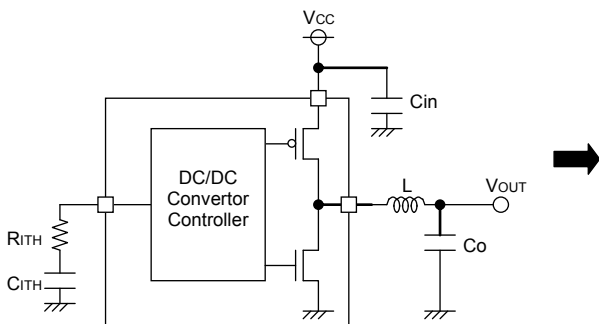

Fig.92 Example application

●Switching Regulator Efficiency

Efficiency η may be expressed by the equation shown below:

$$\eta = \frac{V_{OUT} \times I_{OUT}}{V_{IN} \times I_{IN}} \times 100[\%] = \frac{P_{OUT}}{P_{IN}} \times 100[\%] = \frac{P_{OUT}}{P_{OUT} + P_{D\alpha}} \times 100[\%]$$

Efficiency may be improved by reducing the switching regulator power dissipation factors $P_{D\alpha}$ as follows:

Dissipation factors:

- 1) ON resistance dissipation of inductor and FET : $PD(I^2R)$
- 2) Gate charge/discharge dissipation : $PD(\text{Gate})$
- 3) Switching dissipation : $PD(\text{SW})$
- 4) ESR dissipation of capacitor : $PD(\text{ESR})$
- 5) Operating current dissipation of IC : $PD(\text{IC})$

1) $PD(I^2R) = I_{OUT}^2 \times (R_{COIL} + R_{ON})$ ($R_{COIL}[\Omega]$: DC resistance of inductor, $R_{ON}[\Omega]$: ON resistance of FET, $I_{OUT}[A]$: Output current.)

2) $PD(\text{Gate}) = C_{GS} \times f \times V^2$ ($C_{GS}[F]$: Gate capacitance of FET, $f[\text{Hz}]$: Switching frequency, $V[V]$: Gate driving voltage of FET)

3) $PD(\text{SW}) = \frac{V_{IN}^2 \times C_{RSS} \times I_{OUT} \times f}{I_{DRIVE}}$ ($C_{RSS}[F]$: Reverse transfer capacitance of FET, $I_{DRIVE}[A]$: Peak current of gate.)

4) $PD(\text{ESR}) = I_{RMS}^2 \times ESR$ ($I_{RMS}[A]$: Ripple current of capacitor, $ESR[\Omega]$: Equivalent series resistance.)

5) $PD(\text{IC}) = V_{IN} \times I_{CC}$ ($I_{CC}[A]$: Circuit current.)

●Consideration on Permissible Dissipation and Heat Generation

As this IC functions with high efficiency without significant heat generation in most applications, no special consideration is needed on permissible dissipation or heat generation. In case of extreme conditions, however, including lower input voltage, higher output voltage, heavier load, and/or higher temperature, the permissible dissipation and/or heat generation must be carefully considered.

For dissipation, only conduction losses due to DC resistance of inductor and ON resistance of FET are considered. Because the conduction losses are considered to play the leading role among other dissipation mentioned above including gate charge/discharge dissipation and switching dissipation.

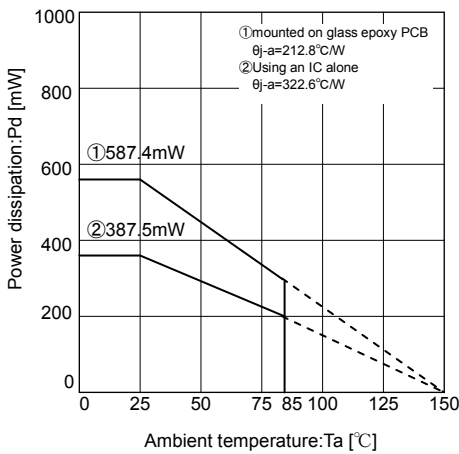

Fig.93 Thermal derating curve (MSOP8)

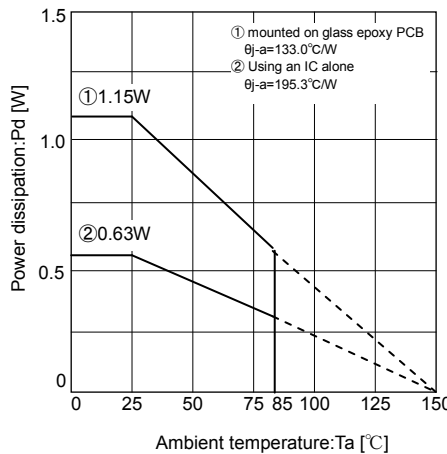

Fig.94 Thermal derating curve (HSO8)

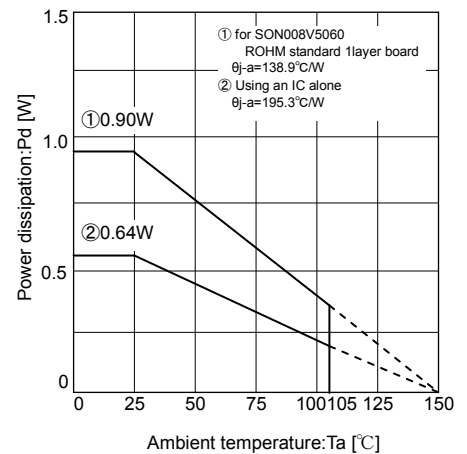

Fig.95 Thermal derating curve (SON008V5060)

If $V_{CC}=5V$, $V_{OUT}=3.3V$, $R_{COIL}=0.15\Omega$, $R_{ONP}=0.35\Omega$, $R_{ONN}=0.25\Omega$
 $I_{OUT}=0.8A$, for example,
 $D = V_{OUT}/V_{CC} = 3.3/5 = 0.66$
 $R_{ON} = 0.66 \times 0.35 + (1 - 0.66) \times 0.25$
 $= 0.231 + 0.085$
 $= 0.316[\Omega]$
 $P = 0.8^2 \times (0.15 + 0.316)$
 $\approx 298[mW]$

$$P = I_{OUT}^2 \times (R_{COIL} + R_{ON})$$

$$R_{ON} = D \times R_{ONP} + (1 - D) \times R_{ONN}$$

- D : ON duty (= V_{OUT}/V_{CC})
- R_{COIL} : DC resistance of coil
- R_{ONP} : ON resistance of P-channel MOS FET
- R_{ONN} : ON resistance of N-channel MOS FET
- I_{OUT} : Output current

As R_{ONP} is greater than R_{ONN} in this IC, the dissipation increases as the ON duty becomes greater. With the consideration on the dissipation as above, thermal design must be carried out with sufficient margin allowed.

● Selection of Components Externally Connected

1. Selection of inductor (L)

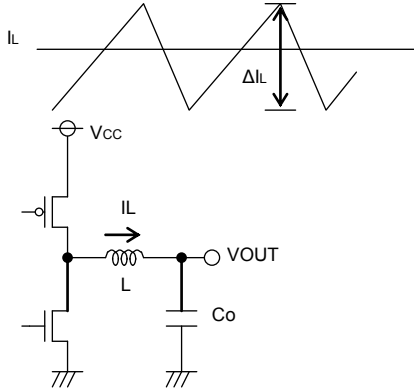

Fig.96 Output ripple current

The inductance significantly depends on output ripple current. As seen in the equation (1), the ripple current decreases as the inductor and/or switching frequency increases.

$$\Delta I_L = \frac{(V_{CC}-V_{OUT}) \times V_{OUT}}{L \times V_{CC} \times f} \quad [A] \dots (1)$$

Appropriate ripple current at output should be 30% more or less of the maximum output current.

$$\Delta I_L = 0.3 \times I_{OUTmax} \quad [A] \dots (2)$$

$$L = \frac{(V_{CC}-V_{OUT}) \times V_{OUT}}{\Delta I_L \times V_{CC} \times f} \quad [H] \dots (3)$$

(ΔI_L : Output ripple current, and f: Switching frequency)

* Current exceeding the current rating of the inductor results in magnetic saturation of the inductor, which decreases efficiency. The inductor must be selected allowing sufficient margin with which the peak current may not exceed its current rating.

If $V_{CC}=5V$, $V_{OUT}=3.3V$, $f=1MHz$, $\Delta I_L=0.3 \times 0.8A=0.24A$, for example, (BD9109FVM)

$$L = \frac{(5-3.3) \times 3.3}{0.24 \times 5 \times 1M} = 4.675 \mu \rightarrow 4.7 [\mu H]$$

* Select the inductor of low resistance component (such as DCR and ACR) to minimize dissipation in the inductor for better efficiency.

2. Selection of output capacitor (Co)

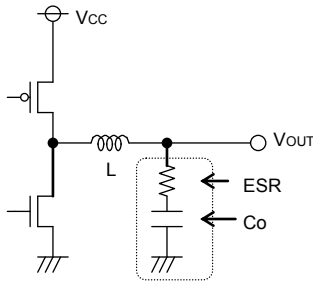

Fig.97 Output capacitor

Output capacitor should be selected with the consideration on the stability region and the equivalent series resistance required to smooth ripple voltage. Output ripple voltage is determined by the equation (4) :

$$\Delta V_{OUT} = \Delta I_L \times ESR \quad [V] \dots (4)$$

(ΔI_L : Output ripple current, ESR: Equivalent series resistance of output capacitor)

*Rating of the capacitor should be determined allowing sufficient margin against output voltage. Less ESR allows reduction in output ripple voltage.

As the output rise time must be designed to fall within the soft-start time, the capacitance of output capacitor should be determined with consideration on the requirements of equation (5):

$$C_o \leq \frac{T_{SS} \times (I_{limit} - I_{OUT})}{V_{OUT}} \dots (5) \quad \left[\begin{array}{l} T_{SS}: \text{Soft-start time} \\ I_{limit}: \text{Over current detection level, 2A(Typ)} \end{array} \right]$$

In case of BD9109FVM, for instance, and if $V_{OUT}=3.3V$, $I_{OUT}=0.8A$, and $T_{SS}=1ms$,

$$C_o \leq \frac{1m \times (2-0.8)}{3.3} \approx 364 [\mu F]$$

Inappropriate capacitance may cause problem in startup. A 10 μF to 100 μF ceramic capacitor is recommended.

3. Selection of input capacitor (Cin)

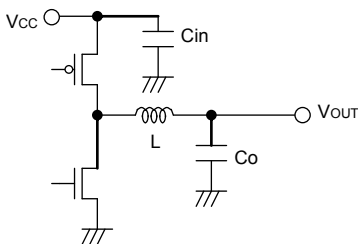

Fig.98 Input capacitor

Input capacitor to select must be a low ESR capacitor of the capacitance sufficient to cope with high ripple current to prevent high transient voltage. The ripple current I_{RMS} is given by the equation (6):

$$I_{RMS} = I_{OUT} \times \frac{\sqrt{V_{OUT}(V_{CC}-V_{OUT})}}{V_{CC}} \quad [A] \dots (6)$$

< Worst case > $I_{RMS(max)}$

When V_{CC} is twice the V_{out} , $\frac{I_{OUT}}{2}$

If $V_{CC}=5V$, $V_{OUT}=3.3V$, and $I_{OUTmax}=0.8A$, (BD9109FVM)

$$I_{RMS} = 0.8 \times \frac{\sqrt{3.3(5-3.3)}}{5} = 0.38 [ARMS]$$

A low ESR 10 μF /10V ceramic capacitor is recommended to reduce ESR dissipation of input capacitor for better efficiency.

4. Determination of RITH, CITH that works as a phase compensator

As the Current Mode Control is designed to limit a inductor current, a pole (phase lag) appears in the low frequency area due to a CR filter consisting of a output capacitor and a load resistance, while a zero (phase lead) appears in the high frequency area due to the output capacitor and its ESR. So, the phases are easily compensated by adding a zero to the power amplifier output with C and R as described below to cancel a pole at the power amplifier.

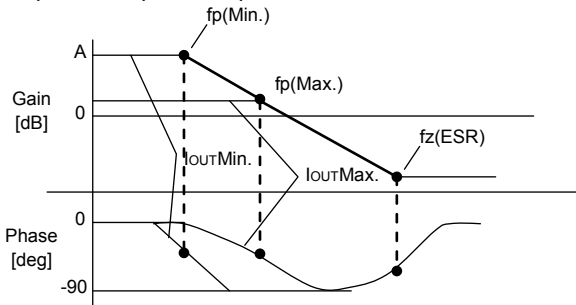

Fig.99 Open loop gain characteristics

$$f_p = \frac{1}{2\pi \times R_o \times C_o}$$

$$f_z(ESR) = \frac{1}{2\pi \times ESR \times C_o}$$

Pole at power amplifier

When the output current decreases, the load resistance R_o increases and the pole frequency lowers.

$$f_{p(Min.)} = \frac{1}{2\pi \times R_{OMax.} \times C_o} \text{ [Hz]} \leftarrow \text{with lighter load}$$

$$f_{p(Max.)} = \frac{1}{2\pi \times R_{OMin.} \times C_o} \text{ [Hz]} \leftarrow \text{with heavier load}$$

Zero at power amplifier

Increasing capacitance of the output capacitor lowers the pole frequency while the zero frequency does not change. (This is because when the capacitance is doubled, the capacitor ESR reduces to half.)

$$f_z(Amp.) = \frac{1}{2\pi \times R_{ITH} \times C_{ITH}}$$

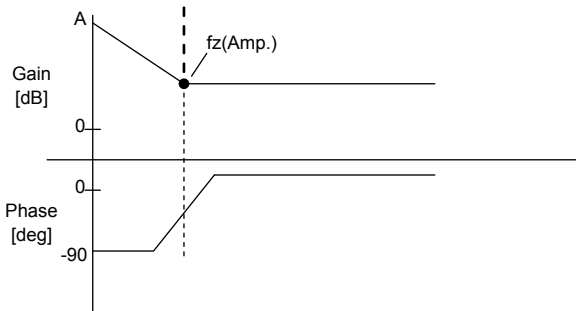

Fig.100 Error amp phase compensation characteristics

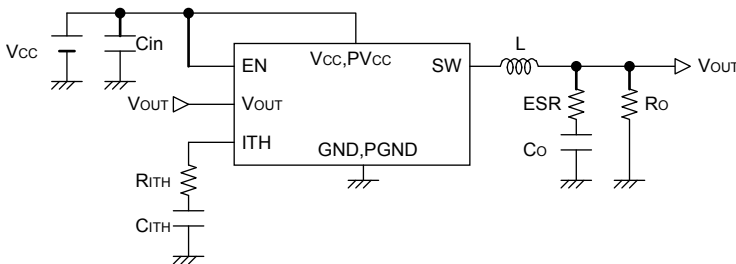

Fig.101 Typical application

Stable feedback loop may be achieved by canceling the pole f_p (Min.) produced by the output capacitor and the load resistance with CR zero correction by the error amplifier.

$$f_z(Amp.) = f_p(Min.)$$

$$\rightarrow \frac{1}{2\pi \times R_{ITH} \times C_{ITH}} = \frac{1}{2\pi \times R_{OMax.} \times C_o}$$

5. Determination of output voltage

The output voltage V_{OUT} is determined by the equation (7):
 $V_{OUT} = (R_2/R_1 + 1) \times V_{ADJ}$. . . (7) V_{ADJ} : Voltage at ADJ terminal (0.8V Typ.)
 With R_1 and R_2 adjusted, the output voltage may be determined as required.
 Adjustable output voltage range : 1.0V to 1.5V/ BD9107FVM, BD9120HFN }
 1.0V to 2.5V/BD106FVM, BD9110NV }
 Use 1 kΩ to 100 kΩ resistor for R_1 . If a resistor of the resistance higher than 100 kΩ is used, check the assembled set carefully for ripple voltage etc.

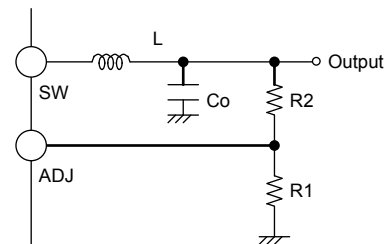

Fig.102 Determination of output voltage

●Cautions on PC Board layout

BD9106FVM, BD9107FVM, BD9109FVM, BD9120HFN

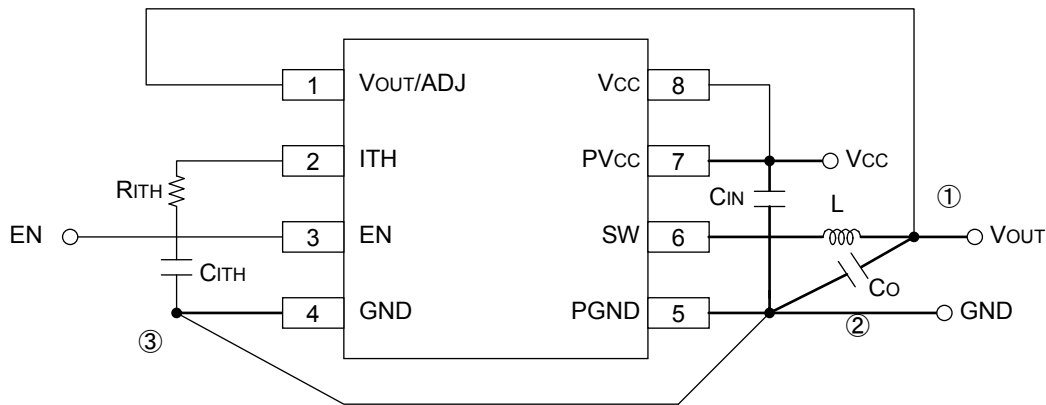

Fig.103 Layout diagram

BD9110NV Cautions on PC Board layout

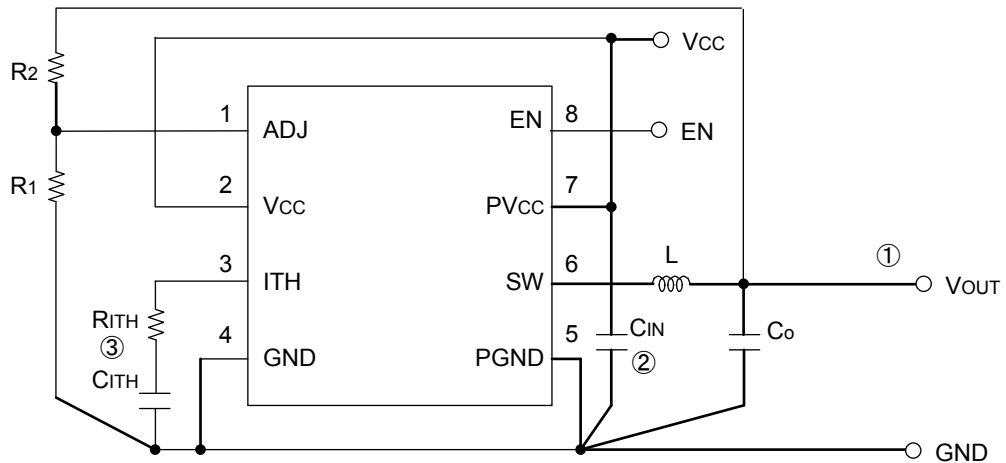

Fig.104 Layout diagram

- ① For the sections drawn with heavy line, use thick conductor pattern as short as possible.
- ② Lay out the input ceramic capacitor CIN closer to the pins PVCC and PGND, and the output capacitor Co closer to the pin PGND.
- ③ Lay out CITH and RITH between the pins ITH and GND as neat as possible with least necessary wiring.

※ The package of HSON8 (BD9120HFN) and SON008V5050 (BD9110NV) has thermal FIN on the reverse of the package. The package thermal performance may be enhanced by bonding the FIN to GND plane which take a large area of PCB.

●Recommended components Lists on above application

Table1. [BD9106FVM]

Symbol	Part	Value		Manufacturer	Series
L	Coil	4.7μH		Sumida	CMD6D11B
				TDK	VLF5014AT-4R7M1R1
CIN	Ceramic capacitor	10μF		Kyocera	CM316X5R106K10A
Co	Ceramic capacitor	10μF		Kyocera	CM316X5R106K10A
CITH	Ceramic capacitor	750pF		murata	GRM18series
RITH	Resistance	VOUT=1.0V	18kΩ	ROHM	MCR10 1802
		VOUT=1.2V	22kΩ	ROHM	MCR10 2202
		VOUT=1.5V	22kΩ	ROHM	MCR10 2202
		VOUT=1.8V	27kΩ	ROHM	MCR10 2702
		VOUT=2.5V	36kΩ	ROHM	MCR10 3602

Table2. [BD9107FVM]

Symbol	Part	Value		Manufacturer	Series
L	Coil	4.7μH		Sumida	CMD6D11B
				TDK	VLF5014AT-4R7M1R1
CIN	Ceramic capacitor	10μF		Kyocera	CM316X5R106K10A
Co	Ceramic capacitor	10μF		Kyocera	CM316X5R106K10A
C1TH	Ceramic capacitor	1000pF		murata	GRM18series
R1TH	Resistance	VOUT=1.0V	4.3kΩ	ROHM	MCR10 4301
		VOUT=1.2V	6.8kΩ	ROHM	MCR10 6801
		VOUT=1.5V	9.1kΩ	ROHM	MCR10 9101
		VOUT=1.8V	12kΩ	ROHM	MCR10 1202

Table3. [BD9109VM]

Symbol	Part	Value		Manufacturer	Series
L	Coil	4.7μH		Sumida	CMD6D11B
				TDK	VLF5014AT-4R7M1R1
CIN	Ceramic capacitor	10μF		Kyocera	CM316X5R106K10A
Co	Ceramic capacitor	10μF		Kyocera	CM316X5R106K10A
C1TH	Ceramic capacitor	330pF		murata	GRM18series
R1TH	Resistance	30kΩ		ROHM	MCR10 3002

Table4. [BD9110NV]

Symbol	Part	Value		Manufacturer	Series
L	Coil	2.2μH		TDK	LTF5022T-2R2N3R2
CIN	Ceramic capacitor	10μF		Kyocera	CM316X5R106K10A
Co	Ceramic capacitor	22μF		Kyocera	CM316B226K06A
C1TH	Ceramic capacitor	1000pF		murata	GRM18series
R1TH	Resistance	VOUT=1.0V	12kΩ	ROHM	MCR10 1202
		VOUT=1.2V			
		VOUT=1.5V			
		VOUT=1.8V			
		VOUT=2.5V			

Table5. [BD9120HFN]

Symbol	Part	Value		Manufacturer	Series
L	Coil	4.7μH		Sumida	CMD6D11B
				TDK	VLF5014AT-4R7M1R1
CIN	Ceramic capacitor	10μF		Kyocera	CM316X5R106K10A
Co	Ceramic capacitor	10μF		Kyocera	CM316X5R106K10A
C1TH	Ceramic capacitor	680pF		murata	GRM18series
R1TH	Resistance	VOUT=1.0V	8.2kΩ	ROHM	MCR10 8201
		VOUT=1.2V	8.2kΩ	ROHM	MCR10 8201
		VOUT=1.5V	4.7kΩ	ROHM	MCR10 4701

*The parts list presented above is an example of recommended parts. Although the parts are sound, actual circuit characteristics should be checked on your application carefully before use. Be sure to allow sufficient margins to accommodate variations between external devices and this IC when employing the depicted circuit with other circuit constants modified. Both static and transient characteristics should be considered in establishing these margins. When switching noise is substantial and may impact the system, a low pass filter should be inserted between the VCC and PVCC pins, and a schottky barrier diode established between the SW and PGND pins.

● I/O Equivalence Circuit

【BD9106FVM, BD9107FVM, BD9109FVM】

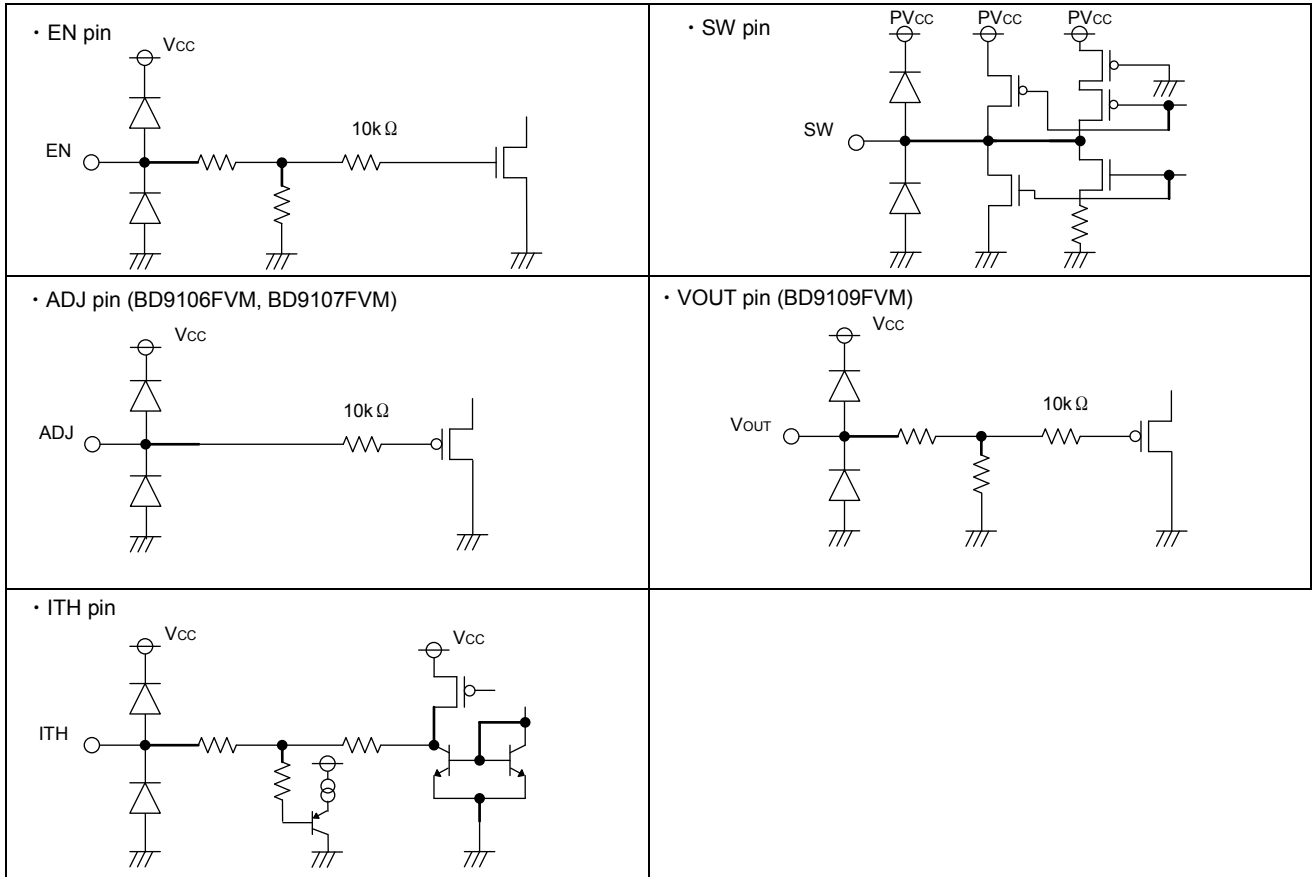

【BD9110NV, BD9120HFN】

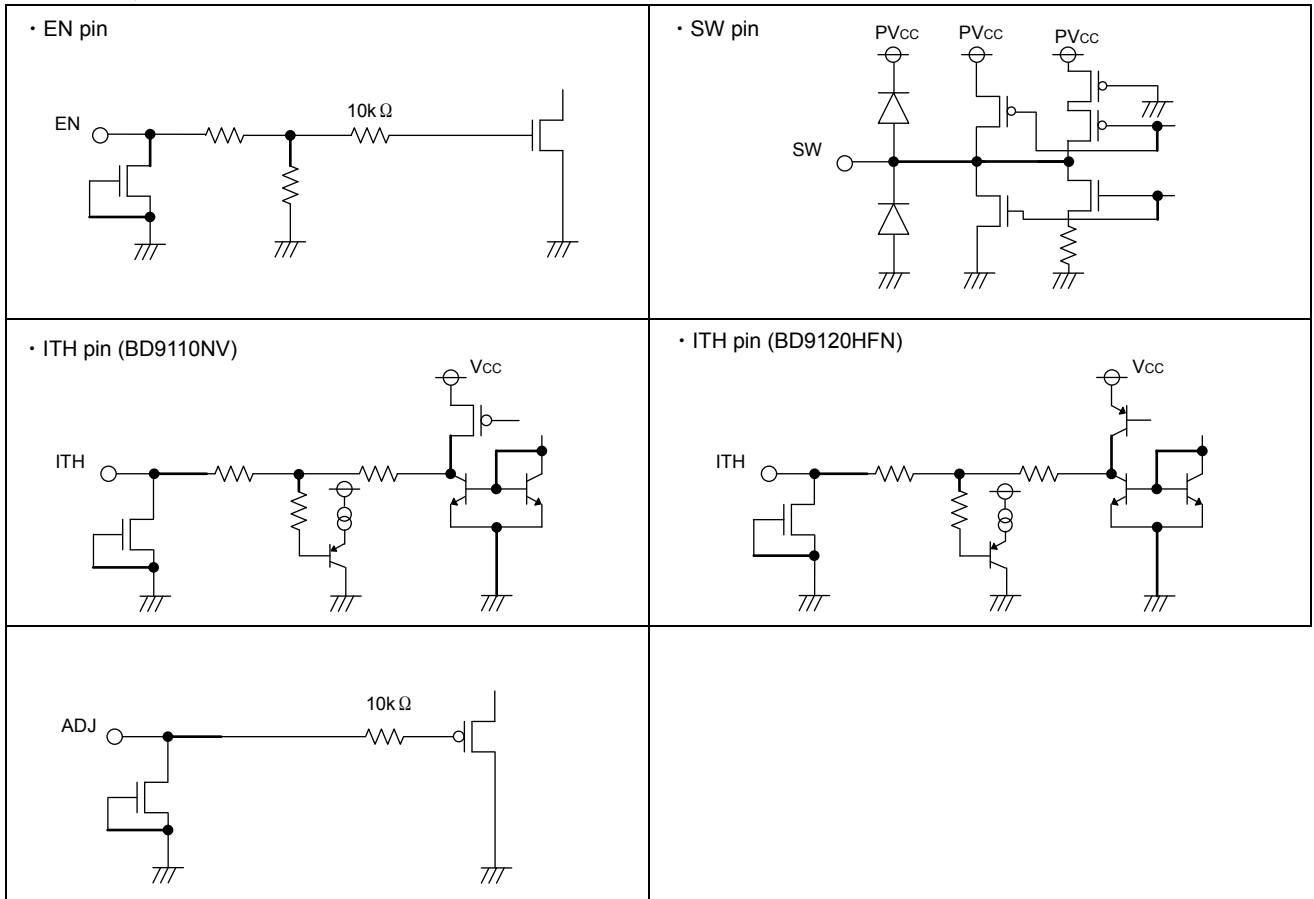

Fig.105 I/O equivalence circuit

●Operational Notes

1. Absolute Maximum Ratings

While utmost care is taken to quality control of this product, any application that may exceed some of the absolute maximum ratings including the voltage applied and the operating temperature range may result in breakage. If broken, short-mode or open-mode may not be identified. So if it is expected to encounter with special mode that may exceed the absolute maximum ratings, it is requested to take necessary safety measures physically including insertion of fuses.

2. Electrical potential at GND

GND must be designed to have the lowest electrical potential In any operating conditions.

3. Short-circuiting between terminals, and mismounting

When mounting to pc board, care must be taken to avoid mistake in its orientation and alignment. Failure to do so may result in IC breakdown. Short-circuiting due to foreign matters entered between output terminals, or between output and power supply or GND may also cause breakdown.

4. Operation in Strong electromagnetic field}

Be noted that using the IC in the strong electromagnetic radiation can cause operation failures.

5. Thermal shutdown protection circuit

Thermal shutdown protection circuit is the circuit designed to isolate the IC from thermal runaway, and not intended to protect and guarantee the IC. So, the IC the thermal shutdown protection circuit of which is once activated should not be used thereafter for any operation originally intended.

6. Inspection with the IC set to a pc board

If a capacitor must be connected to the pin of lower impedance during inspection with the IC set to a pc board, the capacitor must be discharged after each process to avoid stress to the IC. For electrostatic protection, provide proper grounding to assembling processes with special care taken in handling and storage. When connecting to jigs in the inspection process, be sure to turn OFF the power supply before it is connected and removed.

7. Input to IC terminals

This is a monolithic IC with P⁺ isolation between P-substrate and each element as illustrated below. This P-layer and the N-layer of each element form a P-N junction, and various parasitic element are formed.

If a resistor is joined to a transistor terminal as shown in Fig 106:

OP-N junction works as a parasitic diode if the following relationship is satisfied; GND>Terminal A (at resistor side), or GND>Terminal B (at transistor side); and

Oif GND>Terminal B (at NPN transistor side),

a parasitic NPN transistor is activated by N-layer of other element adjacent to the above-mentioned parasitic diode.

The structure of the IC inevitably forms parasitic elements, the activation of which may cause interference among circuits, and/or malfunctions contributing to breakdown. It is therefore requested to take care not to use the device in such manner that the voltage lower than GND (at P-substrate) may be applied to the input terminal, which may result in activation of parasitic elements.

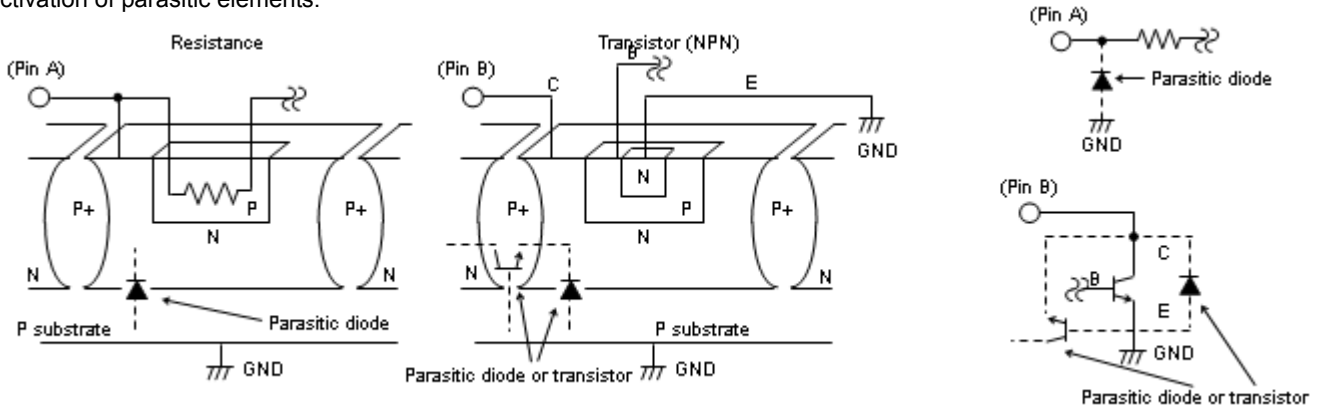

Fig.106 Simplified structure of monoristic IC

8. Ground wiring pattern

If small-signal GND and large-current GND are provided, It will be recommended to separate the large-current GND pattern from the small-signal GND pattern and establish a single ground at the reference point of the set PCB so that resistance to the wiring pattern and voltage fluctuations due to a large current will cause no fluctuations in voltages of the small-signal GND. Pay attention not to cause fluctuations in the GND wiring pattern of external parts as well.

Status of this document

The Japanese version of this document is formal specification. A customer may use this translation version only for a reference to help reading the formal version.

If there are any differences in translation version of this document formal version takes priority.

●Physical Dimensions Tape and Reel information

MSOP8

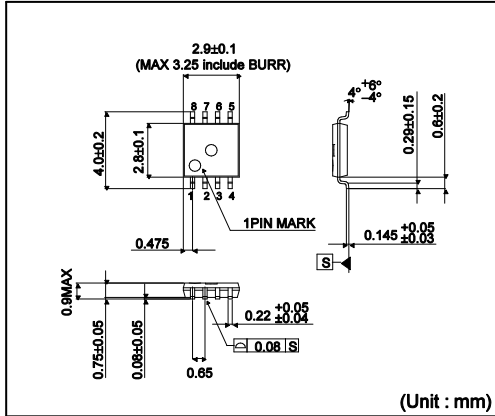

<Tape and Reel information>

Tape	Embossed carrier tape
Quantity	3000pcs
Direction of feed	TR (The direction is the 1pin of product is at the upper right when you hold reel on the left hand and you pull out the tape on the right hand)

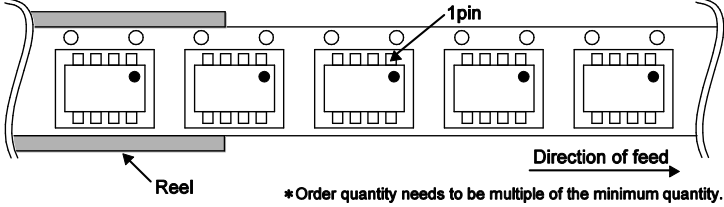

HSOP8

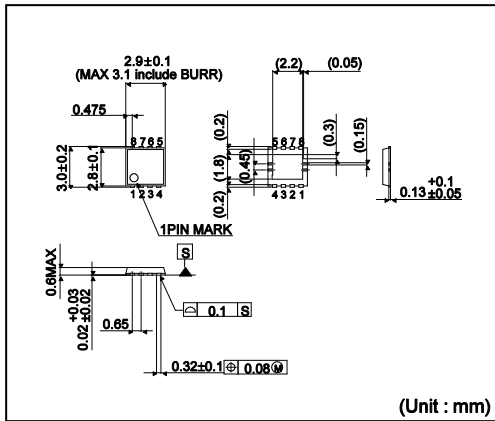

<Tape and Reel information>

Tape	Embossed carrier tape
Quantity	3000pcs
Direction of feed	TR (The direction is the 1pin of product is at the upper right when you hold reel on the left hand and you pull out the tape on the right hand)

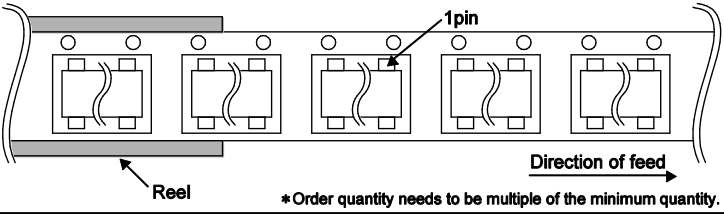

SON008V5060

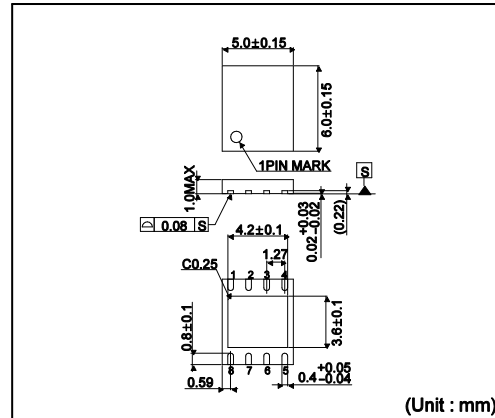

<Tape and Reel information>

Tape	Embossed carrier tape
Quantity	2000pcs
Direction of feed	E2 (The direction is the 1pin of product is at the upper left when you hold reel on the left hand and you pull out the tape on the right hand)

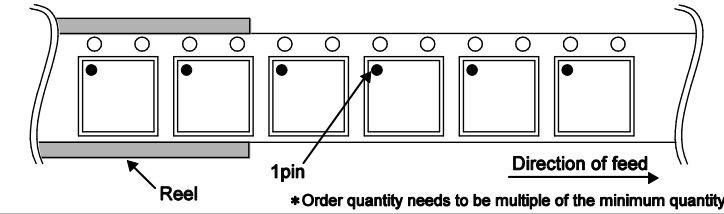

● Marking Diagrams

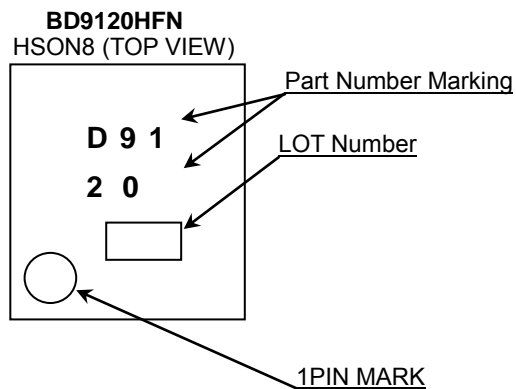
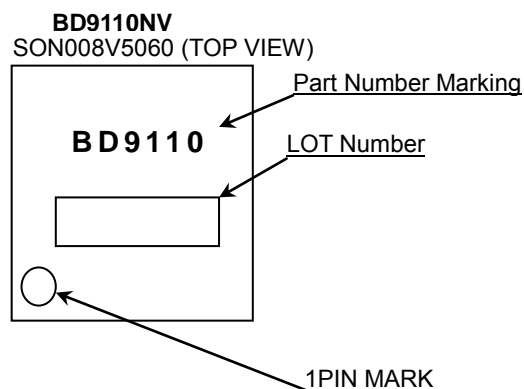
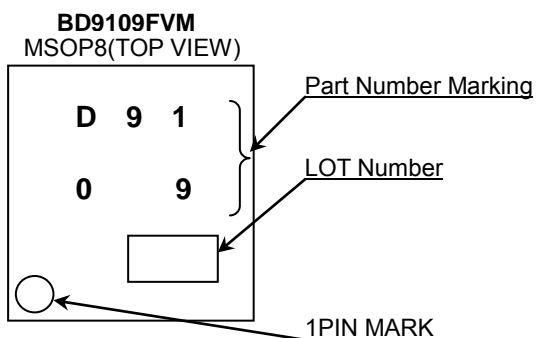
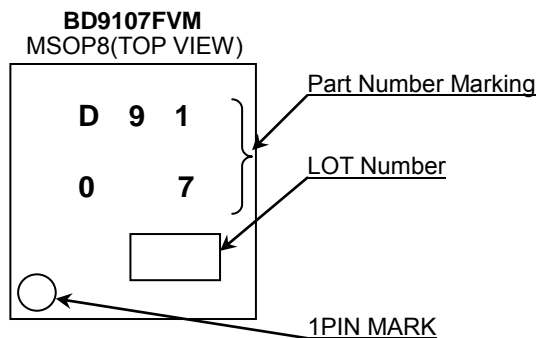
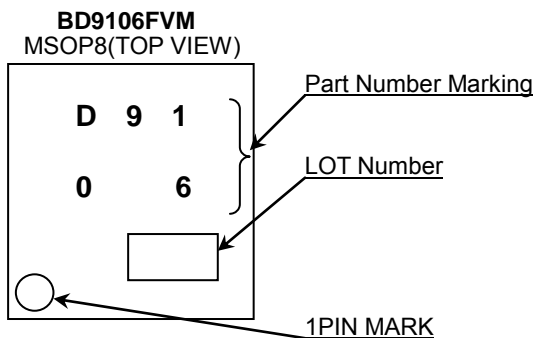

●Revision History

Date	Revision	Changes
17.Jan.2012	001	New Release

Notice

●Precaution for circuit design

- 1) The products are designed and produced for application in ordinary electronic equipment (AV equipment, OA equipment, telecommunication equipment, home appliances, amusement equipment, etc.). If the products are to be used in devices requiring extremely high reliability (medical equipment, transport equipment, aircraft/spacecraft, nuclear power controllers, fuel controllers, car equipment including car accessories, safety devices, etc.) and whose malfunction or operational error may endanger human life and sufficient fail-safe measures, please consult with the ROHM sales staff in advance. If product malfunctions may result in serious damage, including that to human life, sufficient fail-safe measures must be taken, including the following:
 - [a] Installation of protection circuits or other protective devices to improve system safety
 - [b] Installation of redundant circuits in the case of single-circuit failure
- 2) The products are designed for use in a standard environment and not in any special environments. Application of the products in a special environment can deteriorate product performance. Accordingly, verification and confirmation of product performance, prior to use, is recommended if used under the following conditions:
 - [a] Use in various types of liquid, including water, oils, chemicals, and organic solvents
 - [b] Use outdoors where the products are exposed to direct sunlight, or in dusty places
 - [c] Use in places where the products are exposed to sea winds or corrosive gases, including Cl₂, H₂S, NH₃, SO₂, and NO₂
 - [d] Use in places where the products are exposed to static electricity or electromagnetic waves
 - [e] Use in proximity to heat-producing components, plastic cords, or other flammable items
 - [f] Use involving sealing or coating the products with resin or other coating materials
 - [g] Use involving unclean solder or use of water or water-soluble cleaning agents for cleaning after soldering
 - [h] Use of the products in places subject to dew condensation
- 3) The products are not radiation resistant.
- 4) Verification and confirmation of performance characteristics of products, after on-board mounting, is advised.
- 5) In particular, if a transient load (a large amount of load applied in a short period of time, such as pulse) is applied, confirmation of performance characteristics after on-board mounting is strongly recommended. Avoid applying power exceeding normal rated power; exceeding the power rating under steady-state loading condition may negatively affect product performance and reliability.
- 6) De-rate Power Dissipation (Pd) depending on Ambient temperature (Ta).
When used in sealed area, confirm the actual ambient temperature.
- 7) Confirm that operation temperature is within the specified range described in product specification.
- 8) Failure induced under deviant condition from what defined in the product specification cannot be guaranteed.

●Precaution for Mounting / Circuit board design

- 1) When a highly active halogenous (chlorine, bromine, etc.) flux is used, the remainder of flux may negatively affect product performance and reliability.
- 2) In principle, the reflow soldering method must be used; if flow soldering method is preferred, please consult with the Company in advance.

Regarding Precaution for Mounting / Circuit board design, please specially refer to ROHM Mounting specification

●Precautions Regarding Application Examples and External Circuits

- 1) If change is made to the constant of an external circuit, allow a sufficient margin due to variations of the characteristics of the products and external components, including transient characteristics, as well as static characteristics.
- 2) The application examples, their constants, and other types of information contained herein are applicable only when the products are used in accordance with standard methods. Therefore, if mass production is intended, sufficient consideration to external conditions must be made.

● **Precaution for Electrostatic**

This product is Electrostatic sensitive product, which may be damaged due to Electrostatic discharge. Please take proper caution during manufacturing and storing so that voltage exceeding Product maximum rating won't be applied to products. Please take special care under dry condition (e.g. Grounding of human body / equipment / solder iron, isolation from charged objects, setting of Ionizer, friction prevention and temperature / humidity control).

● **Precaution for Storage / Transportation**

- 1) Product performance and soldered connections may deteriorate if the products are stored in the following places:
 - [a] Where the products are exposed to sea winds or corrosive gases, including Cl₂, H₂S, NH₃, SO₂, and NO₂
 - [b] Where the temperature or humidity exceeds those recommended by the Company
 - [c] Storage in direct sunshine or condensation
 - [d] Storage in high Electrostatic
- 2) Even under ROHM recommended storage condition, solderability of products out of recommended storage time period may be degraded. It is strongly recommended to confirm solderability before using products of which storage time is exceeding recommended storage time period .
- 3) Store / transport cartons in the correct direction, which is indicated on a carton as a symbol. Otherwise bent leads may occur due to excessive stress applied when dropping of a carton.
- 4) Use products within the specified time after opening a dry bag.

● **Precaution for product label**

QR code printed on ROHM product label is only for internal use, and please do not use at customer site. It might contain a internal part number that is inconsistent with an product part number.

● **Precaution for disposition**

When disposing products please dispose them properly with a industry waste company.

● **Precaution for Foreign exchange and Foreign trade act**

Since concerned goods might be fallen under controlled goods prescribed by Foreign exchange and Foreign trade act, please consult with ROHM in case of export.

● **Prohibitions Regarding Industrial Property**

- 1) Information and data on products, including application examples, contained in these specifications are simply for reference; the Company does not guarantee any industrial property rights, intellectual property rights, or any other rights of a third party regarding this information or data. Accordingly, the Company does not bear any responsibility for:
 - [a] infringement of the intellectual property rights of a third party
 - [b] any problems incurred by the use of the products listed herein.
- 2) The Company prohibits the purchaser of its products to exercise or use the intellectual property rights, industrial property rights, or any other rights that either belong to or are controlled by the Company, other than the right to use, sell, or dispose of the products.



Стандарт Электрон Связь

Мы молодая и активно развивающаяся компания в области поставок электронных компонентов. Мы поставляем электронные компоненты отечественного и импортного производства напрямую от производителей и с крупнейших складов мира.

Благодаря сотрудничеству с мировыми поставщиками мы осуществляем комплексные и плановые поставки широчайшего спектра электронных компонентов.

Собственная эффективная логистика и склад в обеспечивает надежную поставку продукции в точно указанные сроки по всей России.

Мы осуществляем техническую поддержку нашим клиентам и предпродажную проверку качества продукции. На все поставляемые продукты мы предоставляем гарантию .

Осуществляем поставки продукции под контролем ВП МО РФ на предприятия военно-промышленного комплекса России , а также работаем в рамках 275 ФЗ с открытием отдельных счетов в уполномоченном банке. Система менеджмента качества компании соответствует требованиям ГОСТ ISO 9001.

Минимальные сроки поставки, гибкие цены, неограниченный ассортимент и индивидуальный подход к клиентам являются основой для выстраивания долгосрочного и эффективного сотрудничества с предприятиями радиоэлектронной промышленности, предприятиями ВПК и научно-исследовательскими институтами России.

С нами вы становитесь еще успешнее!

Наши контакты:

Телефон: +7 812 627 14 35

Электронная почта: sales@st-electron.ru

Адрес: 198099, Санкт-Петербург,
Промышленная ул, дом № 19, литера Н,
помещение 100-Н Офис 331