

High accuracy (200 μV) micropower 14 μA , 150 kHz
5 V CMOS operational amplifiers

Datasheet - preliminary data

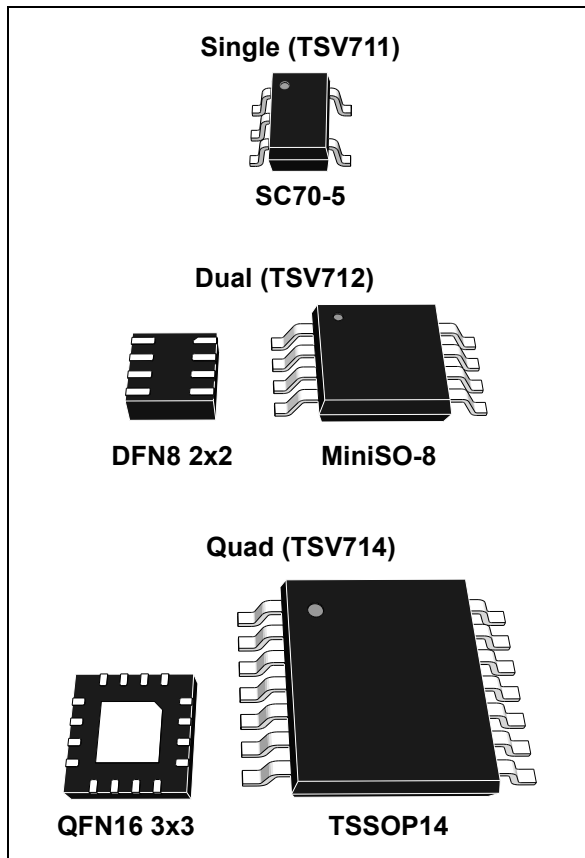

Features

- Low offset voltage: 200 μV max.
- Low power consumption: 10 μA at 5 V
- Low supply voltage: 1.5 V to 5.5 V
- Gain bandwidth product: 150 kHz typ.
- Low input bias current: 1 pA typ.
- Rail-to-rail input and output
- EMI hardened operational amplifiers
- High tolerance to ESD: 4 kV HBM
- Extended temperature range: -40 to +125 $^{\circ}\text{C}$

Benefits

- Higher accuracy without calibration
- Energy saving
- Guaranteed operation on low-voltage battery

Related products

- See the TSV73 series (900 kHz for 60 μA) for higher gain bandwidth products

Applications

- Battery powered applications
- Portable devices
- Signal conditioning
- Active filtering
- Medical instrumentation

Description

The TSV71x series of single, dual, and quad operational amplifiers offer low-voltage operation, rail-to-rail input and output, and excellent accuracy (V_{io} lower than 200 μV at 25 $^{\circ}\text{C}$).

These devices benefit from STMicroelectronics[®] 5 V CMOS technology and offer an excellent speed/power consumption ratio (150 kHz typical gain bandwidth) while consuming less than 14 μA at 5 V. The TSV71x series also feature an ultra-low input bias current.

The single version (TSV711), the dual version (TSV712), and the quad version (TSV714) are housed in the smallest industrial packages.

These characteristics make the TSV71x family ideal for sensor interfaces, battery-powered and portable applications, and active filtering.

Contents

- 1 Pin connections 3**
- 2 Absolute maximum ratings and operating conditions 4**
- 3 Electrical characteristics 6**
- 4 Application information 16**
 - 4.1 Operating voltages 16
 - 4.2 Rail-to-rail input 16
 - 4.3 Rail-to-rail output 16
 - 4.4 Input offset voltage drift over temperature 16
 - 4.5 Long-term input offset voltage drift 17
 - 4.6 Initialization time 19
 - 4.7 PCB layouts 19
 - 4.8 Macromodel 20
- 5 Package information 21**
 - 5.1 SC70-5 package information 22
 - 5.2 DFN8 2x2 package information 23
 - 5.3 MiniSO-8 package information 24
 - 5.4 QFN16 3x3 package information 25
 - 5.5 TSSOP14 package information 27
- 6 Ordering information 28**
- 7 Revision history 28**

1 Pin connections

Figure 1. Pin connections (top view)

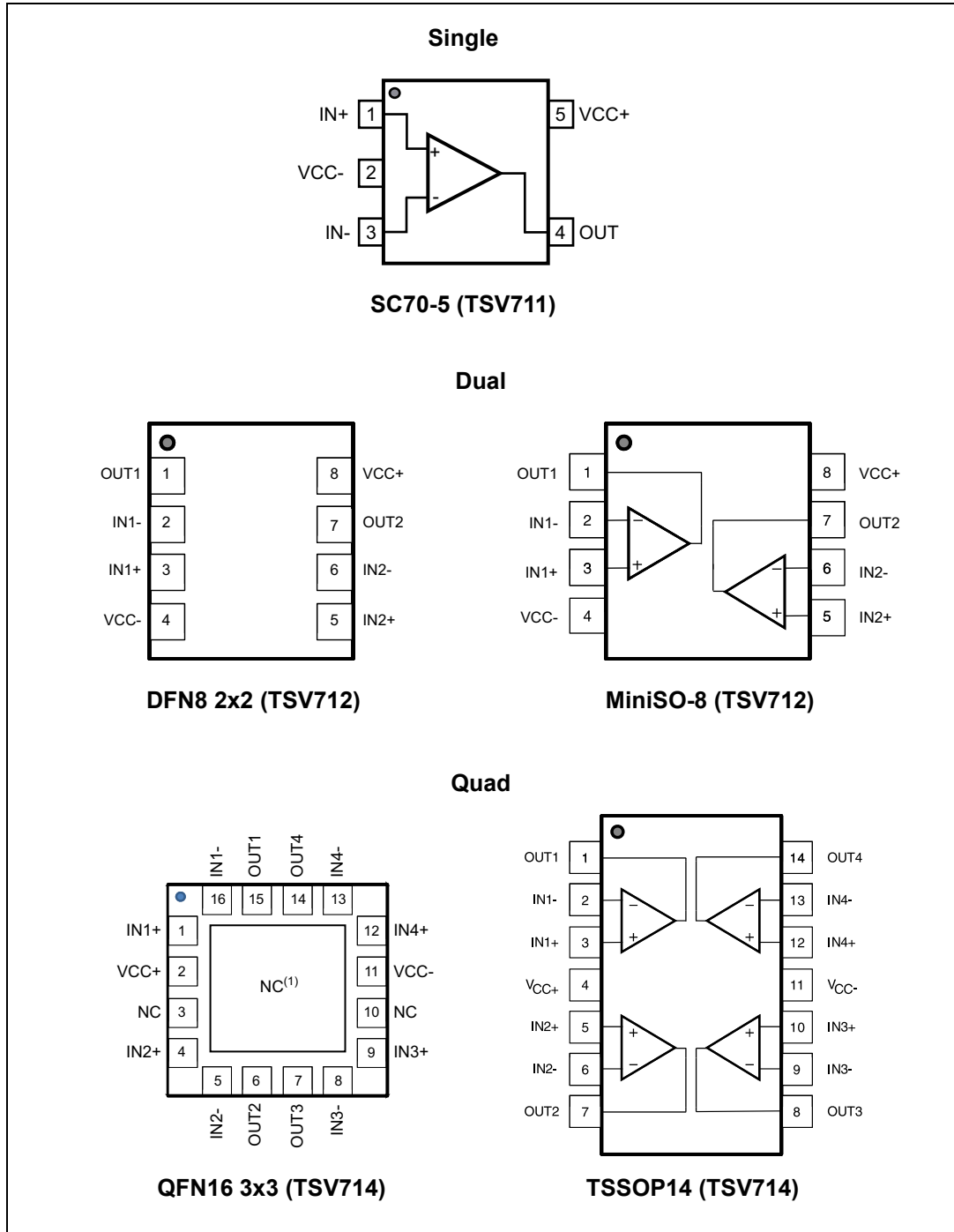

1. The exposed pads of the QFN16 3x3 can be connected to VCC- or left floating.

2 Absolute maximum ratings and operating conditions

Table 1. Absolute maximum ratings (AMR)

| Symbol | Parameter | Value | Unit |
|------------|--|------------------------------------|------|
| V_{CC} | Supply voltage ⁽¹⁾ | 6 | V |
| V_{id} | Differential input voltage ⁽²⁾ | $\pm V_{CC}$ | |
| V_{in} | Input voltage ⁽³⁾ | $V_{CC-} - 0.2$ to $V_{CC+} + 0.2$ | |
| I_{in} | Input current ⁽⁴⁾ | 10 | mA |
| T_{stg} | Storage temperature | -65 to +150 | °C |
| R_{thja} | Thermal resistance junction-to-ambient ⁽⁵⁾⁽⁶⁾ | | °C/W |
| | SC70-5 | 205 | |
| | DFN8 2x2 | 120 | |
| | MiniSO8 | 190 | |
| | QFN16 3x3 | 45 | |
| | TSSOP14 | 100 | |
| R_{thjc} | Thermal resistance junction-to-case DFN8 2x2 | 33 | |
| T_j | Maximum junction temperature | 150 | °C |
| ESD | HBM: human body model ⁽⁷⁾ | 4 | kV |
| | MM: machine model for TSV711 ⁽⁸⁾ | 150 | V |
| | MM: machine model for TSV712 ⁽⁸⁾ | 200 | |
| | MM: machine model for TSV714 ⁽⁸⁾ | 300 | |
| | CDM: charged device model except MiniSO8 ⁽⁹⁾ | 1.5 | kV |
| | CDM: charged device model for MiniSO8 ⁽⁹⁾ | 1.3 | |
| | Latchup immunity | 200 | mA |

1. All voltage values, except the differential voltage are with respect to the network ground terminal.
2. The differential voltage is a non-inverting input terminal with respect to the inverting input terminal. The TSV712 and TSV714 devices include an internal differential voltage limiter that clamps internal differential voltage at 0.5 V.
3. $V_{CC} - V_{in}$ must not exceed 6 V, V_{in} must not exceed 6 V.
4. Input current must be limited by a resistor in series with the inputs.
5. Short-circuits can cause excessive heating and destructive dissipation.
6. R_{th} are typical values.
7. Human body model: 100 pF discharged through a 1.5 kΩ resistor between two pins of the device, done for all couples of pin combinations with other pins floating.
8. Machine model: a 200 pF cap is charged to the specified voltage, then discharged directly between two pins of the device with no external series resistor (internal resistor < 5 Ω), done for all couples of pin combinations with other pins floating.
9. Charged device model: all pins plus package are charged together to the specified voltage and then discharged directly to ground.

Table 2. Operating conditions

| Symbol | Parameter | Value | Unit |
|------------|--------------------------------------|------------------------------------|------|
| V_{CC} | Supply voltage | 1.5 to 5.5 | V |
| V_{icm} | Common mode input voltage range | $V_{CC-} - 0.1$ to $V_{CC+} + 0.1$ | |
| T_{oper} | Operating free air temperature range | -40 to +125 | °C |

3 Electrical characteristics

Table 3. Electrical characteristics at $V_{CC+} = 1.8\text{ V}$ with $V_{CC-} = 0\text{ V}$, $V_{icm} = V_{CC}/2$, $T = 25\text{ °C}$, and $R_L = 10\text{ k}\Omega$ connected to $V_{CC}/2$ (unless otherwise specified)

| Symbol | Parameter | Conditions | Min. | Typ. | Max. | Unit |
|--------------------------|---|---|------|------|-------------|-------------------------|
| DC performance | | | | | | |
| V_{io} | Input offset voltage ($V_{icm} = 0\text{ V}$) | $T = 25\text{ °C}$ | | | 200 | μV |
| | | $-40\text{ °C} < T < 85\text{ °C}$ | | | 850 | |
| | | $-40\text{ °C} < T < 125\text{ °C}$ | | | 1200 | |
| $\Delta V_{io}/\Delta T$ | Input offset voltage drift | $-40\text{ °C} < T < 125\text{ °C}^{(1)}$ | | | 10 | $\mu\text{V}/\text{°C}$ |
| I_{io} | Input offset current ($V_{out} = V_{CC}/2$) | $T = 25\text{ °C}$ | | 1 | $10^{(2)}$ | pA |
| | | $-40\text{ °C} < T < 125\text{ °C}$ | | 1 | $300^{(2)}$ | |
| I_{ib} | Input bias current ($V_{out} = V_{CC}/2$) | $T = 25\text{ °C}$ | | 1 | $10^{(2)}$ | pA |
| | | $-40\text{ °C} < T < 125\text{ °C}$ | | 1 | $300^{(2)}$ | |
| CMR | Common mode rejection ratio $20 \log (\Delta V_{icm}/\Delta V_{io})$ $V_{icm} = 0\text{ V to } V_{CC}$, $V_{out} = V_{CC}/2$, $R_L > 1\text{ M}\Omega$ | $T = 25\text{ °C}$ | 69 | 88 | | dB |
| | | $-40\text{ °C} < T < 125\text{ °C}$ | 61 | | | |
| A_{vd} | Large signal voltage gain $V_{out} = 0.5\text{ V to } (V_{CC} - 0.5\text{ V})$ | $T = 25\text{ °C}$ | 95 | | | dB |
| | | $-40\text{ °C} < T < 125\text{ °C}$ | 85 | | | |
| V_{OH} | High level output voltage ($V_{OH} = V_{CC} - V_{out}$) | $T = 25\text{ °C}$ | | | 75 | mV |
| | | $-40\text{ °C} < T < 125\text{ °C}$ | | | 80 | |
| V_{OL} | Low level output voltage | $T = 25\text{ °C}$ | | | 40 | mV |
| | | $-40\text{ °C} < T < 125\text{ °C}$ | | | 60 | |
| I_{out} | I_{sink} ($V_{out} = V_{CC}$) | $T = 25\text{ °C}$ | 6 | 12 | | mA |
| | | $-40\text{ °C} < T < 125\text{ °C}$ | 4 | | | |
| | I_{source} ($V_{out} = 0\text{ V}$) | $T = 25\text{ °C}$ | 5 | 7 | | |
| | | $-40\text{ °C} < T < 125\text{ °C}$ | 3 | | | |
| I_{CC} | Supply current (per channel, $V_{out} = V_{CC}/2$, $R_L > 1\text{ M}\Omega$) | $T = 25\text{ °C}$ | | 9 | 14 | μA |
| | | $-40\text{ °C} < T < 125\text{ °C}$ | | | 16 | |

Table 3. Electrical characteristics at $V_{CC+} = 1.8\text{ V}$ with $V_{CC-} = 0\text{ V}$, $V_{icm} = V_{CC}/2$, $T = 25\text{ °C}$, and $R_L = 10\text{ k}\Omega$ connected to $V_{CC}/2$ (unless otherwise specified) (continued)

| Symbol | Parameter | Conditions | Min. | Typ. | Max. | Unit |
|-----------------------|------------------------------------|--|------|------|------|--------------------------------------|
| AC performance | | | | | | |
| GBP | Gain bandwidth product | $R_L = 10\text{ k}\Omega$, $C_L = 100\text{ pF}$ | 100 | 120 | | kHz |
| F_u | Unity gain frequency | | | 100 | | |
| Φ_m | Phase margin | | | 45 | | Degrees |
| G_m | Gain margin | | | 19 | | dB |
| SR | Slew rate ⁽³⁾ | $R_L = 10\text{ k}\Omega$, $C_L = 100\text{ pF}$, $V_{out} = 0.5\text{ V}$ to $V_{CC} - 0.5\text{ V}$ | | 0.04 | | V/ μ s |
| e_n | Equivalent input noise voltage | $f = 1\text{ kHz}$ | | 100 | | $\frac{\text{nV}}{\sqrt{\text{Hz}}}$ |
| | | $f = 10\text{ kHz}$ | | 96 | | |
| t_{init} | Initialization time ⁽⁴⁾ | $T = 25\text{ °C}$ | | | 5 | ms |
| | | $-40\text{ °C} < T < 125\text{ °C}$ | | | 60 | |

1. See [Section 4.4: Input offset voltage drift over temperature](#).
2. Guaranteed by characterization.
3. Slew rate value is calculated as the average between positive and negative slew rates.
4. Initialization time is defined as the delay after power-up to guarantee operation within specified performances. Guaranteed by design. See [Section 4.6: Initialization time](#).

Table 4. Electrical characteristics at $V_{CC+} = 3.3\text{ V}$ with $V_{CC-} = 0\text{ V}$, $V_{icm} = V_{CC}/2$, $T = 25\text{ }^\circ\text{C}$, and $R_L = 10\text{ k}\Omega$ connected to $V_{CC}/2$ (unless otherwise specified)

| Symbol | Parameter | Conditions | Min. | Typ. | Max. | Unit |
|--------------------------|---|---|------|------|-------------|---|
| DC performance | | | | | | |
| V_{io} | Input offset voltage | $T = 25\text{ }^\circ\text{C}$ | | | 200 | μV |
| | | $-40\text{ }^\circ\text{C} < T < 85\text{ }^\circ\text{C}$ | | | 850 | |
| | | $-40\text{ }^\circ\text{C} < T < 125\text{ }^\circ\text{C}$ | | | 1200 | |
| $\Delta V_{io}/\Delta T$ | Input offset voltage drift | $-40\text{ }^\circ\text{C} < T < 125\text{ }^\circ\text{C}^{(1)}$ | | | 10 | $\mu\text{V}/^\circ\text{C}$ |
| ΔV_{io} | Long-term input offset voltage drift | $T = 25\text{ }^\circ\text{C}^{(2)}$ | | 0.3 | | $\frac{\mu\text{V}}{\sqrt{\text{month}}}$ |
| I_{io} | Input offset current ($V_{out} = V_{CC}/2$) | $T = 25\text{ }^\circ\text{C}$ | | 1 | $10^{(3)}$ | pA |
| | | $-40\text{ }^\circ\text{C} < T < 125\text{ }^\circ\text{C}$ | | 1 | $300^{(3)}$ | |
| I_{ib} | Input bias current ($V_{out} = V_{CC}/2$) | $T = 25\text{ }^\circ\text{C}$ | | 1 | $10^{(3)}$ | pA |
| | | $-40\text{ }^\circ\text{C} < T < 125\text{ }^\circ\text{C}$ | | 1 | $300^{(3)}$ | |
| CMR | Common mode rejection ratio $20 \log (\Delta V_{icm}/\Delta V_{io})$ $V_{icm} = 0\text{ V to } V_{CC}$, $V_{out} = V_{CC}/2$, $R_L > 1\text{ M}\Omega$ | $T = 25\text{ }^\circ\text{C}$ | 80 | 100 | | dB |
| | | $-40\text{ }^\circ\text{C} < T < 125\text{ }^\circ\text{C}$ | 69 | | | |
| A_{vd} | Large signal voltage gain $V_{out} = 0.5\text{ V to } (V_{CC} - 0.5\text{ V})$ | $T = 25\text{ }^\circ\text{C}$ | 95 | | | |
| | | $-40\text{ }^\circ\text{C} < T < 125\text{ }^\circ\text{C}$ | 85 | | | |
| V_{OH} | High level output voltage ($V_{OH} = V_{CC} - V_{out}$) | $T = 25\text{ }^\circ\text{C}$ | | | 75 | mV |
| | | $-40\text{ }^\circ\text{C} < T < 125\text{ }^\circ\text{C}$ | | | 80 | |
| V_{OL} | Low level output voltage | $T = 25\text{ }^\circ\text{C}$ | | | 40 | mV |
| | | $-40\text{ }^\circ\text{C} < T < 125\text{ }^\circ\text{C}$ | | | 60 | |
| I_{out} | $I_{sink} (V_{out} = V_{CC})$ | $T = 25\text{ }^\circ\text{C}$ | 20 | 34 | | mA |
| | | $-40\text{ }^\circ\text{C} < T < 125\text{ }^\circ\text{C}$ | 15 | | | |
| | $I_{source} (V_{out} = 0\text{ V})$ | $T = 25\text{ }^\circ\text{C}$ | 20 | 26 | | |
| | | $-40\text{ }^\circ\text{C} < T < 125\text{ }^\circ\text{C}$ | 15 | | | |
| I_{CC} | Supply current (per channel, $V_{out} = V_{CC}/2$, $R_L > 1\text{ M}\Omega$) | $T = 25\text{ }^\circ\text{C}$ | | 9 | 14 | μA |
| | | $-40\text{ }^\circ\text{C} < T < 125\text{ }^\circ\text{C}$ | | | 16 | |

Table 4. Electrical characteristics at $V_{CC+} = 3.3\text{ V}$ with $V_{CC-} = 0\text{ V}$, $V_{icm} = V_{CC}/2$, $T = 25\text{ °C}$, and $R_L = 10\text{ k}\Omega$ connected to $V_{CC}/2$ (unless otherwise specified) (continued)

| Symbol | Parameter | Conditions | Min. | Typ. | Max. | Unit |
|-----------------------|------------------------------------|---|------|------|------|------------------------|
| AC performance | | | | | | |
| GBP | Gain bandwidth product | $R_L = 10\text{ k}\Omega$ $C_L = 100\text{ pF}$ | 100 | 120 | | kHz |
| F_u | Unity gain frequency | | | 100 | | |
| Φ_m | Phase margin | | | 45 | | Degrees |
| G_m | Gain margin | | | 19 | | dB |
| SR | Slew rate ⁽⁴⁾ | $R_L = 10\text{ k}\Omega$ $C_L = 100\text{ pF}$, $V_{out} = 0.5\text{ V to } V_{CC} - 0.5\text{ V}$ | | 0.05 | | V/ μ s |
| e_n | Equivalent input noise voltage | $f = 1\text{ kHz}$ | | 100 | | $\frac{nV}{\sqrt{Hz}}$ |
| | | $f = 10\text{ kHz}$ | | 96 | | |
| t_{init} | Initialization time ⁽⁵⁾ | $T = 25\text{ °C}$ | | | 5 | ms |
| | | $-40\text{ °C} < T < 125\text{ °C}$ | | | 50 | |

1. See [Section 4.4: Input offset voltage drift over temperature](#).
2. Typical value is based on the V_{io} drift observed after 1000h at 125 °C extrapolated to 25 °C using the Arrhenius law and assuming an activation energy of 0.7 eV. The operational amplifier is aged in follower mode configuration. See [Section 4.5: Long-term input offset voltage drift](#).
3. Guaranteed by characterization.
4. Slew rate value is calculated as the average between positive and negative slew rates.
5. Initialization time is defined as the delay after power-up which guarantees operation within specified performances. Guaranteed by design. See [Section 4.6: Initialization time](#).

Table 5. Electrical characteristics at $V_{CC+} = 5\text{ V}$ with $V_{CC-} = 0\text{ V}$, $V_{icm} = V_{CC}/2$, $T = 25\text{ }^\circ\text{C}$, and $R_L = 10\text{ k}\Omega$ connected to $V_{CC}/2$ (unless otherwise specified)

| Symbol | Parameter | Conditions | Min. | Typ. | Max. | Unit |
|--------------------------|---|---|------|------------|-------------|---|
| DC performance | | | | | | |
| V_{io} | Input offset voltage | $T = 25\text{ }^\circ\text{C}$ | | | 200 | μV |
| | | $-40\text{ }^\circ\text{C} < T < 85\text{ }^\circ\text{C}$ | | | 850 | |
| | | $-40\text{ }^\circ\text{C} < T < 125\text{ }^\circ\text{C}$ | | | 1200 | |
| $\Delta V_{io}/\Delta T$ | Input offset voltage drift | $-40\text{ }^\circ\text{C} < T < 125\text{ }^\circ\text{C}^{(1)}$ | | | 10 | $\mu\text{V}/^\circ\text{C}$ |
| ΔV_{io} | Long-term input offset voltage drift | $T = 25\text{ }^\circ\text{C}^{(2)}$ | | 0.7 | | $\frac{\mu\text{V}}{\sqrt{\text{month}}}$ |
| I_{io} | Input offset current ($V_{out} = V_{CC}/2$) | $T = 25\text{ }^\circ\text{C}$ | | 1 | $10^{(3)}$ | pA |
| | | $-40\text{ }^\circ\text{C} < T < 125\text{ }^\circ\text{C}$ | | 1 | $300^{(3)}$ | |
| I_{ib} | Input bias current ($V_{out} = V_{CC}/2$) | $T = 25\text{ }^\circ\text{C}$ | | 1 | $10^{(3)}$ | pA |
| | | $-40\text{ }^\circ\text{C} < T < 125\text{ }^\circ\text{C}$ | | 1 | $300^{(3)}$ | |
| CMR | Common mode rejection ratio $20 \log (\Delta V_{icm}/\Delta V_{io})$ $V_{icm} = 0\text{ V to } V_{CC}$, $V_{out} = V_{CC}/2$, $R_L > 1\text{ M}\Omega$ | $T = 25\text{ }^\circ\text{C}$ | 74 | 94 | | dB |
| | | $-40\text{ }^\circ\text{C} < T < 125\text{ }^\circ\text{C}$ | 73 | | | |
| SVR | Supply voltage rejection ratio $20 \log (\Delta V_{CC}/\Delta V_{io})$ $V_{CC} = 1.5\text{ to } 5.5\text{ V}$, $V_{ic} = 0\text{ V}$, $R_L > 1\text{ M}\Omega$ | $T = 25\text{ }^\circ\text{C}$ | 71 | 90 | | dB |
| | | $-40\text{ }^\circ\text{C} < T < 125\text{ }^\circ\text{C}$ | 71 | | | |
| A_{vd} | Large signal voltage gain $V_{out} = 0.5\text{ V to } (V_{CC} - 0.5\text{ V})$ | $T = 25\text{ }^\circ\text{C}$ | 95 | | | dB |
| | | $-40\text{ }^\circ\text{C} < T < 125\text{ }^\circ\text{C}$ | 85 | | | |
| EMIRR | EMI rejection ratio $\text{EMIRR} = 20 \log (V_{RFpeak}/\Delta V_{io})$ | $V_{RF} = 100\text{ mV}_{RFpeak}$, $f = 400\text{ MHz}$ | | $38^{(4)}$ | | dB |
| | | $V_{RF} = 100\text{ mV}_{RFpeak}$, $f = 900\text{ MHz}$ | | $50^{(4)}$ | | |
| | | $V_{RF} = 100\text{ mV}_{RFpeak}$, $f = 1800\text{ MHz}$ | | $60^{(4)}$ | | |
| | | $V_{RF} = 100\text{ mV}_{RFpeak}$, $f = 2400\text{ MHz}$ | | $63^{(4)}$ | | |
| V_{OH} | High level output voltage ($V_{OH} = V_{CC} - V_{out}$) | $T = 25\text{ }^\circ\text{C}$ | | | 75 | mV |
| | | $-40\text{ }^\circ\text{C} < T < 125\text{ }^\circ\text{C}$ | | | 80 | |
| V_{OL} | Low level output voltage | $T = 25\text{ }^\circ\text{C}$ | | | 40 | mV |
| | | $-40\text{ }^\circ\text{C} < T < 125\text{ }^\circ\text{C}$ | | | 60 | |
| I_{out} | $I_{sink} (V_{out} = V_{CC})$ | $T = 25\text{ }^\circ\text{C}$ | 35 | 56 | | mA |
| | | $-40\text{ }^\circ\text{C} < T < 125\text{ }^\circ\text{C}$ | 20 | | | |
| | $I_{source} (V_{out} = 0\text{ V})$ | $T = 25\text{ }^\circ\text{C}$ | 35 | 45 | | |
| | | $-40\text{ }^\circ\text{C} < T < 125\text{ }^\circ\text{C}$ | 20 | | | |
| I_{CC} | Supply current (per channel, $V_{out} = V_{CC}/2$, $R_L > 1\text{ M}\Omega$) | $T = 25\text{ }^\circ\text{C}$ | | 10 | 14 | μA |
| | | $-40\text{ }^\circ\text{C} < T < 125\text{ }^\circ\text{C}$ | | | 16 | |

Table 5. Electrical characteristics at $V_{CC+} = 5\text{ V}$ with $V_{CC-} = 0\text{ V}$, $V_{icm} = V_{CC}/2$, $T = 25\text{ }^{\circ}\text{C}$, and $R_L = 10\text{ k}\Omega$ connected to $V_{CC}/2$ (unless otherwise specified) (continued)

| Symbol | Parameter | Conditions | Min. | Typ. | Max. | Unit |
|-----------------------|--|--|------|-------|------|--------------------------------------|
| AC performance | | | | | | |
| GBP | Gain bandwidth product | $R_L = 10\text{ k}\Omega$, $C_L = 100\text{ pF}$ | 110 | 150 | | kHz |
| F_u | Unity gain frequency | | | 120 | | |
| Φ_m | Phase margin | | | 45 | | Degrees |
| G_m | Gain margin | | | 19 | | dB |
| SR | Slew rate ⁽⁵⁾ | $R_L = 10\text{ k}\Omega$, $C_L = 100\text{ pF}$, $V_{out} = 0.5\text{ V}$ to $V_{CC} - 0.5\text{ V}$ | | 0.06 | | V/ μs |
| $\int e_n$ | Low-frequency peak-to-peak input noise | Bandwidth: $f = 0.1$ to 10 Hz | | 10 | | μV_{pp} |
| e_n | Equivalent input noise voltage | $f = 1\text{ kHz}$ | | 100 | | $\frac{\text{nV}}{\sqrt{\text{Hz}}}$ |
| | | $f = 10\text{ kHz}$ | | 96 | | |
| THD+N | Total harmonic distortion + noise | $f_{in} = 1\text{ kHz}$, $A_{CL} = 1$, $R_L = 100\text{ k}\Omega$, $V_{icm} = (V_{CC} - 1\text{ V})/2$, $BW = 22\text{ kHz}$, $V_{out} = 0.5\text{ V}_{pp}$ | | 0.008 | | % |
| t_{init} | Initialization time ⁽⁶⁾ | $T = 25\text{ }^{\circ}\text{C}$ | | | 5 | ms |
| | | $-40\text{ }^{\circ}\text{C} < T < 125\text{ }^{\circ}\text{C}$ | | | 50 | |

1. See [Section 4.4: Input offset voltage drift over temperature](#).
2. Typical value is based on the V_{io} drift observed after 1000h at $125\text{ }^{\circ}\text{C}$ extrapolated to $25\text{ }^{\circ}\text{C}$ using the Arrhenius law and assuming an activation energy of 0.7 eV . The operational amplifier is aged in follower mode configuration. See [Section 4.5: Long-term input offset voltage drift](#).
3. Guaranteed by characterization.
4. Tested on SC70-5 package.
5. Slew rate value is calculated as the average between positive and negative slew rates.
6. Initialization time is defined as the delay after power-up to guarantee operation within specified performances. Guaranteed by design. See [Section 4.6: Initialization time](#).

Figure 2. Supply current vs. supply voltage at $V_{icm} = V_{CC}/2$

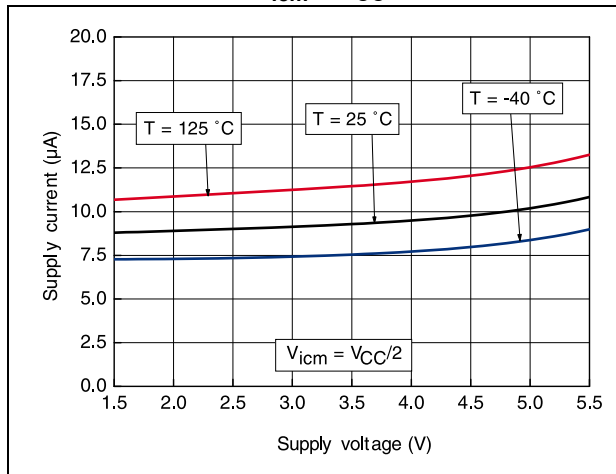

Figure 3. Input offset voltage distribution at $V_{CC} = 5 V, V_{icm} = V_{CC}/2$

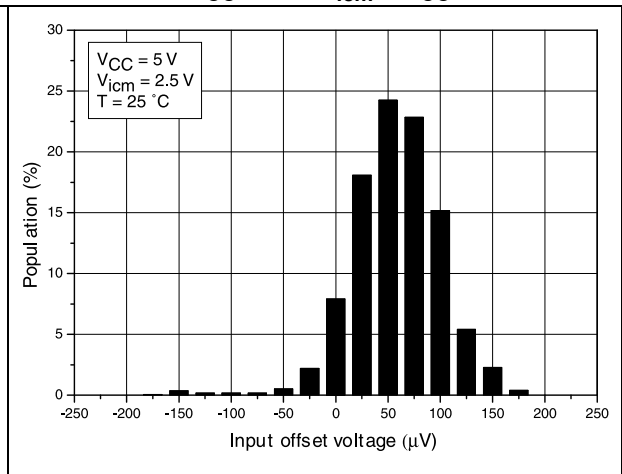

Figure 4. Input offset voltage distribution at $V_{CC} = 3.3 V, V_{icm} = V_{CC}/2$

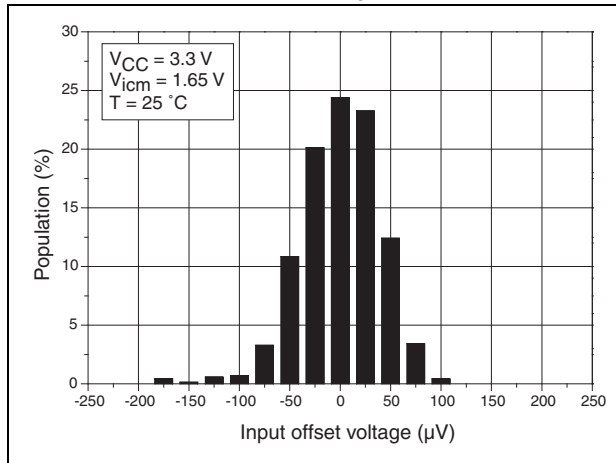

Figure 5. Input offset voltage temperature coefficient distribution

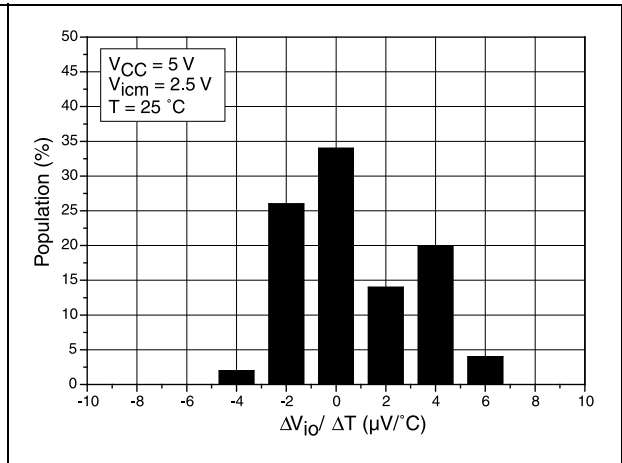

Figure 6. Input offset voltage vs. input common mode voltage

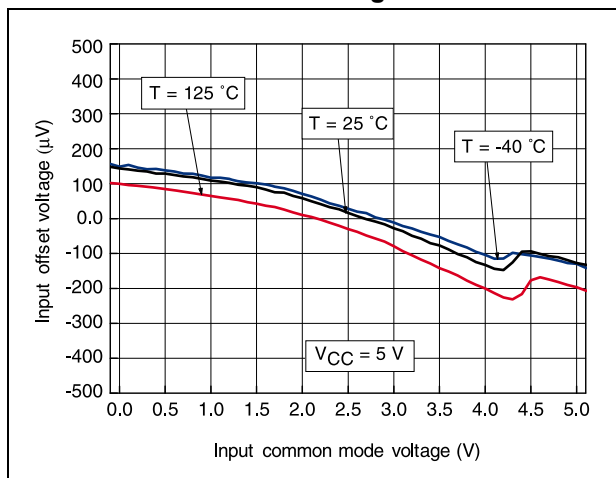

Figure 7. Input offset voltage vs. temperature

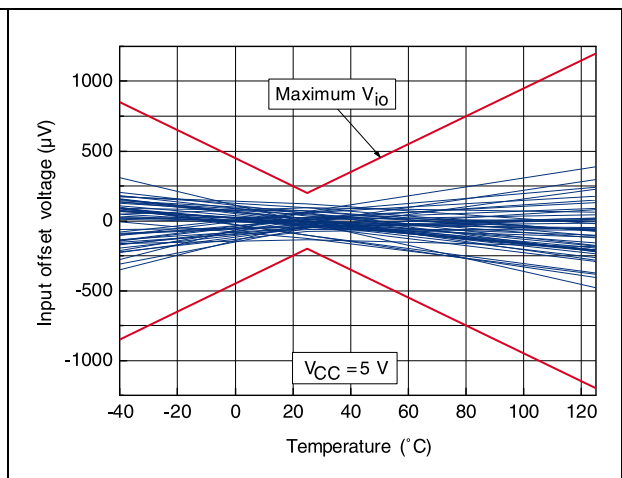

Figure 8. Output current vs. output voltage at $V_{CC} = 1.5\text{ V}$

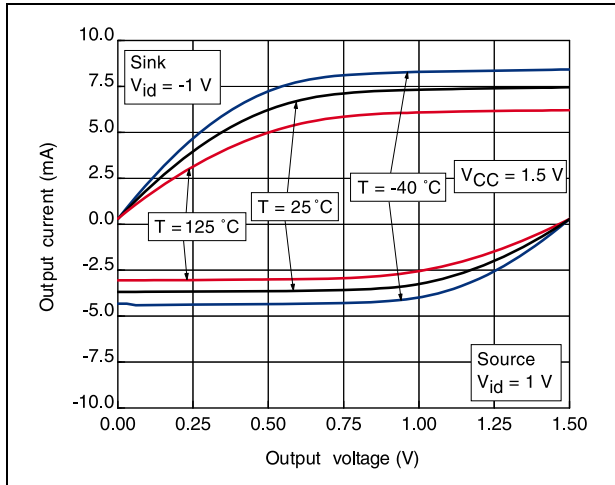

Figure 9. Output current vs. output voltage at $V_{CC} = 5\text{ V}$

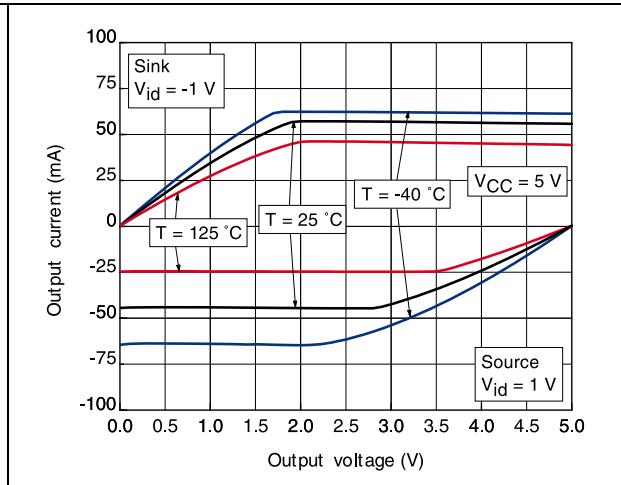

Figure 10. Output current vs. supply voltage

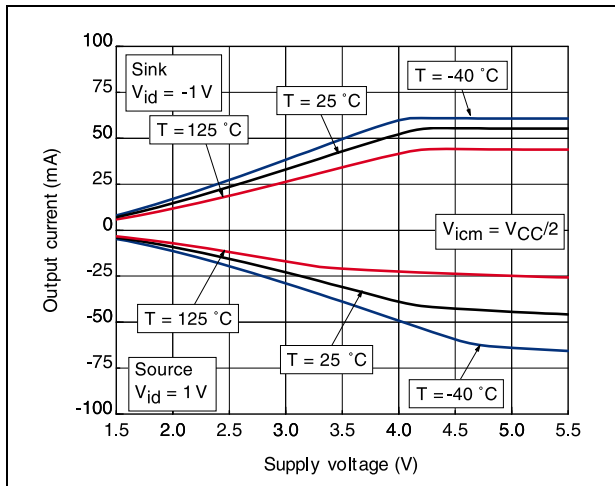

Figure 11. Bode diagram at $V_{CC} = 1.5\text{ V}$

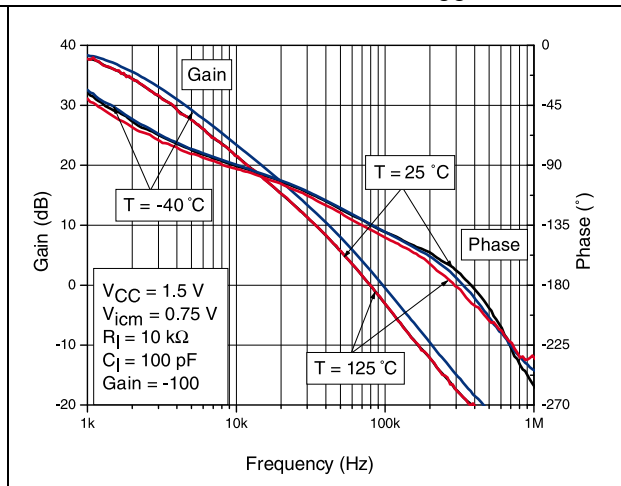

Figure 12. Bode diagram at $V_{CC} = 5\text{ V}$

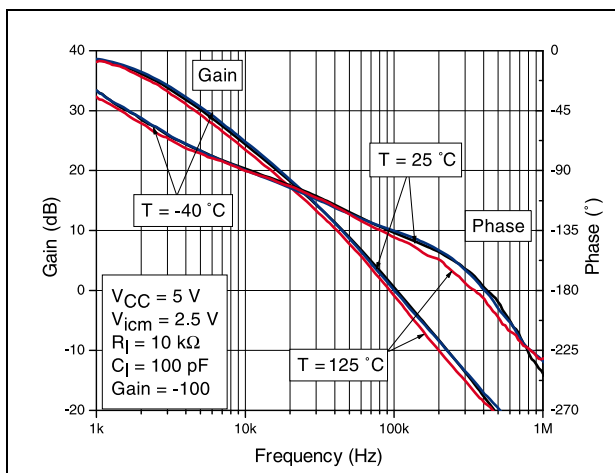

Figure 13. Closed-loop gain diagram vs. capacitive load

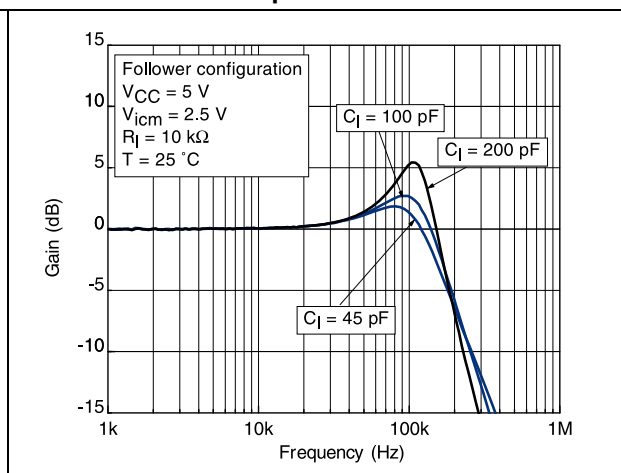

Figure 14. Positive slew rate

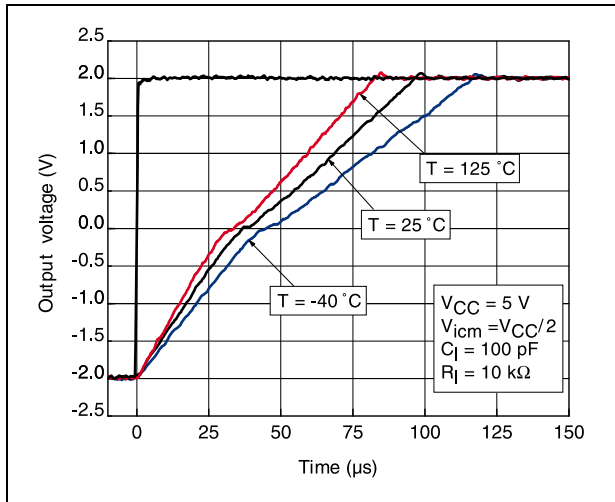

Figure 15. Negative slew rate

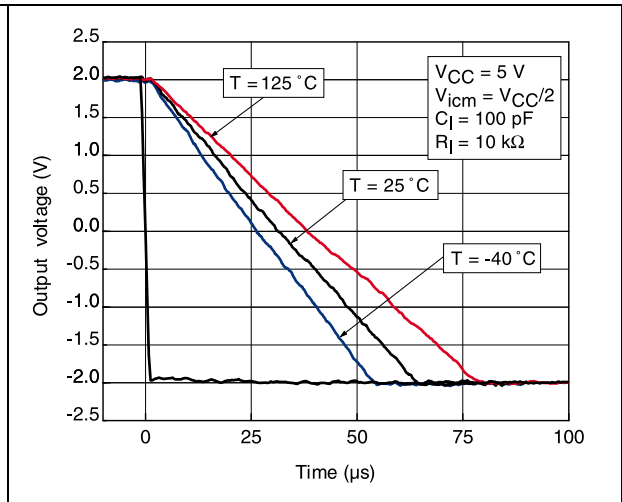

Figure 16. Slew rate vs. supply voltage

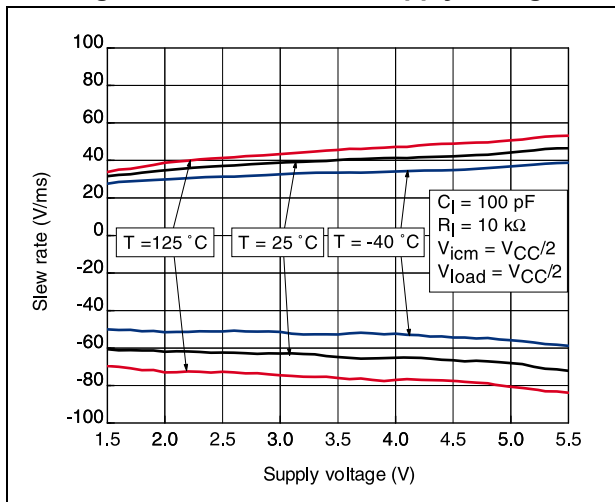

Figure 17. Noise vs. frequency

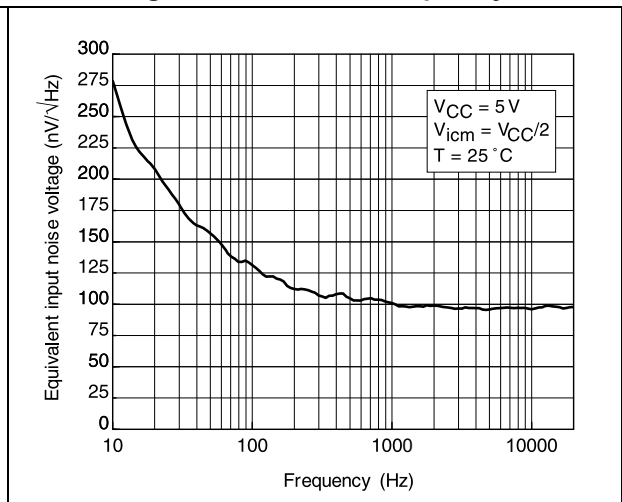

Figure 18. 0.1 Hz to 10 Hz noise

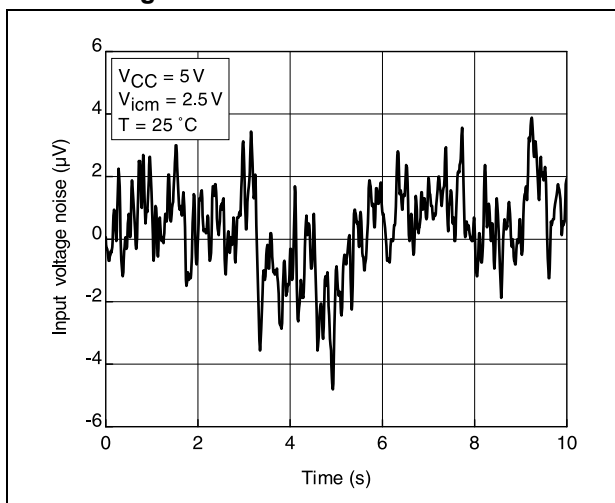

Figure 19. THD+N vs. frequency

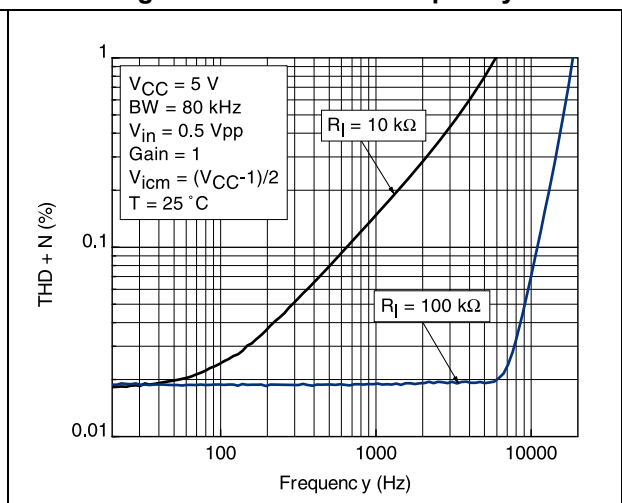

Figure 20. THD+N vs. output voltage

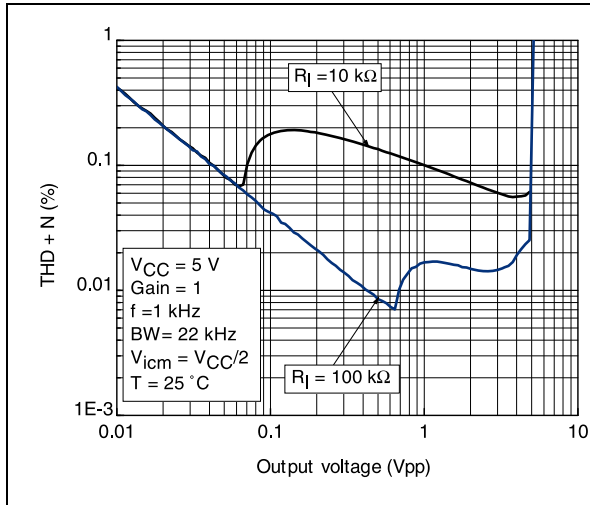
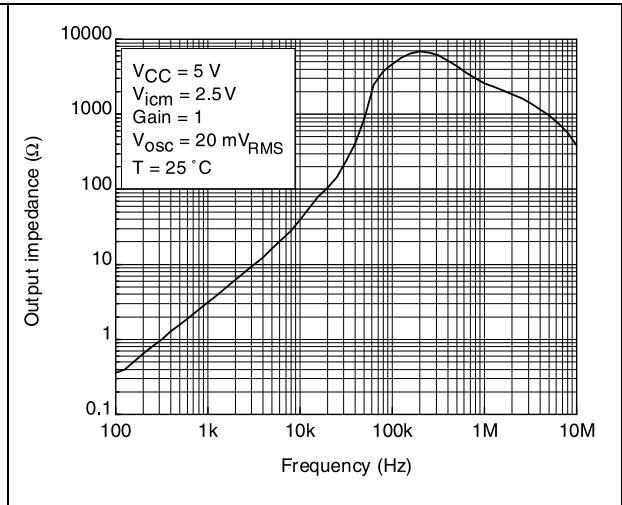

Figure 21. Output impedance vs. frequency in closed-loop configuration



4 Application information

4.1 Operating voltages

The TSV71x series of devices can operate from 1.5 V to 5.5 V. The parameters are fully specified for 1.8 V, 3.3 V, and 5 V power supplies. However, they are very stable in the full V_{CC} range and several characterization curves show TSV71x device characteristics at 1.5 V. In addition, the main specifications are guaranteed in the extended temperature range from $-40\text{ }^{\circ}\text{C}$ to $+125\text{ }^{\circ}\text{C}$.

4.2 Rail-to-rail input

The TSV711, TSV712, and TSV714 devices have a rail-to-rail input, and the input common mode range is extended from $V_{CC-} - 0.1\text{ V}$ to $V_{CC+} + 0.1\text{ V}$.

4.3 Rail-to-rail output

The output levels of the TSV71x operational amplifiers can go close to the rails: to a maximum of 40 mV below the upper rail and to a maximum of 75 mV above the lower rail when a 10 k Ω resistive load is connected to $V_{CC}/2$.

4.4 Input offset voltage drift over temperature

The maximum input voltage drift over the temperature variation is defined as the offset variation related to offset value measured at $25\text{ }^{\circ}\text{C}$. The operational amplifier is one of the main circuits of the signal conditioning chain, and the amplifier input offset is a major contributor to the chain accuracy. The signal chain accuracy at $25\text{ }^{\circ}\text{C}$ can be compensated during production at application level. The maximum input voltage drift over temperature enables the system designer to anticipate the effect of temperature variations.

The maximum input voltage drift over temperature is computed using [Equation 1](#).

Equation 1

$$\frac{\Delta V_{io}}{\Delta T} = \max \left| \frac{V_{io}(T) - V_{io}(25^{\circ}\text{C})}{T - 25^{\circ}\text{C}} \right|$$

with $T = -40\text{ }^{\circ}\text{C}$ and $125\text{ }^{\circ}\text{C}$.

The datasheet maximum value is guaranteed by a measurement on a representative sample size ensuring a C_{pk} (process capability index) greater than 1.33.

4.5 Long-term input offset voltage drift

To evaluate product reliability, two types of stress acceleration are used:

- Voltage acceleration, by changing the applied voltage
- Temperature acceleration, by changing the die temperature (below the maximum junction temperature allowed by the technology) with the ambient temperature.

The voltage acceleration has been defined based on JEDEC results, and is defined using [Equation 2](#).

Equation 2

$$A_{FV} = e^{\beta \cdot (V_S - V_U)}$$

Where:

A_{FV} is the voltage acceleration factor

β is the voltage acceleration constant in $1/V$, constant technology parameter ($\beta = 1$)

V_S is the stress voltage used for the accelerated test

V_U is the voltage used for the application

The temperature acceleration is driven by the Arrhenius model, and is defined in [Equation 3](#).

Equation 3

$$A_{FT} = e^{\frac{E_a}{k} \cdot \left(\frac{1}{T_U} - \frac{1}{T_S} \right)}$$

Where:

A_{FT} is the temperature acceleration factor

E_a is the activation energy of the technology based on the failure rate

k is the Boltzmann constant ($8.6173 \times 10^{-5} \text{ eV.K}^{-1}$)

T_U is the temperature of the die when V_U is used (K)

T_S is the temperature of the die under temperature stress (K)

The final acceleration factor, A_F , is the multiplication of the voltage acceleration factor and the temperature acceleration factor ([Equation 4](#)).

Equation 4

$$A_F = A_{FT} \times A_{FV}$$

A_F is calculated using the temperature and voltage defined in the mission profile of the product. The A_F value can then be used in [Equation 5](#) to calculate the number of months of use equivalent to 1000 hours of reliable stress duration.

Equation 5

$$\text{Months} = A_F \times 1000 \text{ h} \times 12 \text{ months} / (24 \text{ h} \times 365.25 \text{ days})$$

To evaluate the op-amp reliability, a follower stress condition is used where V_{CC} is defined as a function of the maximum operating voltage and the absolute maximum rating (as recommended by JEDEC rules).

The V_{io} drift (in μV) of the product after 1000 h of stress is tracked with parameters at different measurement conditions (see [Equation 6](#)).

Equation 6

$$V_{CC} = \max V_{op} \text{ with } V_{icm} = V_{CC} / 2$$

The long term drift parameter (ΔV_{io}), estimating the reliability performance of the product, is obtained using the ratio of the V_{io} (input offset voltage value) drift over the square root of the calculated number of months ([Equation 7](#)).

Equation 7

$$\Delta V_{io} = \frac{V_{io} \text{ drift}}{\sqrt{(\text{months})}}$$

where V_{io} drift is the measured drift value in the specified test conditions after 1000 h stress duration.

4.6 Initialization time

The TSV71x series of devices use a proprietary trimming topology that is initiated at each device power-up and allows excellent V_{io} performance to be achieved. The initialization time is defined as the delay after power-up which guarantees operation within specified performances. During this period, the current consumption (I_{CC}) and the input offset voltage (V_{io}) can be different to the typical ones.

Figure 22. Initialization phase

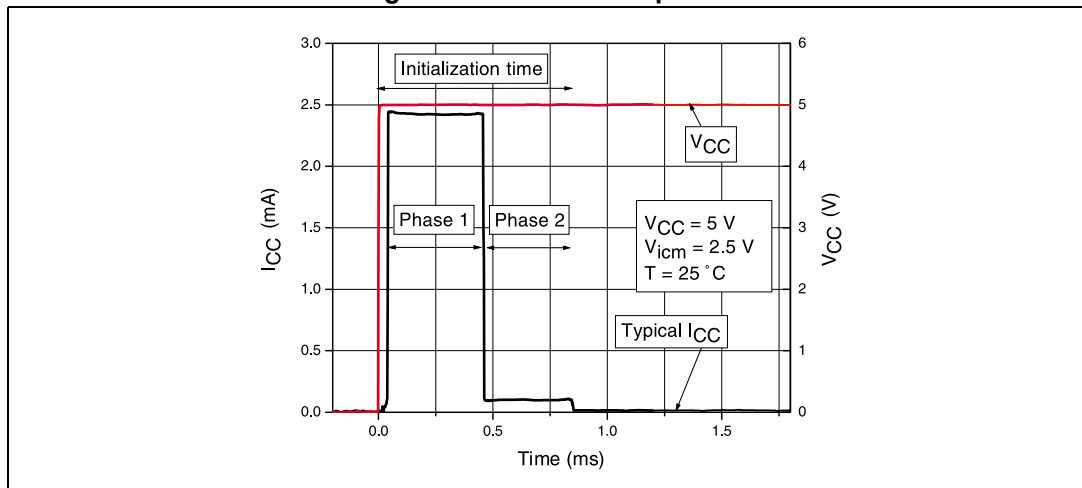

The initialization time is V_{CC} and temperature dependent. Table 6 sums up the measurement results for different supply voltages and for temperatures varying from $-40\text{ }^{\circ}\text{C}$ to $125\text{ }^{\circ}\text{C}$.

Table 6. Initialization time measurement results

| V_{CC} (V) | Temperature: $-40\text{ }^{\circ}\text{C}$ | | Temperature: $25\text{ }^{\circ}\text{C}$ | | Temperature: $125\text{ }^{\circ}\text{C}$ | |
|--------------|--|-----------------------|---|-----------------------|--|-----------------------|
| | T_{init} (ms) | I_{CC} phase 1 (mA) | T_{init} (ms) | I_{CC} phase 1 (mA) | T_{init} (ms) | I_{CC} phase 1 (mA) |
| 1.8 | 37 | 0.33 | 3.2 | 0.40 | 0.35 | 0.46 |
| 3.3 | 2.9 | 1.4 | 0.95 | 1.3 | 0.34 | 1.2 |
| 5 | 2.4 | 3.2 | 0.85 | 2.4 | 0.31 | 2.9 |

4.7 PCB layouts

For correct operation, it is advised to add a 10 nF decoupling capacitors as close as possible to the power supply pins.

4.8 Macromodel

Accurate macromodels of the TSV71x devices are available on the STMicroelectronics' website at www.st.com. These model are a trade-off between accuracy and complexity (that is, time simulation) of the TSV71x operational amplifiers. They emulate the nominal performance of a typical device within the specified operating conditions mentioned in the datasheet. They also help to validate a design approach and to select the right operational amplifier, *but they do not replace on-board measurements*.

5 Package information

In order to meet environmental requirements, ST offers these devices in different grades of ECOPACK[®] packages, depending on their level of environmental compliance. ECOPACK[®] specifications, grade definitions and product status are available at: www.st.com. ECOPACK[®] is an ST trademark.

5.1 SC70-5 package information

Figure 23. SC70-5 package mechanical drawing

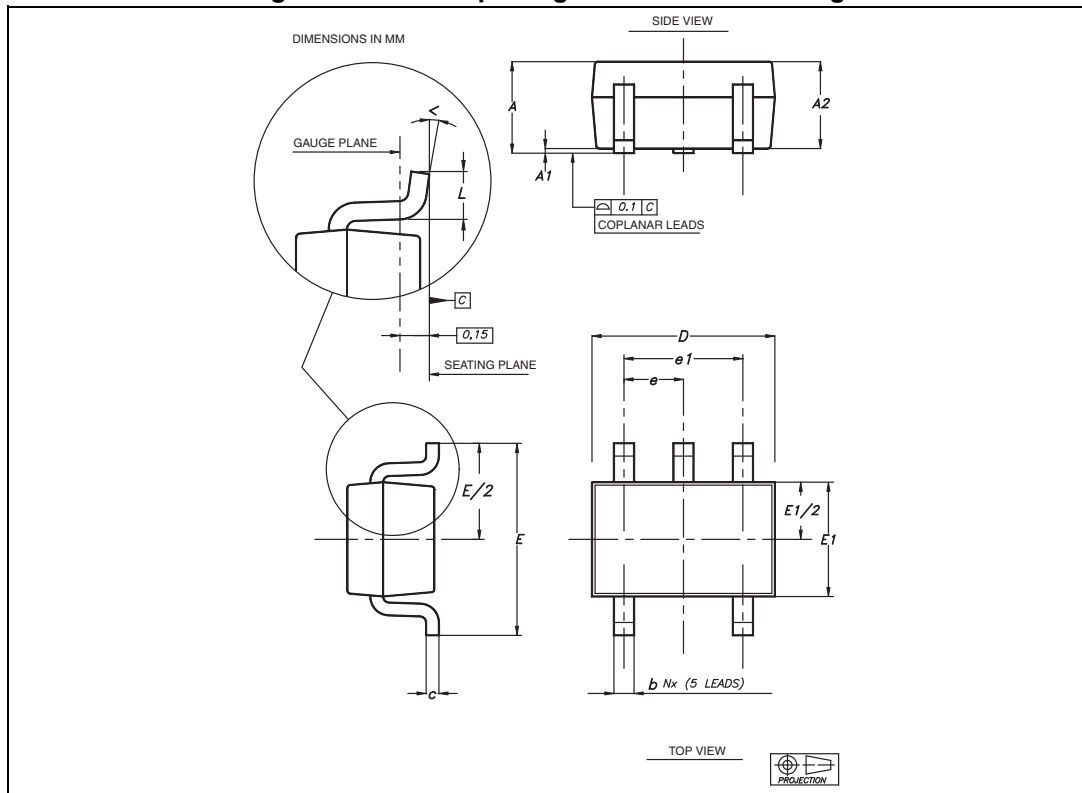

Table 7. SC70-5 package mechanical data

| Symbol | Dimensions | | | | | |
|--------|-------------|------|------|--------|-------|-------|
| | Millimeters | | | Inches | | |
| | Min. | Typ. | Max. | Min. | Typ. | Max. |
| A | 0.80 | | 1.10 | 0.032 | | 0.043 |
| A1 | 0 | | 0.10 | | | 0.004 |
| A2 | 0.80 | 0.90 | 1.00 | 0.032 | 0.035 | 0.039 |
| b | 0.15 | | 0.30 | 0.006 | | 0.012 |
| c | 0.10 | | 0.22 | 0.004 | | 0.009 |
| D | 1.80 | 2.00 | 2.20 | 0.071 | 0.079 | 0.087 |
| E | 1.80 | 2.10 | 2.40 | 0.071 | 0.083 | 0.094 |
| E1 | 1.15 | 1.25 | 1.35 | 0.045 | 0.049 | 0.053 |
| e | | 0.65 | | | 0.025 | |
| e1 | | 1.30 | | | 0.051 | |
| L | 0.26 | 0.36 | 0.46 | 0.010 | 0.014 | 0.018 |
| < | 0° | | 8° | 0° | | 8° |

5.2 DFN8 2x2 package information

Figure 24. DFN8 2x2 package mechanical drawing

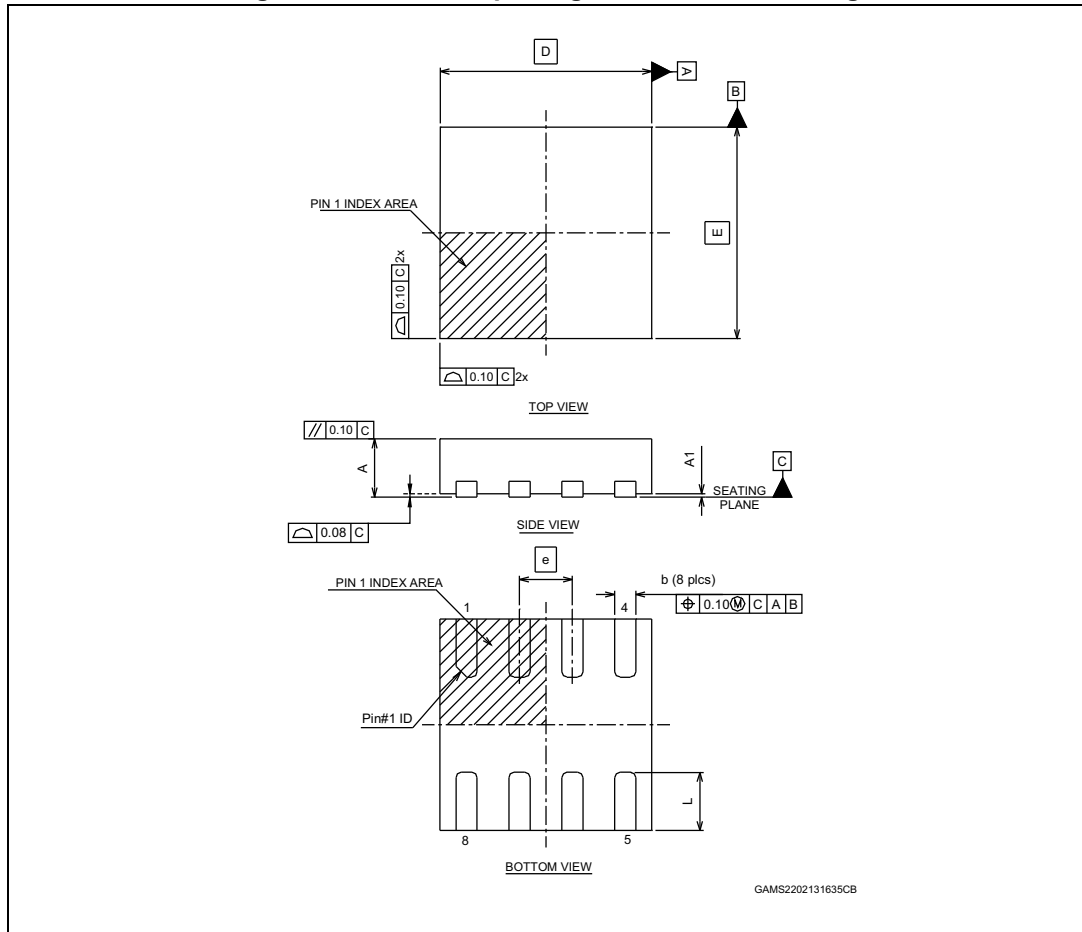

Table 8. DFN8 2x2 package mechanical data

| Ref. | Dimensions | | | | | |
|------|-------------|------|------|--------|-------|-------|
| | Millimeters | | | Inches | | |
| | Min. | Typ. | Max. | Min. | Typ. | Max. |
| A | 0.70 | 0.75 | 0.80 | 0.028 | 0.030 | 0.031 |
| A1 | 0.00 | 0.02 | 0.05 | 0.000 | 0.001 | 0.002 |
| b | 0.15 | 0.20 | 0.25 | 0.006 | 0.008 | 0.010 |
| D | | 2.00 | | | 0.079 | |
| E | | 2.00 | | | 0.079 | |
| e | | 0.50 | | | 0.020 | |
| L | 0.045 | 0.55 | 0.65 | 0.018 | 0.022 | 0.026 |
| N | 8 | | | 8 | | |

5.3 MiniSO-8 package information

Figure 25. MiniSO-8 package mechanical drawing

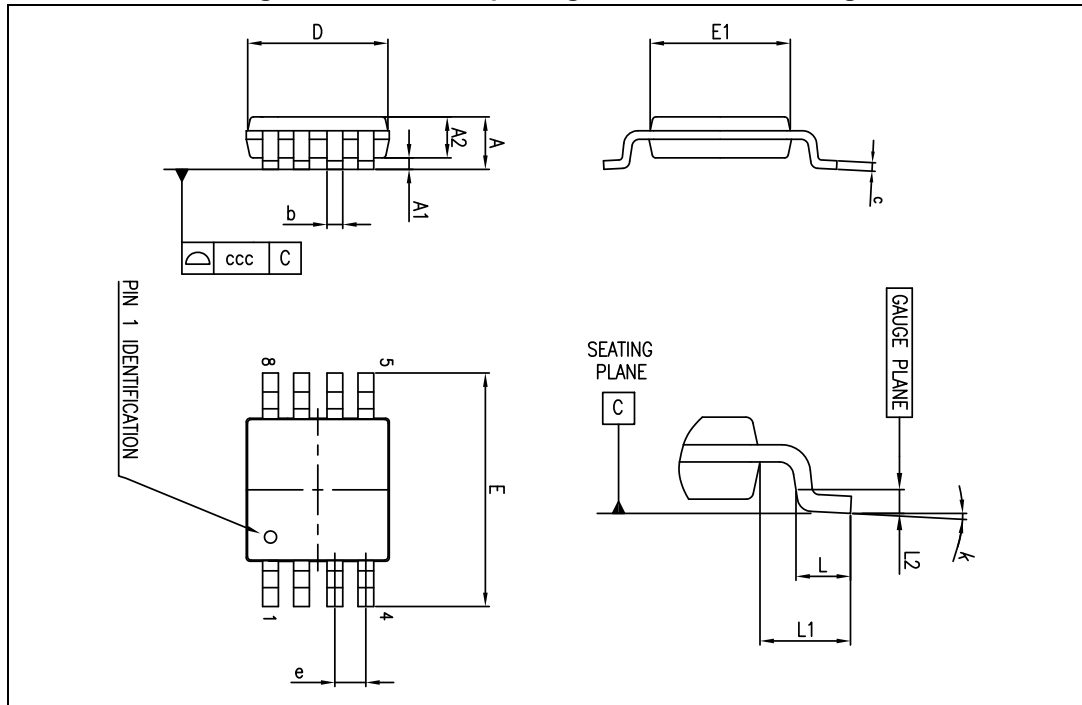

Table 9. MiniSO-8 package mechanical data

| Ref. | Dimensions | | | | | |
|------|-------------|------|------|--------|-------|-------|
| | Millimeters | | | Inches | | |
| | Min. | Typ. | Max. | Min. | Typ. | Max. |
| A | | | 1.1 | | | 0.043 |
| A1 | 0 | | 0.15 | 0 | | 0.006 |
| A2 | 0.75 | 0.85 | 0.95 | 0.030 | 0.033 | 0.037 |
| b | 0.22 | | 0.40 | 0.009 | | 0.016 |
| c | 0.08 | | 0.23 | 0.003 | | 0.009 |
| D | 2.80 | 3.00 | 3.20 | 0.11 | 0.118 | 0.126 |
| E | 4.65 | 4.90 | 5.15 | 0.183 | 0.193 | 0.203 |
| E1 | 2.80 | 3.00 | 3.10 | 0.11 | 0.118 | 0.122 |
| e | | 0.65 | | | 0.026 | |
| L | 0.40 | 0.60 | 0.80 | 0.016 | 0.024 | 0.031 |
| L1 | | 0.95 | | | 0.037 | |
| L2 | | 0.25 | | | 0.010 | |
| k | 0° | | 8° | 0° | | 8° |
| ccc | | | 0.10 | | | 0.004 |

5.4 QFN16 3x3 package information

Figure 26. QFN16 3x3 package mechanical drawing

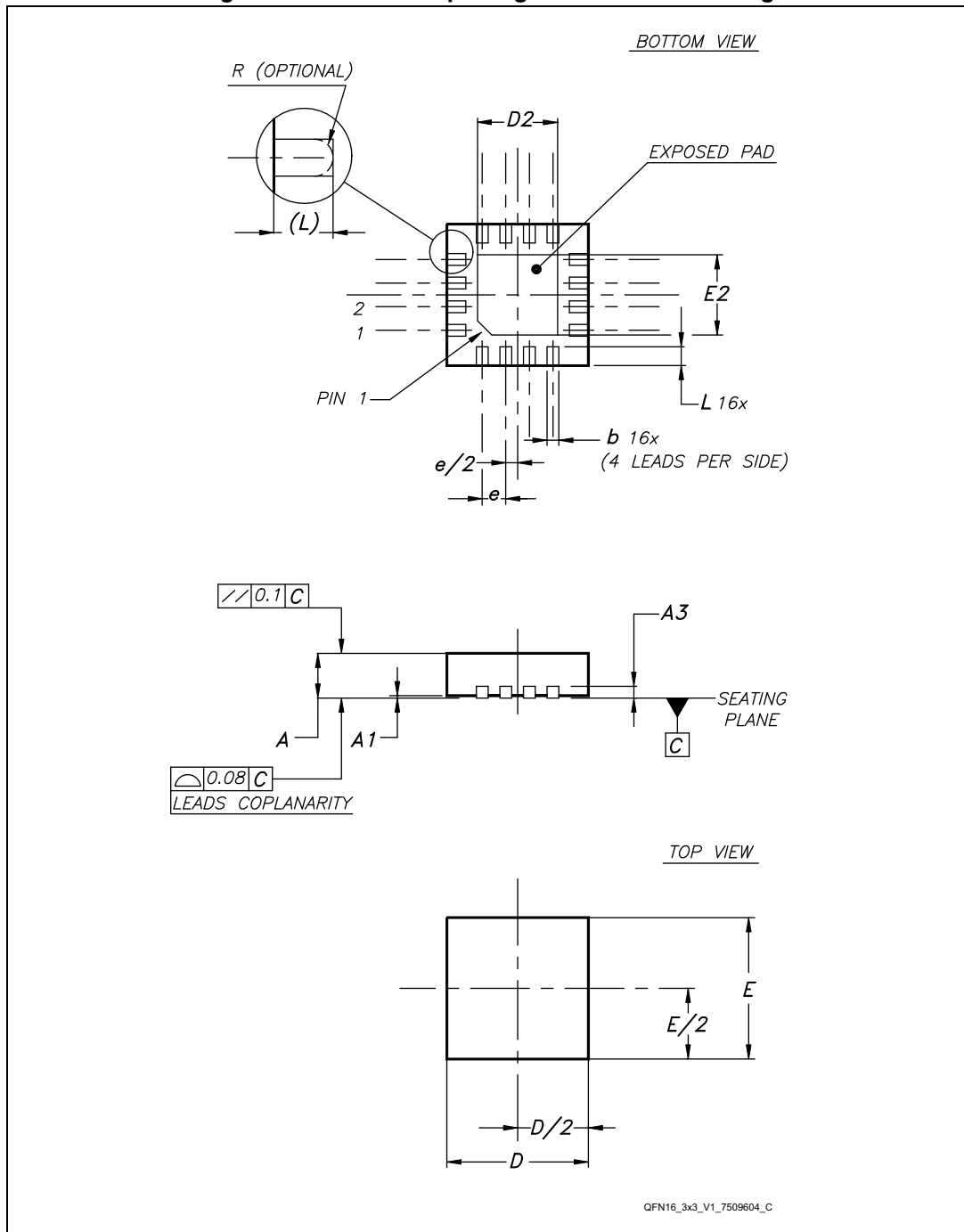
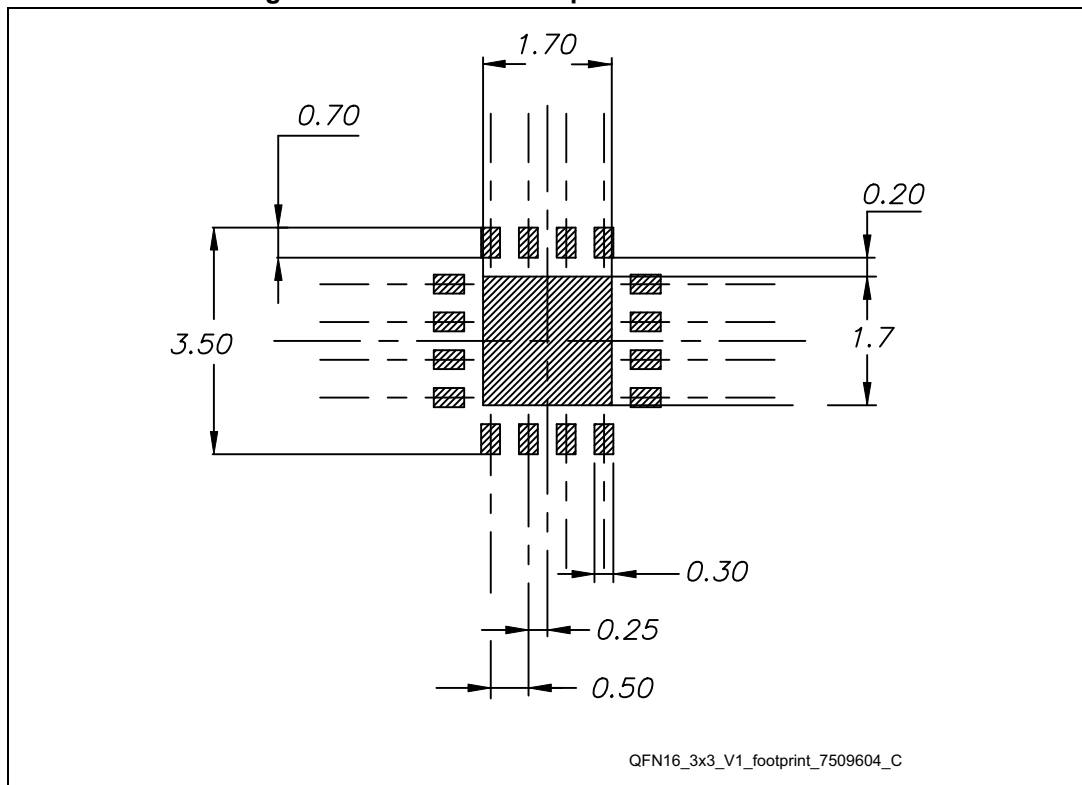

Table 10. QFN16 3x3 mm package mechanical data (pitch 0.5 mm)

| Ref. | Dimensions | | | | | |
|------|-------------|------|------|--------|-------|-------|
| | Millimeters | | | Inches | | |
| | Min. | Typ. | Max. | Min. | Typ. | Max. |
| A | 0.80 | 0.90 | 1.00 | 0.031 | 0.035 | 0.039 |
| A1 | 0 | | 0.05 | 0 | | 0.002 |
| A3 | | 0.20 | | | 0.008 | |
| b | 0.18 | | 0.30 | 0.007 | | 0.012 |
| D | 2.90 | 3.00 | 3.10 | 0.114 | 0.118 | 0.122 |
| D2 | 1.50 | | 1.80 | 0.059 | | 0.071 |
| E | 2.90 | 3.00 | 3.10 | 0.114 | 0.118 | 0.122 |
| E2 | 1.50 | | 1.80 | 0.059 | | 0.071 |
| e | | 0.50 | | | 0.020 | |
| L | 0.30 | | 0.50 | 0.012 | | 0.020 |

Figure 27. QFN16 3x3 footprint recommendation



5.5 TSSOP14 package information

Figure 28. TSSOP14 package mechanical drawing

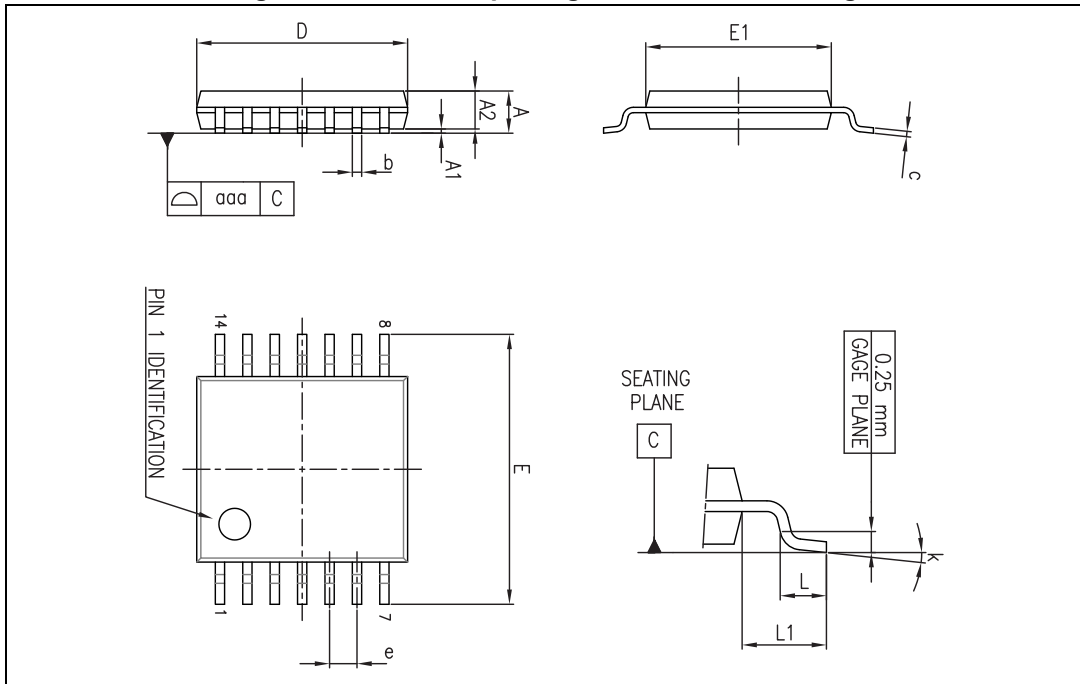

Table 11. TSSOP14 package mechanical data

| Ref. | Dimensions | | | | | |
|------|-------------|------|------|--------|--------|--------|
| | Millimeters | | | Inches | | |
| | Min. | Typ. | Max. | Min. | Typ. | Max. |
| A | | | 1.20 | | | 0.047 |
| A1 | 0.05 | | 0.15 | 0.002 | 0.004 | 0.006 |
| A2 | 0.80 | 1.00 | 1.05 | 0.031 | 0.039 | 0.041 |
| b | 0.19 | | 0.30 | 0.007 | | 0.012 |
| c | 0.09 | | 0.20 | 0.004 | | 0.0089 |
| D | 4.90 | 5.00 | 5.10 | 0.193 | 0.197 | 0.201 |
| E | 6.20 | 6.40 | 6.60 | 0.244 | 0.252 | 0.260 |
| E1 | 4.30 | 4.40 | 4.50 | 0.169 | 0.173 | 0.176 |
| e | | 0.65 | | | 0.0256 | |
| L | 0.45 | 0.60 | 0.75 | 0.018 | 0.024 | 0.030 |
| L1 | | 1.00 | | | 0.039 | |
| k | 0° | | 8° | 0° | | 8° |
| aaa | | | 0.10 | | | 0.004 |

6 Ordering information

Table 12. Order codes

| Order code | Temperature range | Package | Packaging | Marking |
|------------|-------------------|-----------|---------------|----------|
| TSV711ICT | -40° C to +125° C | SC70-5 | Tape and reel | K1W |
| TSV712IQ2T | | DFN8 2x2 | | K1W |
| TSV712IST | | MiniSO8 | | V712 |
| TSV714IQ4T | | QFN16 3x3 | | K1W |
| TSV714IPT | | TSSOP14 | | TSV714IP |

7 Revision history

Table 13. Document revision history

| Date | Revision | Changes |
|-------------|----------|---|
| 26-Sep-2012 | 1 | Initial internal release |
| 26-Mar-2013 | 2 | Initial public release. Datasheet updated for two new products: TSV712 and TSV714. Four new packages added: DFN8 2x2, MiniSO-8, QFN16 3x3, and TSSOP14. Updated Table 3 , Table 4 , and Table 5 . Section 4: Application information : re-written |

Please Read Carefully:

Information in this document is provided solely in connection with ST products. STMicroelectronics NV and its subsidiaries ("ST") reserve the right to make changes, corrections, modifications or improvements, to this document, and the products and services described herein at any time, without notice.

All ST products are sold pursuant to ST's terms and conditions of sale.

Purchasers are solely responsible for the choice, selection and use of the ST products and services described herein, and ST assumes no liability whatsoever relating to the choice, selection or use of the ST products and services described herein.

No license, express or implied, by estoppel or otherwise, to any intellectual property rights is granted under this document. If any part of this document refers to any third party products or services it shall not be deemed a license grant by ST for the use of such third party products or services, or any intellectual property contained therein or considered as a warranty covering the use in any manner whatsoever of such third party products or services or any intellectual property contained therein.

UNLESS OTHERWISE SET FORTH IN ST'S TERMS AND CONDITIONS OF SALE ST DISCLAIMS ANY EXPRESS OR IMPLIED WARRANTY WITH RESPECT TO THE USE AND/OR SALE OF ST PRODUCTS INCLUDING WITHOUT LIMITATION IMPLIED WARRANTIES OF MERCHANTABILITY, FITNESS FOR A PARTICULAR PURPOSE (AND THEIR EQUIVALENTS UNDER THE LAWS OF ANY JURISDICTION), OR INFRINGEMENT OF ANY PATENT, COPYRIGHT OR OTHER INTELLECTUAL PROPERTY RIGHT.

ST PRODUCTS ARE NOT AUTHORIZED FOR USE IN WEAPONS. NOR ARE ST PRODUCTS DESIGNED OR AUTHORIZED FOR USE IN: (A) SAFETY CRITICAL APPLICATIONS SUCH AS LIFE SUPPORTING, ACTIVE IMPLANTED DEVICES OR SYSTEMS WITH PRODUCT FUNCTIONAL SAFETY REQUIREMENTS; (B) AERONAUTIC APPLICATIONS; (C) AUTOMOTIVE APPLICATIONS OR ENVIRONMENTS, AND/OR (D) AEROSPACE APPLICATIONS OR ENVIRONMENTS. WHERE ST PRODUCTS ARE NOT DESIGNED FOR SUCH USE, THE PURCHASER SHALL USE PRODUCTS AT PURCHASER'S SOLE RISK, EVEN IF ST HAS BEEN INFORMED IN WRITING OF SUCH USAGE, UNLESS A PRODUCT IS EXPRESSLY DESIGNATED BY ST AS BEING INTENDED FOR "AUTOMOTIVE, AUTOMOTIVE SAFETY OR MEDICAL" INDUSTRY DOMAINS ACCORDING TO ST PRODUCT DESIGN SPECIFICATIONS. PRODUCTS FORMALLY ESCC, QML OR JAN QUALIFIED ARE DEEMED SUITABLE FOR USE IN AEROSPACE BY THE CORRESPONDING GOVERNMENTAL AGENCY.

Resale of ST products with provisions different from the statements and/or technical features set forth in this document shall immediately void any warranty granted by ST for the ST product or service described herein and shall not create or extend in any manner whatsoever, any liability of ST.

ST and the ST logo are trademarks or registered trademarks of ST in various countries.

Information in this document supersedes and replaces all information previously supplied.

The ST logo is a registered trademark of STMicroelectronics. All other names are the property of their respective owners.

© 2013 STMicroelectronics - All rights reserved

STMicroelectronics group of companies

Australia - Belgium - Brazil - Canada - China - Czech Republic - Finland - France - Germany - Hong Kong - India - Israel - Italy - Japan - Malaysia - Malta - Morocco - Philippines - Singapore - Spain - Sweden - Switzerland - United Kingdom - United States of America

www.st.com





**Стандарт
Электрон
Связь**

Мы молодая и активно развивающаяся компания в области поставок электронных компонентов. Мы поставляем электронные компоненты отечественного и импортного производства напрямую от производителей и с крупнейших складов мира.

Благодаря сотрудничеству с мировыми поставщиками мы осуществляем комплексные и плановые поставки широчайшего спектра электронных компонентов.

Собственная эффективная логистика и склад в обеспечивает надежную поставку продукции в точно указанные сроки по всей России.

Мы осуществляем техническую поддержку нашим клиентам и предпродажную проверку качества продукции. На все поставляемые продукты мы предоставляем гарантию .

Осуществляем поставки продукции под контролем ВП МО РФ на предприятия военно-промышленного комплекса России , а также работаем в рамках 275 ФЗ с открытием отдельных счетов в уполномоченном банке. Система менеджмента качества компании соответствует требованиям ГОСТ ISO 9001.

Минимальные сроки поставки, гибкие цены, неограниченный ассортимент и индивидуальный подход к клиентам являются основой для выстраивания долгосрочного и эффективного сотрудничества с предприятиями радиоэлектронной промышленности, предприятиями ВПК и научно-исследовательскими институтами России.

С нами вы становитесь еще успешнее!

Наши контакты:

Телефон: +7 812 627 14 35

Электронная почта: sales@st-electron.ru

Адрес: 198099, Санкт-Петербург,
Промышленная ул, дом № 19, литера Н,
помещение 100-Н Офис 331