

40A, 45V - 60V Trench Schottky Rectifiers

FEATURES

- Patented Trench Schottky technology
- Excellent high temperature stability
- Low forward voltage
- Low power loss/ High efficiency
- High forward surge capability
- Compliant to RoHS directive 2011/65/EU and in accordance to WEEE 2002/96/EC
- Halogen-free according to IEC 61249-2-21

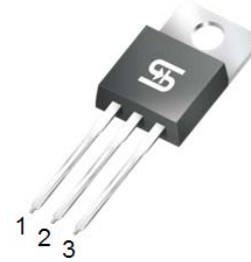

TO-220AB

TYPICAL APPLICATIONS

Trench Schottky barrier rectifier is designed for high frequency switched mode power supplies such as adapters, lighting and DC/DC converters.



MECHANICAL DATA

Case: TO-220AB

Molding compound: meets UL 94 V-0 flammability rating

Packing code with suffix "G" means green compound (halogen-free)

Terminal: Matte tin plated leads, solderable per JESD22-B102

Meet JESD 201 class 1A whisker test

Polarity: As marked

Mounting torque: 0.56 Nm max.

Weight: 1.88 g (approximately)

MAXIMUM RATINGS AND ELECTRICAL CHARACTERISTICS (T _A = 25°C unless otherwise noted)								
PARAMETER			SYMBOL	TST40L45CW	TST40L60CW	UNIT		
Maximum repetitive peak reverse voltage			V _{RRM}	45	60	V		
Maximum average forward rectified current	per device		I _{F(AV)}	40		A		
	per diode			20				
Peak forward surge current, 8.3 ms single half sine-wave superimposed on rated load per diode			I _{FSM}	250		A		
Voltage rate of change (Rated V _R)			dV/dt	10000		V/μs		
				TYP.	MAX.	TYP.	MAX.	
Instantaneous forward voltage per diode (Note1)	I _F = 20A	T _J = 25°C	V _F	0.49	0.59	0.53	0.63	V
	I _F = 20A	T _J = 125°C		0.43	0.53	0.47	0.57	
Maximum instantaneous reverse current per diode at rated reverse voltage	T _J = 25°C		I _R	500		μA		
	T _J = 125°C			100			mA	
Typical thermal resistance per diode			R _{θJC}	3		°C/W		
			R _{θJL}	3				
Operating junction temperature range			T _J	- 55 to +150		°C		
Storage temperature range			T _{STG}	- 55 to +150		°C		

Note 1: Pulse test with pulse width = 300μs, 1% duty cycle

ORDERING INFORMATION

PART NO.	PACKING CODE	PACKING CODE SUFFIX	PACKAGE	PACKING
TST40LXXCW (Note 1, 2)	C0	G	TO-220AB	50 / Tube

Note 1: "XX" defines voltage from 45V (TST40L45CW) to 60V (TST40L60CW)

Note 2: Whole series with green compound

EXAMPLE

EXAMPLE PART NO.	PART NO.	PACKING CODE	PACKING CODE SUFFIX	DESCRIPTION
TST40L60CW C0G	TST40L60CW	C0	G	Green compound

RATINGS AND CHARACTERISTICS CURVES

($T_A = 25^\circ\text{C}$ unless otherwise noted)

FIG.1 FORWARD CURRENT DERATING CURVE

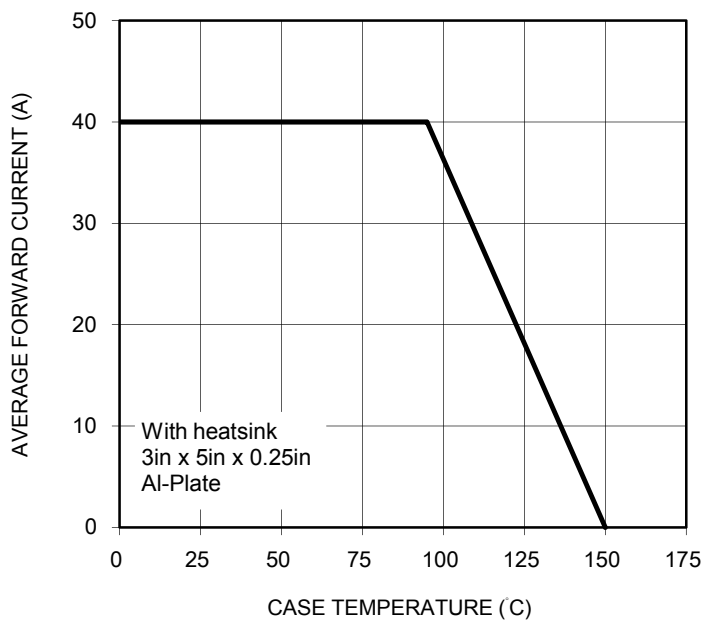

FIG.2 TYPICAL FORWARD CHARACTERISTICS

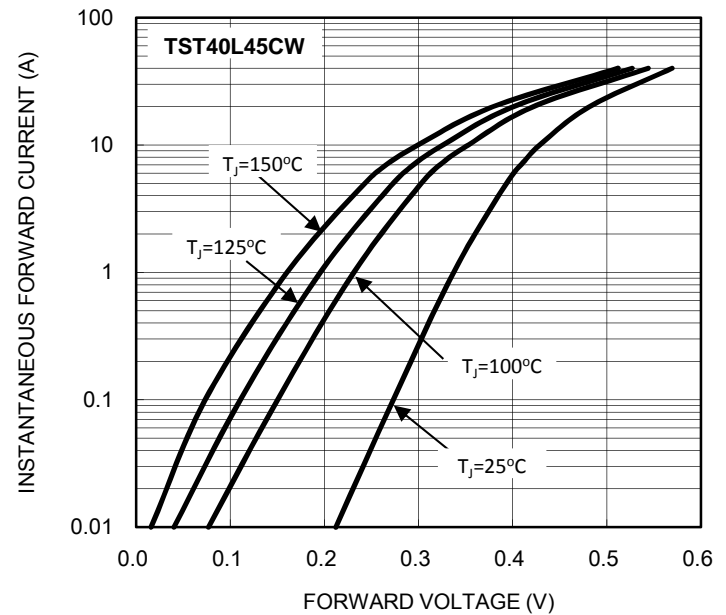

FIG.3 TYPICAL FORWARD CHARACTERISTICS

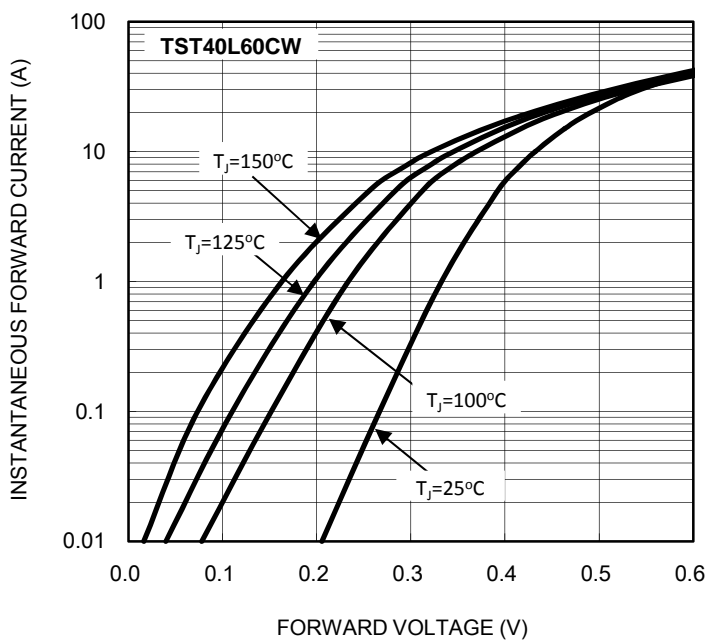

FIG.4 TYPICAL REVERSE CHARACTERISTICS

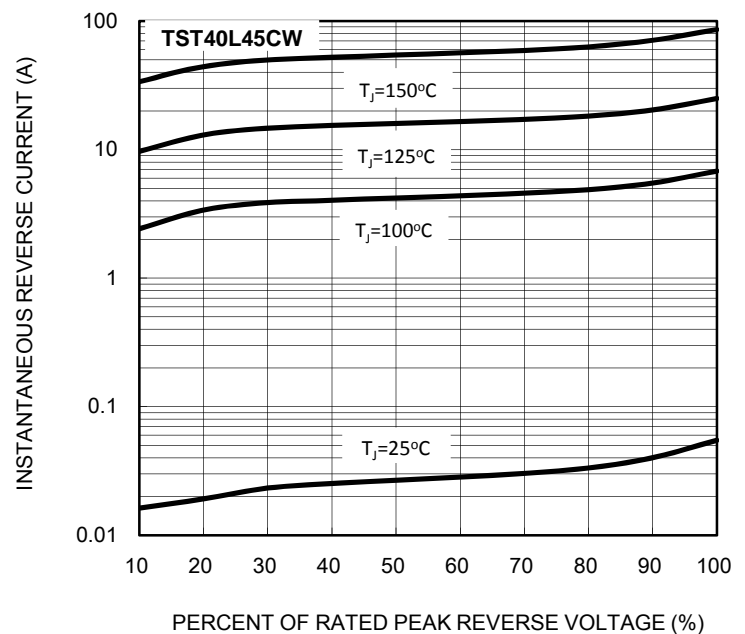

FIG.5 TYPICAL REVERSE CHARACTERISTICS

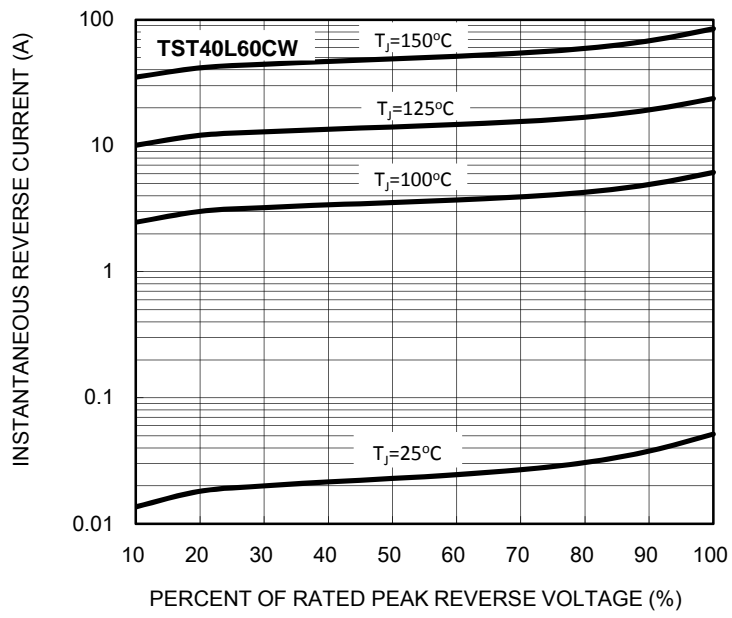

FIG.6 TYPICAL JUNCTION CAPACITANCE

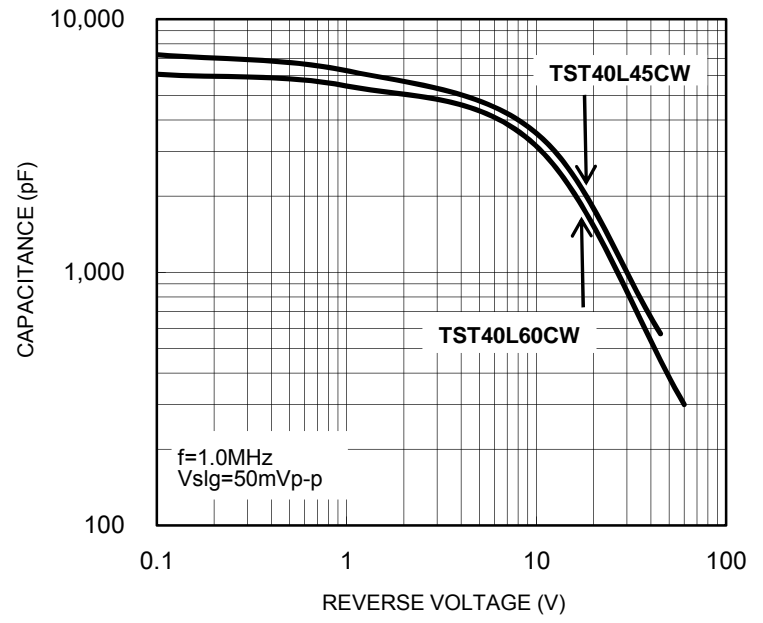
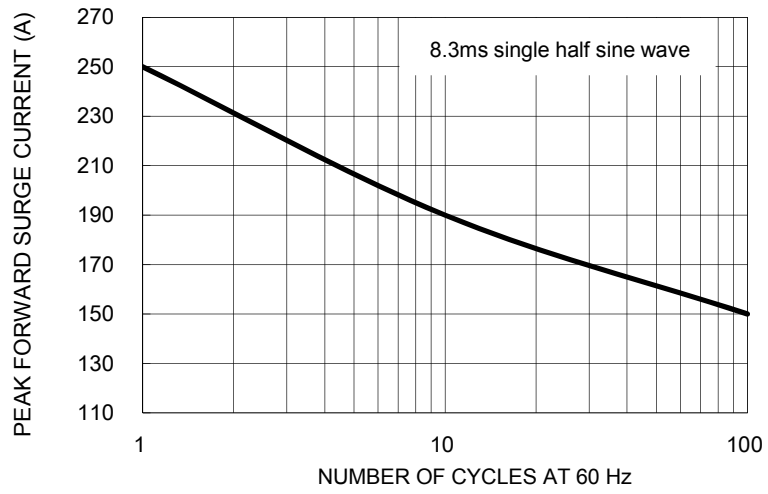
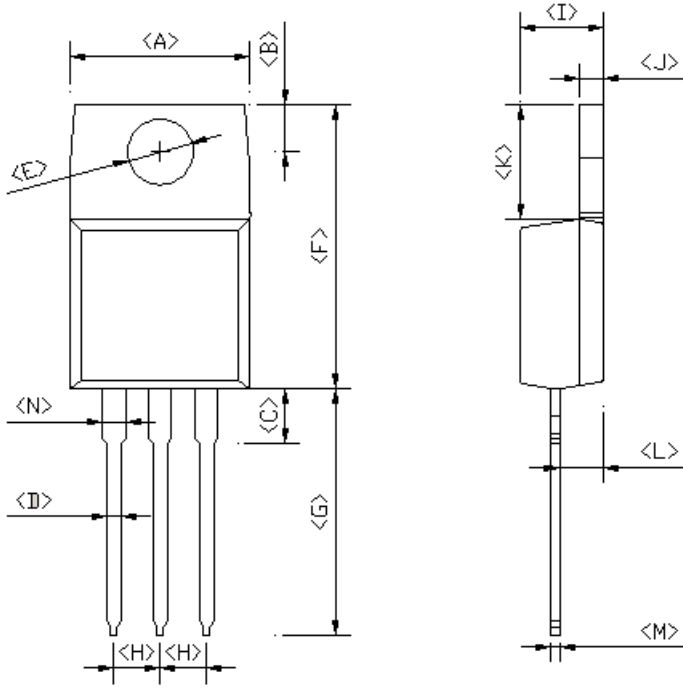

FIG. 7 MAXIMUM NON-REPETITIVE PEAK FORWARD SURGE CURRENT



PACKAGE OUTLINE DIMENSIONS
TO-220AB



DIM.	Unit (mm)		Unit (inch)	
	Min	Max	Min	Max
A	-	10.50	-	0.413
B	2.54	3.44	0.100	0.135
C	2.80	4.20	0.110	0.165
D	0.68	0.94	0.027	0.037
E	3.54	4.00	0.139	0.157
F	14.60	16.00	0.575	0.630
G	13.19	14.79	0.519	0.582
H	2.41	2.67	0.095	0.105
I	4.42	4.76	0.174	0.187
J	1.14	1.40	0.045	0.055
K	5.84	6.86	0.230	0.270
L	2.20	2.80	0.087	0.110
M	0.35	0.64	0.014	0.025
N	0.95	1.45	0.037	0.057

MARKING DIAGRAM



- P/N = Specific Device Code
- G = Green Compound
- YWW = Date Code
- F = Factory Code

Notice

Specifications of the products displayed herein are subject to change without notice. TSC or anyone on its behalf, assumes no responsibility or liability for any errors or inaccuracies.

Information contained herein is intended to provide a product description only. No license, express or implied, to any intellectual property rights is granted by this document. Except as provided in TSC's terms and conditions of sale for such products, TSC assumes no liability whatsoever, and disclaims any express or implied warranty, relating to sale and/or use of TSC products including liability or warranties relating to fitness for a particular purpose, merchantability, or infringement of any patent, copyright, or other intellectual property right.

The products shown herein are not designed for use in medical, life-saving, or life-sustaining applications. Customers using or selling these products for use in such applications do so at their own risk and agree to fully indemnify TSC for any damages resulting from such improper use or sale.



**Стандарт
Электрон
Связь**

Мы молодая и активно развивающаяся компания в области поставок электронных компонентов. Мы поставляем электронные компоненты отечественного и импортного производства напрямую от производителей и с крупнейших складов мира.

Благодаря сотрудничеству с мировыми поставщиками мы осуществляем комплексные и плановые поставки широчайшего спектра электронных компонентов.

Собственная эффективная логистика и склад в обеспечивает надежную поставку продукции в точно указанные сроки по всей России.

Мы осуществляем техническую поддержку нашим клиентам и предпродажную проверку качества продукции. На все поставляемые продукты мы предоставляем гарантию .

Осуществляем поставки продукции под контролем ВП МО РФ на предприятия военно-промышленного комплекса России , а также работаем в рамках 275 ФЗ с открытием отдельных счетов в уполномоченном банке. Система менеджмента качества компании соответствует требованиям ГОСТ ISO 9001.

Минимальные сроки поставки, гибкие цены, неограниченный ассортимент и индивидуальный подход к клиентам являются основой для выстраивания долгосрочного и эффективного сотрудничества с предприятиями радиоэлектронной промышленности, предприятиями ВПК и научно-исследовательскими институтами России.

С нами вы становитесь еще успешнее!

Наши контакты:

Телефон: +7 812 627 14 35

Электронная почта: sales@st-electron.ru

Адрес: 198099, Санкт-Петербург,
Промышленная ул, дом № 19, литера Н,
помещение 100-Н Офис 331