

DSPAUDIOEVM Users Guide

This document contains information on a new product. Specifications and information herein are subject to change without notice.

© Freescale Semiconductor, Inc., 2004. All rights reserved.



Table of Contents

Paragraph Number		Page Number
Chapter 1 Overview		
1.1	Introduction	1
1.2	DSPAUDIOEVM Architecture	1
1.2.1	Daughterboard	1
1.2.2	Motherboard	1
1.3	Debugger Interfaces	1
1.3.1	Suite56 OnCE % Debugger	1
1.3.2	Symphony Debugger Interface	1
1.4	Microcontrollers	2
1.5	Config MPU	2
1.6	Debug MPU	2
1.7	Getting Started	2
1.8	Running the Passthru Code	2
Chapter 2 Motherboard		
2.1	Introduction	3
2.2	Configuration Jumpers	3
2.2.1	JP1/JP2 - S/PDIF Transmitter Output	3
2.2.2	JP3/JP4 – S/PDIF Receiver Input	3
2.2.3	JP5 — Pass-thru Header	3
2.2.4	Debugger and Microcontroller Configuration	4
2.2.4.1	PJ6 Debug MPU Crystal Selection	4
2.2.4.2	JP7 – MPU Program Control	4
2.2.4.3	JP8 – SHI Debug Source Selection	4
2.2.4.4	JP9 – OnCE/JTAG Debugger Source Selection	4
2.2.4.5	JP10 – Config / Debug MPU Communication	5
2.2.4.6	JP11 – AUX Mode Input Source Selection	5
2.3	Signal Headers	5
2.3.1	P1 — PPI Header	5
2.3.2	P2 — OnCE Header	5
2.3.3	P3 — ANALOG I/O	6
2.3.4	TP1 / TP2 Headers	6
2.4	On-board Debugger Connections	6
2.4.1	J2 — USB Interface	6
2.4.2	J3 — RS232 Interface	7
2.4.3	J4 — Parallel Port Debugger Interface	7
2.5	External I/O	7
2.5.1	J9 / J10 — Microphone Inputs	7
2.5.1.1	RV1/RV2 - Microphone Gain Control	7
2.5.2	J11 / J12 — Analog Outputs	7
2.5.3	J13 — Headphone Outputs	8
2.5.3.1	SW2 / SW3 — Channel Select	8
2.5.3.2	RV3 / RV4 — Headphone Volume Select	8
Chapter 3 DSP5636x DAUGHTERBOARD		
3.1	DSPX36XDB1	8
3.2	Mode Selection	8
3.3	Memory	9
3.4	JP11 - Clock Selection	9
3.5	Daughterboard Audio I / O and Clock Control Header	9

Paragraph Number		Page Number
3.5.1	TIO0 – Timmer Port	9
3.5.2	JP1 - Synchronous/Asynchronous Clock Control	9
3.5.3	JP2 – Single/Double Speed Clocking Control	10
3.5.4	JP3 - FST_1 Connection	10
3.5.5	JP4 – SCKT_1 Connection	10
3.5.6	JP5 - FSR_1 Connection	10
3.5.7	JP6 - SCKR_1 Connection	10
3.5.8	JP7 - DSP MUTE Control	10
3.5.9	JP8 - INT_0/SPDIF Error Flag Connection	10
3.5.10	JP9 - SDO5/SDI0 Configuration	10
3.5.11	JP10 SDO4/SDI1 Configuration	10

Chapter 4 DSP56371 DAUGHTERBOARD

4.1	DSPX37XDB1	11
4.2	Mode Selection	11
4.3	Memory	11
4.4	JP1 - Clock Selection	11
4.5	Daughterboard Audio I / O and Clock Control Header	12
4.5.1	JP3 - Synchronous/Asynchronous Clock Control	12
4.5.2	JP4 – Single/Double Speed Clocking Control	12
4.5.3	JP5 - DSP MUTE Control	12
4.5.4	JP6 - FSR_1 Connection	12
4.5.5	JP7 - SCKR_1 Connection	12
4.5.6	JP8 - SCKT_1 Connection	12
4.5.7	JP9 - FST_1 Connection	12
4.5.8	JP10 - SDO5/SDI0 Configuration	12
4.5.9	JP11 - SDO4/SDI1 Configuration	13
4.5.10	JP12 - Master Clock Configuration Control	13
4.5.11	JP13 - SPDIF Lock LED Source Select	13
4.5.12	JP14 - SPDIF Lock Connection	13
4.6	JP2 - I2C Boot ROM Enable	13
4.7	P1 - ESAI Receive In	13
4.8	P2 - ESAI Transmit Out	13

Chapter 5 DSP56374 Daughterboard

5.1	DSPX374DB1	14
5.2	Mode Selection	14
5.3	Memory	14
5.4	JP12 – Clock Selection	14
5.5	Daughterboard Audio I/O and Clock Control Header	15
5.5.1	JP1 – Synchronous/Asynchronous Clock Control	15
5.5.2	JP2 – Single/Double Speed Clocking Control	15
5.5.3	JP3 – FSR_1 Connection	15
5.5.4	JP4 – SCKR_1 Connection	15
5.5.5	JP5 – SDO5/SDI0 Configuration	15
5.5.6	JP6 – SDO4/SDI1 Configuration	15
5.5.7	JP7 – Watchdog Timer Connection	15
5.5.8	JP8 – SD03/SDI2 Configuration	15
5.5.9	JP9 – FST/FST_1 Selection	16
5.5.10	JP10 – SCKT/SCKT_1 Selection	16
5.5.11	JP11 – DSP Mute Control	16
5.5.12	JP13 – I2C Boot ROM Enable	16

Paragraph Number		Page Number
5.5.13	JP14 – S/PDIF Lock Control	16
5.5.14	JP15 – Master Clock Control	16
5.5.15	P1 – ESAI Receive In	16
5.5.16	P2 – ESAI Transmit Out	16

Appendix A Schematics

A.1	Motherboard Schematics	17
A.2	DSP5636x Daughterboard Schematics	29
A.3	DSP56371 Daughterboard Schematics	33
A.4	DSP56374 Daughterboard Schematics	35

Appendix B EVM Bill of Materials

Notes

Chapter 1 Overview

1.1 Introduction

The DSPAUDIOEVM Evaluation Board is used to demonstrate the abilities of the DSP5636x and DSP56367x families of Digital Signal Processors and to provide a hardware tool allowing the development of applications that use these devices.

The DSPAUDIOEVM is designed for the following purposes:

- To allow new users to become familiar with the features of the 56300 architecture: The tools and examples provided with the DSPAUDIOEVM facilitate evaluation of the feature set and the benefits of the family.
- To serve as a platform for real-time software development: The tool suite enables the user to develop and simulate routines, download the software to on-chip or on-board RAM, and then run and debug the software using a debugger via the JTAG/OnCE port or the Serial Host Interface port. The breakpoint features of the OnCE port enable the user to easily specify break conditions and to execute user-developed software at full speed, until the break conditions are satisfied. The ability to examine and modify all user-accessible registers, memory, and peripherals through the OnCE or SHI port greatly facilitates the task of the developer.
- To serve as a platform for hardware development: The hardware platform enables the user to connect external hardware peripherals. The on-board peripherals can be disabled, providing the user with the ability to reassign any and all of the DSP's peripherals. The OnCE port's unobtrusive design means that all of the memory on the board and on the DSP chip is available to the user.

1.2 DSPAUDIOEVM Architecture

The DSPAUDIOEVM system is a development tool for authoring and testing of Digital Audio DSP software. It can also be used as a demo platform for Motorola's digital audio DSP technologies. The EVM system consists of a motherboard and a daughterboard (Ordered separately).

1.2.1 Daughterboard

Several different daughterboards are available to support both 5636x and 5637x Digital Signal Processor families. Each daughterboard connects to the motherboard using two 96-pin connectors and, depending on the DSP, also contains external SRAM, FLASH or EEPROM. (For more information on specific daughterboards see their specific sections of this manual.)

1.2.2 Motherboard

The motherboard has a variety of digital and analog audio I/O including:

- 4 switchable S/PDIF inputs (2 optical and 2 Coaxial)
- 4 simultaneous S/PDIF outputs (3 Coaxial and 1 Coaxial/Optical)
- 12 analog output channels (6 stereo RCA type connectors)
- 2 analog microphone inputs
- 2 analog inputs (1 stereo RCA type connectors)
- Headphone output (can mix any combination of analog signals using switch array)

The motherboard uses an included external universal power supply (100-220VAC, 50-60 Hz). The power supply uses an IEC three pin power connector for the AC supply. The user must supply the AC cable required to connect power to the region specific AC power connection.

1.3 Debugger Interfaces

1.3.1 Suite56 OnCE™ Debugger

The motherboard also supports multiple debugger interfaces. The Motorola high speed parallel port OnCE command converter tool is embedded in the EVM (no special cables are required). An IEEE 1284 Parallel port cable is included in the EVM kit for convenience.

This OnCE interface can be used with the Motorola Suite56 tool set software and documentation available at <http://www.metroworks.com/MW/Develop/Embedded/suite56.htm>

1.3.2 Symphony Debugger Interface

In addition to OnCE debugging, the motherboard includes a real time Symphony Debugger Interface (SDI). This debugger uses either a RS-232 or USB interface and allows SPI or I²C communication to the DSP from a PC for real time debugging and configuration of the DSP. The software and documentation to enable use of the SDI debugger are available on the web: <http://www.motorola.com/dsp> software download.

NOTE

The SDI software is designed for users of ROM-based Software Architecture enabled DSPs. It cannot be used with generic or "B" ROM DSPs.

1.4 Microcontrollers

There are two HC08 Motorola microcontrollers included in this EVM. They each have a dedicated function and are re-flashable in the event a field upgrade is required to the EVM.

1.5 Config MPU

This is an HC908GP32 microcontroller and is pre-programmed with software to enable all of the on-board AKM components and clocking mode changes. This microcontroller also controls the mute functionality of the final audio outputs and the switching of the inputs sourced to the DSP daughterboard.

1.6 Debug MPU

This is an HC908JB16 and is pre-programmed with software to allow communication (from a host PC to the DSP) via the serial RS232 and USB ports in conjunction with the supplied SDI debugger software.

1.7 Getting Started

The first step to using your EVM system is to insert the daughterboard into the motherboard. The connectors are keyed to be inserted in only one direction.

Connecting the power supply is the next step and we recommend always using a grounded AC power cord for both improved audio performance and safety. Connect the power supply to the AC power source first and then to the EVM at the round J1 connector. When the connector is properly seated, all five of the power LEDs located next to the J1 connector should be illuminated.

1.8 Running the Passthru Code

Each daughterboard is shipped with a simple piece of passthru code stored in the on-board FLASH or EEPROM device. To run this code, ensure that the boot mode, controlled by switch SW1, is set to boot the DSP from the on-board FLASH or EEPROM device. See the daughterboard specific section for more information regarding bootmodes.

For the above mentioned passthru function the source device is selected by setting the jumpers of JP11 (AUX in). The default setting from the factory configures the system to source audio data from the optical RX1 S/PDIF input. Alternate settings are described in [Section 2.2.4.6, JP11 – AUX Mode Input Source Selection](#). The DSP passthru software passes the audio sourced from the selected input to the first 4 stereo analog outputs (AOUT 1-4). You can listen to these outputs by connecting an external amplifier and speaker to the RCA outputs or by using the built-in headphone amplifier. To use the headphone output select the desired analog output signals using the left and right channel select switches (SW2/SW3) and adjust the left and right volume sliders (RV3/RV4).

Chapter 2 Motherboard

2.1 Introduction

This section will define the motherboard and daughterboard jumper and switch functionality including their default setting. The jumpers allow flexibility to re-route signals throughout the board, but only the simple jumper settings will be covered in this documentation. More advanced EVM users will be able to experiment with alternate configurations using this section in conjunction with the schematic included in Appendix A. The default jumper settings are indicated with the dark gray boxes.

2.2 Configuration Jumpers

2.2.1 JP1/JP2 - S/PDIF Transmitter Output

The JP1 and JP2 headers are designed to allow selection of the S/PDIF output sources driven by the daughterboard (DSP), AKM 4101 S/PDIF transmitter, or AKM 4114 S/PDIF receiver. The DSP option on these jumpers is for future flexibility to allow for multiple S/PDIF signals to be sourced from the daughterboard directly. One of the S/PDIF signals (TXSD4, TXSD5, or TXSD6) can be directed to the TX4 output by selecting it, using JP2 and selecting the 4101TX4 option in the TX4 section of JP1. The 4114TX jumper option on TX4 is to allow direct connection of the S/PDIF receiver relay to S/PDIF out. The ADO jumper option on TX1 allows the S/PDIF transmitter (DAX port) of certain DSPs to be connected to the S/PDIF output connector.

Table 2-1. JP1 / JP2 – S/PDIF Transmitter Output

TX1			TX2			TX3			TX4			4101TX4		
*	*	*	*	*	*	*	*	*	*	*	*	*	*	*
*	*	*	*	*	*	*	*	*	*	*	*	*	*	*
ADO	DSP	4101	DSP	4101	DSP	4101	DSP	4101TX4	4114TX		TXSD4	TXSD5	TXSD6	
JP1										JP2				

2.2.2 JP3/JP4 – S/PDIF Receiver Input

The JP3 jumper allows for hardware configuration of the AKM 4114 S/PDIF receiver. The default setting is for software control mode and the AKM 4114 is configured by the Motorola HC908GP32 configuration microcontroller on the motherboard.

The JP4 jumper controls the S/PDIF receiver input source to allow direct routing to the daughterboard using the DSP setting or selecting connection to the AKM 4114 (default).

Table 2-2. JP3 / JP4 – S/PDIF Receiver Input

IN=HI		RX1		RX2		RX3		RX4	
*	*	*	*	*	*	*	*	*	*
*	*	*	*	*	*	*	*	*	*
DIF2	DIF0	DSP	4114	DSP	4114	DSP	4114	DSP	4114
JP3		JP4							

2.2.3 JP5 — Pass-thru Header

This jumper block is included to give convenient access to all the critical audio clocks and data lines. These jumpers can be removed to allow for rerouting of the audio signals within the board and to allow for expansion to external boards. As an example, this header could be used to connect to an external audio codec board for evaluation of the Motorola DSP with a specific audio codec.

Table 2-3. JP5 — PASS-THRU Header

MCLK						BICK						LRCLK						SERIAL I / O												MUTE					
* *	* *	* *	* *	* *	* *	* *	* *	* *	* *	* *	* *	* *	* *	* *	* *	* *	* *	* *	* *	* *	* *	* *	* *	* *	* *	* *	* *	* *	* *		* *	* *	* *	* *	* *
RX01	RX02	TX	ADC	DACA	DACB	RX	TX	ADC	DACA	DACB	RX	TX	ADC	DACA	DACB	RX	ADC1	ADC2	TXS01	DACA1/2	TXS02	DACA3/4	TXSD3	DACA5/6	TXSD4	DACB 1/2	TXSD5	DACB3/4	TXCD6	DACB5/6	MUTE	*			

2.2.4 Debugger and Microcontroller Configuration

Table 2-4. Debug and Crystal MPU Settings

JB16 EXTAL		PGM MD			SHI			JTAG			MPU COM				AUX IN=HI									
* *	*	*	*	*	*	*	*	*	*	*	*	*	*	*	*	*	*	*	*	*	*	*	*	
* *	*	*	*	*	*	*	*	*	*	*	*	*	*	*	*	*	*	*	*	*	*	*	*	
RS232	USB/PGM	DEBUG MPU	CONFIG MPU	PGM	PPI PORT	DEBUG MPU	CONFIG MPU	OnCE	USB/RS232	PARALLEL	COM0	COM1	COM2	COM3	AUX1	AUX2	AUX3	AUX4	AUX5					
JP6		JP7			JP8			JP9			JP10				JP11									

2.2.4.1 PJ6 Debug MPU Crystal Selection

The JP6 jumper is for selection of RS232 or USB communication when using the SDI debugger. Note that USB mode is not possible when using the Win NT software version. The RS232 position should be jumped when the RS232 interface is used for the SDI debugger, and the USB/PGM position should be used when using the USB interface for the SDI debugger or when reprogramming of the Debug Micro is required. Only one of these jumpers should be connected at any one time. Use of the wrong jumper setting will cause SDI communication failure to occur or a reduction in the data transfer rate.

2.2.4.2 JP7 – MPU Program Control

The JP7 jumpers are only used when the on-board microcontrollers are to be re-programmed. Placing a jumper in the PGM position places the selected microcontroller in program mode upon power-on. The microcontroller to be programmed is selected by placing a jumper in either the DEBUG MPU or CONFIG MPU positions. With no jumper in the PGM position, the other two jumpers are ignored.

2.2.4.3 JP8 – SHI Debug Source Selection

The JP8 jumpers are for selection of various debugger modes. The default selection is for SDI debugger use. The PPI port can be used with legacy "PPP Development Interface" software and a PPI cable although the latest SDI debugger software is the preferred option for future upgradability and support. The third option, CONFIG MPU, is not currently supported on the EVM. Only one jumper position should be used at any one time.

2.2.4.4 JP9 – OnCE/JTAG Debugger Source Selection

The JP9 jumpers are used for selection of alternative debugging tools such as the Suite 56 OnCE interface mentioned earlier. To use this, simply connect to a host PC with a parallel cable and have a jumper in the PARALLEL positions. The OnCE jumper option can be used if the user wishes to connect an external OnCE/JTAG debugger interface to the board. The USB/RS232 option is not currently supported and only one jumper should be inserted at a time.

2.2.4.5 JP10 – Config / Debug MPU Communication

The JP10 jumpers provide a communication port between the debug microcontroller and the configuration microcontroller. When the SDI debugger is used and the AUX5 jumper is out, the SDI debugger interface controls the audio input source. The JP10 jumpers provide a communication port between the debug microcontroller and the configuration microcontroller. When the SDI debugger is used, and the AUX5 jumper is out, the SDI debugger interface controls the audio input source. To allow this, all JP10 jumpers should be populated.

2.2.4.6 JP11 – AUX Mode Input Source Selection

The JP11 jumpers are present as an alternative to using the SDI debugger software to select between the various inputs available. If the AUX5 jumper is present then the following jumper settings will result in the input selection shown in Table 2-5

Table 2-5. JP11 Selections

Input Selected	Aux5	Aux4*	Aux3	Aux2	Aux1
RX1	1	0	0	0	0
RX2	1	0	0	0	1
RX3	1	0	0	1	0
RX4	1	0	0	1	1
AIN1	1	0	1	0	0
SDI debugger selects input	0	X	X	X	X

* When the Aux5 jumper is present, the Aux4 jumper directly controls the mute functionality of the EVM motherboard.

2.3 Signal Headers

These headers allow for external debugger connections, analog output signal measurement, and GPIO access.

2.3.1 P1 — PPI Header

The PPI header connections are to allow for backwards compatibility with existing PPI software tool set and to allow easy access to the SHI port connections from the motherboard. Note that when using PPI source, JP8 must have PPI Port jumper in place.

Table 2-6. P1 — PPI Header

NC(1)	*	*	SS/HA2
GND	*	*	SCK/SCL
GND	*	*	HREQ
SDA	*	*	MOSI / HA0
VDD	*	*	MISO

2.3.2 P2 — OnCE Header

The P2 OnCE header is for connection of an external OnCE/JTAG debugger tool to the OnCE/JTAG port of the DSP on the daughterboard. Further explanation of the OnCE/JTAG signal definition can be found in the DSP users guides. The P2 OnCE header is for connection of an external OnCE/JTAG debugger tool to the OnCE/JTAG port of the DSP on the daughterboard. Further explanation of the OnCE/JTAG signal definition can be found in the DSP users guides. Note that when using an external OnCE/JTAG debugger tool, the JP9 JTAG jumper should be in the "OnCE" position.

Table 2-7. P2 — OnCE Header

TDI(1)	*	*	GND
TDO	*	*	GND
TCK	*	*	GND
N/C	*		KEY
RESET	*	*	TMS
VDD	*	*	N/C
N/C	*	*	N/C

2.3.3 P3 — ANALOG I/O

The Analog I/O header allows for analog access to input signals before the A/D (AIN1) op-amp stage and the output signals after the D/A (AO1-6) op-amp stage. This section is provided for ease of analog measurement and analog I/O connector relocation.

Table 2-8. P3 — Analog I / O

AO6		AO5		AO4		AO3		AO2		AO1		AIN1	
R	L	R	L	R	L	R	L	R	L	R	L	R	L
*	*	*	*	*	*	*	*	*	*	*	*	*	*
*	*	*	*	*	*	*	*	*	*	*	*	*	*
GND													
P3													

2.3.4 TP1 / TP2 Headers

TP1 and TP2 jumper blocks route to daughterboard for GPIO test points and future flexibility. On the DSP 56362/6/7 parts, as an example, these headers are connected to the DSP HDI08 port. See daughterboard schematics and appendix for device specifics.

Table 2-9. TP1 Header — GP TP1–8

TP1	*	*	TP8
TP2	*	*	TP7
TP3	*	*	TP6
TP4	*	*	TP5

Table 2-10. TP2 Header — GP TP9–16

TP9	*	*	TP16
TP10	*	*	TP15
TP11	*	*	TP14
TP12	*	*	TP13

2.4 On-board Debugger Connections

The connectors discussed in this section are the on-board debuggers. For specific information on using the debuggers, see the relevant User’s Manuals.

2.4.1 J2 — USB Interface

This connector is used in conjunction with the SDI software to debug a DSP using USB communications. See [Section 2.2.4, Debugger and Microcontroller Configuration](#) for the proper jumper settings to use this interface.

2.4.2 J3 — RS232 Interface

This connector can be used for debugging or for in-field updating of the microcontroller code. To use this port for debugging, the SDI software must be used. See [Section 2.2.4, *Debugger and Microcontroller Configuration*](#) for the proper jumper settings to use this interface.

2.4.3 J4 — Parallel Port Debugger Interface

This connector is used for the on-board Suite56 Parallel Port Command Converter. In conjunction with the Suite56 software, this interface provides a high-speed debugger connection through the JTAG/OnCE port of the DSP. See [Section 2.2.4, *Debugger and Microcontroller Configuration*](#) for the proper jumper settings to use this interface.

2.5 External I/O

2.5.1 J9 / J10 — Microphone Inputs

There are two microphone inputs available at 1/8inch microphone connectors J9 and J10 labeled MIC1 and MIC2. These can also be monitored via headphones by switching MIC1 and MIC2 on. The input levels of these can be adjusted with the potentiometers at RV1 and RV2 labeled MIC1 LEVEL and MIC2 LEVEL. These signals are connected to the ADC2 A/D converter.

NOTE

If 1/4 inch to 1/8 inch adaptors are used for the microphone connection use only stereo-stereo or mono-mono style adapters. Stereo-mono or mono-stereo adapters will result in a short of the incoming audio signal to ground.

2.5.1.1 RV1/RV2 - Microphone Gain Control

These potentiometers control the input levels for MIC1 and MIC2 respectively. To prevent damage, always start with these controls in a low setting, i.e., twisted left. These inputs can be monitored directly, using the on-board headphone amplifier.

2.5.2 J11 / J12 — Analog Outputs

Fixed pre-amp outputs (Variable through Digital Volume control on the DSP) are provided for 12 channels of output. These RCA connections can be fed into a variable or fixed amplifier stage. Care should be taken to verify signal integrity before connecting to large fixed amplifiers to avoid audible noise or speaker damage.

These outputs are located at J11 and J12.

Table 2-11. J11

AOUT1	AOUT2	AOUT3
White	White	White
Red	Red	Red

Table 2-12. J12

AOUT4	AOUT5	AOUT6
White	White	White
Red	Red	Red

If using the Software Architecture, the analog outputs correspond to the following:

AOUT1 WHITE	Left Main
AOUT1 RED	Right Main
AOUT2 WHITE	Left Surround
AOUT2 RED	Right Surround
AOUT3 WHITE	Center
AOUT3 RED	Subwoofer
AOUT4 WHITE	Left Back
AOUT4 RED	Right Back

AOUT5 WHITE	Left Secondary
AOUT5 RED	Right Secondary
AOUT6 WHITE	Unassigned
AOUT6 RED	Unassigned

2.5.3 J13 — Headphone Outputs

These channels can also be monitored with the on-board headphone amplifier. The channel listened to is selected via switches SW2 and SW3. Moving the switch to the right will enable the corresponding channel. There are right and left volume sliders (RV3 and RV4) to allow variations in volume level and balance control. Headphones should be plugged in to the J13 1/8-inch headphone connector.

2.5.3.1 SW2 / SW3 — Channel Select

These switches control what is routed to the on-board headphone amplifier. Moving the switch to the right will enable the corresponding channel. Multiple switches/channels can be enabled at one time, and the signals will be summed into the corresponding headphone channel.

2.5.3.2 RV3 / RV4 — Headphone Volume Select

These sliders allow for volume and balance adjustment for the headphone amplifier. To help prevent damage to headphones or hearing, always start with the sliders in a low-volume position.

Chapter 3 DSP5636x DAUGHTERBOARD

3.1 DSPX36XDB1

This daughterboard supports the 56362, 56364, 56366, and 56367. The following sections describe the jumper and switch settings available on the DSPX36XDB1. A schematic for this daughterboard can be found in Appendix A.

3.2 Mode Selection

Various boot-up modes can be selected via the MODE pins and pins PB13 and PB14 settings can be determined using switch bank SW1. Switch position “ON”= signal high. [Table 3-1](#) shows the modes available for the 56362/366/367. [Table 3-2](#) shows the modes available for the 56364. See device-specific user manual for full details of each boot mode.

Table 3-1. Mode Selection for 56362/366/367

MODD	MODC	MODB	MODA	PB14*	PB13*	Mode
0	0	0	0	X	X	Expanded mode (execute from \$C00000)
0	0	0	1	X	X	Bootstrap from external FLASH
0	0	1	0	0	1	Bootstrap SA in SPI mode*
0	0	1	0	1	1	Bootstrap SA in I ² C mode*
0	1	0	1	X	X	Boot from SHI (slave SPI mode)
0	1	1	1	X	X	Boot from SHI (slave I ² C mode)
1	0	0	0	X	X	Expanded mode (execute from \$008000)
1	1	0	0	X	X	Bootstrap in HDI08 ISA mode
1	1	0	1	X	X	Bootstrap in HDI08 HC11 mode
1	1	1	0	X	X	Bootstrap in HDI08 8051 mode
1	1	1	1	X	X	Bootstrap in HDI08 69302 mode

* These modes are only applicable to DSPs which have the embedded ROM based Software Architecture (SA).

NOTE

All other modes are reserved and should not be used.

Table 3-2. Mode Selection for 56364

MODD	MODC	MODB	MODA	Mode
0	X	0	0	Jump to PROM starting address
0	X	0	1	Bootstrap from byte-wide memory
0	X	1	0	Reserved
0	X	1	1	Reserved for Burn-in testing
1	X	0	0	Reserved
1	X	0	1	Bootstrap from SHI (slave SPI mode)
1	X	1	0	Bootstrap from SHI (slave I2C mode, clock freeze enabled)
1	X	1	1	Bootstrap from SHI (slave I2C mode, clock freeze disabled)

3.3 Memory

The daughterboard includes three 128Kx8 SRAM (one 128Kx8 SRAM for the 56364 daughterboard). There is also a 512Kx8 FLASH device resident on the board. From factory the FLASH is programmed with an audio passthru code to allow simple verification of initial board operations. See [Section 1.8, Running the Passthru Code](#) for an explanation of running the passthru code.

3.4 JP11 - Clock Selection

Jumper bank JP11 allows for the following clocking modes:

OSC – Clock DSP from canned oscillator at U7 (not Populated)

XTAL – Clock DSP from 24.576MHz crystal at X1 (default mode)

EXT – Clock DSP from motherboard 24.576MHz clock source

Only one of the JP11 options should be populated at the same time.

3.5 Daughterboard Audio I / O and Clock Control Header

Table 3-3. Daughterboard Audio I / O and Clock Control Header

TIO0	Sync/Async			Sng/DbI		FST_1		SCKT_1		FSR_1	SCKR_1	DSP MUTE	INTO	SDO5/SDIO		SDO4/SDI1	
	*	*	*	*	*	*	*	*	*	*	*	*	*	*	*	*	*
A	B	C	D	E	F	G	H	I	J	K	L	M	N	O	P	Q	
TIO	JP1		JP2		JP3		JP4		JP5	JP6	JP7	JP8	JP9		JP10		

3.5.1 TIO0 – Timmer Port

This is connected directly to the TIO0 pin on the DSP.

3.5.2 JP1 - Synchronous/Asynchronous Clock Control

This jumper set controls whether or not the DSP is in synchronous or asynchronous mode. Position B allows the DSP GPIO (pin PB9) to choose the mode. Position C forces the mode to be asynchronous, and no jumper forces synchronous mode. In synchronous mode FST is connected to FSR, and SCKT is connected to SCKR on the ESAI port of the DSP.

3.5.3 JP2 – Single/Double Speed Clocking Control

This jumper set controls whether or not the motherboard is in single or double speed mode. Position D forces the motherboard into double speed mode. Position E allows the DSP GPIO pin PB11 to control the mode (e.g., through a PPP), and no jumper forces single speed mode. An example of this signal's use is for decoding of DTS 96/24 content. In this mode, it is required to update the masterclock ration expectation in the D/A converters and S/PDIF transmitters because the DTS 96/24 decoder doubles the audio sample rate as part of the decoding process.

3.5.4 JP3 - FST_1 Connection

This set of jumpers determines which frame sync clock source is used for the AKM DAC4_6. The F position directs the ESAI_0 FST signal to DAC4_6. Position G directs the ESAI_1 FST signal to DAC4_6, and population of both jumpers will synchronize/short the two ESAI port FST lines.

NOTE

Position F should always be populated when using a 56362 or 56364 daughterboard.

3.5.5 JP4 – SCKT_1 Connection

This set of jumpers determines which serial clock source is used for the AKM DAC4_6. Position H directs the ESAI_0 SCKT signal to DAC4_6, position I directs the ESAI_1 SCKT signal to DAC4_6 and population of both jumpers will synchronize/short the two ESAI port SCKT lines.

NOTE

Position H should always be populated when using a 56362 or 56364 daughterboard.

3.5.6 JP5 - FSR_1 Connection

This jumper connects/shorts the FSR and FSR_1 signals together. No jumper means that the FSR_1 signal stops at the header.

3.5.7 JP6 - SCKR_1 Connection

This jumper connects/shorts the SCKR and SCKR_1 signals together. No jumper means that the SCKR_1 signal stops at the header.

3.5.8 JP7 - DSP MUTE Control

This jumper controls the mute signal when used in conjunction with the Software Architecture or GPIO control. With the jumper in place, the mute control is connected to the DSP GPIO pin PB12. No jumper means that mute functionality will only be controlled by the motherboard.

3.5.9 JP8 - INT_0/SPDIF Error Flag Connection

This jumper connects the error flag signal from the AKM 4114 to the DSP GPIO pin PB15. This allows the DSP to be informed of the status of the AKM 4114 S/PDIF receiver. If the connection is not desired this jumper can be removed.

3.5.10 JP9 - SDO5/SDI0 Configuration

This jumper set controls the signal connections of SDO5/SDI0. Depending on the ESAI setting in the DSP, this pin can be configured as an input or an output. A jumper in position N feeds the SDI0 signal from the ADC2 microphone source. A jumper in the O position feeds the SDO5 signal to DAC4_6.

3.5.11 JP10 SDO4/SDI1 Configuration

This jumper set controls the input source for SDI1. A jumper in the P position feeds the SDI1 signal from the AKM 4114 S/PDIF receiver. A jumper in the Q position feeds the SDI1 signal from ADC1. There is no available jumper setting for use of the SDO4 signal.

Chapter 4

DSP56371 DAUGHTERBOARD

4.1 DSPX37XDB1

The following section describes the jumper and switch options for the DSPX37XDB1. The schematic for the daughterboard can be found in [Section A, Schematics](#) for clarification of all DSP connections.

NOTE

Two versions of the DSPX37XDB1 exist: Rev C and Rev D. You can determine the revision by looking at the bottom side of the board just below the serial number. This section documents Rev D of the board which is the current production revision. While the jumper sets are numbered differently between the revisions, the functional descriptions remain the same. The only functional difference between revisions is the addition of the boot from on-board serial EEPROM available only on the Rev D board. Schematics for the Rev C board are not included in this manual but are available upon request.

Table 4-1. Mode Selection

MODD	MODC	MODB	MODA	TP14	TP13	Mode
0	0	1	0	0	1	Bootstrap SA in SPI mode
0	0	1	0	1	1	Bootstrap SA in I ² C mode
0	1	0	1	X	X	Bootstrap from SHI (slave SPI) mode
0	1	1	1	X	X	Bootstrap from SHI (slave I ² C) mode
1	0	0	1	X	X	Bootstrap from SHI (serial EEPROM) mode

NOTE

All other modes are reserved and should not be used.

4.2 Mode Selection

Various boot-up modes can be selected via the MODE pins and pins TP13 and TP14 settings can be determined using switch bank SW1. Switch position "ON"= signal high. See the DSP56371 user manual for full details.

4.3 Memory

The DSPX37XDB1 daughterboard includes one 1Mx8 EEPROM accessed by an I²C-compatible bus. This memory comes pre-programmed with a basic audio passthru code to allow simple verification of the initial board operations. See [Section 1.8, Running the Passthru Code](#) for more details.

4.4 JP1 - Clock Selection

Jumper bank JP1 allows for the following clocking modes:

- OSC – Clock DSP from canned oscillator at U7 (not Populated)
- XTAL – Clock DSP from 24.576MHz crystal at X1 (default mode)
- EXT – Clock DSP from motherboard 24.576MHz clock source

Only one of the JP1 options should be populated at the same time.

4.5 Daughterboard Audio I / O and Clock Control Header

Table 4-2. Daughterboard Audio I/O and clock Control Header

SYNC/ASYNC		SNG/DBL		DSP MUTE	FSR_1	SCKR_1	SCKT_1		FST_1		SD05/SDI0		SD04/SDI1		4114MCLK PF8MCLK JCLT_1			LED = DSP PF6 LED = 4114 INTO		4114 INTO = DSP PF6
*	*	*	*	*	*	*	*	*	*	*	*	*	*	*	*	*	*	*	*	*
*	*	*	*	*	*	*	*	*	*	*	*	*	*	*	*	*	*	*	*	*
A	B	C	D	E	F	G	H	I	J	K	L	M	N	O	P	Q	R	S	T	U
JP3		JP4		JP5	JP6	JP7	JP8		JP9		JP10		JP11		JP12			JP13		JP14

4.5.1 JP3 - Synchronous/Asynchronous Clock Control

This jumper set controls whether or not the DSP is in synchronous or asynchronous mode. Position A allows the DSP GPIO (pin PB1) to choose the mode. Position B forces the mode to be asynchronous, and no jumper forces synchronous mode. In synchronous mode FST is connected to FSR, and SCKT is connected to SCKR on the ESAI port of the DSP.

4.5.2 JP4 – Single/Double Speed Clocking Control

This jumper set controls whether or not the motherboard is in single or double speed mode. Position C forces the motherboard into double speed mode. Position D allows the DSP GPIO pin PE10 to control the mode (e.g., through a PPP), and no jumper forces single speed mode. An example of this signal's use is for decoding of DTS 96/24 content. In this mode, it is required to update the masterclock ration expectation in the D/A converters and S/PDIF transmitters because the DTS 96/24 decoder doubles the audio sample rate as part of the decoding process.

4.5.3 JP5 - DSP MUTE Control

This jumper controls the mute signal when used in conjunction with the Software Architecture or GPIO control. With the jumper in place, the mute control is connected to the DSP GPIO pin PE11. No jumper means that mute functionality will only be controlled by the motherboard.

4.5.4 JP6 - FSR_1 Connection

This jumper connects/shorts the FSR and FSR_1 signals together. No jumper means that the FSR_1 signal stops at header P1.

4.5.5 JP7 - SCKR_1 Connection

This jumper connects/shorts the SCKR and SCKR_1 signals together. No jumper means that the SCKR_1 signal stops at header P1.

4.5.6 JP8 - SCKT_1 Connection

This set of jumpers determines which serial clock source is used for the AKM DAC4_6. Position I directs the ESAI_0 SCKT signal to DAC4_6, position H directs the ESAI_1 SCKT signal to DAC4_6 and population of both jumpers will synchronize/short the two ESAI port SCKT lines.

4.5.7 JP9 - FST_1 Connection

This set of jumpers determines which frame sync clock source is used for the AKM DAC4_6. The K position directs the ESAI FST signal to DAC4_6. Position J directs the ESAI_1 FST signal to DAC4_6, and population of both jumpers will synchronize/short the two ESAI port FST lines.

4.5.8 JP10 - SDO5/SDI0 Configuration

This jumper set controls the signal connections of SDO5/SDI0. Depending on the ESAI setting in the DSP, this pin can be configured as an input or an output. A jumper in position L feeds the SDI0 signal from the ADC2 microphone source. A jumper in the M position feeds the SDO5 signal to DAC4_6.

4.5.9 JP11 - SDO4/SDI1 Configuration

This jumper set controls the input source for SDI1. A jumper in the N position feeds the SDI1 signal from the AKM 4114 S/PDIF receiver. A jumper in the O position feeds the SDI1 signal from ADC1. There is no available jumper setting for use of the SDO4 signal.

4.5.10 JP12 - Master Clock Configuration Control

This set of jumpers allows for numerous routing options of the master clock. A jumper in the P position feeds the master clock from the AKM4114 SPDIF receiver to the ESAI HCKT, HCKR and ACI pins as well as the AKM4114 SPDIF transmitter, ADC, DAC1-3 and DAC4-6. A jumper in the R position connects/shorts the HCKT_1 signal to the HCKT, HCKR and ACI signals. Jumper positions P and R may be used together to feed the AKM4114 SPDIF master clock to the HCKT_1 input. Jumper position Q is reserved for future expansion.

4.5.11 JP13 - SPDIF Lock LED Source Select

This jumper set controls the source for the SPDIF lock LED, D6, on the motherboard. A jumper in location T allows connects LED, D6, to the AKM4114 lock signal output. Jumper position S is reserved for future expansion.

4.5.12 JP14 - SPDIF Lock Connection

This jumper connects the AKM4114 lock signal to GPIO signal PF6 if jumper set JP13 has a jumper in location T.

4.6 JP2 - I²C Boot ROM Enable

This set of jumpers allows the on-board serial EEPROM to be removed from the SHI bus. Jumper location V connects the serial data line to the DSP MISO signal and location W connects the serial clock line to the DSP SCK signal. Both jumpers must be placed to use bootstrap mode 9.

4.7 P1 - ESAI Receive In

This header allows for external connections to ESAI and ESAI_1 receiver signals and GPIO. The odd row is ground while the even row of pins is signal. This provides ground isolation between each signal when used with ribbon cable connectors.

4.8 P2 - ESAI Transmit Out

This header allows for external connections to ESAI and ESAI_1 transmitter signals and GPIO. The odd row is ground while the even row of pins is signal. This provides ground isolation between each signal when used with ribbon cable connectors.

Chapter 5

DSP56374 Daughterboard

5.1 DSPX374DB1

This daughterboard supports all versions of the 56374. The following sections describe the jumper and switch options available on the DSPX374DB1. The schematic for this daughterboard can be found in Appendix A.

5.2 Mode Selection

Various bootstrap modes can be selected via switch bank SW1. [Table 5-1](#) shows the switch configuration for each available mode. See the 56374 User's Manual for full details on each mode.

Table 5-1. Mode Selection

MODD	MODC	MODB	MODA	Mode
0	0	1	0	Bootstrap SA in SPI mode
0	1	0	1	Bootstrap from SHI (slave SPI) mode
0	1	1	0	Bootstrap from SHI (slave I ² C, HCKFR=1) mode
0	1	1	1	Bootstrap from SHI (slave I ² C, HCKFR=0) mode
1	0	0	1	Bootstrap from SHI (serial EEPROM, HCKFR=1) mode
1	0	1	1	Bootstrap from SHI (serial EEPROM) mode
1	1	0	0	Bootstrap from SHI (serial SPI EEPROM) mode
1	1	1	0	Bootstrap SA (default HLX) in SPI mode
1	1	1	0	Bootstrap SA in I ² C (HCKFR=0) mode
1	1	1	1	Bootstrap SA in I ² C (HCKFR=1) mode

NOTE

All other modes are reserved and should not be used.

5.3 Memory

The DSPX374DB1 daughterboard includes one 1Mx8 EEPROM accessed by an I²C-compatible bus. This memory comes pre-programmed with a basic audio passthru code to allow simple verification of the initial board operations. See [Section 1.8, Running the Passthru Code](#) for more details.

5.4 JP12 – Clock Selection

Jumper bank JP12 allows for the following clocking modes:

XTAL – Clock DSP from 24.576MHz crystal at X1 using the DSP's internal oscillator

EXT – Clock DSP from motherboard 24.576MHz clock source

OSC – Clock DSP from canned oscillator at U4 (not populated)

When using the XTAL clocking mode both XTAL jumpers must be placed (this is the default mode of operation). When using other clocking modes, both XTAL jumpers must be removed. Only one clocking mode should be used at the same time

5.5 Daughterboard Audio I/O and Clock Control Header

Table 5-2. Daughterboard Audio I/O and clock Control Header

SYNC/ASYNC		SNG/DBL		FSR_1	SCKR_1	SD05/SDI0		SD04/SDI1		WDT/RESET	SD03/SDI2		FST_1 FST		SCKT_1 SCKT		DSP MUTE
*	*	*	*	*	*	*	*	*	*	*	*	*	*	*	*	*	*
*	*	*	*	*	*	*	*	*	*	*	*	*	*	*	*	*	*
A	B	C	D	E	F	G	H	I	J	K	L	M	N	O	P	Q	R
JP1		JP2		JP3	JP4	JP5		JP6		JP7	JP8		JP9		JP10		JP11

5.5.1 JP1 – Synchronous/Asynchronous Clock Control

This jumper set controls whether or not the DSP is in synchronous or asynchronous mode. Position A allows the DSP GPIO (pin PG7) to choose the mode. Position B forces the mode to be asynchronous and no jumper forces synchronous mode. In synchronous mode FST is connected to FSR and SCKT is connected to SCKR on the ESAI port of the DSP.

5.5.2 JP2 – Single/Double Speed Clocking Control

This jumper pair controls whether or not the motherboard is in single or double speed mode. Position C forces the motherboard into double speed mode. Position D allows the DSP GPIO (pin PG6) to control the mode and no jumper forces single speed mode. This jumper is useful when implementing a DTS 96/24 decoder.

5.5.3 JP3 – FSR_1 Connection

This jumper connects/shorts the FSR and FSR_1 signals together. No jumper means that the FSR_1 signal stops at header P1.

5.5.4 JP4 – SCKR_1 Connection

This jumper connects/shorts the SCKR and SCKR_1 signals together. No jumper means that the SCKR_1 signal stops at header P1.

5.5.5 JP5 – SDO5/SDI0 Configuration

This jumper pair controls the input source for SDI0. A jumper in position G feeds the SDI0 signal from the AKM 4114 S/PDIF receiver. A jumper in position H feeds the SDI0 signal from ADC1. There is no available jumper setting for use of the SDO5 signal.

5.5.6 JP6 – SDO4/SDI1 Configuration

This jumper set controls the signal connections of SDO4/SDI1. Depending on the ESAI configuration in the DSP, this signal can be configured as an output (SDO4) or an input (SDI1). A jumper in position I feeds the SDI1 signal from ADC1. A jumper in position J feeds the SDO4 signal to DAC4-6.

5.5.7 JP7 – Watchdog Timer Connection

This jumper connects the on-chip watchdog timer output to the DSP reset circuit. By placing a jumper in position K the on-chip watchdog timer can generate a hardware reset to the DSP. If no jumper is placed the watchdog timer is removed from the reset circuit.

5.5.8 JP8 – SD03/SDI2 Configuration

This jumper pair controls the signal connections of SDO3/SDI2. Depending on the ESAI configuration in the DSP, this signal can be configured as an output (SDO3) or an input (SDI1). A jumper in position L feeds the SDI1 signal from the ADC2 microphone source. A jumper in position M feeds the SDO3 signal to DAC 4-6.

5.5.9 JP9 – FST/FST_1 Selection

This jumper set determines which frame sync clock source is used for DAC4-6. A jumper in position O directs the ESAI FST signal to DAC4-6. A jumper in position N directs the ESAI_1 FST signal to DAC4-6. If both jumpers are placed this will connect/short the FST and FST_1 signals together.

5.5.10 JP10 – SCKT/SCKT_1 Selection

This jumper pair controls which serial clock source is used for DAC4-6. A jumper in position Q directs the ESAI SCKT signal to DAC4-6. A jumper in position P directs the ESAI_1 SCKT signal to DAC4-6. If both jumpers are placed this will connect/short the SCKT and SCKT_1 signals together.

5.5.11 JP11 – DSP Mute Control

This jumper controls the mute signal when used in conjunction with the Software Architecture or GPIO control. With the jumper in place the mute control is connected to the DSP GPIO (pinPG5). No jumper means that the mute functionality will only be controlled by the motherboard.

5.5.12 JP13 – I2C Boot ROM Enable

This set of jumpers allows the on-board serial EEPROM to be removed from the SHI bus. Jumper location W connects the serial data line to the DSP MISO signal and location X connects the serial clock line to the DSP SCK signal. Both jumpers must be placed to use bootstrap modes 9 or B.

5.5.13 JP14 – S/PDIF Lock Control

This jumper is designed for future compatibility. For proper operation a jumper should be placed in position U.

5.5.14 JP15 – Master Clock Control

This jumper pair allows the DSP to supply a master transmit clock from either ESAI port via the HCKT signal. A jumper in position S sources the transmit master clock from the AKM 4114 S/PDIF receiver, while a jumper in position T sources the transmit master clock from either HCKT or HCKT_1 (these signals are connected/shorted together in either jumper position).

5.5.15 P1 – ESAI Receive In

This header allows for external connections to ESAI and ESAI_1 receiver signals and GPIO. The odd row is ground while the even row of pins is signal. This provides ground isolation between each signal when used with ribbon cable connectors.

5.5.16 P2 – ESAI Transmit Out

This header allows for external connections to ESAI and ESAI_1 transmitter signals and GPIO. The odd row is ground while the even row of pins is signal. This provides ground isolation between each signal when used with ribbon cable connectors.

Appendix A Schematics

A.1 Motherboard Schematics

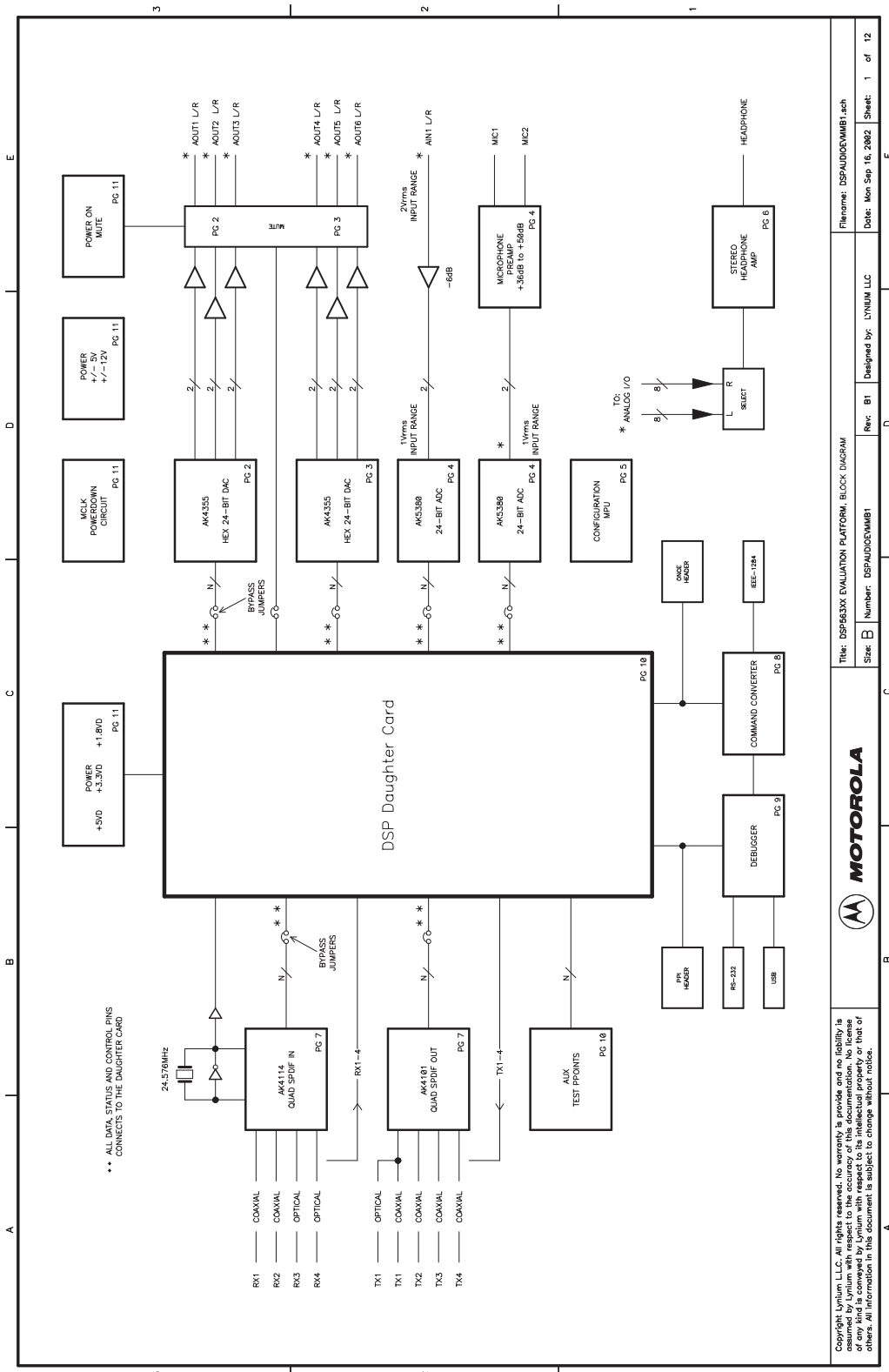

Figure A-1. Motherboard Block Diagram

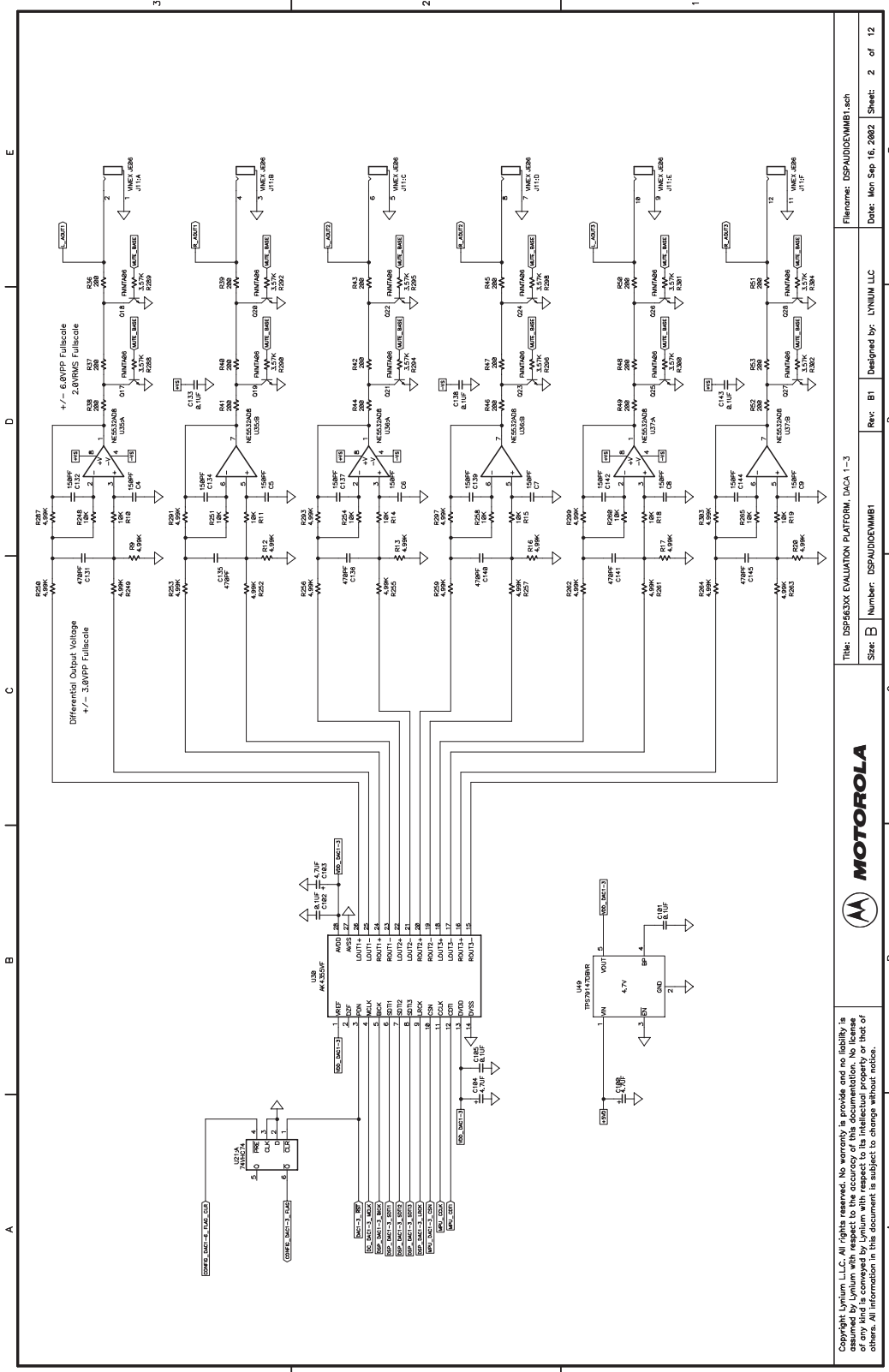

Figure A-2. Motherboard DACA 1-3



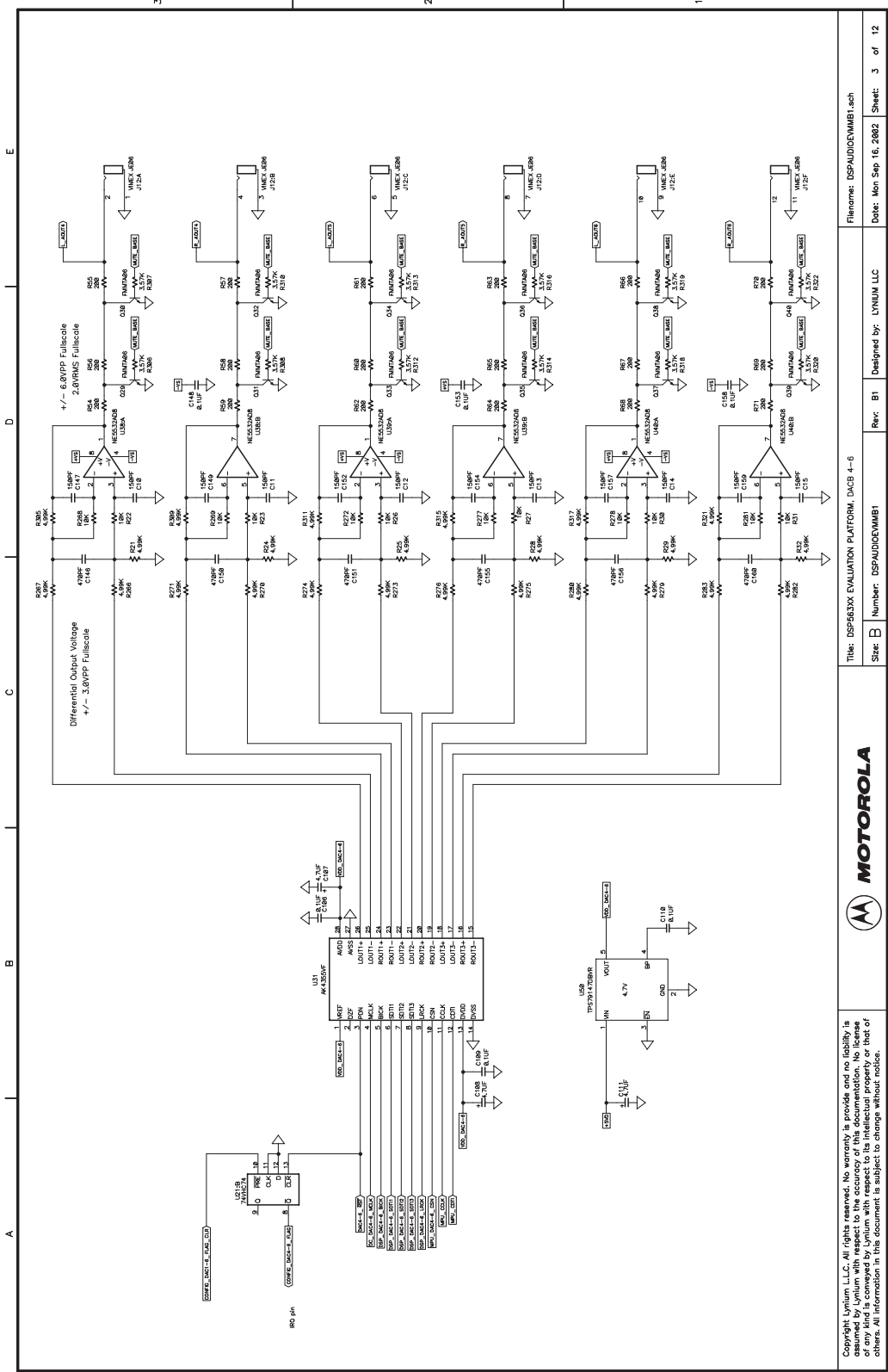

Figure A-3. Motherboard DACB 4-6

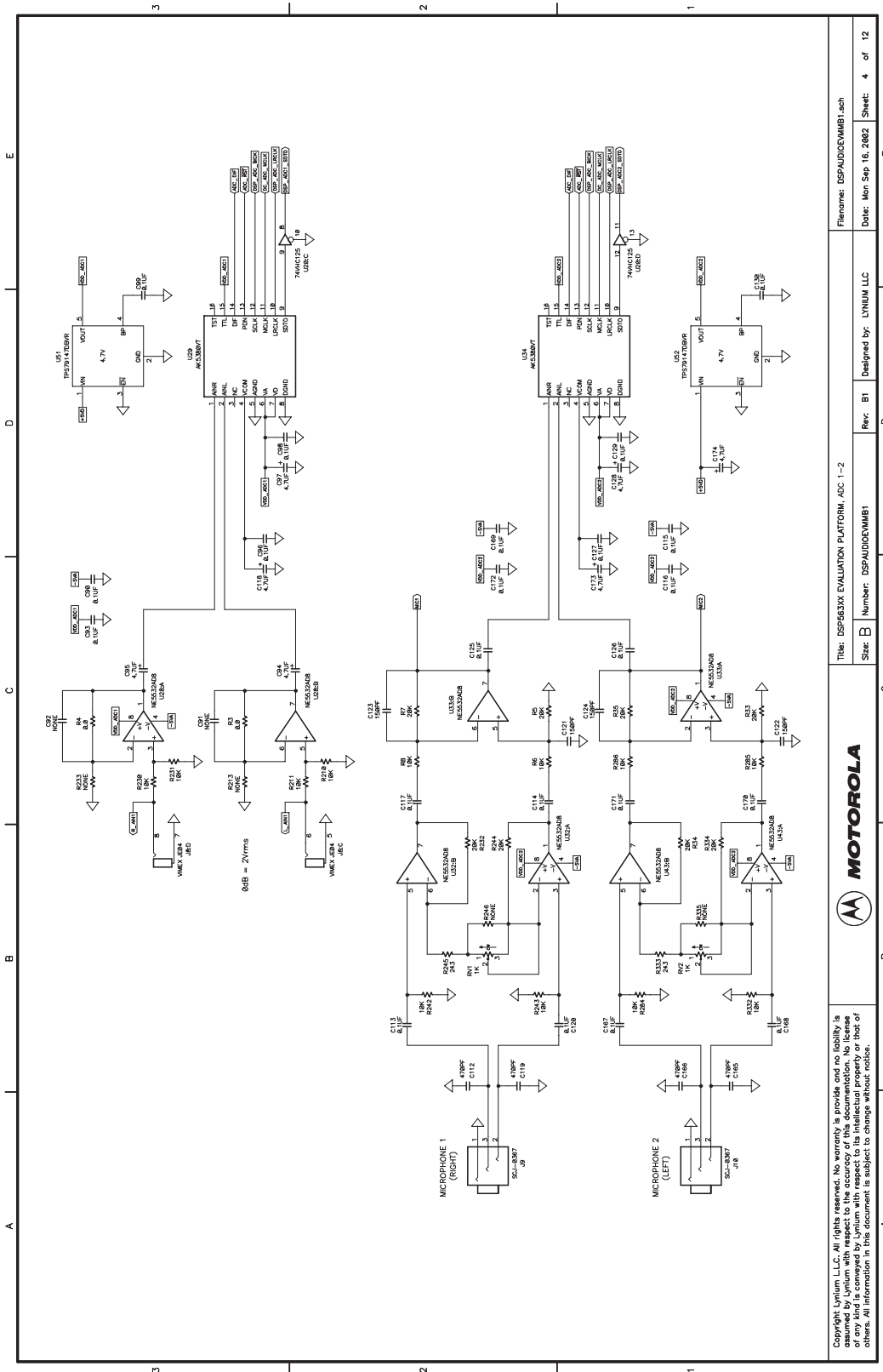

Figure A-4. Motherboard ADC 1-2

Copyright Lynium LLC. All rights reserved. No warranty is provided and no liability is assumed by Lynium with respect to the accuracy of this documentation. No license of any kind is conveyed by Lynium with respect to its intellectual property or that of others. All information in this document is subject to change without notice.

MOTOROLA

Title: DSP663X EVALUATION PLATFORM, ADC 1-2

Rev: B Number: DSPAUDIOEVM01

Designed by: LYNIUM LLC

Date: Mon Sep 16, 2002

Sheet: 4 of 12

Filename: DSPAUDIOEVM01.sch

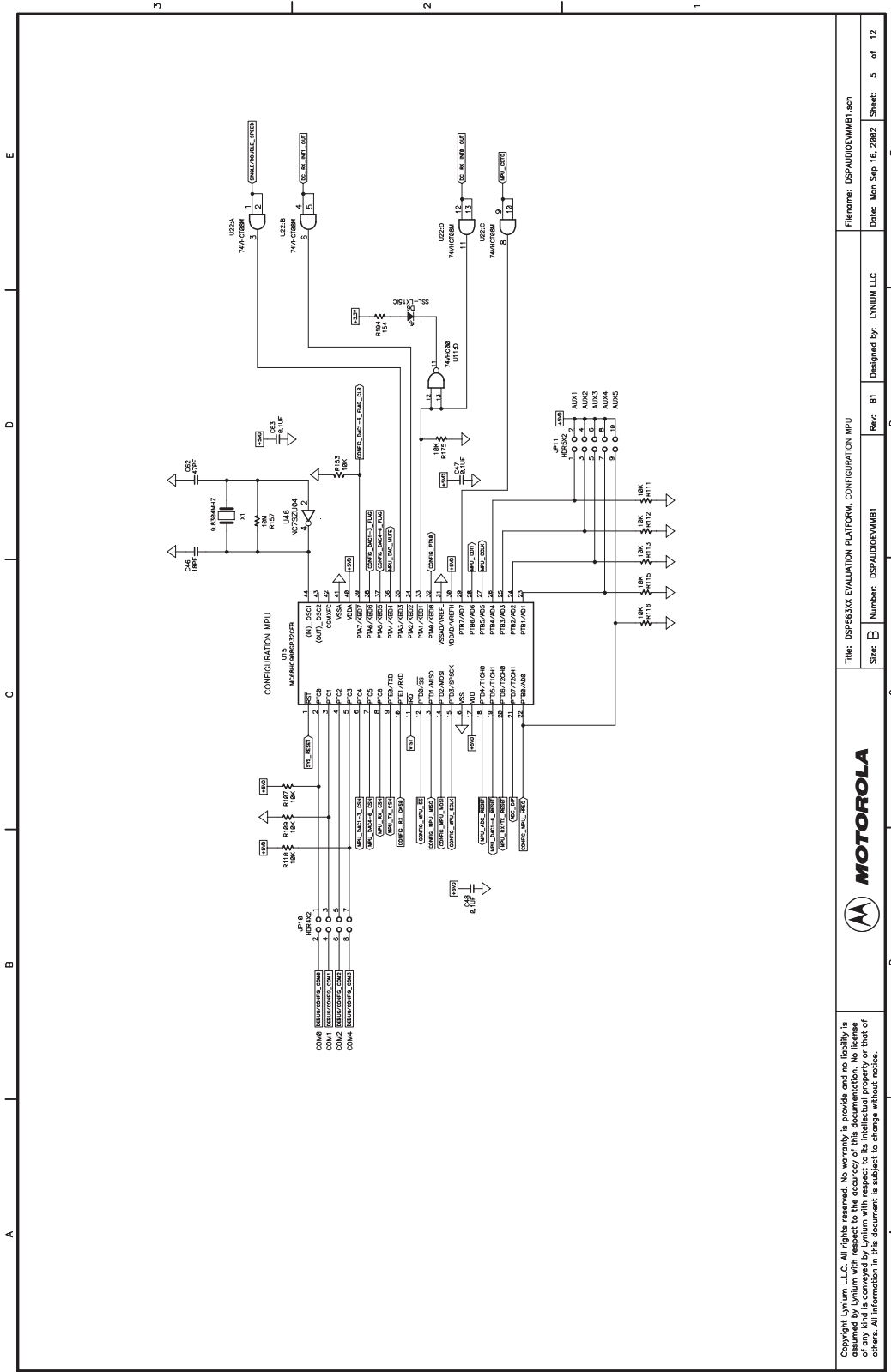

Figure A-5. Motherboard Configuration MPU

		Title: DSPBESX EVALUATION PLATFORM: CONFIGURATION MPU Part Number: DSPAUDIOEVM01	
Copyright Lynium LLC. All rights reserved. No warranty is provided and no liability is assumed by Lynium with respect to the accuracy of this documentation. No license of any kind is conveyed by Lynium with respect to its intellectual property or that of others. All information in this document is subject to change without notice.		File Name: DSPAUDIOEVM01.sch Date: Mon Sep 16, 2002 Sheet: 5 of 12	

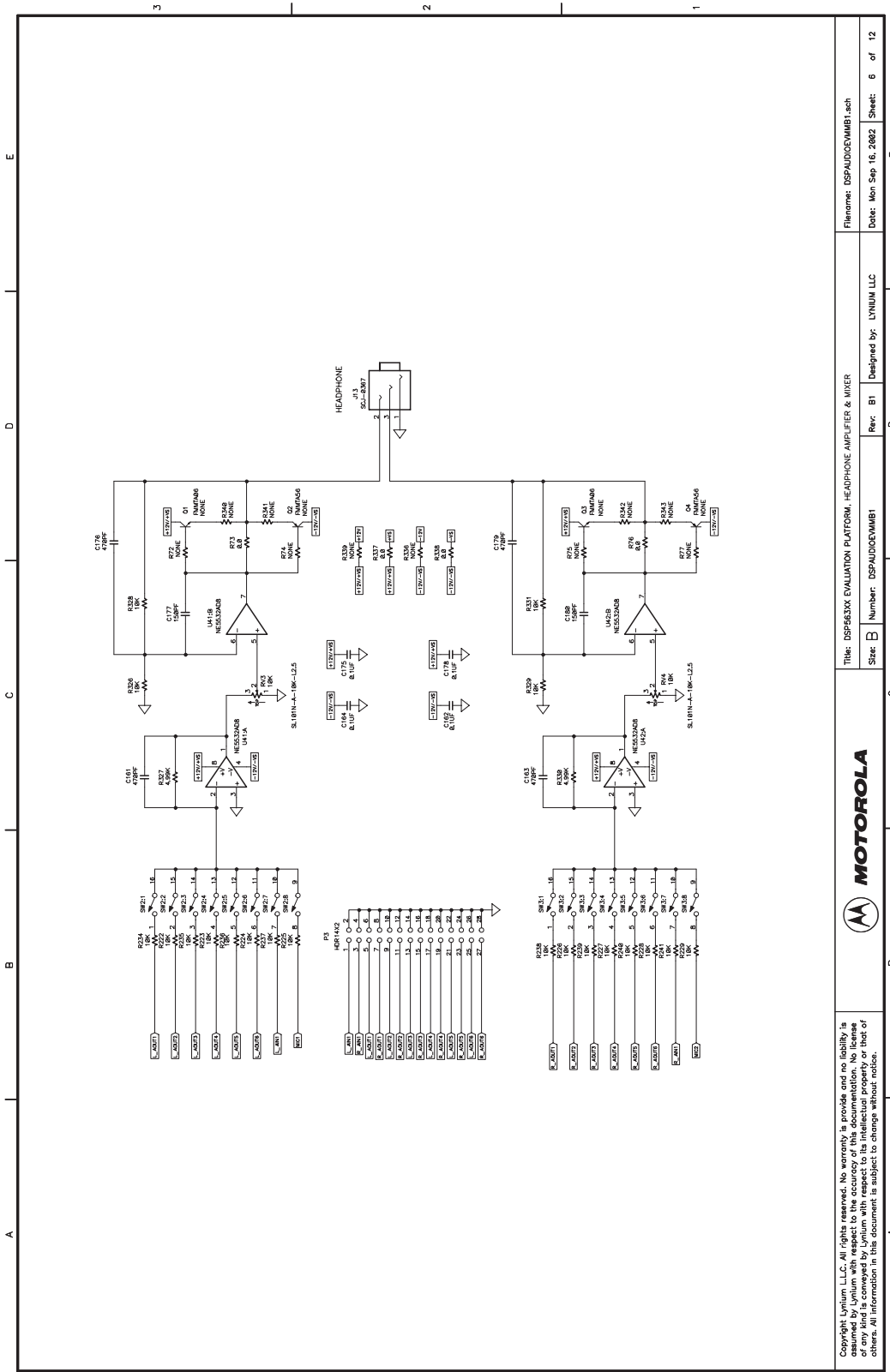

Figure A-6. Motherboard Headphone Amplifier and Mixer

<p>Copyright Lynium LLC. All rights reserved. No warranty is provided and no liability is assumed by Lynium with respect to the accuracy of this documentation. No license of any kind is conveyed by Lynium with respect to its intellectual property or that of others. All information in this document is subject to change without notice.</p>		<p>MOTOROLA</p>		<p>Thir: DSP653X EVALUATION PLATFORM, HEADPHONE AMPLIFIER & MIXER</p>		<p>Filename: DSPAUDIOEVM1.sch</p>	
<p>Rev: B</p>		<p>Number: DSPAUDIOEVM1</p>		<p>Designed by: LYNIMUM LLC</p>		<p>Date: Mon Sep 16, 2002</p>	
<p>Sheet: 6</p>		<p>of 12</p>		<p>Sheet: 6</p>		<p>of 12</p>	

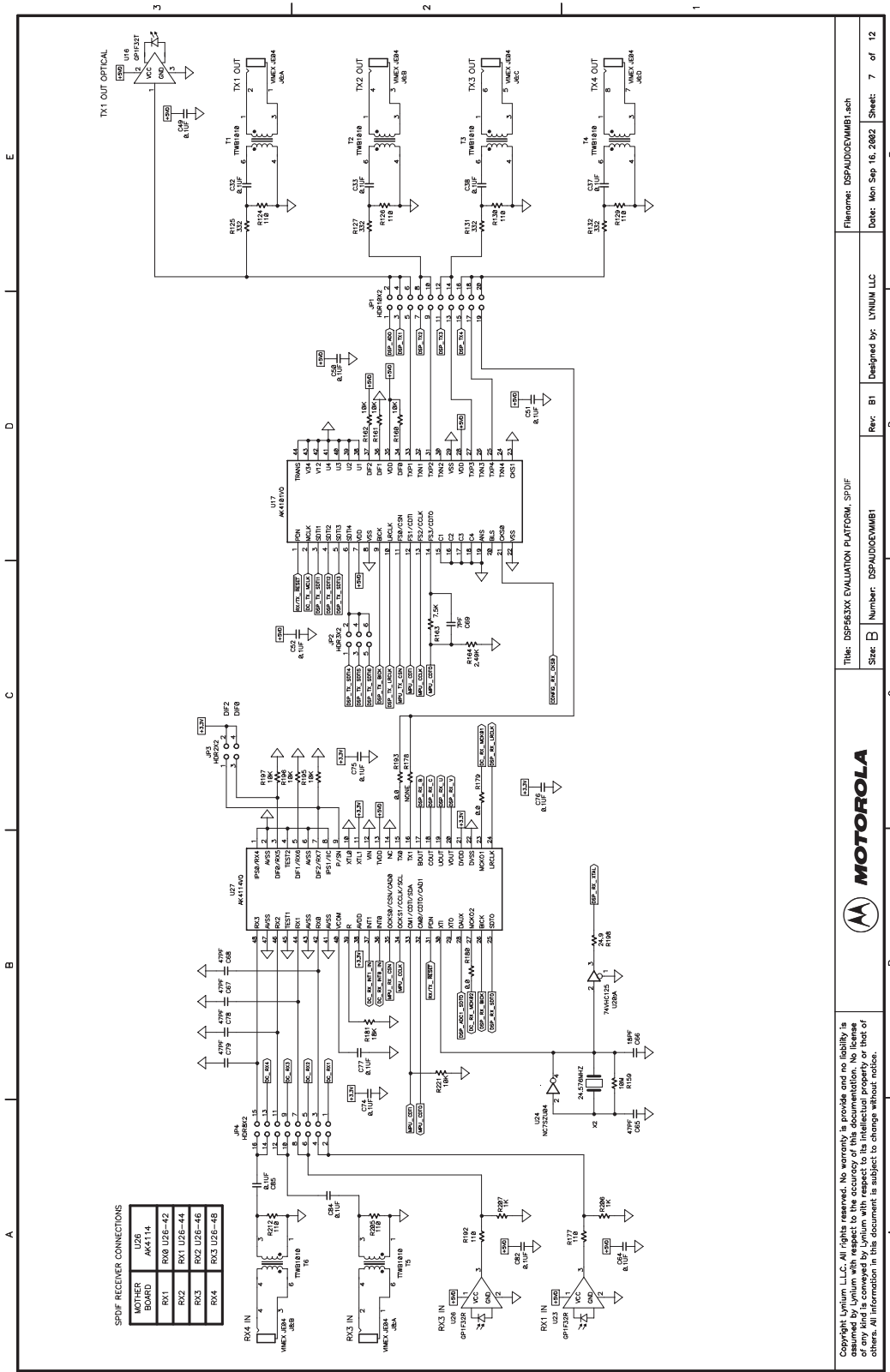

Figure A-7. Motherboard SPDIF

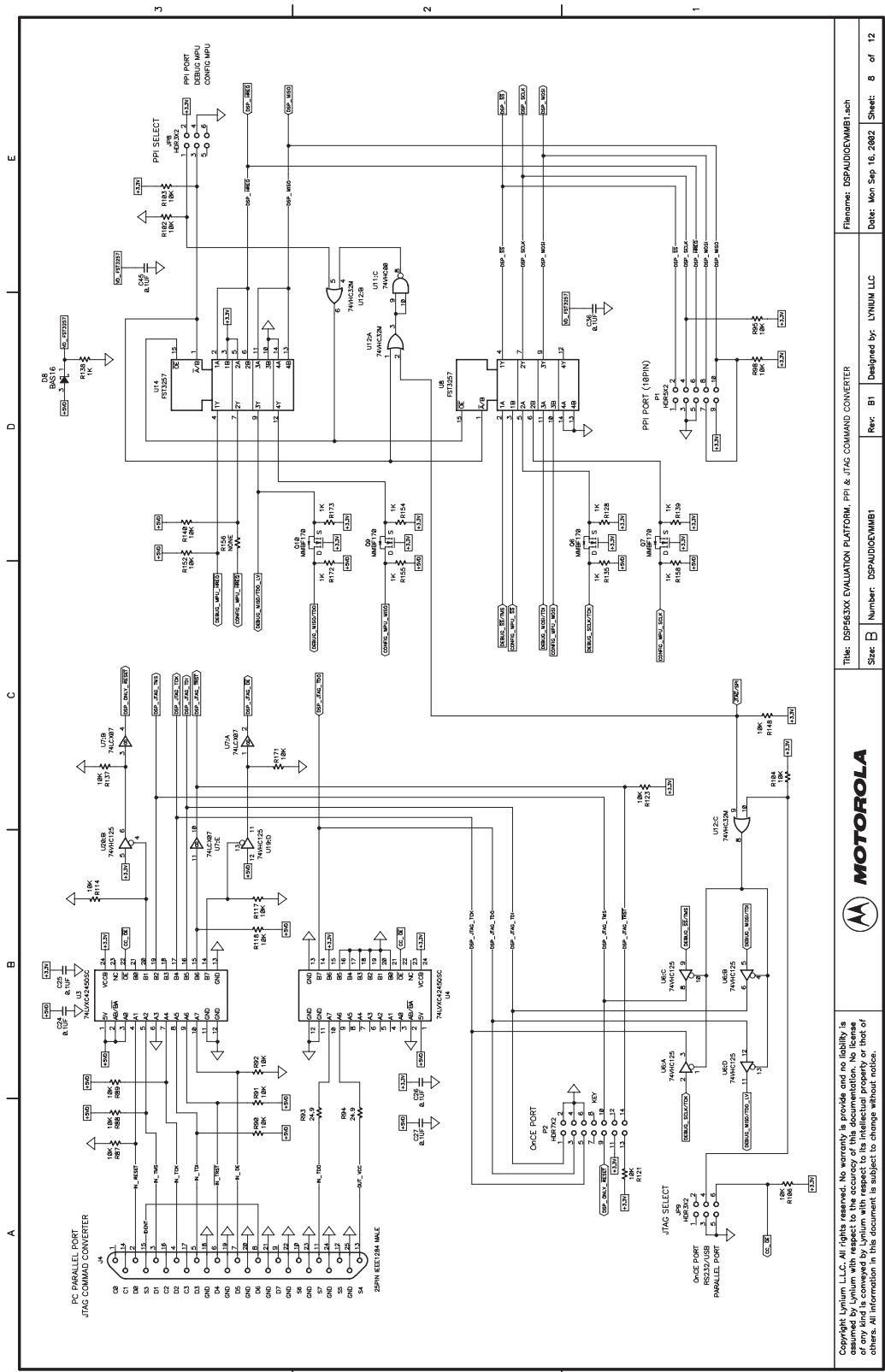

Figure A-8. Motherboard PPI and JTAG Command Converter

Copyright Lynium LLC. All rights reserved. No warranty is provided and no liability is assumed by Lynium with respect to the accuracy of this documentation. No license of any kind is conveyed by Lynium with respect to its intellectual property or that of others. All information in this document is subject to change without notice.

File Name: DSPAUDIOEVM1.sch
 Title: DSP683X EVALUATION PLATFORM: PPI & JTAG COMMAND CONVERTER
 Date: Mon Sep 16, 2002
 Sheet: 8 of 12

Rev: B1
 Number: DSPAUDIOEVM1
 Designed by: LYNIMUM LLC

MOTOROLA

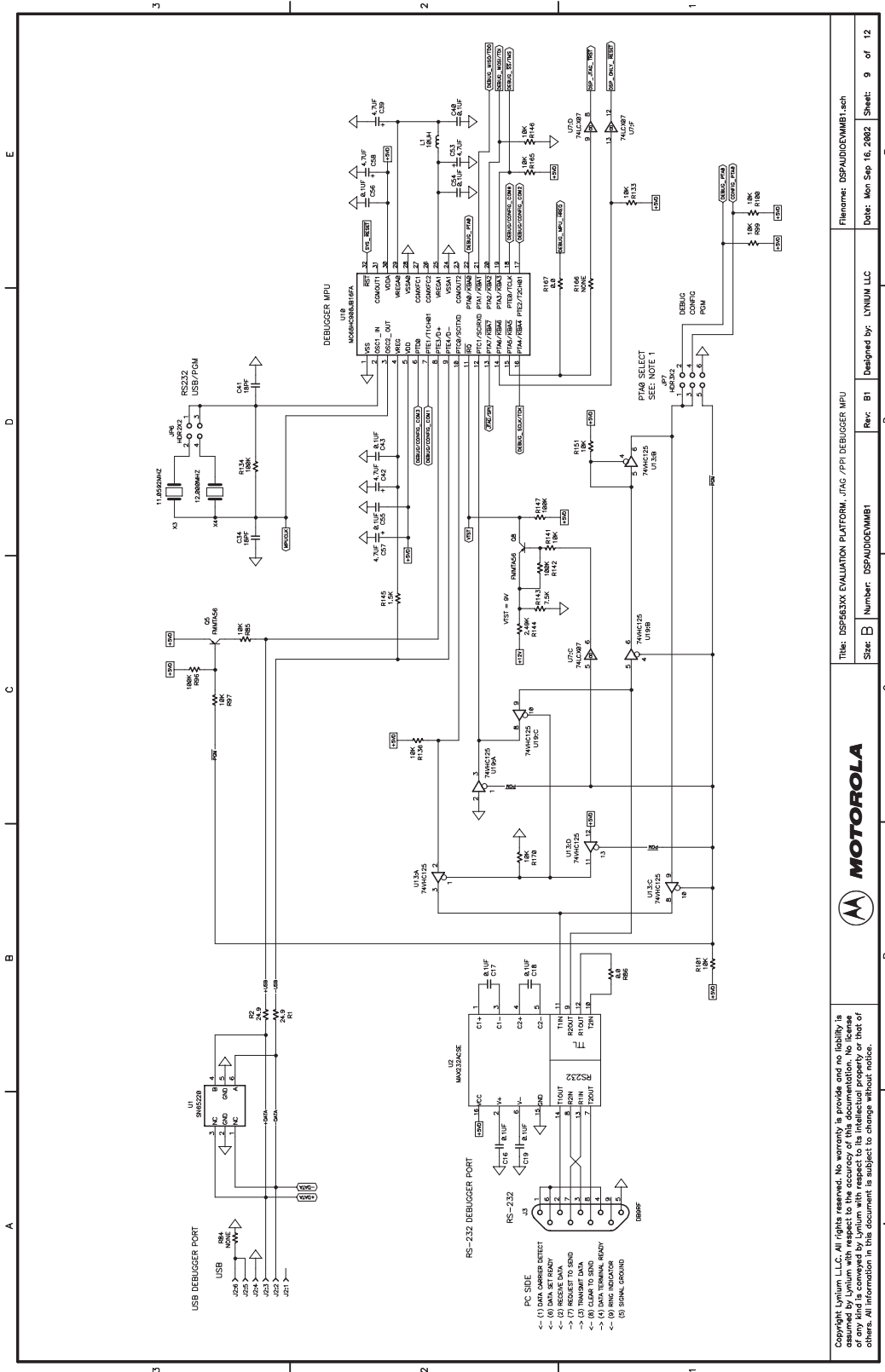

Copyright Lynium LLC. All rights reserved. No warranty is provided and no liability is assumed by Lynium with respect to the accuracy of this documentation. No license of any kind is conveyed by Lynium with respect to the intellectual property or that of others. All information in this document is subject to change without notice.

MOTOROLA

Title: DSP563XX EVALUATION PLATFORM, JTAG/PPI Debugger MPU
 Part Number: DSPAUDIOEVM01
 Rev: B1
 Date: Mon Sep 16, 2002
 Sheet: 9 of 12

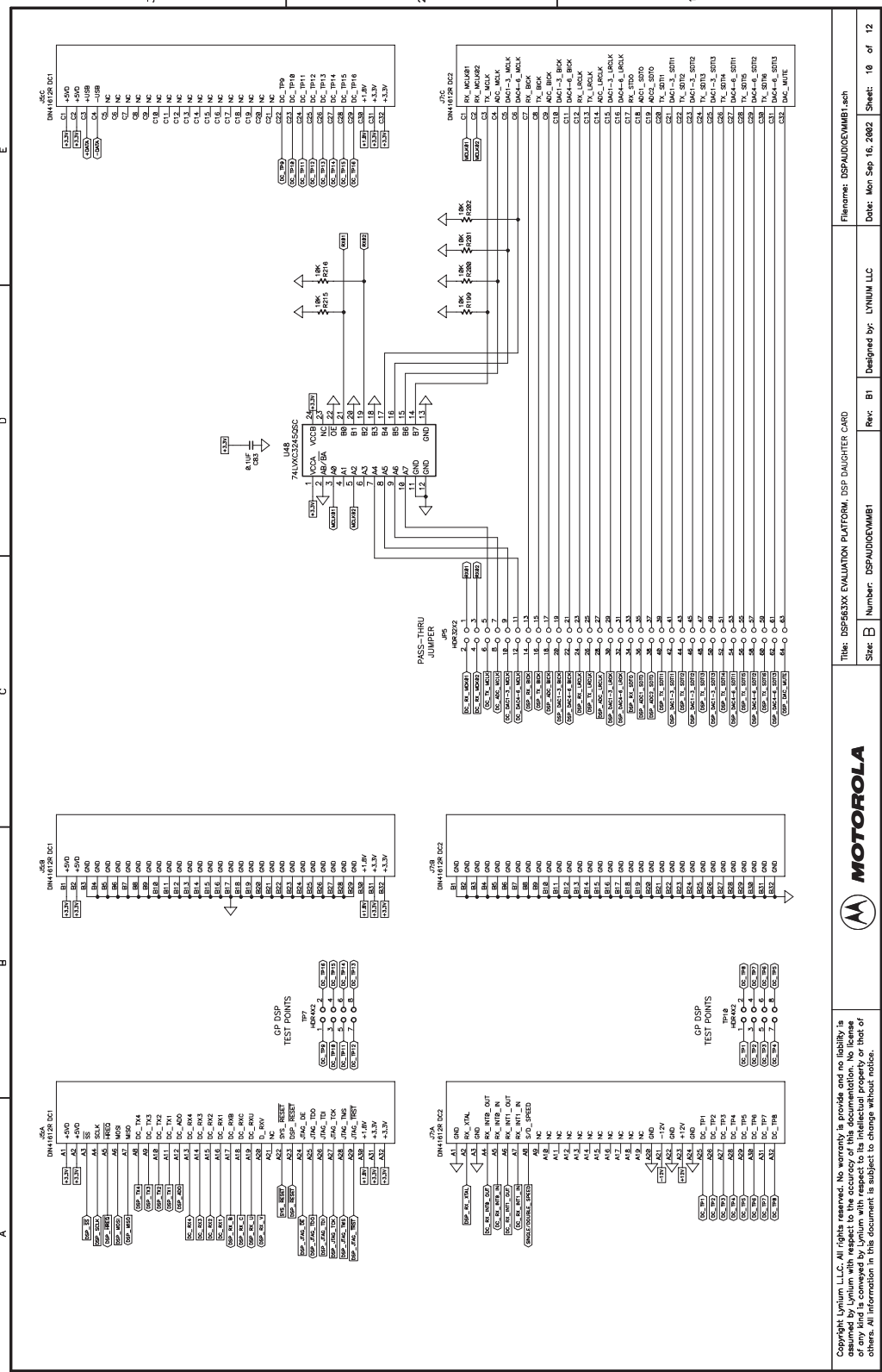

Figure A-10. Motherboard DSP Daughterboard Connectors



Copyright Lynium LLC. All rights reserved. No warranty is provided and no liability is assumed by Lynium with respect to the accuracy of this documentation. No license of any kind is conveyed by Lynium with respect to the intellectual property or that of others. All information in this document is subject to change without notice.

File Name: DSPAUDIOEVM1.sch
 Date: Mon Sep 16, 2002
 Sheet: 10 of 12

Rev: B1
 Designed by: LYNIUM LLC

State: B
 Number: DSPAUDIOEVM1

This: DSP6B3X EVALUATION PLATFORM, DSP DAUGHTER CARD

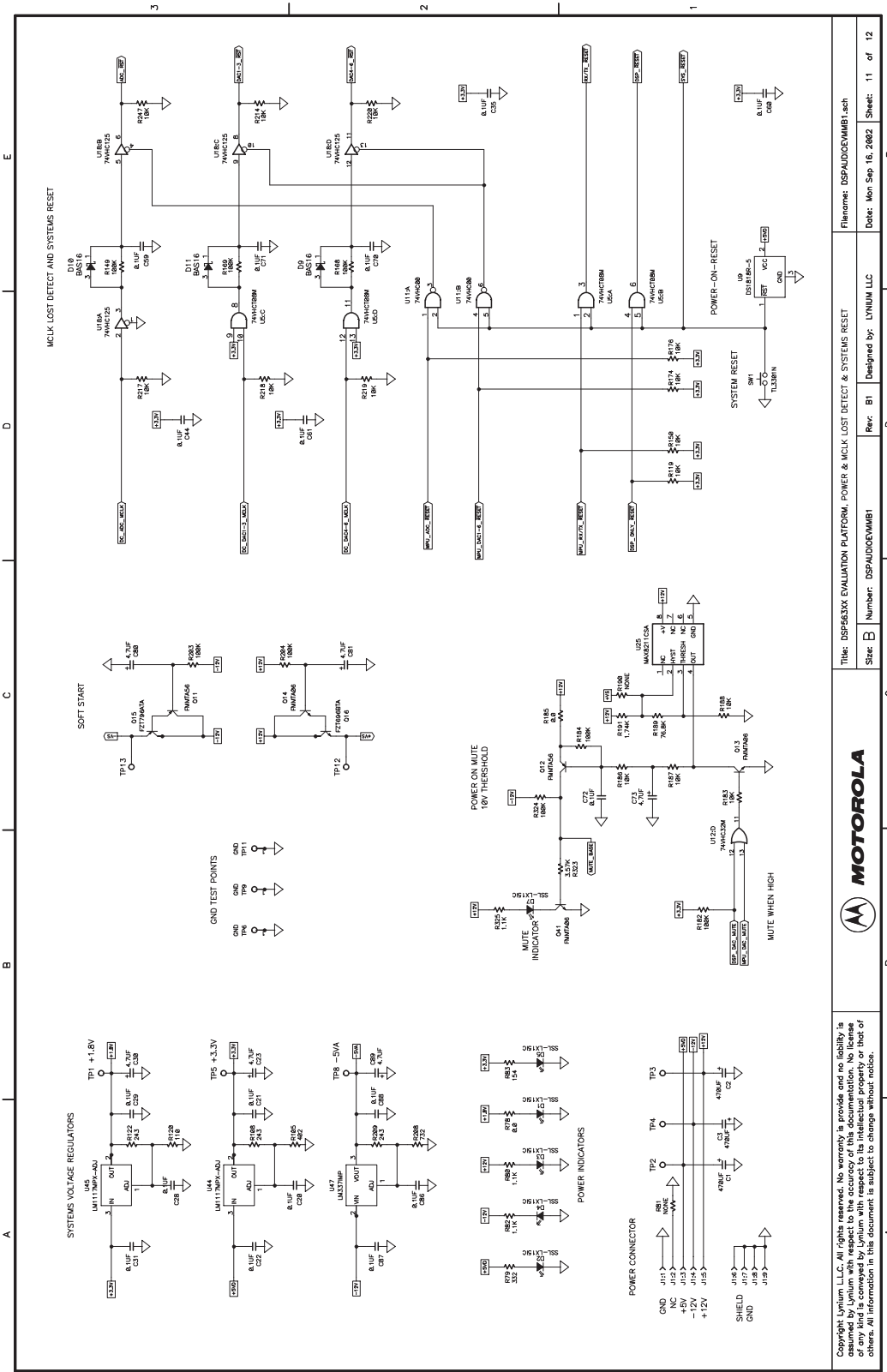

Figure A-11. Motherboard Power and MCLK Lost Detect and Systems Reset

MOTOROLA		File Name: DSPAUDIOEVM1.sch	
Title: DSP6B3X EVALUATION PLATFORM, POWER & MCLK LOST DETECT & SYSTEMS RESET		Rev: B1	
Number: DSPAUDIOEVM1		Date: Mon Sep 16, 2002	
Sheet: 11		of 12	

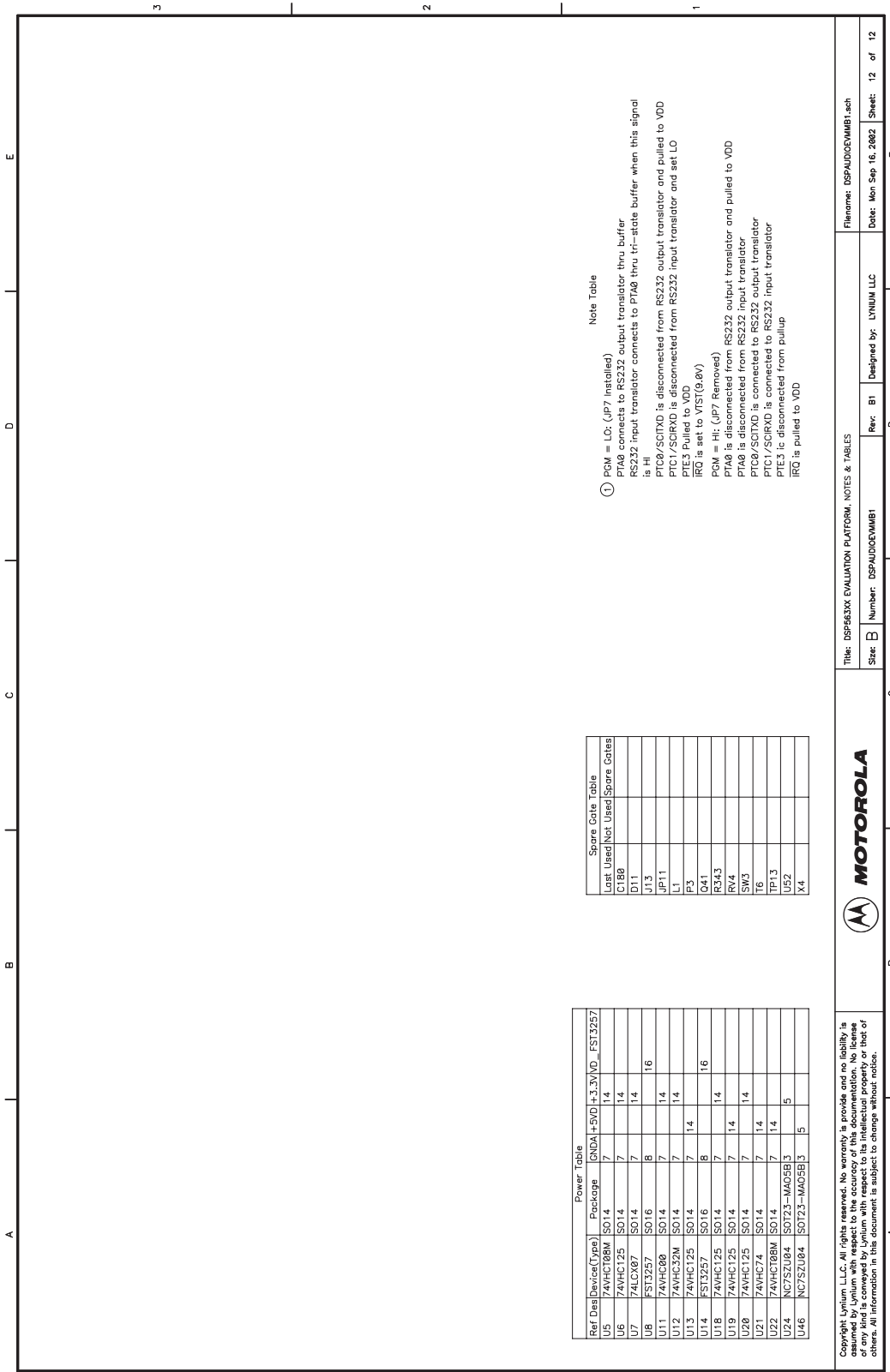

Figure A-12. Motherboard Notes and Tables

A.2 DSP5636x Daughterboard Schematics

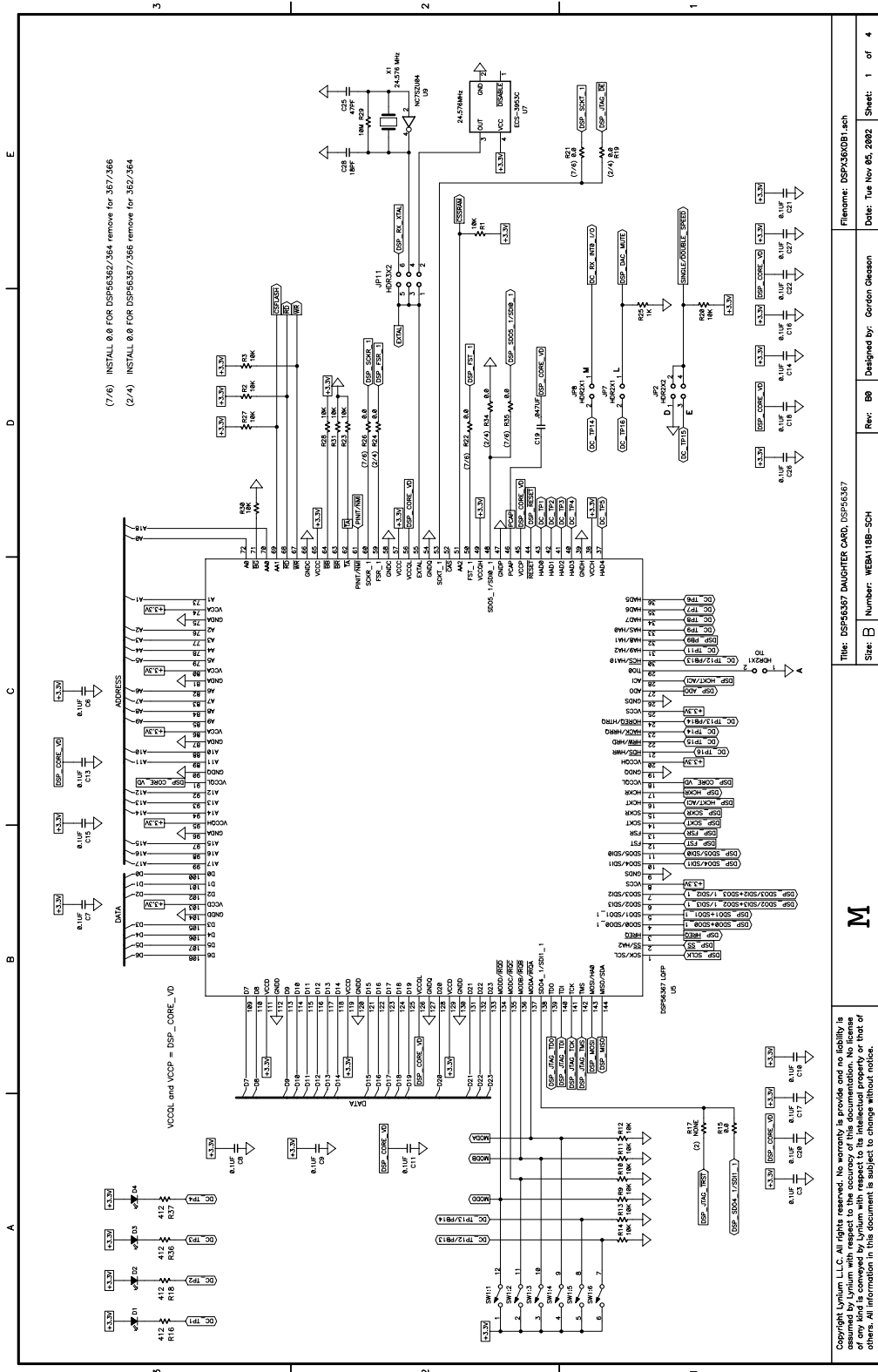

Figure A-13. DSP5636x Daughterboard DSP Connections for DSP56362/366/367

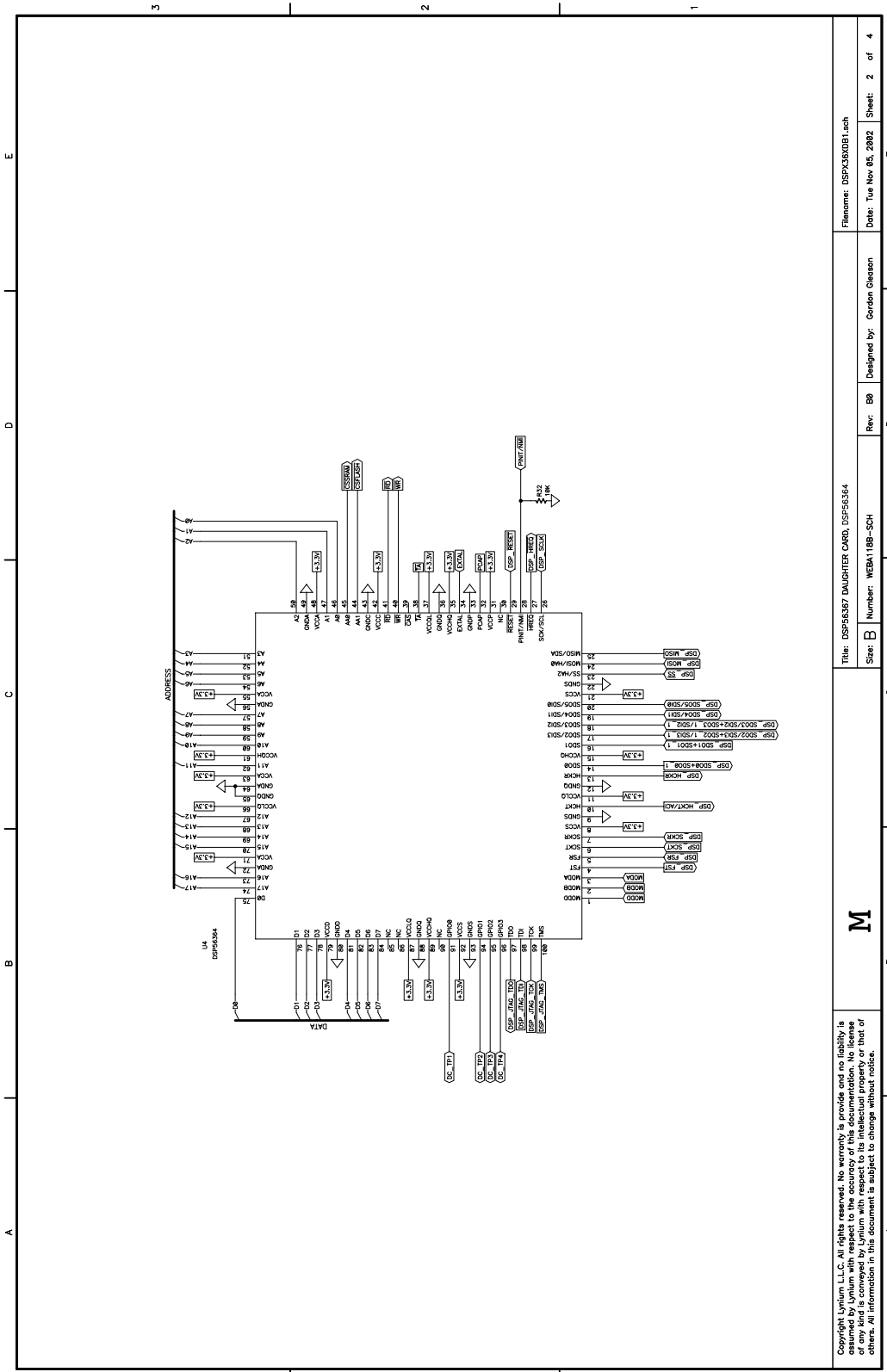

Figure A-14. DSP5636x Daughterboard DSP Connections for DSP56364

Copyright Lynium LLC. All rights reserved. No warranty is provided and no liability is assumed for any kind of error or omission. All information in this document is subject to change without notice.

M

Title: DSP56367 DAUGHTER CARD, DSP56364
 Rev: B9
 Size: 1188x1188 SCH
 Designed by: Gordon Gleason
 Date: Tue Nov 05, 2002
 Sheet: 2 of 4

Filename: DSP56367.DSP56364.sch

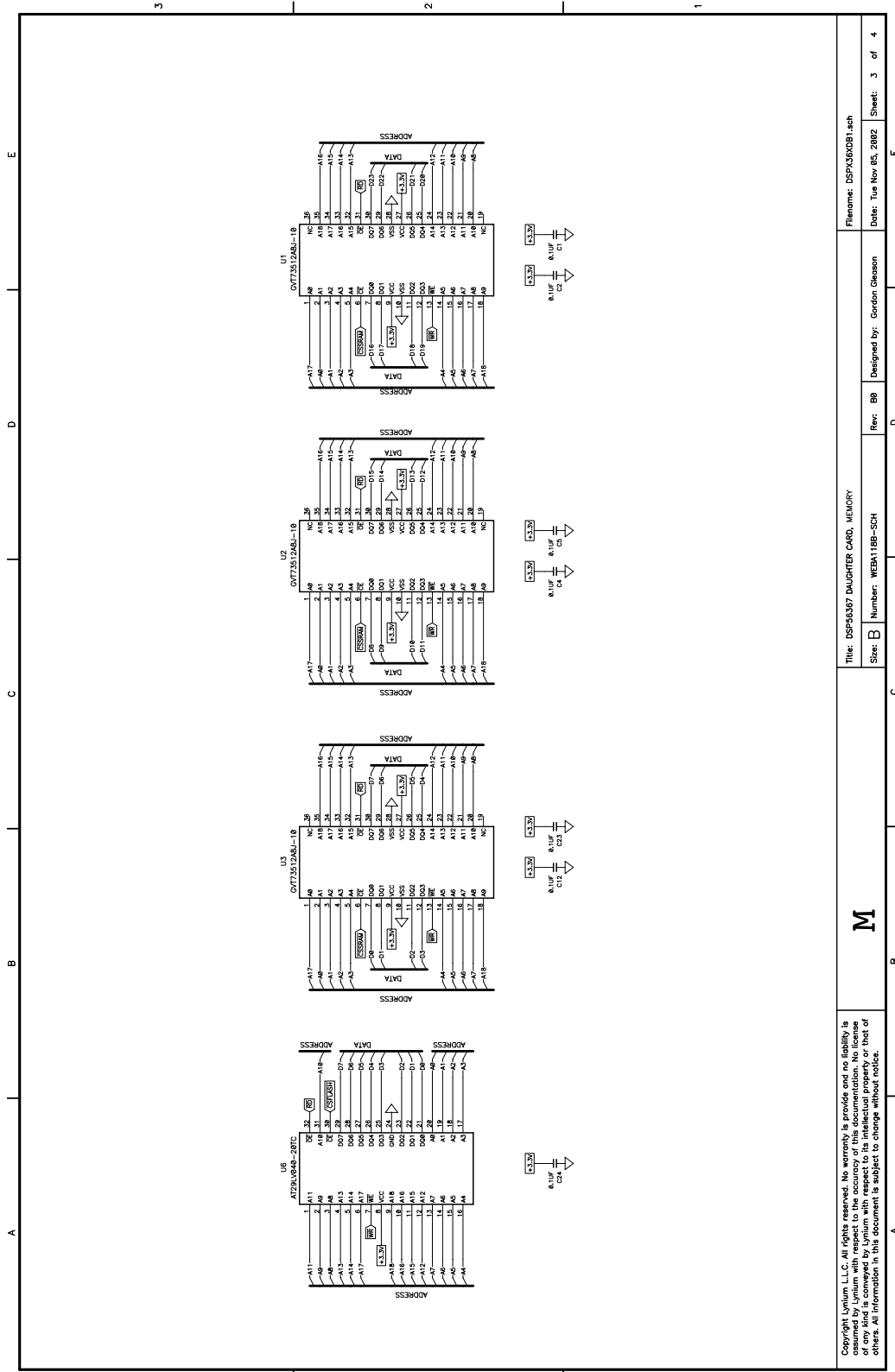

Figure A-15. DSP5636x Daughterboard External Memory

Copyright Lynium, LLC. All rights reserved. No warranty is provided and no liability is assumed by Lynium with respect to the accuracy of this documentation. No license is granted by Lynium for the use of this information for any purpose other than that of the specific product or products mentioned herein. All information in this document is subject to change without notice.		M		Title: DSP56367 DAUGHTER CARD, MEMORY		Filename: DSP56367B1.sch	
Size: B	Number: WEBM118B-SCH	Rev: B8	Designed by: Gordon Gleason	Date: Tue Nov 05, 2002	Sheet: 3	of 4	

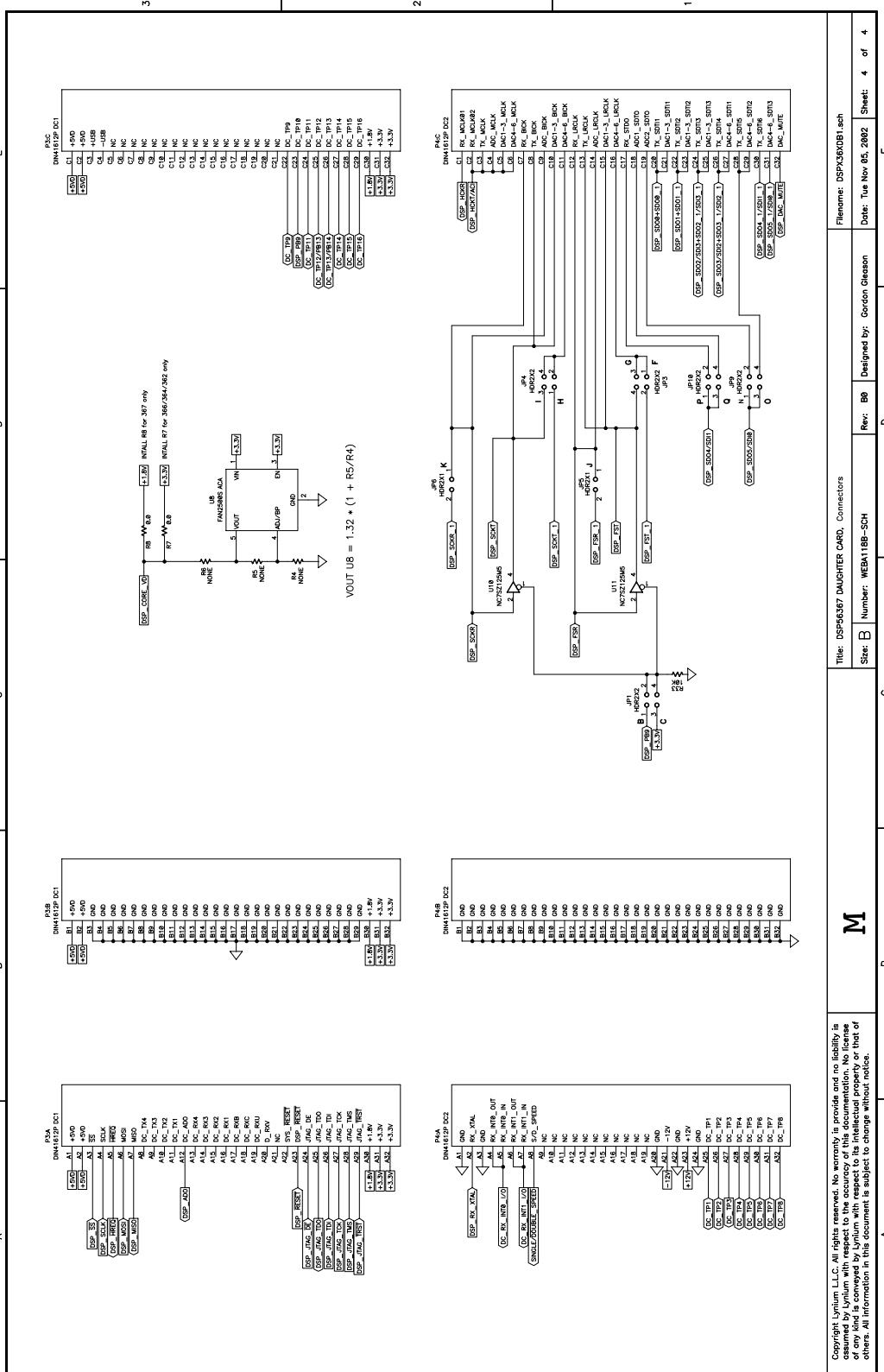

Figure A-16. DSP5636x Daughterboard Connectors

A.3 DSP56371 Daughterboard Schematics

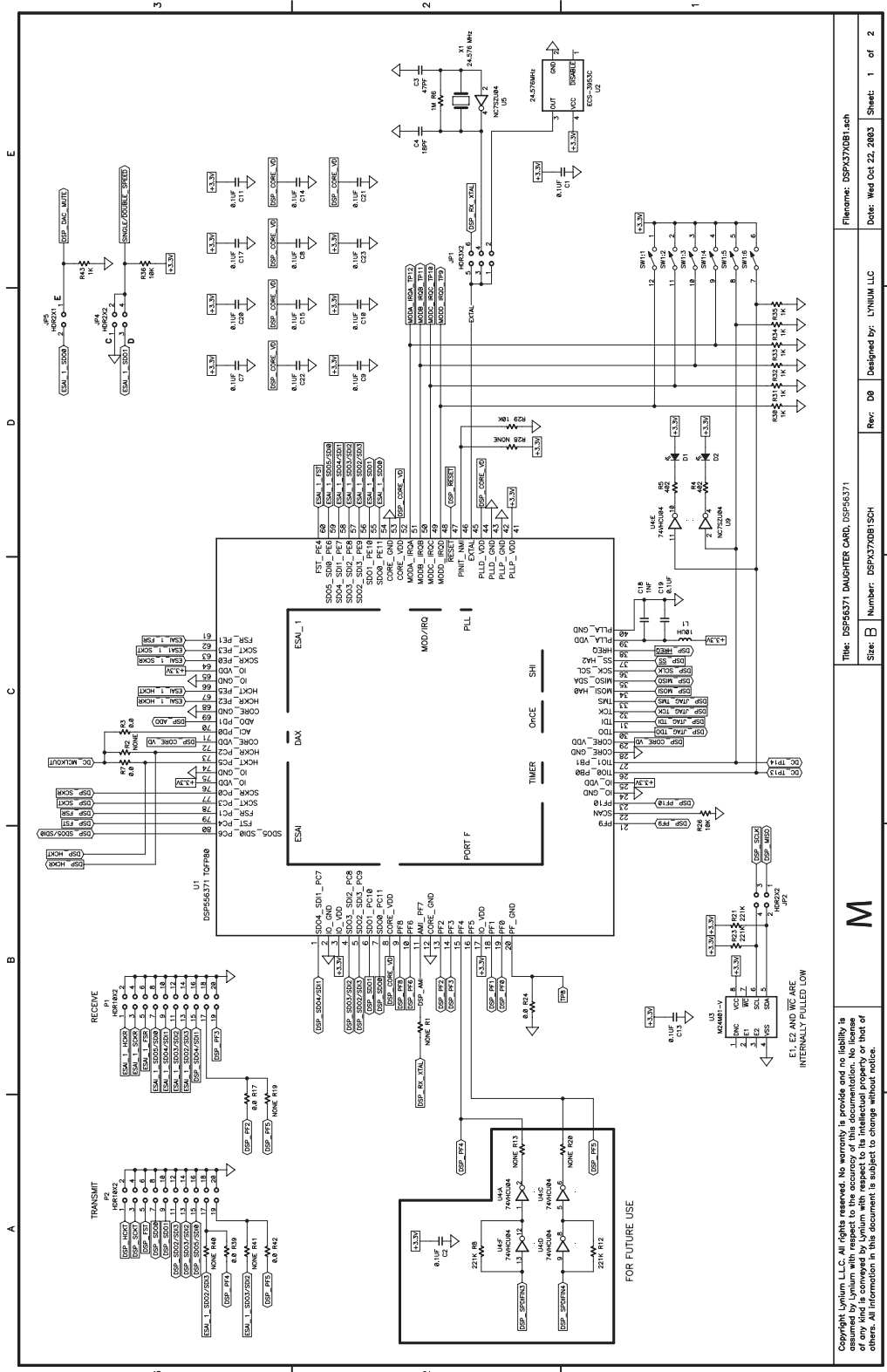

Figure A-17. DSP56371 Daughterboard DSP Connections

Title: DSP56371 DAUGHTER CARD, DSP56371		Filename: DSP56371.DSP56371	
Rev: D8	Designed by: LYNNUM LLC	Date: Wed Oct 22, 2003	Sheet: 1 of 2
Size: B		Number: DSP56371.DSP56371	

Copyright Lynnum LLC. All rights reserved. No warranty is provided and no liability is assumed for any errors or omissions in this document. The information contained herein is the property of Lynnum with respect to its intellectual property or that of others. All information in this document is subject to change without notice.

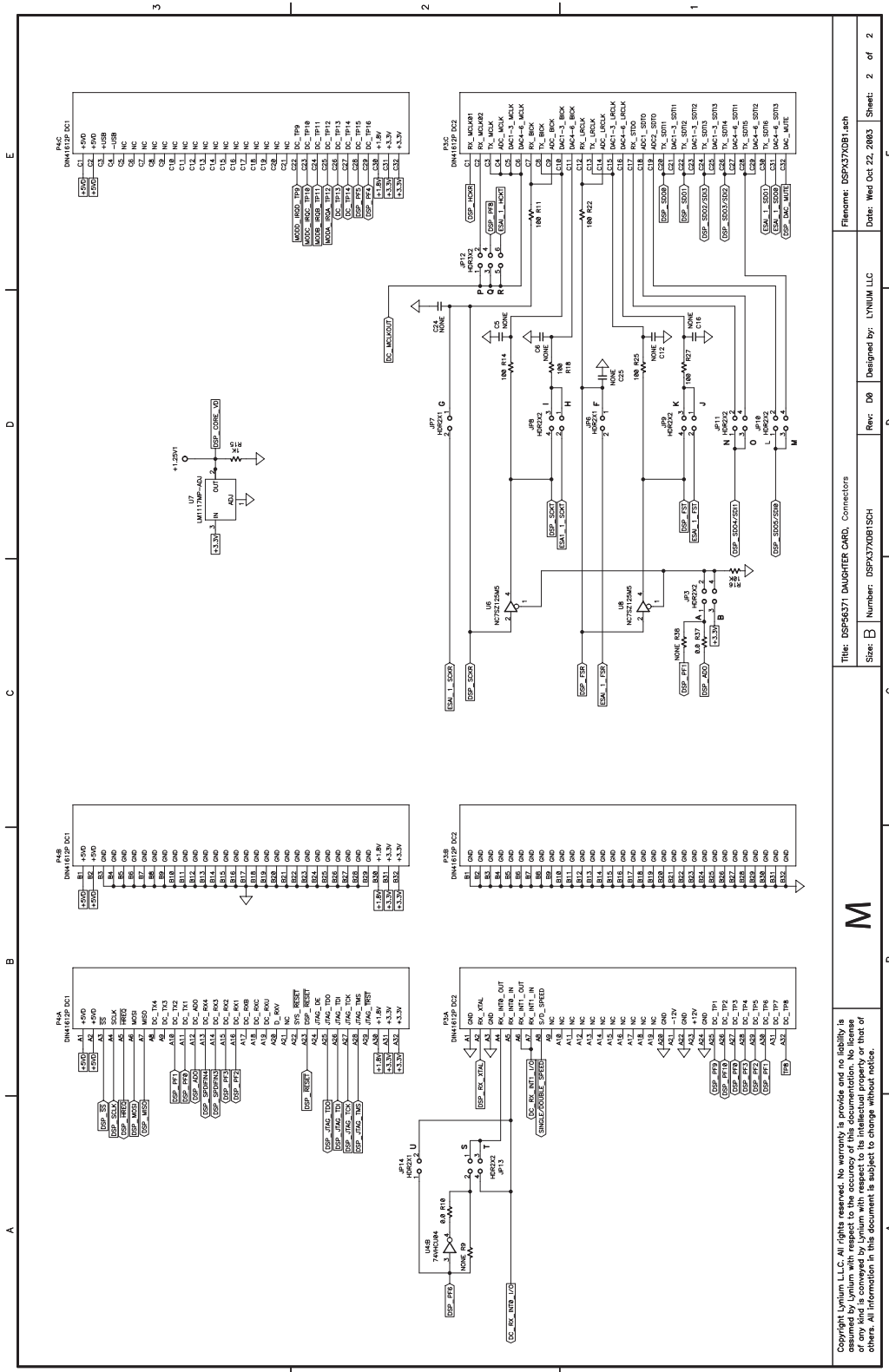

Figure A-18. DSP56371 Daughterboard Connectors

A.4 DSP56374 Daughterboard Schematics

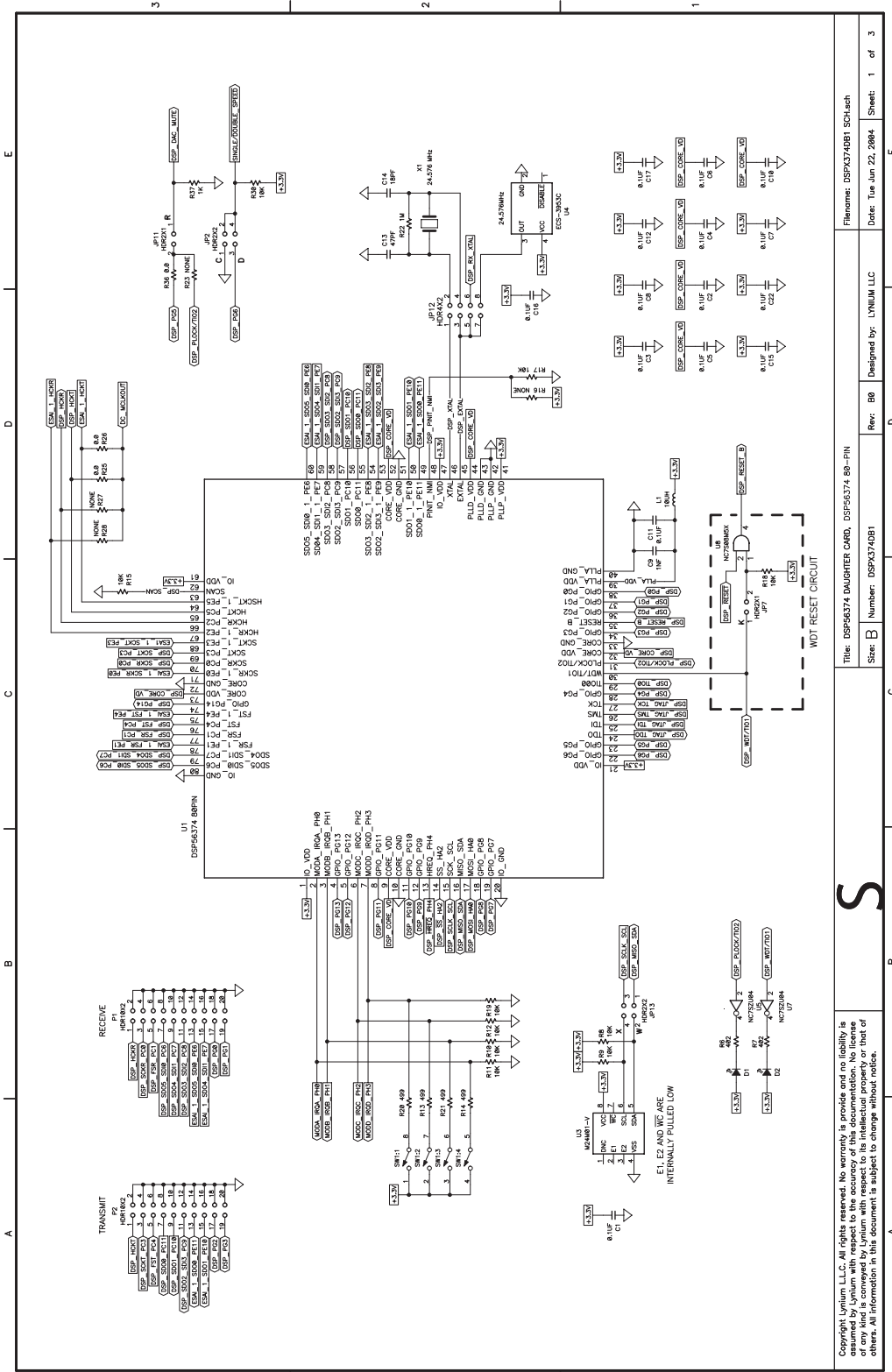

Figure A-19. DSP56374 Daughterboard 80-pin DSP Connections

Title: DSP56374 DAUGHTER CARD, DSP56374 80-PIN		Filename: DSP56374DB1 SCH.sch
Size: B	Number: DSP56374DB1	Design by: LYNIUM LLC
Rev: B8	Date: Tue Jun 22, 2004	
Sheet: 1 of 3		

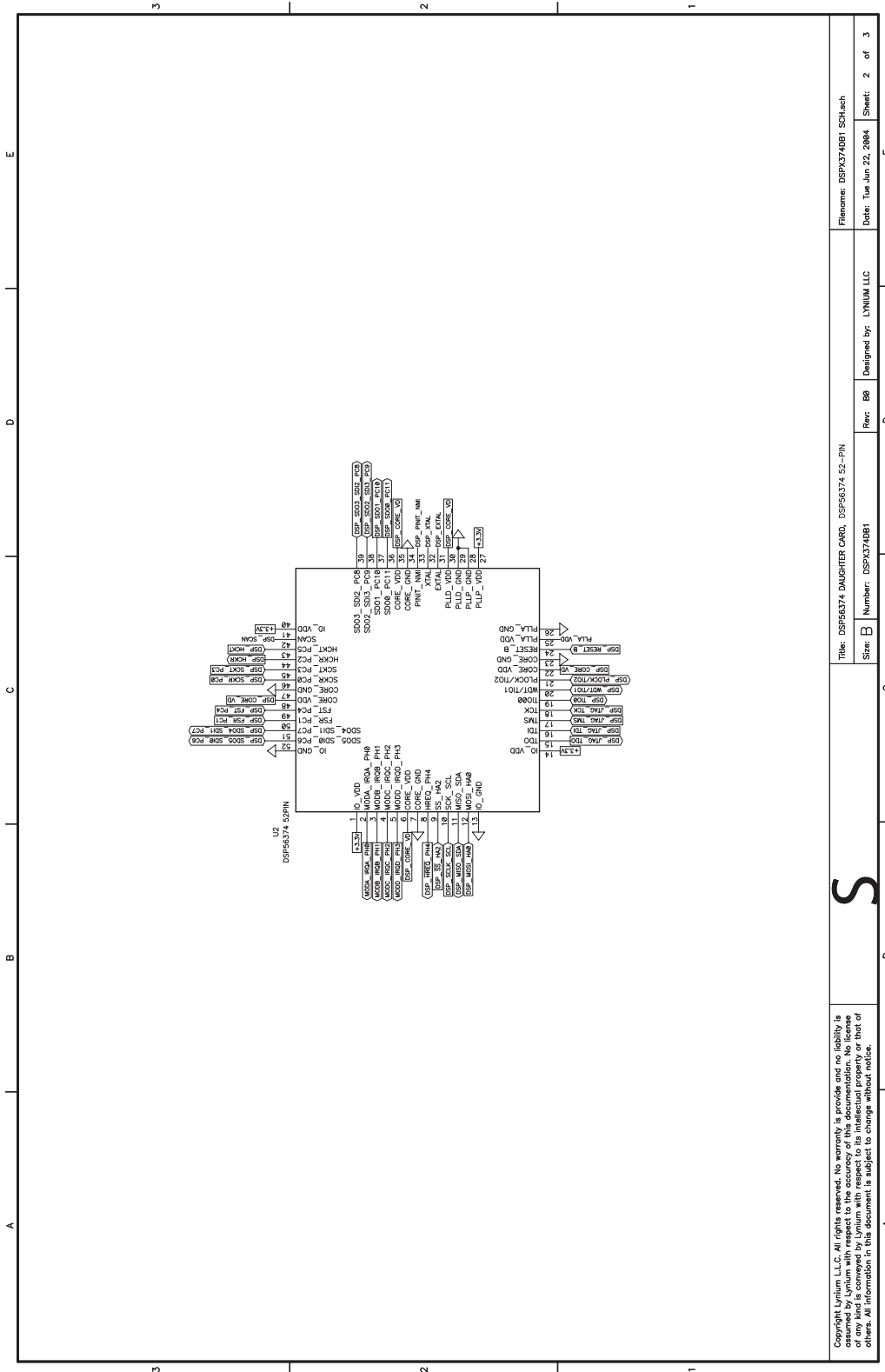
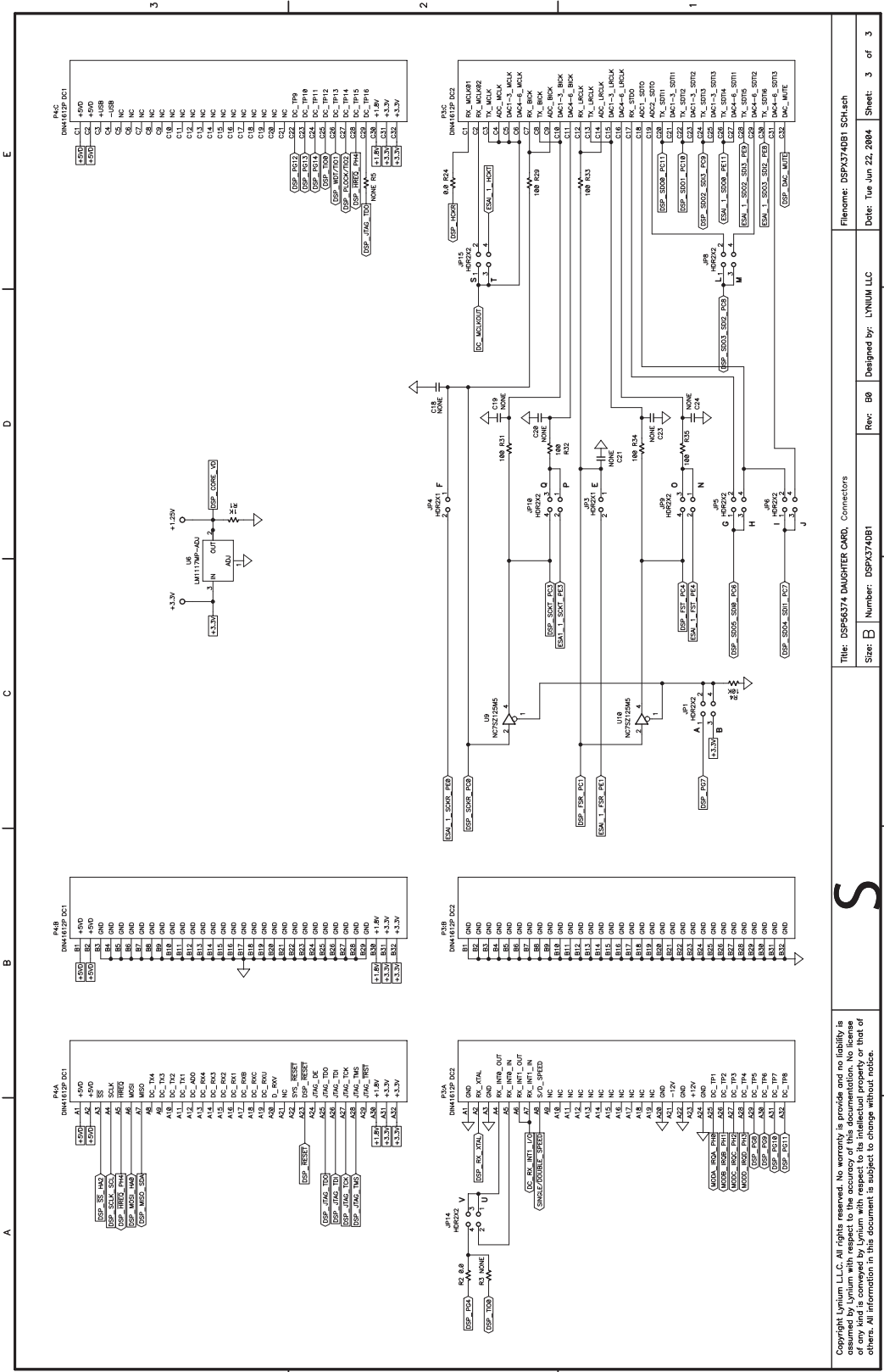

Figure A-20. DSP56374 Daughterboard 52-pin DSP Connections



Title: DSP56374 DAUGHTER CARD, Connectors		Rev: B0	Designed by: LYNIUM LLC	Sheet: 3 of 3
Filename: DSP563740B1 SCH.sch		Date: Tue Jun 22, 2004		

Figure A-21. DSP56374 Daughterboard Connectors

Appendix B

EVM Bill of Materials

Table B-1. EVM Bill of Materials

RefDes	Value	Part Number	Description	Manufacturer
C1	470UF	EEV-FC1E471P	Aluminum Electrolytic Capacitor/FC Series 470UF 25V	Panasonic
C2	470UF	EEV-FC1E471P	Aluminum Electrolytic Capacitor/FC Series 470UF 25V	Panasonic
C3	470UF	EEV-FC1E471P	Aluminum Electrolytic Capacitor/FC Series 470UF 25V	Panasonic
C4	150PF	C080COG101-151JNE	150 PF 5% COG 0805 100V Ceramic Chip Capacitor	Venkel
C5	150PF	C080COG101-151JNE	150 PF 5% COG 0805 100V Ceramic Chip Capacitor	Venkel
C6	150PF	C080COG101-151JNE	150 PF 5% COG 0805 100V Ceramic Chip Capacitor	Venkel
C7	150PF	C080COG101-151JNE	150 PF 5% COG 0805 100V Ceramic Chip Capacitor	Venkel
C8	150PF	C080COG101-151JNE	150 PF 5% COG 0805 100V Ceramic Chip Capacitor	Venkel
C9	150PF	C080COG101-151JNE	150 PF 5% COG 0805 100V Ceramic Chip Capacitor	Venkel
C10	150PF	C080COG101-151JNE	150 PF 5% COG 0805 100V Ceramic Chip Capacitor	Venkel
C11	150PF	C080COG101-151JNE	150 PF 5% COG 0805 100V Ceramic Chip Capacitor	Venkel
C12	150PF	C080COG101-151JNE	150 PF 5% COG 0805 100V Ceramic Chip Capacitor	Venkel
C13	150PF	C080COG101-151JNE	150 PF 5% COG 0805 100V Ceramic Chip Capacitor	Venkel
C14	150PF	C080COG101-151JNE	150 PF 5% COG 0805 100V Ceramic Chip Capacitor	Venkel
C15	150PF	C080COG101-151JNE	150 PF 5% COG 0805 100V Ceramic Chip Capacitor	Venkel
C16	0.1UF	C0805X7R500-104KNE	0.1UF10% X7R 0805 50V Ceramic Chip Capacitor	Venkel
C17	0.1UF	C0805X7R500-104KNE	0.1UF10% X7R 0805 50V Ceramic Chip Capacitor	Venkel
C18	0.1UF	C0805X7R500-104KNE	0.1UF10% X7R 0805 50V Ceramic Chip Capacitor	Venkel
C19	0.1UF	C0805X7R500-104KNE	0.1UF10% X7R 0805 50V Ceramic Chip Capacitor	Venkel
C20	0.1UF	C0805X7R500-104KNE	0.1UF10% X7R 0805 50V Ceramic Chip Capacitor	Venkel
C21	0.1UF	C0805X7R500-104KNE	0.1UF10% X7R 0805 50V Ceramic Chip Capacitor	Venkel
C22	0.1UF	C0805X7R500-104KNE	0.1UF10% X7R 0805 50V Ceramic Chip Capacitor	Venkel
C23	4.7UF	T491A475M016AS	4.7UF Tantalum Chip Capacitor 16V 3216	Kemet
C24	0.1UF	C0805X7R500-104KNE	0.1UF10% X7R 0805 50V Ceramic Chip Capacitor	Venkel
C25	0.1UF	C0805X7R500-104KNE	0.1UF10% X7R 0805 50V Ceramic Chip Capacitor	Venkel
C26	0.1UF	C0805X7R500-104KNE	0.1UF10% X7R 0805 50V Ceramic Chip Capacitor	Venkel
C27	0.1UF	C0805X7R500-104KNE	0.1UF10% X7R 0805 50V Ceramic Chip Capacitor	Venkel
C28	0.1UF	C0805X7R500-104KNE	0.1UF10% X7R 0805 50V Ceramic Chip Capacitor	Venkel
C29	0.1UF	C0805X7R500-104KNE	0.1UF10% X7R 0805 50V Ceramic Chip Capacitor	Venkel
C30	4.7UF	T491A475M016AS	4.7UF Tantalum Chip Capacitor 16V 3216	Kemet
C31	0.1UF	C0805X7R500-104KNE	0.1UF10% X7R 0805 50V Ceramic Chip Capacitor	Venkel
C32	0.1UF	C0805X7R500-104KNE	0.1UF10% X7R 0805 50V Ceramic Chip Capacitor	Venkel
C33	0.1UF	C0805X7R500-104KNE	0.1UF10% X7R 0805 50V Ceramic Chip Capacitor	Venkel
C34	18PF	C080COG500-180JNE	18 PF 5% COG 0805 50V Ceramic Chip Capacitor	Venkel
C35	0.1UF	C0805X7R500-104KNE	0.1UF10% X7R 0805 50V Ceramic Chip Capacitor	Venkel
C36	0.1UF	C0805X7R500-104KNE	0.1UF10% X7R 0805 50V Ceramic Chip Capacitor	Venkel
C37	0.1UF	C0805X7R500-104KNE	0.1UF10% X7R 0805 50V Ceramic Chip Capacitor	Venkel
C38	0.1UF	C0805X7R500-104KNE	0.1UF10% X7R 0805 50V Ceramic Chip Capacitor	Venkel
C39	4.7UF	T491A475M016AS	4.7UF Tantalum Chip Capacitor 16V 3216	Kemet
C40	0.1UF	C0805X7R500-104KNE	0.1UF10% X7R 0805 50V Ceramic Chip Capacitor	Venkel
C41	18PF	C080COG500-180JNE	18 PF 5% COG 0805 50V Ceramic Chip Capacitor	Venkel
C42	4.7UF	T491A475M016AS	4.7UF Tantalum Chip Capacitor 16V 3216	Kemet
C43	0.1UF	C0805X7R500-104KNE	0.1UF10% X7R 0805 50V Ceramic Chip Capacitor	Venkel
C44	0.1UF	C0805X7R500-104KNE	0.1UF10% X7R 0805 50V Ceramic Chip Capacitor	Venkel
C45	0.1UF	C0805X7R500-104KNE	0.1UF10% X7R 0805 50V Ceramic Chip Capacitor	Venkel
C46	18PF	C080COG500-180JNE	18 PF 5% COG 0805 50V Ceramic Chip Capacitor	Venkel

Table B-1. EVM Bill of Materials

C47	0.1UF	C0805X7R500-104KNE	0.1UF10% X7R 0805 50V Ceramic Chip Capacitor	Venkel
C48	0.1UF	C0805X7R500-104KNE	0.1UF10% X7R 0805 50V Ceramic Chip Capacitor	Venkel
C49	0.1UF	C0805X7R500-104KNE	0.1UF10% X7R 0805 50V Ceramic Chip Capacitor	Venkel
C50	0.1UF	C0805X7R500-104KNE	0.1UF10% X7R 0805 50V Ceramic Chip Capacitor	Venkel
C51	0.1UF	C0805X7R500-104KNE	0.1UF10% X7R 0805 50V Ceramic Chip Capacitor	Venkel
C52	0.1UF	C0805X7R500-104KNE	0.1UF10% X7R 0805 50V Ceramic Chip Capacitor	Venkel
C53	4.7UF	T491A475M016AS	4.7UF Tantalum Chip Capacitor 16V 3216	Kemet
C54	0.1UF	C0805X7R500-104KNE	0.1UF10% X7R 0805 50V Ceramic Chip Capacitor	Venkel
C55	0.1UF	C0805X7R500-104KNE	0.1UF10% X7R 0805 50V Ceramic Chip Capacitor	Venkel
C56	0.1UF	C0805X7R500-104KNE	0.1UF10% X7R 0805 50V Ceramic Chip Capacitor	Venkel
C57	4.7UF	T491A475M016AS	4.7UF Tantalum Chip Capacitor 16V 3216	Kemet
C58	4.7UF	T491A475M016AS	4.7UF Tantalum Chip Capacitor 16V 3216	Kemet
C59	0.1UF	C0805X7R500-104KNE	0.1UF10% X7R 0805 50V Ceramic Chip Capacitor	Venkel
C60	0.1UF	C0805X7R500-104KNE	0.1UF10% X7R 0805 50V Ceramic Chip Capacitor	Venkel
C61	0.1UF	C0805X7R500-104KNE	0.1UF10% X7R 0805 50V Ceramic Chip Capacitor	Venkel
C62	47PF	C080COG101-470JNE	47 PF 5% COG 0805 100V Ceramic Chip Capacitor	Venkel
C63	0.1UF	C0805X7R500-104KNE	0.1UF10% X7R 0805 50V Ceramic Chip Capacitor	Venkel
C64	0.1UF	C0805X7R500-104KNE	0.1UF10% X7R 0805 50V Ceramic Chip Capacitor	Venkel
C65	47PF	C080COG101-470JNE	47 PF 5% COG 0805 100V Ceramic Chip Capacitor	Venkel
C66	18PF	C080COG500-180JNE	18 PF 5% COG 0805 50V Ceramic Chip Capacitor	Venkel
C67	47PF	C080COG101-470JNE	47 PF 5% COG 0805 100V Ceramic Chip Capacitor	Venkel
C68	47PF	C080COG101-470JNE	47 PF 5% COG 0805 100V Ceramic Chip Capacitor	Venkel
C69	7PF	C080COG500-7R0JNE	7 PF 5% COG 0805 50V Ceramic Chip Capacitor	Venkel
C70	0.1UF	C0805X7R500-104KNE	0.1UF10% X7R 0805 50V Ceramic Chip Capacitor	Venkel
C71	0.1UF	C0805X7R500-104KNE	0.1UF10% X7R 0805 50V Ceramic Chip Capacitor	Venkel
C72	0.1UF	C0805X7R500-104KNE	0.1UF10% X7R 0805 50V Ceramic Chip Capacitor	Venkel
C73	4.7UF	T491A475M016AS	4.7UF Tantalum Chip Capacitor 16V 3216	Kemet
C74	0.1UF	C0805X7R500-104KNE	0.1UF10% X7R 0805 50V Ceramic Chip Capacitor	Venkel
C75	0.1UF	C0805X7R500-104KNE	0.1UF10% X7R 0805 50V Ceramic Chip Capacitor	Venkel
C76	0.1UF	C0805X7R500-104KNE	0.1UF10% X7R 0805 50V Ceramic Chip Capacitor	Venkel
C77	0.1UF	C0805X7R500-104KNE	0.1UF10% X7R 0805 50V Ceramic Chip Capacitor	Venkel
C78	47PF	C080COG101-470JNE	47 PF 5% COG 0805 100V Ceramic Chip Capacitor	Venkel
C79	47PF	C080COG101-470JNE	47 PF 5% COG 0805 100V Ceramic Chip Capacitor	Venkel
C80	4.7UF	T491A475M016AS	4.7UF Tantalum Chip Capacitor 16V 3216	Kemet
C81	4.7UF	T491A475M016AS	4.7UF Tantalum Chip Capacitor 16V 3216	Kemet
C82	0.1UF	C0805X7R500-104KNE	0.1UF10% X7R 0805 50V Ceramic Chip Capacitor	Venkel
C83	0.1UF	C0805X7R500-104KNE	0.1UF10% X7R 0805 50V Ceramic Chip Capacitor	Venkel
C84	0.1UF	C0805X7R500-104KNE	0.1UF10% X7R 0805 50V Ceramic Chip Capacitor	Venkel
C85	0.1UF	C0805X7R500-104KNE	0.1UF10% X7R 0805 50V Ceramic Chip Capacitor	Venkel
C86	0.1UF	C0805X7R500-104KNE	0.1UF10% X7R 0805 50V Ceramic Chip Capacitor	Venkel
C87	0.1UF	C0805X7R500-104KNE	0.1UF10% X7R 0805 50V Ceramic Chip Capacitor	Venkel
C88	0.1UF	C0805X7R500-104KNE	0.1UF10% X7R 0805 50V Ceramic Chip Capacitor	Venkel
C89	4.7UF	T491A475M016AS	4.7UF Tantalum Chip Capacitor 16V 3216	Kemet
C90	0.1UF	C0805X7R500-104KNE	0.1UF10% X7R 0805 50V Ceramic Chip Capacitor	Venkel
C91	NONE		Do Not Install	
C92	NONE		Do Not Install	
C93	0.1UF	C0805X7R500-104KNE	0.1UF10% X7R 0805 50V Ceramic Chip Capacitor	Venkel
C94	4.7UF	T491A475M016AS	4.7UF Tantalum Chip Capacitor 16V 3216	Kemet
C95	4.7UF	T491A475M016AS	4.7UF Tantalum Chip Capacitor 16V 3216	Kemet
C96	0.1UF	C0805X7R500-104KNE	0.1UF10% X7R 0805 50V Ceramic Chip Capacitor	Venkel
C97	4.7UF	T491A475M016AS	4.7UF Tantalum Chip Capacitor 16V 3216	Kemet

DSPAUDIOEVM Users Guide, Rev. 2.4

Table B-1. EVM Bill of Materials

C98	0.1UF	C0805X7R500-104KNE	0.1UF10% X7R 0805 50V Ceramic Chip Capacitor	Venkel
C99	0.1UF	C0805X7R500-104KNE	0.1UF10% X7R 0805 50V Ceramic Chip Capacitor	Venkel
C100	4.7UF	T491A475M016AS	4.7UF Tantalum Chip Capacitor 16V 3216	Kemet
C101	0.1UF	C0805X7R500-104KNE	0.1UF10% X7R 0805 50V Ceramic Chip Capacitor	Venkel
C102	0.1UF	C0805X7R500-104KNE	0.1UF10% X7R 0805 50V Ceramic Chip Capacitor	Venkel
C103	4.7UF	T491A475M016AS	4.7UF Tantalum Chip Capacitor 16V 3216	Kemet
C104	4.7UF	T491A475M016AS	4.7UF Tantalum Chip Capacitor 16V 3216	Kemet
C105	0.1UF	C0805X7R500-104KNE	0.1UF10% X7R 0805 50V Ceramic Chip Capacitor	Venkel
C106	0.1UF	C0805X7R500-104KNE	0.1UF10% X7R 0805 50V Ceramic Chip Capacitor	Venkel
C107	4.7UF	T491A475M016AS	4.7UF Tantalum Chip Capacitor 16V 3216	Kemet
C108	4.7UF	T491A475M016AS	4.7UF Tantalum Chip Capacitor 16V 3216	Kemet
C109	0.1UF	C0805X7R500-104KNE	0.1UF10% X7R 0805 50V Ceramic Chip Capacitor	Venkel
C110	0.1UF	C0805X7R500-104KNE	0.1UF10% X7R 0805 50V Ceramic Chip Capacitor	Venkel
C111	4.7UF	T491A475M016AS	4.7UF Tantalum Chip Capacitor 16V 3216	Kemet
C112	470PF	C080COG101-471JNE	470 PF 5% COG 0805 100V Ceramic Chip Capacitor	Venkel
C113	0.1UF	C0805X7R500-104KNE	0.1UF10% X7R 0805 50V Ceramic Chip Capacitor	Venkel
C114	0.1UF	C0805X7R500-104KNE	0.1UF10% X7R 0805 50V Ceramic Chip Capacitor	Venkel
C115	0.1UF	C0805X7R500-104KNE	0.1UF10% X7R 0805 50V Ceramic Chip Capacitor	Venkel
C116	0.1UF	C0805X7R500-104KNE	0.1UF10% X7R 0805 50V Ceramic Chip Capacitor	Venkel
C117	0.1UF	C0805X7R500-104KNE	0.1UF10% X7R 0805 50V Ceramic Chip Capacitor	Venkel
C118	4.7UF	T491A475M016AS	4.7UF Tantalum Chip Capacitor 16V 3216	Kemet
C119	470PF	C080COG101-471JNE	470 PF 5% COG 0805 100V Ceramic Chip Capacitor	Venkel
C120	0.1UF	C0805X7R500-104KNE	0.1UF10% X7R 0805 50V Ceramic Chip Capacitor	Venkel
C121	150PF	C080COG101-151JNE	150 PF 5% COG 0805 100V Ceramic Chip Capacitor	Venkel
C122	150PF	C080COG101-151JNE	150 PF 5% COG 0805 100V Ceramic Chip Capacitor	Venkel
C123	150PF	C080COG101-151JNE	150 PF 5% COG 0805 100V Ceramic Chip Capacitor	Venkel
C124	150PF	C080COG101-151JNE	150 PF 5% COG 0805 100V Ceramic Chip Capacitor	Venkel
C125	0.1UF	C0805X7R500-104KNE	0.1UF10% X7R 0805 50V Ceramic Chip Capacitor	Venkel
C126	0.1UF	C0805X7R500-104KNE	0.1UF10% X7R 0805 50V Ceramic Chip Capacitor	Venkel
C127	0.1UF	C0805X7R500-104KNE	0.1UF10% X7R 0805 50V Ceramic Chip Capacitor	Venkel
C128	4.7UF	T491A475M016AS	4.7UF Tantalum Chip Capacitor 16V 3216	Kemet
C129	0.1UF	C0805X7R500-104KNE	0.1UF10% X7R 0805 50V Ceramic Chip Capacitor	Venkel
C130	0.1UF	C0805X7R500-104KNE	0.1UF10% X7R 0805 50V Ceramic Chip Capacitor	Venkel
C131	470PF	C080COG101-471JNE	470 PF 5% COG 0805 100V Ceramic Chip Capacitor	Venkel
C132	150PF	C080COG101-151JNE	150 PF 5% COG 0805 100V Ceramic Chip Capacitor	Venkel
C133	0.1UF	C0805X7R500-104KNE	0.1UF10% X7R 0805 50V Ceramic Chip Capacitor	Venkel
C134	150PF	C080COG101-151JNE	150 PF 5% COG 0805 100V Ceramic Chip Capacitor	Venkel
C135	470PF	C080COG101-471JNE	470 PF 5% COG 0805 100V Ceramic Chip Capacitor	Venkel
C136	470PF	C080COG101-471JNE	470 PF 5% COG 0805 100V Ceramic Chip Capacitor	Venkel
C137	150PF	C080COG101-151JNE	150 PF 5% COG 0805 100V Ceramic Chip Capacitor	Venkel
C138	0.1UF	C0805X7R500-104KNE	0.1UF10% X7R 0805 50V Ceramic Chip Capacitor	Venkel
C139	150PF	C080COG101-151JNE	150 PF 5% COG 0805 100V Ceramic Chip Capacitor	Venkel
C140	470PF	C080COG101-471JNE	470 PF 5% COG 0805 100V Ceramic Chip Capacitor	Venkel
C141	470PF	C080COG101-471JNE	470 PF 5% COG 0805 100V Ceramic Chip Capacitor	Venkel
C142	150PF	C080COG101-151JNE	150 PF 5% COG 0805 100V Ceramic Chip Capacitor	Venkel
C143	0.1UF	C0805X7R500-104KNE	0.1UF10% X7R 0805 50V Ceramic Chip Capacitor	Venkel
C144	150PF	C080COG101-151JNE	150 PF 5% COG 0805 100V Ceramic Chip Capacitor	Venkel
C145	470PF	C080COG101-471JNE	470 PF 5% COG 0805 100V Ceramic Chip Capacitor	Venkel
C146	470PF	C080COG101-471JNE	470 PF 5% COG 0805 100V Ceramic Chip Capacitor	Venkel
C147	150PF	C080COG101-151JNE	150 PF 5% COG 0805 100V Ceramic Chip Capacitor	Venkel
C148	0.1UF	C0805X7R500-104KNE	0.1UF10% X7R 0805 50V Ceramic Chip Capacitor	Venkel

Table B-1. EVM Bill of Materials

C149	150PF	C080COG101-151JNE	150 PF 5% COG 0805 100V Ceramic Chip Capacitor	Venkel
C150	470PF	C080COG101-471JNE	470 PF 5% COG 0805 100V Ceramic Chip Capacitor	Venkel
C151	470PF	C080COG101-471JNE	470 PF 5% COG 0805 100V Ceramic Chip Capacitor	Venkel
C152	150PF	C080COG101-151JNE	150 PF 5% COG 0805 100V Ceramic Chip Capacitor	Venkel
C153	0.1UF	C0805X7R500-104KNE	0.1UF10% X7R 0805 50V Ceramic Chip Capacitor	Venkel
C154	150PF	C080COG101-151JNE	150 PF 5% COG 0805 100V Ceramic Chip Capacitor	Venkel
C155	470PF	C080COG101-471JNE	470 PF 5% COG 0805 100V Ceramic Chip Capacitor	Venkel
C156	470PF	C080COG101-471JNE	470 PF 5% COG 0805 100V Ceramic Chip Capacitor	Venkel
C157	150PF	C080COG101-151JNE	150 PF 5% COG 0805 100V Ceramic Chip Capacitor	Venkel
C158	0.1UF	C0805X7R500-104KNE	0.1UF10% X7R 0805 50V Ceramic Chip Capacitor	Venkel
C159	150PF	C080COG101-151JNE	150 PF 5% COG 0805 100V Ceramic Chip Capacitor	Venkel
C160	470PF	C080COG101-471JNE	470 PF 5% COG 0805 100V Ceramic Chip Capacitor	Venkel
C161	470PF	C080COG101-471JNE	470 PF 5% COG 0805 100V Ceramic Chip Capacitor	Venkel
C162	0.1UF	C0805X7R500-104KNE	0.1UF10% X7R 0805 50V Ceramic Chip Capacitor	Venkel
C163	470PF	C080COG101-471JNE	470 PF 5% COG 0805 100V Ceramic Chip Capacitor	Venkel
C164	0.1UF	C0805X7R500-104KNE	0.1UF10% X7R 0805 50V Ceramic Chip Capacitor	Venkel
C165	470PF	C080COG101-471JNE	470 PF 5% COG 0805 100V Ceramic Chip Capacitor	Venkel
C166	470PF	C080COG101-471JNE	470 PF 5% COG 0805 100V Ceramic Chip Capacitor	Venkel
C167	0.1UF	C0805X7R500-104KNE	0.1UF10% X7R 0805 50V Ceramic Chip Capacitor	Venkel
C168	0.1UF	C0805X7R500-104KNE	0.1UF10% X7R 0805 50V Ceramic Chip Capacitor	Venkel
C169	0.1UF	C0805X7R500-104KNE	0.1UF10% X7R 0805 50V Ceramic Chip Capacitor	Venkel
C170	0.1UF	C0805X7R500-104KNE	0.1UF10% X7R 0805 50V Ceramic Chip Capacitor	Venkel
C171	0.1UF	C0805X7R500-104KNE	0.1UF10% X7R 0805 50V Ceramic Chip Capacitor	Venkel
C172	0.1UF	C0805X7R500-104KNE	0.1UF10% X7R 0805 50V Ceramic Chip Capacitor	Venkel
C173	4.7UF	T491A475M016AS	4.7UF Tantalum Chip Capacitor 16V 3216	Kemet
C174	4.7UF	T491A475M016AS	4.7UF Tantalum Chip Capacitor 16V 3216	Kemet
C175	0.1UF	C0805X7R500-104KNE	0.1UF10% X7R 0805 50V Ceramic Chip Capacitor	Venkel
C176	470PF	C080COG101-471JNE	470 PF 5% COG 0805 100V Ceramic Chip Capacitor	Venkel
C177	150PF	C080COG101-151JNE	150 PF 5% COG 0805 100V Ceramic Chip Capacitor	Venkel
C178	0.1UF	C0805X7R500-104KNE	0.1UF10% X7R 0805 50V Ceramic Chip Capacitor	Venkel
C179	470PF	C080COG101-471JNE	470 PF 5% COG 0805 100V Ceramic Chip Capacitor	Venkel
C180	150PF	C080COG101-151JNE	150 PF 5% COG 0805 100V Ceramic Chip Capacitor	Venkel
D1		SSL-LX15IC	Led Red Water Clear SOT-23	Lumex
D2		SSL-LX15IC	Led Red Water Clear SOT-23	Lumex
D3		SSL-LX15IC	Led Red Water Clear SOT-23	Lumex
D4		SSL-LX15IC	Led Red Water Clear SOT-23	Lumex
D5		SSL-LX15IC	Led Red Water Clear SOT-23	Lumex
D6		SSL-LX15IC	Led Red Water Clear SOT-23	Lumex
D7		SSL-LX15IC	Led Red Water Clear SOT-23	Lumex
D8		BAS16	High Conductance Ultra Fast Diode SOT23	Fairchild
D9		BAS16	High Conductance Ultra Fast Diode SOT23	Fairchild
D10		BAS16	High Conductance Ultra Fast Diode SOT23	Fairchild
D11		BAS16	High Conductance Ultra Fast Diode SOT23	Fairchild
J1		LN-0507B	5 Pin Right Angle DIN Connector	Vimex
J2		5075BR-04	Universal Serial Bus, 4 position, female connector-black	Vimex
J3		205A-09FGTBBC3	9 Pin Female Right Angle D-Sub Connector .318"	Vimex
J4		205A-25MGTBBC3	25 Pin Male Right Angle D-Sub Connector .318"	Vimex
J5		73-096114-300	96-pin 3-row DIN41612 Female Type C Straight Connector .110" Tail Length	Teka
J6		JE040060BN	2 X 2 RCA Jack All Black Nickel Plated	Vimex

Table B-1. EVM Bill of Materials

J7		73-096114-300	96-pin 3-row DIN41612 Female Type C Straight Connector .110" Tail Length	Teka
J8		JE040060TN	2 X 2 RCA Jack Top-White/Yellow Bottom Red/Yellow - Nickel	Vimex
J9		SCJ-0367	3.5 MM Stereo Phone Jack	Vimex
J10		SCJ-0367	3.5 MM Stereo Phone Jack	Vimex
J11		JE0600610N	3 X 2 RCA Jack Top White Bottom Red-Nickel	Vimex
J12		JE0600610N	3 X 2 RCA Jack Top White Bottom Red-Nickel	Vimex
J13		SCJ-0367	3.5 MM Stereo Phone Jack	Vimex
JP1-2		AFM2-26SG6MM/3.55MM	13 X 2 Header 2.54mm on center 6 mm/3.0mm	Vimex
JP3-4		AFM2-20SG6MM/3.55MM	10 X 2 Header 2.54mm on center 6 mm/3.0mm	Vimex
JP5		AFM2-64SG6MM/3.55MM	32 X 2 Header 2.54mm on center 6 mm/3.0mm	Vimex
JP6-11		AFM2-40SG6MM/3.55MM	20 X 2 Header 2.54mm on center 6 mm/3.0mm	Vimex
P1		AFM2-10SG6MM/3.55MM	5 X 2 Header 2.54mm on center 6 mm/3.0mm	Vimex
P2		AFM2-14SG6MM/3.55MM	7 X 2 Header 2.54mm on center 6 mm/3.0mm	Vimex
P3		AFM2-28SG6MM/3.55MM	14 X 2 Header 2.54mm on center 6 mm/3.0mm	Vimex
Q1	NONE		Do Not Install	
Q2	NONE		Do Not Install	
Q3	NONE		Do Not Install	
Q4	NONE		Do Not Install	
Q5		FMMTA56	PNP Transistor SOT23	
Q6		MMBF170	Power MOSFET 500 mAmps, 60V SOT-23	ON Semiconductor
Q7		MMBF170	Power MOSFET 500 mAmps, 60V SOT-23	ON Semiconductor
Q8		FMMTA56	PNP Transistor SOT23	Zetex
Q9		MMBF170	Power MOSFET 500 mAmps, 60V SOT-23	ON Semiconductor
Q10		MMBF170	Power MOSFET 500 mAmps, 60V SOT-23	ON Semiconductor
Q11		FMMTA56	PNP Transistor SOT23	Zetex
Q12		FMMTA56	PNP Transistor SOT23	Zetex
Q13		FMMTA06	NPN Transistor SOT23	Zetex
Q14		FMMTA06	NPN Transistor SOT23	Zetex
Q15		FZT796ATA	PNP Transistor SOT223	Zetex
Q16		FZT696BTA	NPN Transistor SOT223	Zetex
Q17		FMMTA06	NPN Transistor SOT23	Zetex
Q18		FMMTA06	NPN Transistor SOT23	Zetex
Q19		FMMTA06	NPN Transistor SOT23	Zetex
Q20		FMMTA06	NPN Transistor SOT23	Zetex
Q21		FMMTA06	NPN Transistor SOT23	Zetex
Q22		FMMTA06	NPN Transistor SOT23	Zetex
Q23		FMMTA06	NPN Transistor SOT23	Zetex
Q24		FMMTA06	NPN Transistor SOT23	Zetex
Q25		FMMTA06	NPN Transistor SOT23	Zetex
Q26		FMMTA06	NPN Transistor SOT23	Zetex
Q27		FMMTA06	NPN Transistor SOT23	Zetex
Q28		FMMTA06	NPN Transistor SOT23	Zetex
Q29		FMMTA06	NPN Transistor SOT23	Zetex
Q30		FMMTA06	NPN Transistor SOT23	Zetex
Q31		FMMTA06	NPN Transistor SOT23	Zetex
Q32		FMMTA06	NPN Transistor SOT23	Zetex
Q33		FMMTA06	NPN Transistor SOT23	Zetex
Q34		FMMTA06	NPN Transistor SOT23	Zetex
Q35		FMMTA06	NPN Transistor SOT23	Zetex
Q36		FMMTA06	NPN Transistor SOT23	Zetex

Table B-1. EVM Bill of Materials

Q37		FMMTA06	NPN Transistor SOT23	Zetex
Q38		FMMTA06	NPN Transistor SOT23	Zetex
Q39		FMMTA06	NPN Transistor SOT23	Zetex
Q40		FMMTA06	NPN Transistor SOT23	Zetex
Q41		FMMTA06	NPN Transistor SOT23	Zetex
R1		CR0805-10W-24R9FT	24.9 1% 0805 .1 W Thick Film Chip Resistor	Venkel
R2		CR0805-10W-24R9FT	24.9 1% 0805 .1 W Thick Film Chip Resistor	Venkel
R3	0.0	CR0805-10W-000T	ZERO OHM Jumper 0805	B
R4	0.0	CR0805-10W-000T	ZERO OHM Jumper 0805	Venkel
R5	20K	CR0805-10W-2002FT	20K 1% 0805 .1 W Thick Film Chip Resistor	Venkel
R6	10K	CR0805-10W-1002FT	10K 1% 0805 .1 W Thick Film Chip Resistor	Venkel
R7	20K	CR0805-10W-2002FT	20K 1% 0805 .1 W Thick Film Chip Resistor	Venkel
R8	10K	CR0805-10W-1002FT	10K 1% 0805 .1 W Thick Film Chip Resistor	Venkel
R9	4.99K	RR1220P-4991-D-M	4.99K 0.5% 0805 .1 W Thin Film Chip Resistor	Susumu Co Ltd
R10	10K	CR0805-10W-1002FT	10K 1% 0805 .1 W Thick Film Chip Resistor	Venkel
R11	10K	CR0805-10W-1002FT	10K 1% 0805 .1 W Thick Film Chip Resistor	Venkel
R12	4.99K	RR1220P-4991-D-M	4.99K 0.5% 0805 .1 W Thin Film Chip Resistor	Susumu Co Ltd
R13	4.99K	RR1220P-4991-D-M	4.99K 0.5% 0805 .1 W Thin Film Chip Resistor	Susumu Co Ltd
R14	10K	CR0805-10W-1002FT	10K 1% 0805 .1 W Thick Film Chip Resistor	Venkel
R15	10K	CR0805-10W-1002FT	10K 1% 0805 .1 W Thick Film Chip Resistor	Venkel
R16	4.99K	RR1220P-4991-D-M	4.99K 0.5% 0805 .1 W Thin Film Chip Resistor	Susumu Co Ltd
R17	4.99K	RR1220P-4991-D-M	4.99K 0.5% 0805 .1 W Thin Film Chip Resistor	Susumu Co Ltd
R18	10K	CR0805-10W-1002FT	10K 1% 0805 .1 W Thick Film Chip Resistor	Venkel
R19	10K	CR0805-10W-1002FT	10K 1% 0805 .1 W Thick Film Chip Resistor	Venkel
R20	4.99K	RR1220P-4991-D-M	4.99K 0.5% 0805 .1 W Thin Film Chip Resistor	Susumu Co Ltd
R21	4.99K	RR1220P-4991-D-M	4.99K 0.5% 0805 .1 W Thin Film Chip Resistor	Susumu Co Ltd
R22	10K	CR0805-10W-1002FT	10K 1% 0805 .1 W Thick Film Chip Resistor	Venkel
R23	10K	CR0805-10W-1002FT	10K 1% 0805 .1 W Thick Film Chip Resistor	Venkel
R24	4.99K	RR1220P-4991-D-M	4.99K 0.5% 0805 .1 W Thin Film Chip Resistor	Susumu Co Ltd
R25	4.99K	RR1220P-4991-D-M	4.99K 0.5% 0805 .1 W Thin Film Chip Resistor	Susumu Co Ltd
R26	10K	CR0805-10W-1002FT	10K 1% 0805 .1 W Thick Film Chip Resistor	Venkel
R27	10K	CR0805-10W-1002FT	10K 1% 0805 .1 W Thick Film Chip Resistor	Venkel
R28	4.99K	RR1220P-4991-D-M	4.99K 0.5% 0805 .1 W Thin Film Chip Resistor	Susumu Co Ltd
R29	4.99K	RR1220P-4991-D-M	4.99K 0.5% 0805 .1 W Thin Film Chip Resistor	Susumu Co Ltd
R30	10K	CR0805-10W-1002FT	10K 1% 0805 .1 W Thick Film Chip Resistor	Venkel
R31	10K	CR0805-10W-1002FT	10K 1% 0805 .1 W Thick Film Chip Resistor	Venkel
R32	4.99K	RR1220P-4991-D-M	4.99K 0.5% 0805 .1 W Thin Film Chip Resistor	Susumu Co Ltd
R33	20K	CR0805-10W-2002FT	20K 1% 0805 .1 W Thick Film Chip Resistor	Venkel
R34	20K	CR0805-10W-2002FT	20K 1% 0805 .1 W Thick Film Chip Resistor	Venkel
R35	20K	CR0805-10W-2002FT	20K 1% 0805 .1 W Thick Film Chip Resistor	Venkel
R36		CR0805-10W-2000FT	200 1% 0805 .1 W Thick Film Chip Resistor	Venkel
R37		CR0805-10W-2000FT	200 1% 0805 .1 W Thick Film Chip Resistor	Venkel
R38		CR0805-10W-2000FT	200 1% 0805 .1 W Thick Film Chip Resistor	Venkel
R39		CR0805-10W-2000FT	200 1% 0805 .1 W Thick Film Chip Resistor	Venkel
R40		CR0805-10W-2000FT	200 1% 0805 .1 W Thick Film Chip Resistor	Venkel
R41		CR0805-10W-2000FT	200 1% 0805 .1 W Thick Film Chip Resistor	Venkel
R42		CR0805-10W-2000FT	200 1% 0805 .1 W Thick Film Chip Resistor	Venkel
R43		CR0805-10W-2000FT	200 1% 0805 .1 W Thick Film Chip Resistor	Venkel
R44		CR0805-10W-2000FT	200 1% 0805 .1 W Thick Film Chip Resistor	Venkel
R45		CR0805-10W-2000FT	200 1% 0805 .1 W Thick Film Chip Resistor	Venkel
R46		CR0805-10W-2000FT	200 1% 0805 .1 W Thick Film Chip Resistor	Venkel

DSPAUDIOEVM Users Guide, Rev. 2.4

Table B-1. EVM Bill of Materials

R47		CR0805-10W-2000FT	200 1% 0805 .1 W Thick Film Chip Resistor	Venkel
R48		CR0805-10W-2000FT	200 1% 0805 .1 W Thick Film Chip Resistor	Venkel
R49		CR0805-10W-2000FT	200 1% 0805 .1 W Thick Film Chip Resistor	Venkel
R50		CR0805-10W-2000FT	200 1% 0805 .1 W Thick Film Chip Resistor	Venkel
R51		CR0805-10W-2000FT	200 1% 0805 .1 W Thick Film Chip Resistor	Venkel
R52		CR0805-10W-2000FT	200 1% 0805 .1 W Thick Film Chip Resistor	Venkel
R53		CR0805-10W-2000FT	200 1% 0805 .1 W Thick Film Chip Resistor	Venkel
R54		CR0805-10W-2000FT	200 1% 0805 .1 W Thick Film Chip Resistor	Venkel
R55		CR0805-10W-2000FT	200 1% 0805 .1 W Thick Film Chip Resistor	Venkel
R56		CR0805-10W-2000FT	200 1% 0805 .1 W Thick Film Chip Resistor	Venkel
R57		CR0805-10W-2000FT	200 1% 0805 .1 W Thick Film Chip Resistor	Venkel
R58		CR0805-10W-2000FT	200 1% 0805 .1 W Thick Film Chip Resistor	Venkel
R59		CR0805-10W-2000FT	200 1% 0805 .1 W Thick Film Chip Resistor	Venkel
R60		CR0805-10W-2000FT	200 1% 0805 .1 W Thick Film Chip Resistor	Venkel
R61		CR0805-10W-2000FT	200 1% 0805 .1 W Thick Film Chip Resistor	Venkel
R62		CR0805-10W-2000FT	200 1% 0805 .1 W Thick Film Chip Resistor	Venkel
R63		CR0805-10W-2000FT	200 1% 0805 .1 W Thick Film Chip Resistor	Venkel
R64		CR0805-10W-2000FT	200 1% 0805 .1 W Thick Film Chip Resistor	Venkel
R65		CR0805-10W-2000FT	200 1% 0805 .1 W Thick Film Chip Resistor	Venkel
R66		CR0805-10W-2000FT	200 1% 0805 .1 W Thick Film Chip Resistor	Venkel
R67		CR0805-10W-2000FT	200 1% 0805 .1 W Thick Film Chip Resistor	Venkel
R68		CR0805-10W-2000FT	200 1% 0805 .1 W Thick Film Chip Resistor	Venkel
R69		CR0805-10W-2000FT	200 1% 0805 .1 W Thick Film Chip Resistor	Venkel
R70		CR0805-10W-2000FT	200 1% 0805 .1 W Thick Film Chip Resistor	Venkel
R71		CR0805-10W-2000FT	200 1% 0805 .1 W Thick Film Chip Resistor	Venkel
R72	NONE		Do Not Install	
R73	0.0	CR0805-10W-000T	ZERO OHM Jumper 0805	Venkel
R74	NONE		Do Not Install	
R75	NONE		Do Not Install	
R76	0.0	CR0805-10W-000T	ZERO OHM Jumper 0805	Venkel
R77	NONE		Do Not Install	
R78	0.0	CR0805-10W-000T	ZERO OHM Jumper 0805	Venkel
R79		CR0805-10W-3320FT	332 1% 0805 .1 W Thick Film Chip Resistor	Venkel
R80	1.1K	CR0805-10W-1101FT	1.1K 1% 0805 .1 W Thick Film Chip Resistor	Venkel
R81	NONE		Do Not Install	
R82	1.1K	CR0805-10W-1101FT	1.1K 1% 0805 .1 W Thick Film Chip Resistor	Venkel
R83		CR0805-10W-1540FT	154 1% 0805 .1 W Thick Film Chip Resistor	Venkel
R84	NONE		Do Not Install	
R85	10K	CR0805-10W-1002FT	10K 1% 0805 .1 W Thick Film Chip Resistor	Venkel
R86	0.0	CR0805-10W-000T	ZERO OHM Jumper 0805	Venkel
R87	10K	CR0805-10W-1002FT	10K 1% 0805 .1 W Thick Film Chip Resistor	Venkel
R88	10K	CR0805-10W-1002FT	10K 1% 0805 .1 W Thick Film Chip Resistor	Venkel
R89	10K	CR0805-10W-1002FT	10K 1% 0805 .1 W Thick Film Chip Resistor	Venkel
R90	10K	CR0805-10W-1002FT	10K 1% 0805 .1 W Thick Film Chip Resistor	Venkel
R91	10K	CR0805-10W-1002FT	10K 1% 0805 .1 W Thick Film Chip Resistor	Venkel
R92	10K	CR0805-10W-1002FT	10K 1% 0805 .1 W Thick Film Chip Resistor	Venkel
R93		CR0805-10W-24R9FT	24.9 1% 0805 .1 W Thick Film Chip Resistor	Venkel
R94		CR0805-10W-24R9FT	24.9 1% 0805 .1 W Thick Film Chip Resistor	Venkel
R95	10K	CR0805-10W-1002FT	10K 1% 0805 .1 W Thick Film Chip Resistor	Venkel
R96	100K	CR0805-10W-1003FT	100K 1% 0805 .1 W Thick Film Chip Resistor	Venkel
R97	10K	CR0805-10W-1002FT	10K 1% 0805 .1 W Thick Film Chip Resistor	Venkel

Table B-1. EVM Bill of Materials

R98	10K	CR0805-10W-1002FT	10K 1% 0805 .1 W Thick Film Chip Resistor	Venkel
R99	10K	CR0805-10W-1002FT	10K 1% 0805 .1 W Thick Film Chip Resistor	Venkel
R100	10K	CR0805-10W-1002FT	10K 1% 0805 .1 W Thick Film Chip Resistor	Venkel
R101	10K	CR0805-10W-1002FT	10K 1% 0805 .1 W Thick Film Chip Resistor	Venkel
R102	10K	CR0805-10W-1002FT	10K 1% 0805 .1 W Thick Film Chip Resistor	Venkel
R103	10K	CR0805-10W-1002FT	10K 1% 0805 .1 W Thick Film Chip Resistor	Venkel
R104	10K	CR0805-10W-1002FT	10K 1% 0805 .1 W Thick Film Chip Resistor	Venkel
R105		CR0805-10W-4020FT	402 1% 0805 .1 W Thick Film Chip Resistor	Venkel
R106	10K	CR0805-10W-1002FT	10K 1% 0805 .1 W Thick Film Chip Resistor	Venkel
R107	10K	CR0805-10W-1002FT	10K 1% 0805 .1 W Thick Film Chip Resistor	Venkel
R108		CR0805-10W-2430FT	243 1% 0805 .1 W Thick Film Chip Resistor	Venkel
R109	10K	CR0805-10W-1002FT	10K 1% 0805 .1 W Thick Film Chip Resistor	Venkel
R110	10K	CR0805-10W-1002FT	10K 1% 0805 .1 W Thick Film Chip Resistor	Venkel
R111	10K	CR0805-10W-1002FT	10K 1% 0805 .1 W Thick Film Chip Resistor	Venkel
R112	10K	CR0805-10W-1002FT	10K 1% 0805 .1 W Thick Film Chip Resistor	Venkel
R113	10K	CR0805-10W-1002FT	10K 1% 0805 .1 W Thick Film Chip Resistor	Venkel
R114	10K	CR0805-10W-1002FT	10K 1% 0805 .1 W Thick Film Chip Resistor	Venkel
R115	10K	CR0805-10W-1002FT	10K 1% 0805 .1 W Thick Film Chip Resistor	Venkel
R116	10K	CR0805-10W-1002FT	10K 1% 0805 .1 W Thick Film Chip Resistor	Venkel
R117	10K	CR0805-10W-1002FT	10K 1% 0805 .1 W Thick Film Chip Resistor	Venkel
R118	10K	CR0805-10W-1002FT	10K 1% 0805 .1 W Thick Film Chip Resistor	Venkel
R119	10K	CR0805-10W-1002FT	10K 1% 0805 .1 W Thick Film Chip Resistor	Venkel
R120		CR0805-10W-1100FT	110 1% 0805 .1 W Thick Film Chip Resistor	Venkel
R121	10K	CR0805-10W-1002FT	10K 1% 0805 .1 W Thick Film Chip Resistor	Venkel
R122		CR0805-10W-2430FT	243 1% 0805 .1 W Thick Film Chip Resistor	Venkel
R123	10K	CR0805-10W-1002FT	10K 1% 0805 .1 W Thick Film Chip Resistor	Venkel
R124		CR0805-10W-1100FT	110 1% 0805 .1 W Thick Film Chip Resistor	Venkel
R125		CR0805-10W-3320FT	332 1% 0805 .1 W Thick Film Chip Resistor	Venkel
R126		CR0805-10W-1100FT	110 1% 0805 .1 W Thick Film Chip Resistor	Venkel
R127		CR0805-10W-3320FT	332 1% 0805 .1 W Thick Film Chip Resistor	Venkel
R128	1K	CR0805-10W-1001FT	1K 1% 0805 .1 W Thick Film Chip Resistor	Venkel
R129		CR0805-10W-1100FT	110 1% 0805 .1 W Thick Film Chip Resistor	Venkel
R130		CR0805-10W-1100FT	110 1% 0805 .1 W Thick Film Chip Resistor	Venkel
R131		CR0805-10W-3320FT	332 1% 0805 .1 W Thick Film Chip Resistor	Venkel
R132		CR0805-10W-3320FT	332 1% 0805 .1 W Thick Film Chip Resistor	Venkel
R133	10K	CR0805-10W-1002FT	10K 1% 0805 .1 W Thick Film Chip Resistor	Venkel
R134	100K	CR0805-10W-1003FT	100K 1% 0805 .1 W Thick Film Chip Resistor	Venkel
R135	1K	CR0805-10W-1001FT	1K 1% 0805 .1 W Thick Film Chip Resistor	Venkel
R136	10K	CR0805-10W-1002FT	10K 1% 0805 .1 W Thick Film Chip Resistor	Venkel
R137	10K	CR0805-10W-1002FT	10K 1% 0805 .1 W Thick Film Chip Resistor	Venkel
R138	1K	CR0805-10W-1001FT	1K 1% 0805 .1 W Thick Film Chip Resistor	Venkel
R139	1K	CR0805-10W-1001FT	1K 1% 0805 .1 W Thick Film Chip Resistor	Venkel
R140	10K	CR0805-10W-1002FT	10K 1% 0805 .1 W Thick Film Chip Resistor	Venkel
R141	10K	CR0805-10W-1002FT	10K 1% 0805 .1 W Thick Film Chip Resistor	Venkel
R142	100K	CR0805-10W-1003FT	100K 1% 0805 .1 W Thick Film Chip Resistor	Venkel
R143	7.5K	CR080510W-7501FT	7.5K 1% 0805 .1 W Thick Film Chip Resistor	Venkel
R144	2.49K	CR0805-10W-2491FT	2.49K 1% 0805 .1 W Thick Film Chip Resistor	Venkel
R145	1.5K	CR0805-10W-1501FT	1.5K 1% 0805 .1 W Thick Film Chip Resistor	Venkel
R146	10K	CR0805-10W-1002FT	10K 1% 0805 .1 W Thick Film Chip Resistor	Venkel
R147	100K	CR0805-10W-1003FT	100K 1% 0805 .1 W Thick Film Chip Resistor	Venkel
R148	10K	CR0805-10W-1002FT	10K 1% 0805 .1 W Thick Film Chip Resistor	Venkel

DSPAUDIOEVM Users Guide, Rev. 2.4

Table B-1. EVM Bill of Materials

R149	100K	CR0805-10W-1003FT	100K 1% 0805 .1 W Thick Film Chip Resistor	Venkel
R150	10K	CR0805-10W-1002FT	10K 1% 0805 .1 W Thick Film Chip Resistor	Venkel
R151	10K	CR0805-10W-1002FT	10K 1% 0805 .1 W Thick Film Chip Resistor	Venkel
R152	10K	CR0805-10W-1002FT	10K 1% 0805 .1 W Thick Film Chip Resistor	Venkel
R153	10K	CR0805-10W-1002FT	10K 1% 0805 .1 W Thick Film Chip Resistor	Venkel
R154	1K	CR0805-10W-1001FT	1K 1% 0805 .1 W Thick Film Chip Resistor	Venkel
R155	1K	CR0805-10W-1001FT	1K 1% 0805 .1 W Thick Film Chip Resistor	Venkel
R156	NONE		Do Not Install	
R157	10M	CR0805-10W-1005FT	10M 1% 0805 .1 W Thick Film Chip Resistor	Venkel
R158	1K	CR0805-10W-1001FT	1K 1% 0805 .1 W Thick Film Chip Resistor	Venkel
R159	10M	CR0805-10W-1005FT	10M 1% 0805 .1 W Thick Film Chip Resistor	Venkel
R160	10K	CR0805-10W-1002FT	10K 1% 0805 .1 W Thick Film Chip Resistor	Venkel
R161	10K	CR0805-10W-1002FT	10K 1% 0805 .1 W Thick Film Chip Resistor	Venkel
R162	10K	CR0805-10W-1002FT	10K 1% 0805 .1 W Thick Film Chip Resistor	Venkel
R163	7.5K	CR080510W-7501FT	7.5K 1% 0805 .1 W Thick Film Chip Resistor	Venkel
R164	2.49K	CR0805-10W-2491FT	2.49K 1% 0805 .1 W Thick Film Chip Resistor	Venkel
R165	10K	CR0805-10W-1002FT	10K 1% 0805 .1 W Thick Film Chip Resistor	Venkel
R166	NONE		Do Not Install	
R167	0.0	CR0805-10W-000T	ZERO OHM Jumper 0805	Venkel
R168	100K	CR0805-10W-1003FT	100K 1% 0805 .1 W Thick Film Chip Resistor	Venkel
R169	100K	CR0805-10W-1003FT	100K 1% 0805 .1 W Thick Film Chip Resistor	Venkel
R170	10K	CR0805-10W-1002FT	10K 1% 0805 .1 W Thick Film Chip Resistor	Venkel
R171	10K	CR0805-10W-1002FT	10K 1% 0805 .1 W Thick Film Chip Resistor	Venkel
R172	1K	CR0805-10W-1001FT	1K 1% 0805 .1 W Thick Film Chip Resistor	Venkel
R173	1K	CR0805-10W-1001FT	1K 1% 0805 .1 W Thick Film Chip Resistor	Venkel
R174	10K	CR0805-10W-1002FT	10K 1% 0805 .1 W Thick Film Chip Resistor	Venkel
R175	10K	CR0805-10W-1002FT	10K 1% 0805 .1 W Thick Film Chip Resistor	Venkel
R176	10K	CR0805-10W-1002FT	10K 1% 0805 .1 W Thick Film Chip Resistor	Venkel
R177		CR0805-10W-1100FT	110 1% 0805 .1 W Thick Film Chip Resistor	Venkel
R178	NONE		Do Not Install	
R179	0.0	CR0805-10W-000T	ZERO OHM Jumper 0805	Venkel
R180	0.0	CR0805-10W-000T	ZERO OHM Jumper 0805	Venkel
R181	18K	CR0805-10W-183JT	18K 5% 0805 .1 W Thick Film Chip Resistor	Venkel
R182	100K	CR0805-10W-1003FT	100K 1% 0805 .1 W Thick Film Chip Resistor	Venkel
R183	10K	CR0805-10W-1002FT	10K 1% 0805 .1 W Thick Film Chip Resistor	Venkel
R184	100K	CR0805-10W-1003FT	100K 1% 0805 .1 W Thick Film Chip Resistor	Venkel
R185	0.0	CR0805-10W-000T	ZERO OHM Jumper 0805	Venkel
R186	10K	CR0805-10W-1002FT	10K 1% 0805 .1 W Thick Film Chip Resistor	Venkel
R187	10K	CR0805-10W-1002FT	10K 1% 0805 .1 W Thick Film Chip Resistor	Venkel
R188	10K	CR0805-10W-1002FT	10K 1% 0805 .1 W Thick Film Chip Resistor	Venkel
R189	76.8K	CR0805-10W-7682FT	76.8K 1% 0805 .1 W Thick Film Chip Resistor	Venkel
R190	NONE		Do Not Install	
R191	1.74K	CR0805-10W-1741FT	1.74K 1% 0805 .1 W Thick Film Chip Resistor	Venkel
R192		CR0805-10W-1100FT	110 1% 0805 .1 W Thick Film Chip Resistor	Venkel
R193	0.0	CR0805-10W-000T	ZERO OHM Jumper 0805	Venkel
R194		CR0805-10W-1540FT	154 1% 0805 .1 W Thick Film Chip Resistor	Venkel
R195	10K	CR0805-10W-1002FT	10K 1% 0805 .1 W Thick Film Chip Resistor	Venkel
R196	10K	CR0805-10W-1002FT	10K 1% 0805 .1 W Thick Film Chip Resistor	Venkel
R197	10K	CR0805-10W-1002FT	10K 1% 0805 .1 W Thick Film Chip Resistor	Venkel
R198		CR0805-10W-24R9FT	24.9 1% 0805 .1 W Thick Film Chip Resistor	Venkel
R199	10K	CR0805-10W-1002FT	10K 1% 0805 .1 W Thick Film Chip Resistor	Venkel

Table B-1. EVM Bill of Materials

R200	10K	CR0805-10W-1002FT	10K 1% 0805 .1 W Thick Film Chip Resistor	Venkel
R201	10K	CR0805-10W-1002FT	10K 1% 0805 .1 W Thick Film Chip Resistor	Venkel
R202	10K	CR0805-10W-1002FT	10K 1% 0805 .1 W Thick Film Chip Resistor	Venkel
R203	100K	CR0805-10W-1003FT	100K 1% 0805 .1 W Thick Film Chip Resistor	Venkel
R204	100K	CR0805-10W-1003FT	100K 1% 0805 .1 W Thick Film Chip Resistor	Venkel
R205		CR0805-10W-1100FT	110 1% 0805 .1 W Thick Film Chip Resistor	Venkel
R206	1K	CR0805-10W-1001FT	1K 1% 0805 .1 W Thick Film Chip Resistor	Venkel
R207	1K	CR0805-10W-1001FT	1K 1% 0805 .1 W Thick Film Chip Resistor	Venkel
R208		CR0805-10W-7320FT	732 1% 0805 .1 W Thick Film Chip Resistor	Venkel
R209		CR0805-10W-2430FT	243 1% 0805 .1 W Thick Film Chip Resistor	Venkel
R210	10K	CR0805-10W-1002FT	10K 1% 0805 .1 W Thick Film Chip Resistor	Venkel
R211	10K	CR0805-10W-1002FT	10K 1% 0805 .1 W Thick Film Chip Resistor	Venkel
R212		CR0805-10W-1100FT	110 1% 0805 .1 W Thick Film Chip Resistor	Venkel
R213	NONE		Do Not Install	
R214	10K	CR0805-10W-1002FT	10K 1% 0805 .1 W Thick Film Chip Resistor	Venkel
R215	10K	CR0805-10W-1002FT	10K 1% 0805 .1 W Thick Film Chip Resistor	Venkel
R216	10K	CR0805-10W-1002FT	10K 1% 0805 .1 W Thick Film Chip Resistor	Venkel
R217	10K	CR0805-10W-1002FT	10K 1% 0805 .1 W Thick Film Chip Resistor	Venkel
R218	10K	CR0805-10W-1002FT	10K 1% 0805 .1 W Thick Film Chip Resistor	Venkel
R219	10K	CR0805-10W-1002FT	10K 1% 0805 .1 W Thick Film Chip Resistor	Venkel
R220	10K	CR0805-10W-1002FT	10K 1% 0805 .1 W Thick Film Chip Resistor	Venkel
R221	10K	CR0805-10W-1002FT	10K 1% 0805 .1 W Thick Film Chip Resistor	Venkel
R222	10K	CR0805-10W-1002FT	10K 1% 0805 .1 W Thick Film Chip Resistor	Venkel
R223	10K	CR0805-10W-1002FT	10K 1% 0805 .1 W Thick Film Chip Resistor	Venkel
R224	10K	CR0805-10W-1002FT	10K 1% 0805 .1 W Thick Film Chip Resistor	Venkel
R225	10K	CR0805-10W-1002FT	10K 1% 0805 .1 W Thick Film Chip Resistor	Venkel
R226	10K	CR0805-10W-1002FT	10K 1% 0805 .1 W Thick Film Chip Resistor	Venkel
R227	10K	CR0805-10W-1002FT	10K 1% 0805 .1 W Thick Film Chip Resistor	Venkel
R228	10K	CR0805-10W-1002FT	10K 1% 0805 .1 W Thick Film Chip Resistor	Venkel
R229	10K	CR0805-10W-1002FT	10K 1% 0805 .1 W Thick Film Chip Resistor	Venkel
R230	10K	CR0805-10W-1002FT	10K 1% 0805 .1 W Thick Film Chip Resistor	Venkel
R231	10K	CR0805-10W-1002FT	10K 1% 0805 .1 W Thick Film Chip Resistor	Venkel
R232	20K	CR0805-10W-2002FT	20K 1% 0805 .1 W Thick Film Chip Resistor	Venkel
R233	NONE		Do Not Install	
R234	10K	CR0805-10W-1002FT	10K 1% 0805 .1 W Thick Film Chip Resistor	Venkel
R235	10K	CR0805-10W-1002FT	10K 1% 0805 .1 W Thick Film Chip Resistor	Venkel
R236	10K	CR0805-10W-1002FT	10K 1% 0805 .1 W Thick Film Chip Resistor	Venkel
R237	10K	CR0805-10W-1002FT	10K 1% 0805 .1 W Thick Film Chip Resistor	Venkel
R238	10K	CR0805-10W-1002FT	10K 1% 0805 .1 W Thick Film Chip Resistor	Venkel
R239	10K	CR0805-10W-1002FT	10K 1% 0805 .1 W Thick Film Chip Resistor	Venkel
R240	10K	CR0805-10W-1002FT	10K 1% 0805 .1 W Thick Film Chip Resistor	Venkel
R241	10K	CR0805-10W-1002FT	10K 1% 0805 .1 W Thick Film Chip Resistor	Venkel
R242	10K	CR0805-10W-1002FT	10K 1% 0805 .1 W Thick Film Chip Resistor	Venkel
R243	10K	CR0805-10W-1002FT	10K 1% 0805 .1 W Thick Film Chip Resistor	Venkel
R244	20K	CR0805-10W-2002FT	20K 1% 0805 .1 W Thick Film Chip Resistor	Venkel
R245		CR0805-10W-2430FT	243 1% 0805 .1 W Thick Film Chip Resistor	Venkel
R246	NONE		Do Not Install	
R247	10K	CR0805-10W-1002FT	10K 1% 0805 .1 W Thick Film Chip Resistor	Venkel
R248	10K	CR0805-10W-1002FT	10K 1% 0805 .1 W Thick Film Chip Resistor	Venkel
R249	4.99K	RR1220P-4991-D-M	4.99K 0.5% 0805 .1 W Thin Film Chip Resistor	Susumu Co Ltd
R250	4.99K	RR1220P-4991-D-M	4.99K 0.5% 0805 .1 W Thin Film Chip Resistor	Susumu Co Ltd

DSPAUDIOEVM Users Guide, Rev. 2.4

Table B-1. EVM Bill of Materials

R251	10K	CR0805-10W-1002FT	10K 1% 0805 .1 W Thick Film Chip Resistor	Venkel
R252	4.99K	RR1220P-4991-D-M	4.99K 0.5% 0805 .1 W Thin Film Chip Resistor	Susumu Co Ltd
R253	4.99K	RR1220P-4991-D-M	4.99K 0.5% 0805 .1 W Thin Film Chip Resistor	Susumu Co Ltd
R254	10K	CR0805-10W-1002FT	10K 1% 0805 .1 W Thick Film Chip Resistor	Venkel
R255	4.99K	RR1220P-4991-D-M	4.99K 0.5% 0805 .1 W Thin Film Chip Resistor	Susumu Co Ltd
R256	4.99K	RR1220P-4991-D-M	4.99K 0.5% 0805 .1 W Thin Film Chip Resistor	Susumu Co Ltd
R257	4.99K	RR1220P-4991-D-M	4.99K 0.5% 0805 .1 W Thin Film Chip Resistor	Susumu Co Ltd
R258	10K	CR0805-10W-1002FT	10K 1% 0805 .1 W Thick Film Chip Resistor	Venkel
R259	4.99K	RR1220P-4991-D-M	4.99K 0.5% 0805 .1 W Thin Film Chip Resistor	Susumu Co Ltd
R260	10K	CR0805-10W-1002FT	10K 1% 0805 .1 W Thick Film Chip Resistor	Venkel
R261	4.99K	RR1220P-4991-D-M	4.99K 0.5% 0805 .1 W Thin Film Chip Resistor	Susumu Co Ltd
R262	4.99K	RR1220P-4991-D-M	4.99K 0.5% 0805 .1 W Thin Film Chip Resistor	Susumu Co Ltd
R263	4.99K	RR1220P-4991-D-M	4.99K 0.5% 0805 .1 W Thin Film Chip Resistor	Susumu Co Ltd
R264	4.99K	RR1220P-4991-D-M	4.99K 0.5% 0805 .1 W Thin Film Chip Resistor	Susumu Co Ltd
R265	10K	CR0805-10W-1002FT	10K 1% 0805 .1 W Thick Film Chip Resistor	Venkel
R266	4.99K	RR1220P-4991-D-M	4.99K 0.5% 0805 .1 W Thin Film Chip Resistor	Susumu Co Ltd
R267	4.99K	RR1220P-4991-D-M	4.99K 0.5% 0805 .1 W Thin Film Chip Resistor	Susumu Co Ltd
R268	10K	CR0805-10W-1002FT	10K 1% 0805 .1 W Thick Film Chip Resistor	Venkel
R269	10K	CR0805-10W-1002FT	10K 1% 0805 .1 W Thick Film Chip Resistor	Venkel
R270	4.99K	RR1220P-4991-D-M	4.99K 0.5% 0805 .1 W Thin Film Chip Resistor	Susumu Co Ltd
R271	4.99K	RR1220P-4991-D-M	4.99K 0.5% 0805 .1 W Thin Film Chip Resistor	Susumu Co Ltd
R272	10K	CR0805-10W-1002FT	10K 1% 0805 .1 W Thick Film Chip Resistor	Venkel
R273	4.99K	RR1220P-4991-D-M	4.99K 0.5% 0805 .1 W Thin Film Chip Resistor	Susumu Co Ltd
R274	4.99K	RR1220P-4991-D-M	4.99K 0.5% 0805 .1 W Thin Film Chip Resistor	Susumu Co Ltd
R275	4.99K	RR1220P-4991-D-M	4.99K 0.5% 0805 .1 W Thin Film Chip Resistor	Susumu Co Ltd
R276	4.99K	RR1220P-4991-D-M	4.99K 0.5% 0805 .1 W Thin Film Chip Resistor	Susumu Co Ltd
R277	10K	CR0805-10W-1002FT	10K 1% 0805 .1 W Thick Film Chip Resistor	Venkel
R278	10K	CR0805-10W-1002FT	10K 1% 0805 .1 W Thick Film Chip Resistor	Venkel
R279	4.99K	RR1220P-4991-D-M	4.99K 0.5% 0805 .1 W Thin Film Chip Resistor	Susumu Co Ltd
R280	4.99K	RR1220P-4991-D-M	4.99K 0.5% 0805 .1 W Thin Film Chip Resistor	Susumu Co Ltd
R281	10K	CR0805-10W-1002FT	10K 1% 0805 .1 W Thick Film Chip Resistor	Venkel
R282	4.99K	RR1220P-4991-D-M	4.99K 0.5% 0805 .1 W Thin Film Chip Resistor	Susumu Co Ltd
R283	4.99K	RR1220P-4991-D-M	4.99K 0.5% 0805 .1 W Thin Film Chip Resistor	Susumu Co Ltd
R284	10K	CR0805-10W-1002FT	10K 1% 0805 .1 W Thick Film Chip Resistor	Venkel
R285	10K	CR0805-10W-1002FT	10K 1% 0805 .1 W Thick Film Chip Resistor	Venkel
R286	10K	CR0805-10W-1002FT	10K 1% 0805 .1 W Thick Film Chip Resistor	Venkel
R287	4.99K	RR1220P-4991-D-M	4.99K 0.5% 0805 .1 W Thin Film Chip Resistor	Susumu Co Ltd
R288	3.57K	CR0805-10W-3571FT	3.57K 1% 0805 .1 W Thick Film Chip Resistor	Venkel
R289	3.57K	CR0805-10W-3571FT	3.57K 1% 0805 .1 W Thick Film Chip Resistor	Venkel
R290	3.57K	CR0805-10W-3571FT	3.57K 1% 0805 .1 W Thick Film Chip Resistor	Venkel
R291	4.99K	RR1220P-4991-D-M	4.99K 0.5% 0805 .1 W Thin Film Chip Resistor	Susumu Co Ltd
R292	3.57K	CR0805-10W-3571FT	3.57K 1% 0805 .1 W Thick Film Chip Resistor	Venkel
R293	4.99K	RR1220P-4991-D-M	4.99K 0.5% 0805 .1 W Thin Film Chip Resistor	Susumu Co Ltd
R294	3.57K	CR0805-10W-3571FT	3.57K 1% 0805 .1 W Thick Film Chip Resistor	Venkel
R295	3.57K	CR0805-10W-3571FT	3.57K 1% 0805 .1 W Thick Film Chip Resistor	Venkel
R296	3.57K	CR0805-10W-3571FT	3.57K 1% 0805 .1 W Thick Film Chip Resistor	Venkel
R297	4.99K	RR1220P-4991-D-M	4.99K 0.5% 0805 .1 W Thin Film Chip Resistor	Susumu Co Ltd
R298	3.57K	CR0805-10W-3571FT	3.57K 1% 0805 .1 W Thick Film Chip Resistor	Venkel
R299	4.99K	RR1220P-4991-D-M	4.99K 0.5% 0805 .1 W Thin Film Chip Resistor	Susumu Co Ltd
R300	3.57K	CR0805-10W-3571FT	3.57K 1% 0805 .1 W Thick Film Chip Resistor	Venkel
R301	3.57K	CR0805-10W-3571FT	3.57K 1% 0805 .1 W Thick Film Chip Resistor	Venkel

Table B-1. EVM Bill of Materials

R302	3.57K	CR0805-10W-3571FT	3.57K 1% 0805 .1 W Thick Film Chip Resistor	Venkel
R303	4.99K	RR1220P-4991-D-M	4.99K 0.5% 0805 .1 W Thin Film Chip Resistor	Susumu Co Ltd
R304	3.57K	CR0805-10W-3571FT	3.57K 1% 0805 .1 W Thick Film Chip Resistor	Venkel
R305	4.99K	RR1220P-4991-D-M	4.99K 0.5% 0805 .1 W Thin Film Chip Resistor	Susumu Co Ltd
R306	3.57K	CR0805-10W-3571FT	3.57K 1% 0805 .1 W Thick Film Chip Resistor	Venkel
R307	3.57K	CR0805-10W-3571FT	3.57K 1% 0805 .1 W Thick Film Chip Resistor	Venkel
R308	3.57K	CR0805-10W-3571FT	3.57K 1% 0805 .1 W Thick Film Chip Resistor	Venkel
R309	4.99K	RR1220P-4991-D-M	4.99K 0.5% 0805 .1 W Thin Film Chip Resistor	Susumu Co Ltd
R310	3.57K	CR0805-10W-3571FT	3.57K 1% 0805 .1 W Thick Film Chip Resistor	Venkel
R311	4.99K	RR1220P-4991-D-M	4.99K 0.5% 0805 .1 W Thin Film Chip Resistor	Susumu Co Ltd
R312	3.57K	CR0805-10W-3571FT	3.57K 1% 0805 .1 W Thick Film Chip Resistor	Venkel
R313	3.57K	CR0805-10W-3571FT	3.57K 1% 0805 .1 W Thick Film Chip Resistor	Venkel
R314	3.57K	CR0805-10W-3571FT	3.57K 1% 0805 .1 W Thick Film Chip Resistor	Venkel
R315	4.99K	RR1220P-4991-D-M	4.99K 0.5% 0805 .1 W Thin Film Chip Resistor	Susumu Co Ltd
R316	3.57K	CR0805-10W-3571FT	3.57K 1% 0805 .1 W Thick Film Chip Resistor	Venkel
R317	4.99K	RR1220P-4991-D-M	4.99K 0.5% 0805 .1 W Thin Film Chip Resistor	Susumu Co Ltd
R318	3.57K	CR0805-10W-3571FT	3.57K 1% 0805 .1 W Thick Film Chip Resistor	Venkel
R319	3.57K	CR0805-10W-3571FT	3.57K 1% 0805 .1 W Thick Film Chip Resistor	Venkel
R320	3.57K	CR0805-10W-3571FT	3.57K 1% 0805 .1 W Thick Film Chip Resistor	Venkel
R321	4.99K	RR1220P-4991-D-M	4.99K 0.5% 0805 .1 W Thin Film Chip Resistor	Susumu Co Ltd
R322	3.57K	CR0805-10W-3571FT	3.57K 1% 0805 .1 W Thick Film Chip Resistor	Venkel
R323	3.57K	CR0805-10W-3571FT	3.57K 1% 0805 .1 W Thick Film Chip Resistor	Venkel
R324	100K	CR0805-10W-1003FT	100K 1% 0805 .1 W Thick Film Chip Resistor	Venkel
R325	1.1K	CR0805-10W-1101FT	1.1K 1% 0805 .1 W Thick Film Chip Resistor	Venkel
R326	10K	CR0805-10W-1002FT	10K 1% 0805 .1 W Thick Film Chip Resistor	Venkel
R327	4.99K	RR1220P-4991-D-M	4.99K 0.5% 0805 .1 W Thin Film Chip Resistor	Susumu Co Ltd
R328	10K	CR0805-10W-1002FT	10K 1% 0805 .1 W Thick Film Chip Resistor	Venkel
R329	10K	CR0805-10W-1002FT	10K 1% 0805 .1 W Thick Film Chip Resistor	Venkel
R330	4.99K	RR1220P-4991-D-M	4.99K 0.5% 0805 .1 W Thin Film Chip Resistor	Susumu Co Ltd
R331	10K	CR0805-10W-1002FT	10K 1% 0805 .1 W Thick Film Chip Resistor	Venkel
R332	10K	CR0805-10W-1002FT	10K 1% 0805 .1 W Thick Film Chip Resistor	Venkel
R333		CR0805-10W-2430FT	243 1% 0805 .1 W Thick Film Chip Resistor	Venkel
R334	20K	CR0805-10W-2002FT	20K 1% 0805 .1 W Thick Film Chip Resistor	Venkel
R335	NONE		Do Not Install	
R336	NONE		Do Not Install	
R337	0.0	CR0805-10W-000T	ZERO OHM Jumper 0805	Venkel
R338	0.0	CR0805-10W-000T	ZERO OHM Jumper 0805	Venkel
R339	NONE		Do Not Install	
R340	NONE		Do Not Install	
R341	NONE		Do Not Install	
R342	NONE		Do Not Install	
R343	NONE		Do Not Install	
RV1	1K	CA6V-SMD-1K-WT	6mm Trimmer 1K with White Knob	Vimex
RV2	1K	CA6V-SMD-1K-WT	6mm Trimmer 1K with White Knob	Vimex
RV3	10K	SL101N-A-10K-L2.5	10K Audio Taper Slide Pot	Venkel
RV4	10K	SL101N-A-10K-L2.5	10K Audio Taper Slide Pot	Venkel
SW1		TL3301NF160QG/TR	Surface Mount Tact Switch	E-Switch
SW2		218-8LPST	8 Position Half Pitch Dip Switch	CTS
SW3		218-8LPST	8 Position Half Pitch Dip Switch	CTS
T1		TTWB1010	1:1 Wide Band RF Transformers Surface Mount	Coilcraft
T2		TTWB1010	1:1 Wide Band RF Transformers Surface Mount	Coilcraft

DSPAUDIOEVM Users Guide, Rev. 2.4

Table B-1. EVM Bill of Materials

T3		TTWB1010	1:1 Wide Band RF Transformers Surface Mount	Coilcraft
T4		TTWB1010	1:1 Wide Band RF Transformers Surface Mount	Coilcraft
T5		TTWB1010	1:1 Wide Band RF Transformers Surface Mount	Coilcraft
T6		TTWB1010	1:1 Wide Band RF Transformers Surface Mount	Coilcraft
TP6	GND	PJ-202-30	Test Point .300"	Components Corp.
TP7		AFM2-08SG6MM/3.55MM	4 X 2 Header 2.54mm on center 6 mm/3.0mm	Vimex
TP9	GND	PJ-202-30	Test Point .300"	Components Corp.
TP10		AFM2-08SG6MM/3.55MM	4 X 2 Header 2.54mm on center 6 mm/3.0mm	Vimex
TP11	GND	PJ-202-30	Test Point .300"	Components Corp.
U1		SN65220	Single Universal Serial Bus Port Transient Suppressor DBV SOT-23-6	TI
U2		MAX232D	Dual EIA-232 Driver/Receiver SOIC-16.150"	Maxim
U3		74LVXC4245QSC	8-Bit Dual Supply Configurable Volt Interface Transceiver 3-STATE Outputs QSOP 16	Fairchild
U4		74LVXC4245QSC	8-Bit Dual Supply Configurable Volt Interface Transceiver 3-STATE Outputs QSOP 16	Fairchild
U5		74VHCT08M	Quad 2 Input AND Gate SOIC-14	Fairchild
U6		74VHCT125M	Quad Buffer with 3-STATE Outputs SOIC-14	Fairchild
U7		74LCX07D	Low Voltage Hex Buffer Open Drain Outputs SOIC-14	Fairchild
U8		FST3257	Quad 2:1 Multiplexer/De Multiplexer Bus Switch	ON Semiconductor
U9		DS1818R-5	3.3 Econo Reset with Push Button SOT23	Dallas
U10		MC68HC908JB16FA	MPU	Motorola
U11		74VHC00M	Quad 2-Input NAND Gate SOIC-14	Fairchild
U12		74VHC32M	Quad 2-Input OR Gate SOIC-14	Fairchild
U13		74VHCT125M	Quad Buffer with 3-STATE Outputs SOIC-14	Fairchild
U14		FST3257	Quad 2:1 Multiplexer/De Multiplexer Bus Switch	ON Semiconductor
U15		MC68HC908GP32CFB	MPU	Motorola
U16		GP1FA550TZ	SPDIF Optical Transmitter	Sharp
U17		AK4101VQ	Quad Outputs 192KHZ 24-Bit DIT 44 Pin LQFP (0.8mm pitch)	AKM
U18		74VHCT125M	Quad Buffer with 3-STATE Outputs SOIC-14	Fairchild
U19		74VHCT125M	Quad Buffer with 3-STATE Outputs SOIC-14	Fairchild
U20		74VHCT125M	Quad Buffer with 3-STATE Outputs SOIC-14	Fairchild
U21		74VHC74M	Dual D-Type Flip-Flop with Preset and Clear SOIC-14	Fairchild
U22		74VHCT08M	Quad 2 Input AND Gate SOIC-14	Fairchild
U23		GP1FA550RZ	SPDIF Optical Receiver	Sharp
U24		NC7SZU04M5	TinyLogic UHS Unbuffered Inverter SOT 23-5	Fairchild
U25		MAX8211CSA	Microprocessor Voltage Monitors with Programmable Voltage Detection SOIC-8	Maxim
U26		GP1FA550RZ	SPDIF Optical Receiver	Sharp
U27		AK4114VQ	High Feature 192KHz 24-Bit Digital Audio Interface Transceiver 48 pin LQFP (0.5mm pitch)	AKM
U28		NE5532AD8	High Performance Low Noise Dual Operational Amplifier DMP8, SOIC-8	Philips
U29		AK5380VT	96KHz 24-Bit ADC with Single-ended Input 16 pin TSSOP	AKM
U30		AK4355VF	192KHz 24-Bit 6ch DAC for DVD -Audio 28 pin VSOP (0.65mm pitch)	AKM
U31		AK4355VF	192KHz 24-Bit 6ch DAC for DVD -Audio 28 pin VSOP (0.65mm pitch)	AKM
U32		NE5532AD8	High Performance Low Noise Dual Operational Amplifier DMP8, SOIC-8	Philips
U33		NE5532AD8	High Performance Low Noise Dual Operational Amplifier DMP8, SOIC-8	Philips
U34		AK5380VT	96KHz 24-Bit ADC with Single-ended Input 16 pin TSSOP	AKM

Table B-1. EVM Bill of Materials

U35		NE5532AD8	High Performance Low Noise Dual Operational Amplifier DMP8, SOIC-8	Philips
U36		NE5532AD8	High Performance Low Noise Dual Operational Amplifier DMP8, SOIC-8	Philips
U37		NE5532AD8	High Performance Low Noise Dual Operational Amplifier DMP8, SOIC-8	Philips
U38		NE5532AD8	High Performance Low Noise Dual Operational Amplifier DMP8, SOIC-8	Philips
U39		NE5532AD8	High Performance Low Noise Dual Operational Amplifier DMP8, SOIC-8	Philips
U40		NE5532AD8	High Performance Low Noise Dual Operational Amplifier DMP8, SOIC-8	Philips
U41		NE5532AD8	High Performance Low Noise Dual Operational Amplifier DMP8, SOIC-8	Philips
U42		NE5532AD8	High Performance Low Noise Dual Operational Amplifier DMP8, SOIC-8	Philips
U43		NE5532AD8	High Performance Low Noise Dual Operational Amplifier DMP8, SOIC-8	Philips
U44		LM1117MP-ADJ	3 Terminal Adjustable Positive LDO Regulator SOT223	NSC
U45		LM1117MP-ADJ	4 Terminal Adjustable Positive LDO Regulator SOT223	NSC
U46		NC7SZU04M5	TinyLogic UHS Unbuffered Inverter SOT 23-5	Fairchild
U47		LM337IMP	3 Terminal Adjustable Negative Regulator SOT223	NSC
U48		74LVXC3245QSC	8-Bit Dual Supply Configurable Volt Interface Transceiver 3-STATE Outputs QSOP 16	Fairchild
U49	4.7V	TPS79147DBVR	Ultra Low Noise High PSRR Fast RF 4.7V 100-MA, LDO Linear Regulator SOT23-5	TI
U50	4.7V	TPS79147DBVR	Ultra Low Noise High PSRR Fast RF 4.7V 100-MA, LDO Linear Regulator SOT23-5	TI
U51	4.7V	TPS79147DBVR	Ultra Low Noise High PSRR Fast RF 4.7V 100-MA, LDO Linear Regulator SOT23-5	TI
U52	4.7V	TPS79147DBVR	Ultra Low Noise High PSRR Fast RF 4.7V 100-MA, LDO Linear Regulator SOT23-5	TI
X1	9.8304MHZ	HCM49-9.8304MABJT	HCM49 Series Surface Mount Crystals 9.8304MHZ	Citizen America
X2	24.576MHZ	HCM49-24.576MABJT	HCM49 Series Surface Mount Crystals 24.576MHZ	Citizen America
X3	11.0592MHZ	HCM49-11.0592MABJT	HCM49 Series Surface Mount Crystals 11.0592MHZ	Citizen America
X4	12.000MHZ	HCM49-12.000MABJT	HCM49 Series Surface Mount Crystals 12.000MHZ	Citizen America

Supporting Documentation

Find device user manual/datasheets at

http://e-www.motorola.com/webapp/sps/library/docu_lib.jsp

56300 Family Manual

<http://e-www.motorola.com/brdata/PDFDB/docs/DSP56300FM.pdf>

<http://e-www.motorola.com/brdata/PDFDB/docs/DSP56300FMAD.pdf>

56362

<http://e-www.motorola.com/brdata/PDFDB/docs/DSP56362.pdf>

<http://e-www.motorola.com/brdata/PDFDB/docs/DSP56362UM.pdf>

56364

<http://e-www.motorola.com/brdata/PDFDB/docs/DSP56364.pdf>

<http://e-www.motorola.com/brdata/PDFDB/docs/DSP56364UM.pdf>

56366

<http://e-www.motorola.com/brdata/PDFDB/docs/DSP56366.pdf>

<http://e-www.motorola.com/brdata/PDFDB/docs/DSP56366UM.pdf>

56367

<http://e-www.motorola.com/brdata/PDFDB/docs/DSP56367UM.pdf>

AKM parts

www.akm.com

How to Reach Us:

Home Page:

www.freescale.com

E-mail:

support@freescale.com

USA/Europe or Locations Not Listed:

Freescale Semiconductor
Technical Information Center, CH370
1300 N. Alma School Road
Chandler, Arizona 85224
+1-800-521-6274 or +1-480-768-2130
support@freescale.com

Europe, Middle East, and Africa:

Freescale Halbleiter Deutschland GmbH
Technical Information Center
Schatzbogen 7
81829 Muenchen, Germany
+44 1296 380 456 (English)
+46 8 52200080 (English)
+49 89 92103 559 (German)
+33 1 69 35 48 48 (French)
support@freescale.com

Japan:

Freescale Semiconductor Japan Ltd.
Technical Information Center
3-20-1, Minami-Azabu, Minato-ku
Tokyo 106-0047, Japan
0120 191014 or +81 3 3440 3569
support.japan@freescale.com

Asia/Pacific:

Freescale Semiconductor Hong Kong Ltd.
Technical Information Center
2 Dai King Street
Tai Po Industrial Estate
Tai Po, N.T., Hong Kong
+800 2666 8080
support.asia@freescale.com

For Literature Requests Only:

Freescale Semiconductor Literature Distribution Center
P.O. Box 5405
Denver, Colorado 80217
1-800-441-2447 or 303-675-2140
Fax: 303-675-2150
LDCForFreescaleSemiconductor@hibbertgroup.com

Information in this document is provided solely to enable system and software implementers to use Freescale Semiconductor products. There are no express or implied copyright licenses granted hereunder to design or fabricate any integrated circuits or integrated circuits based on the information in this document.

Freescale Semiconductor reserves the right to make changes without further notice to any products herein. Freescale Semiconductor makes no warranty, representation or guarantee regarding the suitability of its products for any particular purpose, nor does Freescale Semiconductor assume any liability arising out of the application or use of any product or circuit, and specifically disclaims any and all liability, including without limitation consequential or incidental damages. "Typical" parameters that may be provided in Freescale Semiconductor data sheets and/or specifications can and do vary in different applications and actual performance may vary over time. All operating parameters, including "Typicals", must be validated for each customer application by customer's technical experts. Freescale Semiconductor does not convey any license under its patent rights nor the rights of others. Freescale Semiconductor products are not designed, intended, or authorized for use as components in systems intended for surgical implant into the body, or other applications intended to support or sustain life, or for any other application in which the failure of the Freescale Semiconductor product could create a situation where personal injury or death may occur. Should Buyer purchase or use Freescale Semiconductor products for any such unintended or unauthorized application, Buyer shall indemnify and hold Freescale Semiconductor and its officers, employees, subsidiaries, affiliates, and distributors harmless against all claims, costs, damages, and expenses, and reasonable attorney fees arising out of, directly or indirectly, any claim of personal injury or death associated with such unintended or unauthorized use, even if such claim alleges that Freescale Semiconductor was negligent regarding the design or manufacture of the part.



Freescale™ and the Freescale logo are trademarks of Freescale Semiconductor, Inc. All other product or service names are the property of their respective owners.

© Freescale Semiconductor, Inc. 2004. All rights reserved.



Стандарт Электрон Связь

Мы молодая и активно развивающаяся компания в области поставок электронных компонентов. Мы поставляем электронные компоненты отечественного и импортного производства напрямую от производителей и с крупнейших складов мира.

Благодаря сотрудничеству с мировыми поставщиками мы осуществляем комплексные и плановые поставки широчайшего спектра электронных компонентов.

Собственная эффективная логистика и склад в обеспечивает надежную поставку продукции в точно указанные сроки по всей России.

Мы осуществляем техническую поддержку нашим клиентам и предпродажную проверку качества продукции. На все поставляемые продукты мы предоставляем гарантию .

Осуществляем поставки продукции под контролем ВП МО РФ на предприятия военно-промышленного комплекса России , а также работаем в рамках 275 ФЗ с открытием отдельных счетов в уполномоченном банке. Система менеджмента качества компании соответствует требованиям ГОСТ ISO 9001.

Минимальные сроки поставки, гибкие цены, неограниченный ассортимент и индивидуальный подход к клиентам являются основой для выстраивания долгосрочного и эффективного сотрудничества с предприятиями радиоэлектронной промышленности, предприятиями ВПК и научно-исследовательскими институтами России.

С нами вы становитесь еще успешнее!

Наши контакты:

Телефон: +7 812 627 14 35

Электронная почта: sales@st-electron.ru

Адрес: 198099, Санкт-Петербург,
Промышленная ул, дом № 19, литера Н,
помещение 100-Н Офис 331