

**SERIES:** SDI50-UD | **DESCRIPTION:** AC-DC POWER SUPPLY

**FEATURES**

- DoE Level VI, CoC Tier 2 efficiency
- 50 W power
- universal input (90~264 Vac)
- compact size
- single regulated output from 9~48 Vdc
- over voltage and short circuit protections
- UL/cUL and PSE safety approvals
- custom designs available
- certified to 60950-1 and 62368-1 standards



| MODEL       | output voltage<br>(Vdc) | output current<br>max<br>(A) | output power<br>max<br>(W) | ripple and noise <sup>1</sup><br>max<br>(mVp-p) | efficiency level <sup>2</sup> |
|-------------|-------------------------|------------------------------|----------------------------|---|-------------------------------|
| SDI50-9-UD  | 9                       | 5                            | 45                         | 100   | VI                            |
| SDI50-12-UD | 12                      | 4.2                          | 50                         | 120   | VI                            |
| SDI50-15-UD | 15                      | 3.34                         | 50                         | 150   | VI                            |
| SDI50-18-UD | 18                      | 2.78                         | 50                         | 180   | VI                            |
| SDI50-19-UD | 19                      | 2.64                         | 50                         | 190   | VI                            |
| SDI50-24-UD | 24                      | 2.1                          | 50                         | 240   | VI                            |
| SDI50-48-UD | 48                      | 1.05                         | 50                         | 480   | VI                            |

Notes: 1. At full load, nominal input, 20 MHz bandwidth oscilloscope, each output terminated with 0.1 µF multilayer ceramic and 10 µF low ESR electrolytic capacitors.  
2. CoC Tier 2 compliant

**PART NUMBER KEY**

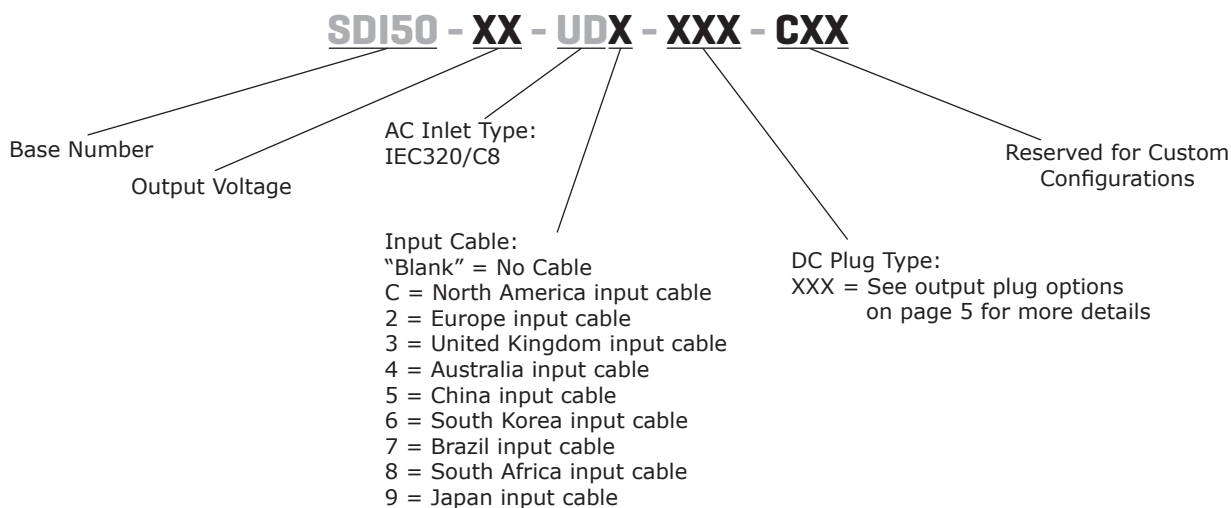

## INPUT

| parameter                 | conditions/description                        | min | typ | max          | units  |
|---------------------------|---|-----|-----|--------------|--------|
| voltage                   |   | 90  |     | 264          | Vac    |
| frequency                 |   | 47  |     | 63           | Hz     |
| current                   |   |     |     | 1.2          | A      |
| inrush current            | at 230 Vac, full load, 25°C, cold start       |     |     | 70           | A      |
| leakage current           |   |     |     | 0.25         | mA     |
| no load power consumption | at 230 Vac<br>9 Vdc model<br>all other models |     |     | 0.10<br>0.15 | W<br>W |

## OUTPUT

| parameter  | conditions/description | min | typ | max | units |
|------------|------------------------|-----|-----|-----|-------|
| regulation |                        |     | ±5  |     | %     |

## PROTECTIONS

| parameter                | conditions/description          | min | typ | max | units |
|--------------------------|---------------------------------|-----|-----|-----|-------|
| over voltage protection  | output latch off                |     |     | 180 | %     |
| over current protection  | output shut down, auto recovery |     |     | 180 | %     |
| short circuit protection | output shut down, auto recovery |     |     |     |       |

## SAFETY & COMPLIANCE

| parameter            | conditions/description                | min     | typ   | max | units |
|----------------------|---------------------------------------|---------|-------|-----|-------|
| isolation voltage    | input to output at 10 mA for 1 minute |         | 3,000 |     | Vac   |
| isolation resistance | input to output at 500 Vdc            | 10      |       |     | MΩ    |
| safety approvals     | UL/cUL (60950-1, 62368-1), PSE, LPS   |         |       |     |       |
| EMI/EMC              | FCC Part 15B Class B, CE              |         |       |     |       |
| MTBF                 | as per Telcordia SR-332, 25°C         | 300,000 |       |     | hours |
| RoHS                 | yes                                   |         |       |     |       |

## ENVIRONMENTAL

| parameter             | conditions/description | min | typ | max | units |
|-----------------------|------------------------|-----|-----|-----|-------|
| operating temperature |                        | 0   |     | 40  | °C    |
| storage temperature   |                        | -20 |     | 80  | °C    |
| operating humidity    | non-condensing         | 20  |     | 80  | %     |
| storage humidity      | non-condensing         | 10  |     | 90  | %     |

## MECHANICAL

| parameter  | conditions/description | min | typ | max | units |
|------------|------------------------|-----|-----|-----|-------|
| dimensions | 115 x 53 x 38          |     |     |     | mm    |
| inlet plug | IEC320/C8              |     |     |     |       |
| weight     | without ac cord        |     | 310 |     | g     |

## MECHANICAL DRAWING

units: mm  
tolerance: ±1.0 mm

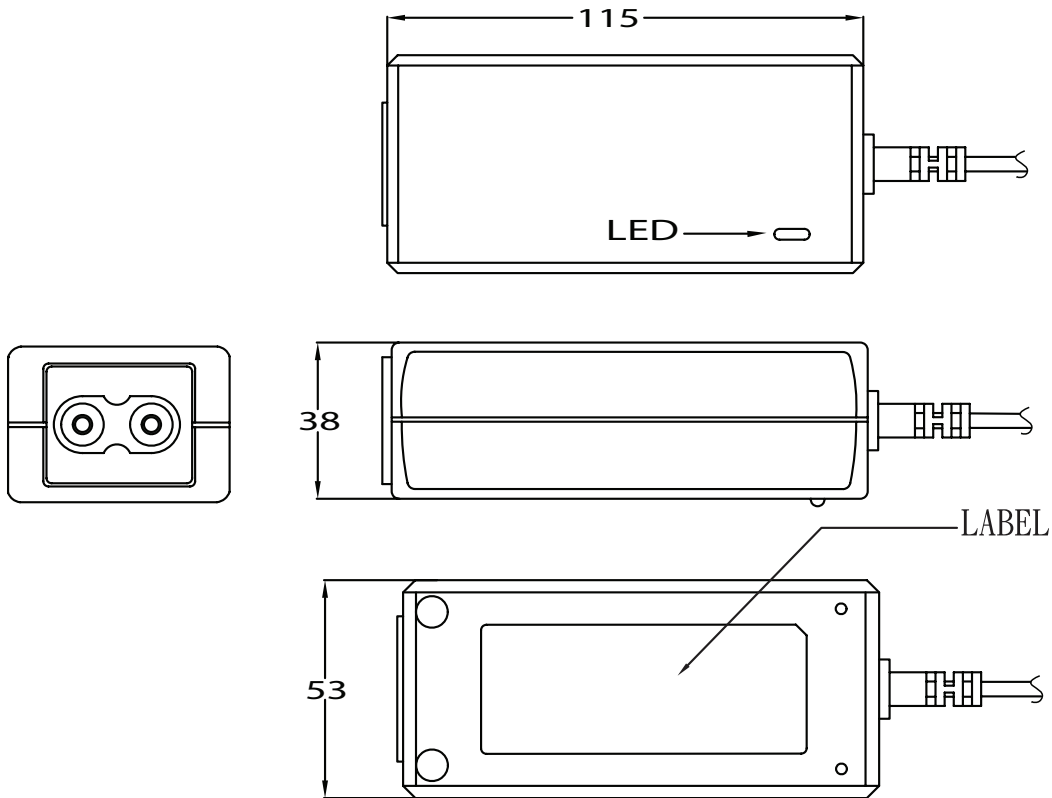

## DC CORD

units: mm

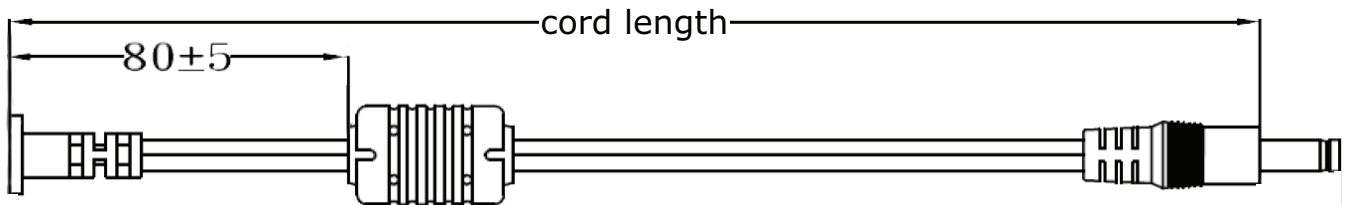
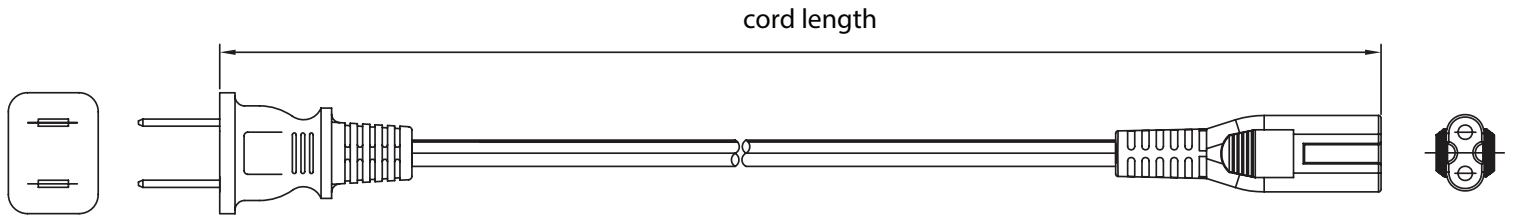

**Table 1**

| MODEL NO.   | CABLE          | CORD LENGTH  |
|-------------|----------------|--------------|
| SDI50-9-UD  | UL2468, 18 AWG | 1,500 mm ±30 |
| SDI50-12-UD | UL2468, 18 AWG | 1,500 mm ±30 |
| SDI50-15-UD | UL2468, 18 AWG | 1,500 mm ±30 |
| SDI50-18-UD | UL2468, 18 AWG | 1,500 mm ±30 |
| SDI50-19-UD | UL2468, 18 AWG | 1,500 mm ±30 |
| SDI50-24-UD | UL2468, 18 AWG | 1,500 mm ±30 |
| SDI50-48-UD | UL2468, 20 AWG | 1,500 mm ±30 |

## AC CORD

units: mm



### NORTH AMERICA

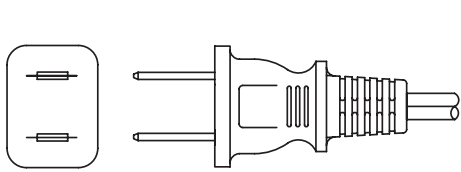

### EUROPE

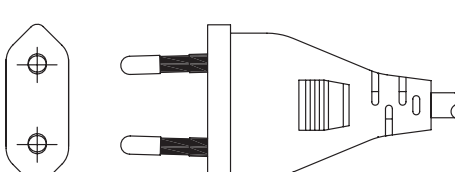

### UNITED KINGDOM

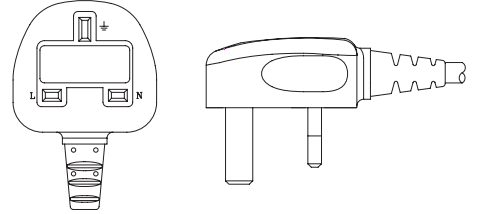

### AUSTRALIA

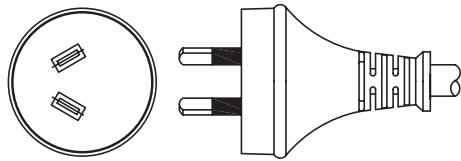

### CHINA

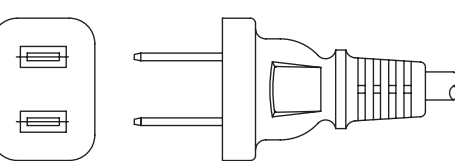

### SOUTH KOREA

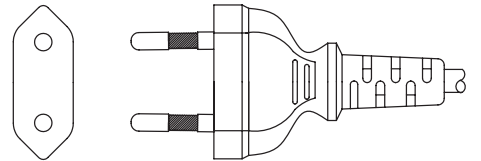

### BRAZIL

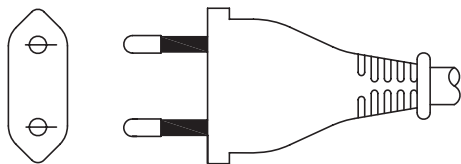

### SOUTH AFRICA

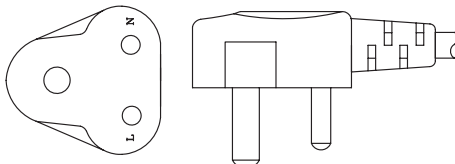

### JAPAN

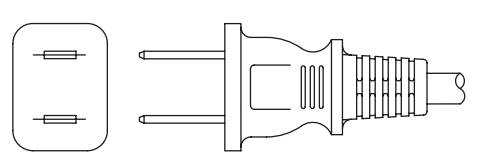

**Table 2**

| AC INPUT       | CORD LENGTH  |
|----------------|--------------|
| North America  | 1,830 mm ±50 |
| Europe         | 1,830 mm ±50 |
| United Kingdom | 1,830 mm ±30 |
| Australia      | 1,830 mm ±30 |
| China          | 1,830 mm ±30 |
| South Korea    | 1,830 mm ±50 |
| Brazil         | 1,830 mm ±30 |
| South Africa   | 1,830 mm ±50 |
| Japan          | 1,830 mm ±50 |

## DC PLUG TYPE PART NUMBER KEY

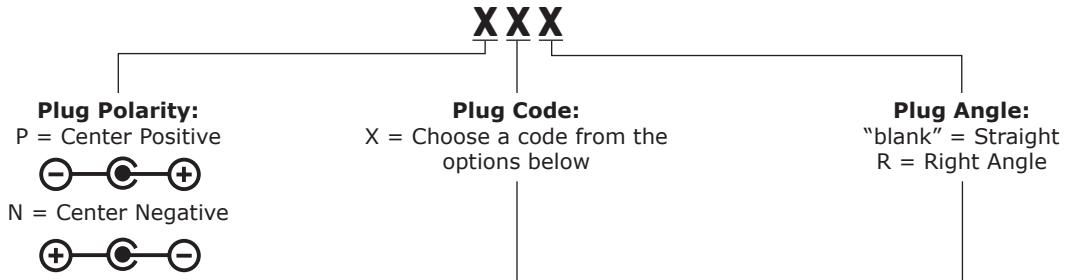

| Plug Polarity |             | Code   |                   | Dimensions (mm) |      |     | Plug Angle |       |
|---------------|-------------|--------|-------------------|-----------------|------|-----|------------|-------|
| Center Pos.   | Center Neg. | Option | Type              | A               | B    | C   | Straight   | Right |
| •             | •           | 5      | Standard          | 5.5             | 2.1  | 9.5 | •          | •     |
| •             | •           | 6      | Standard          | 5.5             | 2.5  | 9.5 | •          | •     |
| •             | •           | 7      | Standard          | 3.5             | 1.35 | 9.5 | •          | •     |
| •             | •           | 8      | Standard          | 3.8             | 1.35 | 9.5 | •          | •     |
| •             | •           | 9      | Standard          | 3.8             | 1.05 | 9.5 | •          | •     |
| •             | •           | 10     | Locking           | 5.5             | 2.1  | 9.5 | •          | N/A   |
| •             | •           | 11     | Locking           | 5.5             | 2.5  | 9.5 | •          | N/A   |
| •             | •           | 12     | EIAJ-1            | 2.35            | 0.7  | 9.5 | •          | •     |
| •             | •           | 13     | EIAJ-2            | 4.0             | 1.7  | 9.5 | •          | •     |
| •             | •           | 14     | EIAJ-3            | 4.75            | 1.7  | 9.5 | •          | •     |
| N/A           | N/A         | ST     | Stripped & Tinned |                 |      | N/A | N/A        |       |

Note: 1. Contact CUI for additional plug options

### Standard

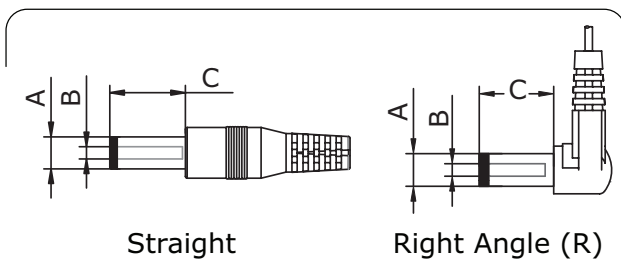

### EIAJ

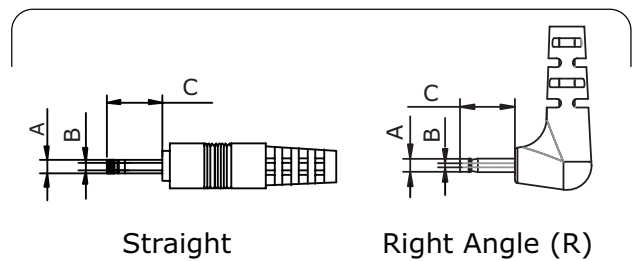

### Locking

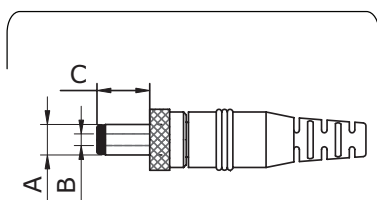

### Stripped & Tinned

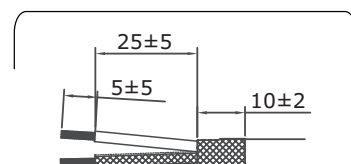

## REVISION HISTORY

---

| rev. | description                | date       |
|------|----------------------------|------------|
| 1.0  | initial release            | 05/13/2015 |
| 1.01 | updated datasheet          | 09/15/2016 |
| 1.02 | added 62368-1 standard     | 08/31/2018 |
| 1.03 | removed GS safety approval | 03/02/2020 |

The revision history provided is for informational purposes only and is believed to be accurate.



**Headquarters**  
20050 SW 112th Ave.  
Tualatin, OR 97062  
**800.275.4899**

Fax 503.612.2383  
**cui.com**  
techsupport@cui.com

CUI offers a two (2) year limited warranty. Complete warranty information is listed on our website.

CUI reserves the right to make changes to the product at any time without notice. Information provided by CUI is believed to be accurate and reliable. However, no responsibility is assumed by CUI for its use, nor for any infringements of patents or other rights of third parties which may result from its use.

CUI products are not authorized or warranted for use as critical components in equipment that requires an extremely high level of reliability. A critical component is any component of a life support device or system whose failure to perform can be reasonably expected to cause the failure of the life support device or system, or to affect its safety or effectiveness.



## Стандарт Электрон Связь

Мы молодая и активно развивающаяся компания в области поставок электронных компонентов. Мы поставляем электронные компоненты отечественного и импортного производства напрямую от производителей и с крупнейших складов мира.

Благодаря сотрудничеству с мировыми поставщиками мы осуществляем комплексные и плановые поставки широчайшего спектра электронных компонентов.

Собственная эффективная логистика и склад в обеспечивает надежную поставку продукции в точно указанные сроки по всей России.

Мы осуществляем техническую поддержку нашим клиентам и предпродажную проверку качества продукции. На все поставляемые продукты мы предоставляем гарантию .

Осуществляем поставки продукции под контролем ВП МО РФ на предприятия военно-промышленного комплекса России , а также работаем в рамках 275 ФЗ с открытием отдельных счетов в уполномоченном банке. Система менеджмента качества компании соответствует требованиям ГОСТ ISO 9001.

Минимальные сроки поставки, гибкие цены, неограниченный ассортимент и индивидуальный подход к клиентам являются основой для выстраивания долгосрочного и эффективного сотрудничества с предприятиями радиоэлектронной промышленности, предприятиями ВПК и научно-исследовательскими институтами России.

С нами вы становитесь еще успешнее!

### Наши контакты:

**Телефон:** +7 812 627 14 35

**Электронная почта:** [sales@st-electron.ru](mailto:sales@st-electron.ru)

**Адрес:** 198099, Санкт-Петербург,  
Промышленная ул, дом № 19, литера Н,  
помещение 100-Н Офис 331