

SERIES: SDI50-UD | **DESCRIPTION:** AC-DC POWER SUPPLY

FEATURES

- DoE Level VI, CoC Tier 2 efficiency
- 50 W power
- universal input (90~264 Vac)
- compact size
- single regulated output from 9~48 Vdc
- over voltage and short circuit protections
- UL/cUL and PSE safety approvals
- custom designs available
- certified to 60950-1 and 62368-1 standards



MODEL	output voltage	output current max	output power max	ripple and noise ¹ max	efficiency level ²
	(Vdc)	(A)	(W)	(mVp-p)	
SDI50-9-UD	9	5	45	100	VI
SDI50-12-UD	12	4.2	50	120	VI
SDI50-15-UD	15	3.34	50	150	VI
SDI50-18-UD	18	2.78	50	180	VI
SDI50-19-UD	19	2.64	50	190	VI
SDI50-24-UD	24	2.1	50	240	VI
SDI50-48-UD	48	1.05	50	480	VI

Notes: 1. At full load, nominal input, 20 MHz bandwidth oscilloscope, each output terminated with 0.1 µF multilayer ceramic and 10 µF low ESR electrolytic capacitors.
2. CoC Tier 2 compliant

PART NUMBER KEY

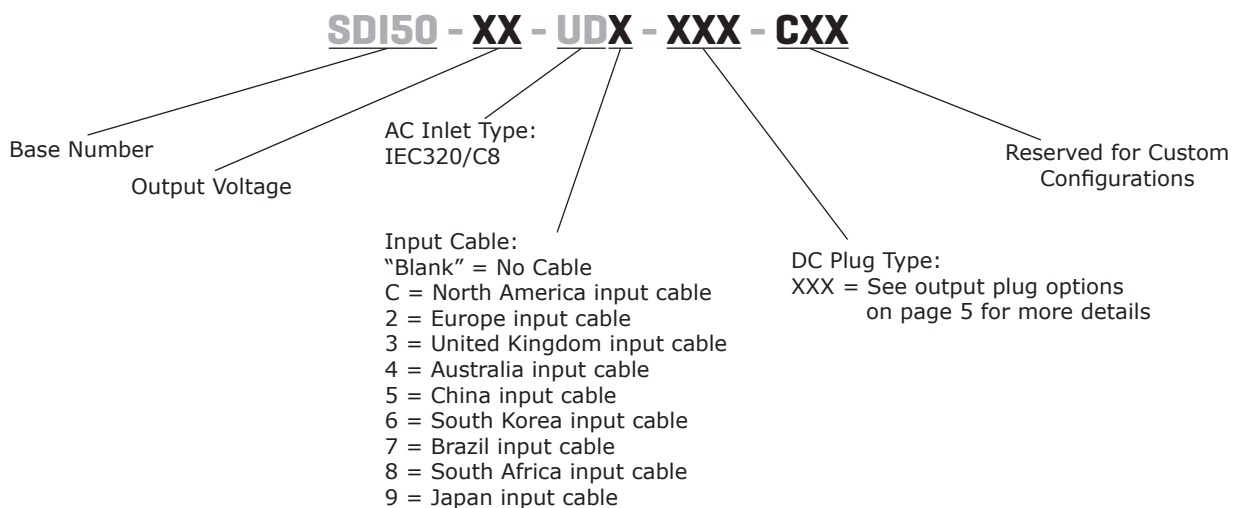

INPUT

parameter	conditions/description	min	typ	max	units
voltage		90		264	Vac
frequency		47		63	Hz
current				1.2	A
inrush current	at 230 Vac, full load, 25°C, cold start			70	A
leakage current				0.25	mA
no load power consumption	at 230 Vac 9 Vdc model all other models			0.10 0.15	W W

OUTPUT

parameter	conditions/description	min	typ	max	units
regulation			±5		%

PROTECTIONS

parameter	conditions/description	min	typ	max	units
over voltage protection	output latch off			180	%
over current protection	output shut down, auto recovery			180	%
short circuit protection	output shut down, auto recovery				

SAFETY & COMPLIANCE

parameter	conditions/description	min	typ	max	units
isolation voltage	input to output at 10 mA for 1 minute		3,000		Vac
isolation resistance	input to output at 500 Vdc	10			MΩ
safety approvals	UL/cUL (60950-1, 62368-1), PSE, LPS				
EMI/EMC	FCC Part 15B Class B, CE				
MTBF	as per Telcordia SR-332, 25°C	300,000			hours
RoHS	yes				

ENVIRONMENTAL

parameter	conditions/description	min	typ	max	units
operating temperature		0		40	°C
storage temperature		-20		80	°C
operating humidity	non-condensing	20		80	%
storage humidity	non-condensing	10		90	%

MECHANICAL

parameter	conditions/description	min	typ	max	units
dimensions	115 x 53 x 38				mm
inlet plug	IEC320/C8				
weight	without ac cord		310		g

MECHANICAL DRAWING

units: mm
tolerance: ±1.0 mm



DC CORD

units: mm



Table 1

MODEL NO.	CABLE	CORD LENGTH
SDI50-9-UD	UL2468, 18 AWG	1,500 mm ±30
SDI50-12-UD	UL2468, 18 AWG	1,500 mm ±30
SDI50-15-UD	UL2468, 18 AWG	1,500 mm ±30
SDI50-18-UD	UL2468, 18 AWG	1,500 mm ±30
SDI50-19-UD	UL2468, 18 AWG	1,500 mm ±30
SDI50-24-UD	UL2468, 18 AWG	1,500 mm ±30
SDI50-48-UD	UL2468, 20 AWG	1,500 mm ±30

AC CORD

units: mm



NORTH AMERICA



EUROPE

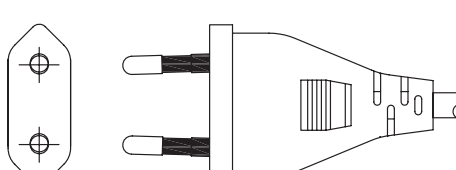

UNITED KINGDOM

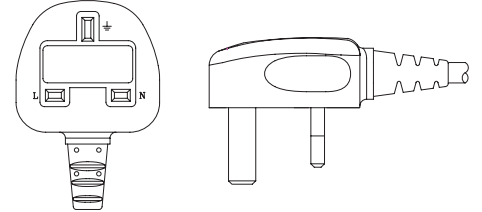

AUSTRALIA

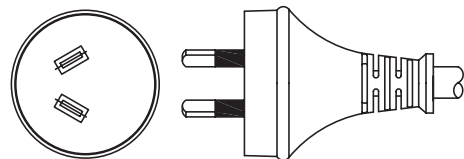

CHINA

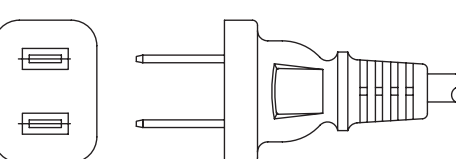

SOUTH KOREA

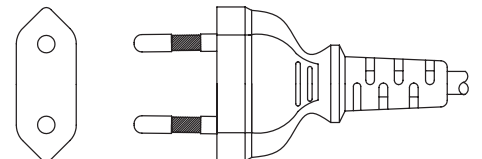

BRAZIL

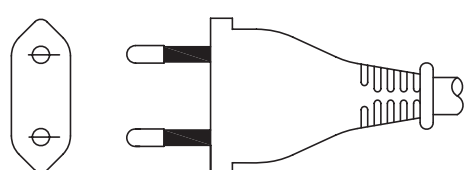

SOUTH AFRICA

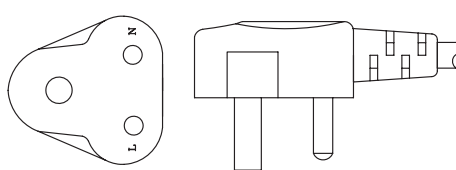

JAPAN

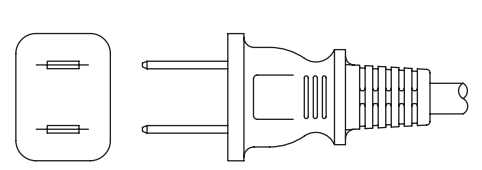

Table 2

AC INPUT	CORD LENGTH
North America	1,830 mm ±50
Europe	1,830 mm ±50
United Kingdom	1,830 mm ±30
Australia	1,830 mm ±30
China	1,830 mm ±30
South Korea	1,830 mm ±50
Brazil	1,830 mm ±30
South Africa	1,830 mm ±50
Japan	1,830 mm ±50

DC PLUG TYPE PART NUMBER KEY



Plug Polarity		Code		Dimensions (mm)			Plug Angle	
Center Pos.	Center Neg.	Option	Type	A	B	C	Straight	Right
•		5	Standard	5.5	2.1	9.5	•	•
•		6	Standard	5.5	2.5	9.5	•	•
•		7	Standard	3.5	1.35	9.5	•	•
•		8	Standard	3.8	1.35	9.5	•	•
•		9	Standard	3.8	1.05	9.5	•	•
•		10	Locking	5.5	2.1	9.5	•	N/A
•		11	Locking	5.5	2.5	9.5	•	N/A
•		12	EIAJ-1	2.35	0.7	9.5	•	•
•		13	EIAJ-2	4.0	1.7	9.5	•	•
•		14	EIAJ-3	4.75	1.7	9.5	•	•
N/A	N/A	ST	Stripped & Tinned			N/A	N/A	

Note: 1. Contact CUI for additional plug options

Standard



EIAJ



Locking



Stripped & Tinned



REVISION HISTORY

rev.	description	date
1.0	initial release	05/13/2015
1.01	updated datasheet	09/15/2016
1.02	added 62368-1 standard	08/31/2018
1.03	removed GS safety approval	03/02/2020

The revision history provided is for informational purposes only and is believed to be accurate.



Headquarters
20050 SW 112th Ave.
Tualatin, OR 97062
800.275.4899

Fax 503.612.2383
cui.com
techsupport@cui.com

CUI offers a two (2) year limited warranty. Complete warranty information is listed on our website.

CUI reserves the right to make changes to the product at any time without notice. Information provided by CUI is believed to be accurate and reliable. However, no responsibility is assumed by CUI for its use, nor for any infringements of patents or other rights of third parties which may result from its use.

CUI products are not authorized or warranted for use as critical components in equipment that requires an extremely high level of reliability. A critical component is any component of a life support device or system whose failure to perform can be reasonably expected to cause the failure of the life support device or system, or to affect its safety or effectiveness.



Стандарт Электрон Связь

Мы молодая и активно развивающаяся компания в области поставок электронных компонентов. Мы поставляем электронные компоненты отечественного и импортного производства напрямую от производителей и с крупнейших складов мира.

Благодаря сотрудничеству с мировыми поставщиками мы осуществляем комплексные и плановые поставки широчайшего спектра электронных компонентов.

Собственная эффективная логистика и склад в обеспечивает надежную поставку продукции в точно указанные сроки по всей России.

Мы осуществляем техническую поддержку нашим клиентам и предпродажную проверку качества продукции. На все поставляемые продукты мы предоставляем гарантию .

Осуществляем поставки продукции под контролем ВП МО РФ на предприятия военно-промышленного комплекса России , а также работаем в рамках 275 ФЗ с открытием отдельных счетов в уполномоченном банке. Система менеджмента качества компании соответствует требованиям ГОСТ ISO 9001.

Минимальные сроки поставки, гибкие цены, неограниченный ассортимент и индивидуальный подход к клиентам являются основой для выстраивания долгосрочного и эффективного сотрудничества с предприятиями радиоэлектронной промышленности, предприятиями ВПК и научно-исследовательскими институтами России.

С нами вы становитесь еще успешнее!

Наши контакты:

Телефон: +7 812 627 14 35

Электронная почта: sales@st-electron.ru

Адрес: 198099, Санкт-Петербург,
Промышленная ул, дом № 19, литера Н,
помещение 100-Н Офис 331